





Receba

As nossas **NOVIDADES**
no seu correio electrónico,
com a máxima comodidade

Informação sempre actualizada em,
www.lizotel.pt

encomendas

online  www.lizotel.pt | geral@lizotel.pt

RECEIVE

Our news in your email,
with the maximum comfort.

Always updated information on,
www.lizotel.pt

Orders online 24h
www.lizotel.pt | geral@lizotel.pt

RECIBIR

*nuestras noticias en su e-mail,
con la máxima comodidad.*

*La información siempre actualizada en,
www.lizotel.pt*

*Orders online 24h
www.lizotel.pt | geral@lizotel.pt*

RECEVEZ

*nos nouveautés par e-mail,
avec un maximum de facilité.*

*Informations mises à jour,
www.lizotel.pt*

*Commandes online 24h
www.lizotel.pt | geral@lizotel.pt*



A Lizotel é uma marca implantada há 17 anos no sector de restauração, hotelaria e catering. Orgulha-se em comercializar produtos de qualidade, tendo sempre em conta a satisfação do cliente. Para o efeito, dispõe de uma grande diversidade de oferta e uma rápida logística, uma vez que o seu negócio, é a nossa prioridade. Os produtos Lizotel são pensados para servir da melhor forma os profissionais deste tão competitivo sector. A inovação incutida na cultura Lizotel, obriga a uma maior qualidade nos produtos garantindo assim durabilidade, versatilidade, manutenção e ergonomia. Os nossos profissionais, sondam constantemente o nosso e outros mercados, na procura de mais produtos, inovadores, mas sempre competitivos, tudo para lhe proporcionar o melhor negócio.

É com enorme prazer que lhe apresentamos de seguida o novo catálogo LIZOTEL 2019. Este foi concebido com um novo design que permite a apresentação de todos os artigos com respectivas características que os definem.

Poderá encontrar este catálogo e respectivas actualizações em suporte digital em www.lizotel.pt

Lizotel has been implemented for 17 years as a brand in the restaurant, hotel and catering sector. We are most proud to trade on high quality products, always taking into account the satisfaction of our customers. Keeping that in mind, we offer a variety of products, as well as rapid logistics, in order to make your business our priority.

Lizotel products are designed to serve the best professionals in this highly competitive sector. The degree of innovation inherent in the Lizotel culture compels us to possess the highest quality products, always ensuring their durability, versatility, maintenance and ergonomics. Our professionals are constantly seeking the market in search of products that may be innovative but at the same time competitive, always aiming to provide the best possible deal.

It is a great pleasure for us to present the new LIZOTEL 2019 catalogue. It has been conceived using a new design that allows the presentation of all items with the respective characteristics that define them.

You may find this catalogue and its respective updates in digital support in www.lizotel.pt.

Lizotel es una marca que lleva 17 años implementada en el sector de la restauración, hostelería y catering. Nos enorgullece comercializar productos de gran calidad, siempre teniendo en cuenta la satisfacción de nuestros clientes. Para ello, ofrecemos una gran diversidad de productos, además de una rápida logística, ya que hacemos de vuestro negocio nuestra prioridad.

Los productos Lizotel están pensados para servir de la mejor forma los profesionales de este sector tan competitivo.

El grado de innovación inherente a la cultura Lizotel nos obliga a poseer la mayor calidad de productos, garantizando su durabilidad, versatilidad, mantenimiento y ergonomía. Nuestros profesionales sondan constantemente el nuestro y los demás mercados en búsqueda de más productos, innovadores pero siempre competitivos, todo ello con el objetivo de proporcionarle el mejor negocio posible.

Es un enorme placer para nosotros presentar de enseguida el nuevo catálogo LIZOTEL 2019. Este ha sido concebido recurriendo a un nuevo diseño que permite la presentación de todos los artículos con sus respectivas características que las definen.

Podrá encontrar este catálogo y sus respectivas actualizaciones en soporte digital en www.lizotel.pt.

Lizotel est une marque avec 17 ans d'expérience dans le secteur de la restauration, hôtellerie et catering. Nous sommes fiers de commercialiser des produits de grande qualité, en tenant compte de la satisfaction de nos clients.

Nous offrons ainsi une variété de produits, et une logistique rapide, en faisant de votre entreprise notre priorité.

Les produits Lizotel sont conçus pour servir au mieux les professionnels de ce secteur hautement concurrentiel. Le degré d'innovation inhérent à la culture Lizotel nous oblige à offrir la plus haute gamme de produits de qualité, afin de garantir leur durabilité, polyvalence, maintenance et ergonomie. Nos professionnels nous recherchent constamment dans notre marché ou bien dans d'autres, des produits innovants plus toujours compétitifs, dans le but de vous fournir la meilleure proposition.

C'est un grand plaisir pour nous de vous présenter le nouveau catalogue LIZOTEL 2019. Celui-ci a été conçu avec un nouveau design afin de présenter nos articles avec leurs respectives caractéristiques.

Vous pouvez retrouver ce catalogue avec les mises à jour en format digital sur notre site: www.lizotel.pt.



Símbolos

symbols símbolos symboles



MATERIAIS

materials materiales matériels

| | |
|--|---|
| INOX inox stainless steel inoxidable inoxidable | AL aluminio aluminum aluminio aluminium |
| METAL metal metal métal | ACO STEEL aço steel acero acier |
| PORCELANA porcelain porcelain porcelana porcelaine | MELAMINA melamina melamine melamina mélamine |
| ACRÍLICO acrylic acrilico acrylique | FIBRA fibra fiber fibra fibre |
| VIDRO glass vidrio verre | PE polietileno polyethylene polietileno polyéthylène |
| LDPE - | PC poli-carbonato polycarbonate poli-carbonato polycarbonate |
| PP polipropileno polypropylen polipropileno polypropylène | PS poliestireno polystyrene poliestireno polystyrène |
| EPS poliestireno expandido expanded polystyrene poliestireno expandido polystyrène expansé | TPE elastómero elastomer elastómero élastomère |
| PET polietileno tereftalato polyethylene terephthalate polietileno tereftalato polyéthylène téréphthalate | PVC - |
| poliéster polyester poliéster polyester | ABS - |
| NYLON - | ABS SAN - |
| ARDÓSIA ardósia slate pizarra ardoise | BORRACHA borracha rubber goma caoutchouc |
| Si silicone silicone silicona silicone | PEDRA pedra vulcânica volcanic stone pedra vulcânica pierre volcanique |
| algodão cotton algodón coton | PEDRA mármore marble mármol marbre |
| RESINA resin resina résine | PLÁSTICO plástico plastic plástico plastique |
| VINIL vinil vinyl vinyle | papel paper papier papier |
| BAMBU bambu bamboo bambú bambou | LÁTEX látex latex látex latex |
| COBRE cobre copper cobre cuivre | MADERA madeira wood madera bois |
| WENGUÉ wengué wengue wengué wengé | FERRO iron hierro FER |

CARACTERÍSTICAS

characteristics caractère caractère

| | |
|--|--|
| gás gas gas gaz | eléctrico electric eléctrico électrique |
| vidro vitro vitro vitro | indução induction inducción induction |
| fundido cast fundido fendu | 0,8~1,2mm |
| 4mm Protector 430/0,8mm | - |
| bisfenol A bisphenol A bisfenol A bisphénol A | |
| vidro temperado tempered glass vidrio templado verre trempé | |
| dupla camada double coating camada doble double revêtement | |
| espessura do fundo thickness of the bottom espesor de la parte inferior épaisseur du fond | |
| espessura do corpo thickness of the body espesor del corpo épaisseur du corps | |
| em conformidade alimentar in accordance food en conformidad alimentar dans conformité alimentaire | |

INFORMAÇÃO

information información information

| |
|---|
| lamparina lamp lámpara lampe |
| (**)eléctrico electric eléctrico électrique |
| lavar à mão hand wash lavado a mano lavage des mains |
| manual manual manuel |
| talheres cutlery cubiertos couverts |
| pratos plates platos assiettes |
| copos glasses tazas verres |
| tabuleiros tray fiente plateau |
| mulher woman mujer femme |
| homem man hombre homme |
| inflamável flammable inflamable inflammable |
| tóxico toxic tóxico toxique |

antiaderente
Non-stick
antiaderente
antiadhésif

selo qualidade
quality stamp
sello de calidad
label de qualité



(**) máquinas machines máquinas machines

ÍNDICE GERAL

general index índice general index général



cozinha/pastelaria

kitchen/bakeware cocina/reposteria
cuisine/pâtisserie
06<97



mesa

table mesa table
98<187



buffet

buffet buffet buffet
188<255



bar

bar pub bar
256<281



descartáveis

disposable desechable jetable
282<289



equipamentos

equipments equipamientos équipements
290<321



fardas

uniforms uniformes uniformes
322<327



limpeza

cleaning limpieza nettoyage
328<348



índice alfabético

alphabetical index indice
alfabético index alphabétique
349<357







cozinha *kitchen* cocina *cuisine*





Cozinha e Pastelaria

kitchen and bakeware cocina y reposteria cuisine et patisserie

- 09  **CAÇAROLAS/PANELAS**
cassarole/stock pot cacerola/olla faitout/marmite traiteur

- 19  **PANELAS PRESSÃO**
pressure cookers ollas a pression cocottes à pression

- 23  **ALUMÍNIO/FERRO FUNDIDO**
cast steel/iron aluminio/hierro fundido aluminium/fonte

- 28  **FRIGIDEIRAS/ GRELHADORES**
fry pans/grills sartenes/parillas poêles/grils

- 32  **TABULEIROS/ACESSÓRIOS**
roaster/accessories rustideras/accesorios plateau à rotir/accessoires

- 37  **ACESSÓRIOS P/PIZZA**
pizza accessories accesoriospizza accessoires pizza

- 38  **UTENSÍLIOS COZINHA**
kitchen utensils utensilios cocina ustensiles cuisine

- 53  **UTENSÍLIOS PREPARAÇÃO**
preparation utensils utensilios preparacion ustensiles préparation

- 65  **UTENSÍLIOS CORTE**
cutting utensils utensilios corte ustensiles coupe

- 79  **UTENSÍLIOS PASTELARIA**
pastry utensils utensilios pasteleria ustensiles pâtisserie





CAÇAROLAS/PANELAS

cassarole/stock pot cacerola/olla *faitout/marmite traiteur*

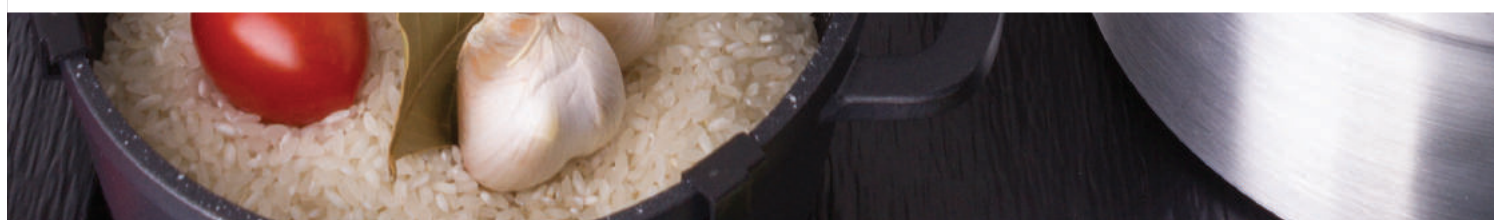



i informação information información information

espesura do fondo
thickness of the bottom
espesor de la parte inferior
épaisseur du fond

espesura do corpo
thickness of body
espesor del cuerpo
épaisseur du corps

LINHA PROFISSIONAL EM INOX

professional line stainless
línea profesional de inox
ligne professionnelle en inox

1 | INOX 21CT/0.8~1.2mm

Uma nova geração de aço inoxidável, livre de níquel e molibdênio, com alto nível de cromo, o que torna este aço bastante resistente à corrosão.

A new generation of stainless steel, and nickel-free molybdenum with high levels of chromium, which makes this quite corrosion resistant steel.

Una nueva generación de acero inoxidable, y molibdeno níquel con altos niveles de cromo, lo que hace que este acero resistente a la corrosión.

Une nouvelle génération d'acier inoxydable, et molybdène sans nickel avec des niveaux élevés de chrome, ce qui rend cet acier très résistant à la corrosion.

2 | ALUMÍNIO/4mm

aluminum aluminio aluminium

3 | INOX #430/0.8mm



CAÇAROLA BAIXA C/TAMPA

cassarole with lid cacerola con tapa faitout avec couvercle

| REF | (cm) | | | LT | |
|-------------|----------|-----|-----------|-----|--------|
| 04306600162 | Ø16x7.5 | 4mm | 0.8~1.2mm | 1.5 | 01/004 |
| 04306600182 | Ø18x10.5 | 4mm | 0.8~1.2mm | 2.5 | 01/012 |
| 04306600203 | Ø20x10.5 | 4mm | 0.8~1.2mm | 3.5 | 01/006 |
| 04306600241 | Ø24x11.5 | 4mm | 0.8~1.2mm | 4.5 | 01/006 |
| 04306600281 | Ø28x13 | 4mm | 0.8~1.2mm | 7 | 01/006 |
| 04306600361 | Ø36x14 | 4mm | 0.8~1.2mm | 14 | 01/002 |
| 04306600402 | Ø40x15 | 4mm | 0.8~1.2mm | 19 | 01/002 |
| 04306600451 | Ø45x15 | 4mm | 0.8~1.2mm | 25 | 01/002 |
| 04306600501 | Ø50x20 | 4mm | 0.8~1.2mm | 40 | 01/002 |
| 04306600551 | Ø55x22 | 4mm | 0.8~1.2mm | 52 | 01/001 |



CAÇAROLA ALTA C/TAMPA

cassarole with lid cacerola con tapa faitout avec couvercle

| REF | (cm) | | | LT | |
|-------------|----------|-----|-----------|-----|--------|
| 04306600261 | Ø26x17.5 | 4mm | 0.8~1.2mm | 9.3 | 01/002 |
| 04306600283 | Ø28x15.5 | 4mm | 0.8~1.2mm | 9.5 | 01/002 |
| 04306600322 | Ø32x16 | 4mm | 0.8~1.2mm | 13 | 01/006 |
| 04306600363 | Ø36x22 | 4mm | 0.8~1.2mm | 22 | 01/002 |
| 04306600404 | Ø40x25 | 4mm | 0.8~1.2mm | 31 | 01/002 |
| 04306600452 | Ø45x28 | 4mm | 0.8~1.2mm | 45 | 01/002 |
| 04306600502 | Ø50x32 | 4mm | 0.8~1.2mm | 57 | 01/002 |
| 0430660055 | Ø55x35 | 4mm | 0.8~1.2mm | 75 | 01/002 |
| 0430660060 | Ø60x37 | 4mm | 0.8~1.2mm | 100 | 01/002 |



PANELA C/TAMPA

stock pot with lid olla con tapa marmite traiteur avec couvercle

| REF | (cm) | | | LT | |
|-------------|--------|-----|-----------|-----|--------|
| 04306600163 | Ø16x16 | 4mm | 0.8~1.2mm | 3 | 01/004 |
| 0430660018 | Ø18x18 | 4mm | 0.8~1.2mm | 4.5 | 01/004 |
| 04306600202 | Ø20x20 | 4mm | 0.8~1.2mm | 6 | 01/004 |
| 0430660022 | Ø22x22 | 4mm | 0.8~1.2mm | 8 | 01/004 |
| 04306600242 | Ø24x24 | 4mm | 0.8~1.2mm | 11 | 01/004 |
| 0430660026 | Ø26x26 | 4mm | 0.8~1.2mm | 14 | 01/004 |
| 0433452626 | Ø26x26 | 4mm | 0.8~1.2mm | 14 | 01/004 |
| 04306600282 | Ø28x28 | 4mm | 0.8~1.2mm | 17 | 01/004 |
| 04306600321 | Ø32x32 | 4mm | 0.8~1.2mm | 25 | 01/002 |
| 04306600362 | Ø36x36 | 4mm | 0.8~1.2mm | 36 | 01/001 |
| 04306600403 | Ø40x40 | 4mm | 0.8~1.2mm | 50 | 01/001 |
| 04306600453 | Ø45x45 | 4mm | 0.8~1.2mm | 70 | 01/001 |
| 04306600503 | Ø50x50 | 4mm | 0.8~1.2mm | 100 | 01/001 |
| 0433455050 | Ø50x50 | 4mm | 0.8~1.2mm | 100 | 01/001 |

símbolo de qualidade e rigor

symbol of quality and rigor símbolo de calidad y rigor symbole de qualité et de rigueur



TAMPA
lid tapa couvercle

| REF | (cm) | | | | |
|------------|------|-----|-----------|--|--------|
| 0433450016 | Ø16 | 4mm | 0.8–1.2mm | | 01/012 |
| 0433450018 | Ø18 | 4mm | 0.8–1.2mm | | 01/012 |
| 0430665020 | Ø20 | 4mm | 0.8–1.2mm | | 01/012 |
| 0433450022 | Ø22 | 4mm | 0.8–1.2mm | | 01/012 |
| 0433450024 | Ø24 | 4mm | 0.8–1.2mm | | 01/012 |
| 0433450028 | Ø28 | 4mm | 0.8–1.2mm | | 01/012 |
| 0433450030 | Ø30 | 4mm | 0.8–1.2mm | | 01/012 |
| 0433450032 | Ø32 | 4mm | 0.8–1.2mm | | 01/006 |
| 0433450036 | Ø36 | 4mm | 0.8–1.2mm | | 01/006 |
| 0430665040 | Ø40 | 4mm | 0.8–1.2mm | | 01/006 |
| 0430665045 | Ø45 | 4mm | 0.8–1.2mm | | 01/006 |
| 0430665050 | Ø50 | 4mm | 0.8–1.2mm | | 01/006 |



FRIGIDEIRA C/2 PEGAS
frypan sartén poêle

| REF | (cm) | | | | |
|------------|---------|-----|-------|--|--------|
| 0433452004 | Ø20x4.5 | 4mm | 0.8mm | | 01/012 |



WOK
wok wok wok

| REF | (cm) | | |
|------------|-------|--|--------|
| 0430680304 | Ø26x6 | | 06/012 |



FRIGIDEIRA/PAELHEIRA
frypan/paella pan sartén/paellera poêle/plat à paella

| REF | (cm) | | | | |
|-------------|----------|-----|---------|--|--------|
| 04306600301 | 1 Ø30x7 | 4mm | 1–1.2mm | | 01/006 |
| 04306600401 | 2 Ø40x8 | 4mm | 1–1.2mm | | 01/004 |



CAÇAROLETE
casserole cazo casserole

| REF | (cm) | | LT | | |
|-------------|-------------|-----|-----|--|--------|
| 0430661810 | 1 Ø18x10.5 | 4mm | 2.5 | | 01/012 |
| 04306600161 | Ø16x12 | 4mm | 2.5 | | 01/012 |
| 04306600164 | Ø16x16 | 4mm | 3 | | 01/006 |
| 04334518102 | Ø18x10.5 | 4mm | 8 | | 01/001 |
| 04306600183 | Ø18x18 | 4mm | 2.5 | | 01/004 |
| 0433451818 | Ø18x18 | 4mm | 4.5 | | 01/006 |
| 04306600207 | Ø20x14 | 4mm | 4.5 | | 01/012 |
| 04306600205 | Ø20x20 | 4mm | 4 | | 01/012 |
| 04306600165 | 2 Ø16x7.5 | 4mm | 1.5 | | 01/004 |
| 0433451675 | Ø16x7.5 | 4mm | 1.5 | | 01/004 |
| 0433451810 | Ø18x10.5 | 4mm | 2.5 | | 01/004 |
| 04306600201 | Ø20x14 | 4mm | 4 | | 01/006 |





CAÇAROLAS/PANELAS
cassarole/stock pot cacerola/olla faitout/marmite traiteur



LINHA HORECA
HORECA linea línea HORECA ligne HORECA

Nova linha de panelas e caçarolas projectadas a pensar nos profissionais de hotelaria e cozinheiros mais exigentes. Construídas em inox aço 18/10.
 New line of pots and pans designed for hotel professionals and more demanding cooks. Made of stainless steel 18/10.
 Nueva línea de ollas y cacerolas proyectadas pensando en los profesionales de hostelería y cocineros más exigentes. Construídas en acero inoxidable 18/10.
 Nouvelle ligne de marmites et casseroles conçue pour les professionnels de l'hôtellerie et les cuisiniers les plus exigeants. Fait d'acier inoxydable 18/10.



CAÇAROLA BAIXA C/TAMPA
cassarole cacerola faitout

| REF | (cm) | LT | |
|-------------|---------|-----|--------|
| 04340620012 | Ø32x7.5 | 6 | 01/001 |
| 04340660012 | Ø36x8 | 8.1 | 01/001 |
| 04340600011 | Ø40x8 | 10 | 01/001 |



PANELA C/TAMPA
stock pot olla marmite traiteur

| REF | (cm) | LT | |
|-------------|--------|----|--------|
| 04340600012 | Ø40x25 | 32 | 01/001 |



CAÇAROLA ALTA C/TAMPA
cassarole cacerola faitout

| REF | (cm) | LT | |
|-------------|----------|------|--------|
| 04340600032 | Ø20x9 | 3 | 01/001 |
| 0434064006 | Ø24x10.5 | 5 | 01/001 |
| 04340680031 | Ø28x17 | 10.5 | 01/001 |
| 04340620011 | Ø32x15 | 12.1 | 01/001 |



PANELA C/TAMPA
stock pot olla marmite traiteur

| REF | (cm) | LT | |
|-------------|--------|------|--------|
| 0434066002 | Ø16x16 | 3 | 01/001 |
| 0434060001 | Ø20x20 | 6.3 | 01/001 |
| 0434064003 | Ø24x24 | 10.5 | 01/001 |
| 04340680021 | Ø28x28 | 17.2 | 01/001 |
| 0434062001 | Ø32x30 | 26 | 01/001 |



CAÇAROLA ALTA C/TAMPA
casseroles cacerola faitout

| REF | (cm) | LT | |
|-------------|--------|------|--------|
| 04340660011 | Ø36x22 | 22.4 | 01/001 |



PANELA C/TAMPA
stock pot olla marmite traiteur

| REF | (cm) | LT | |
|-------------|--------|------|--------|
| 0434066001 | Ø36x36 | 36.6 | 01/001 |
| 04340600031 | Ø40x40 | 50 | 01/001 |



PANELA C/TAMPA
stock pot with lid olla con tapamarmite traiteur avec couvercle

| REF | (cm) | LT | |
|-------------|--------|-----|--------|
| 04338913601 | Ø60x40 | 113 | 02/001 |
| 0433891360 | Ø60x60 | 170 | 01/001 |



PANELA C/TAMPA C/CESTO
stock pot with lid basquet olla con tapa con cesta marmite traiteur avec couvercle avec panier

| REF | (cm) | LT | |
|------------|--------|------|--------|
| 0430669301 | Ø30x29 | 20.5 | 01/004 |



PANELA C/CESTO E ESCORREDOR
cooker with basquet olla con cestillo marmite with panier

| REF | (cm) | LT | |
|------------|------|----|--------|
| 0434064001 | - | - | 01/004 |

panela cooker olla marmite Ø25.7x24.5
cesto basquet cestillo panier Ø25.8x19.5
escorredor colander escurridera passoire Ø25.8x7.5



FRIGIDEIRA
frypan sartien poêle

| REF | (cm) | LT | |
|-------------|------|---------|-------------|
| 0434062003 | 1 | Ø32x10 | 6 01/001 |
| 04340600021 | | Ø40x10 | 10.1 01/001 |
| 0434060014 | 2 | Ø20x7.5 | 1.6 01/001 |
| 04340680091 | | Ø28x8.5 | 3.7 01/001 |



CAÇAROLETE
casseroles cazo casserole

| REF | (cm) | LT | |
|-------------|------|----------|------------|
| 0434066008 | 1 | Ø16x8 | 1.4 01/001 |
| 0434068005 | | Ø18x9 | 2 01/001 |
| 0433890251 | 2 | Ø18x9.5 | 2.2 01/048 |
| 04338902511 | | Ø20x10.3 | 3.1 01/048 |

sem indução
without induction
sin inducción
sans induction



CAÇAROLAS/PANELAS

cassarole/stock pot cacerola/olla faitout/marmite traiteur



ANETT



CAÇAROLA BAIXA C/TAMPA
cassarole with lid cacerola con tapa faitout avec couvercle

| REF | (cm) | LT | |
|------------|--------|-----|--------|
| 0434066024 | Ø16x10 | 2 | 01/004 |
| 0434068033 | Ø18x10 | 2.4 | 01/004 |
| 0434060029 | Ø20x10 | 3 | 01/004 |
| 0434062030 | Ø22x12 | 4.5 | 01/004 |
| 0434064028 | Ø24x14 | 6.5 | 01/004 |
| 0434066028 | Ø26x16 | 8.5 | 01/004 |
| 0434068002 | Ø28x12 | 7.4 | 01/004 |
| 0434060003 | Ø30x14 | 10 | 01/004 |



CAÇAROLA ALTA C/TAMPA
cassarole with lid cacerola con tapa faitout avec couvercle

| REF | (cm) | LT | |
|------------|--------|------|--------|
| 0434066025 | Ø16x12 | 2.5 | 01/004 |
| 0434068009 | Ø18x14 | 3.5 | 01/004 |
| 0434060004 | Ø20x15 | 4.7 | 01/004 |
| 0434062002 | Ø22x18 | 7 | 01/004 |
| 0434064004 | Ø24x19 | 8.5 | 01/004 |
| 0434066006 | Ø26x20 | 10 | 01/004 |
| 0434068003 | Ø28x24 | 14.8 | 01/002 |
| 0434060002 | Ø30x28 | 20 | 01/002 |



FRIGIDEIRA
frypan sartén poêle

| REF | (cm) | |
|------------|---------|--------|
| 0434064020 | Ø24x6.5 | 01/006 |





LINHA PROFISSIONAL EM ALUMÍNIO

professional linea aluminum
línea profesional aluminum
ligne professionnelle aluminum

Panela e caçarolas projectadas para os profissionais de hotelaria e cozinheiros mais exigentes. Constituídas por alumínio puro para melhor distribuição de calor e evitar que os alimentos peguem no fundo da panela. Alças são ergonómicas e térmicas que estão ligados à panela com rebites.

Pots and pans designed for hospitality professionals and discerning cooks. Consisting of pure aluminum for better heat distribution and prevent the food getting in the pan. Handles are ergonomic and thermals that are attached to the pan with rivets.

Ollas y sartenes diseñados para profesionales de la hostelería y los cocineros más exigentes. Consta de aluminio puro para una mejor distribución del calor y evitar que la comida para conseguir en la sartén. Los mangos son ergonómicos y térmicos que se adjuntan a la sartén con remaches.

Casserolles et poêles conçues pour les professionnels de l'hôtellerie et les cuisiniers les plus exigeants. Elles sont composées d'aluminium pur pour une meilleure répartition de chaleur et éviter la nourriture obtenir dans la casserole. Les poignées sont ergonomiques et thermiques qui sont attachés à la poêle avec des rivets.



CAÇAROLA BAIXA C/TAMPA

casserole with lid cacerola con tapa faitout avec couvercle

| REF | (cm) | | | LT | |
|-------------|------------|-----|-----|------|--------|
| 04326700031 | Ø19x8.5 | 5mm | 4mm | 2.5 | 01/001 |
| 04326700051 | Ø22x9.5 | 5mm | 4mm | 3.5 | 01/001 |
| 0432670006 | Ø24x11 | 5mm | 4mm | 5 | 01/001 |
| 04326700081 | Ø26x12 | 5mm | 4mm | 6.5 | 01/001 |
| 04326700101 | Ø28x12.5 | 5mm | 4mm | 8 | 01/001 |
| 0432670012 | Ø30.5x13.5 | 5mm | 4mm | 10 | 01/001 |
| 0432670016 | Ø32x15.5 | 5mm | 4mm | 12.5 | 01/001 |



CAÇAROLA ALTA C/TAMPA

casserole with lid cacerola con tapa faitout avec couvercle

| REF | (cm) | | | LT | |
|------------|------------|-----|-----|----|--------|
| 0432670003 | Ø19x12.5 | 5mm | 4mm | 3 | 01/001 |
| 0432670005 | Ø23x14 | 5mm | 4mm | 5 | 01/001 |
| 0432670008 | Ø27x15.5 | 5mm | 4mm | 8 | 01/001 |
| 0432670010 | Ø29x17 | 5mm | 4mm | 10 | 01/001 |
| 0432670015 | Ø33x20 | 5mm | 4mm | 15 | 01/001 |
| 0432670020 | Ø37x22 | 5mm | 4mm | 20 | 01/001 |
| 0432670030 | Ø42.5x23 | 5mm | 4mm | 30 | 01/001 |
| 0432670040 | Ø44.5x27.5 | 5mm | 4mm | 40 | 01/001 |
| 0432670060 | Ø51x32 | 5mm | 4mm | 60 | 01/001 |



PANELA C/TAMPA

stock pot with lid olla con tapamarmite traiteur avec couvercle

| REF | (cm) | | | LT | |
|------------|------------|-----|-----|------|--------|
| 0432671020 | Ø22x17.5 | 5mm | 4mm | 6.5 | 01/001 |
| 0432671010 | Ø25.5x21 | 5mm | 4mm | 10 | 01/001 |
| 0432671015 | Ø29x25.5 | 5mm | 4mm | 15 | 01/001 |
| 0432671030 | Ø30.5x23 | 5mm | 4mm | 17 | 01/001 |
| 0432671023 | Ø34x29 | 5mm | 4mm | 23 | 01/001 |
| 0432671035 | Ø36x23.5 | 5mm | 4mm | 23.5 | 01/001 |
| 0432671040 | Ø41.5x30.5 | 5mm | 4mm | 41 | 01/001 |
| 0432671055 | Ø55x37 | 5mm | 4mm | 88 | 01/001 |

**CAÇAROLAS/PANELAS**

cassarole/stock pot cacerola/olla faitout/marmite traiteur

**LINHA PROFISSIONAL EM ALUMÍNIO PURO FUNDIDO E POLIDO**

professional linea aluminum
línea profesional aluminum
ligne professionnelle aluminum

Alumínio puro fundido e polido (não reciclado).

Linha de produtos produzidos em alumínio fundido de elevada espessura.

A espessura do fundo é no mínimo de 8mm, pensado para permitir uma melhor e mais uniforme distribuição do calor, torna a cozedura mais rápida, proporciona uma elevada durabilidade e resistência a altas temperaturas.

Cast and polished pure aluminum (not recycled).

Product line produced in cast aluminum high thickness.

The thickness of the bottom is at least 8mm, designed to allow a better and more uniform heat distribution becomes faster cooking, provides a high durability and resistance to high temperatures.

Alumínio puro fundido y pulido (no reciclado).

Línea de productos producidos en el molde de aluminio de gran espesor.

El espesor de la parte inferior es al menos de 8 mm, diseñado para permitir una distribución de calor mejor y más uniforme se convierte en una cocción más rápida, proporciona una alta durabilidad y resistencia a las altas temperaturas.

Aluminium pur fondu et poli (non recyclé).

Une ligne de produit fabriquée en fonte avec une grande épaisseur d'aluminium.

L'épaisseur du fond d'un minimum de 8 mm est destinée à permettre une meilleure distribution de chaleur plus uniforme et permet une cuisson plus rapide, offre une grande durabilité et une résistance aux températures élevées.



ÇAÇAROLA ALTA C/TAMPA
casserole with lid cacerola con tapa faitout avec couvercle

| REF | (cm) | | LT | |
|------------|----------|------|------|--------|
| 0438661020 | Ø20x9.5 | >8mm | 3 | 01/001 |
| 0438661022 | Ø22x10.5 | >8mm | 4 | 01/001 |
| 0438661024 | Ø24x11 | >8mm | 5 | 01/001 |
| 0438661026 | Ø26x11 | >8mm | 6 | 01/001 |
| 0438661030 | Ø30x13 | >8mm | 8.5 | 01/001 |
| 0438661032 | Ø32x15.5 | >8mm | 11.5 | 01/001 |
| 0438661034 | Ø34x16.5 | >8mm | 14.5 | 01/001 |
| 0438661036 | Ø36x19 | >8mm | 17 | 01/001 |
| 0438661038 | Ø38x19 | >8mm | 20 | 01/001 |
| 0438661040 | Ø40x20 | >8mm | 25 | 01/001 |
| 0438661042 | Ø42x21 | >8mm | 30 | 01/001 |
| 0438661044 | Ø44x22 | >8mm | 35 | 01/001 |
| 0438661046 | Ø46x22.5 | >8mm | 40 | 01/001 |



PANELA C/TAMPA
stock pot with lid olla con tapa marmite traiteur avec couvercle

| REF | (cm) | | LT | |
|------------|----------|------|------|--------|
| 0438662018 | Ø18x13.5 | >8mm | 3.5 | 01/001 |
| 0438662022 | Ø22x17.5 | >8mm | 6.5 | 01/001 |
| 0438662026 | Ø26x20.5 | >8mm | 10.5 | 01/001 |
| 0438662028 | Ø28x22.5 | >8mm | 13 | 01/001 |
| 0438662030 | Ø30x24.5 | >8mm | 16.5 | 01/001 |
| 0438662032 | Ø32x26.5 | >8mm | 21 | 01/001 |
| 0438662034 | Ø34x27.5 | >8mm | 25 | 01/001 |
| 0438662036 | Ø36x28.5 | >8mm | 30 | 01/001 |
| 0438662040 | Ø40x31.5 | >8mm | 40 | 01/001 |
| 0438662044 | Ø44x37 | >8mm | 50 | 01/001 |



SERTĂ
fryan sartén marmite pflanne

| REF | (cm) | | LT | |
|------------|---------|------|----|--------|
| 0438663026 | Ø26x4.5 | >8mm | 1 | 01/001 |
| 0438663028 | Ø28x5 | >8mm | | 01/001 |
| 0438663030 | Ø30x5.5 | >8mm | | 01/001 |
| 0438663032 | Ø32x5.8 | >8mm | | 01/001 |



SERTĂ
fryan sartén marmite pflanne

| REF | (cm) | | LT | |
|------------|---------|------|----|--------|
| 0438663034 | Ø34x6 | >8mm | | 01/001 |
| 0438663036 | Ø36x6.5 | >8mm | | 01/001 |
| 0438663038 | Ø38x6.5 | >8mm | | 01/001 |
| 0438663040 | Ø40x7 | >8mm | | 01/001 |



CAFETEIRA
coffee pot cafetera cafetière

| REF | (cm) | | LT | |
|------------|------------|-----|-----|--------|
| 0438663006 | Ø16.5x22.5 | 5mm | 2.5 | 01/001 |
| 0438663009 | Ø21x25.5 | 5mm | 5 | 01/001 |

aluminio polido polished aluminium
aluminio polido aluminium poli



CAÇAROLAS/PANELAS

cassarole/stock pot cacerola/olla faitout/marmite traiteur



CAÇAROLA C/TAMPA VIDRO
cassarole with lid cacerola con tapa faitout avec couvercle

| REF | (cm) | | |
|------------|--------|-----|--------|
| 0433430030 | Ø30x10 | 3mm | 01/006 |



WOK C/TAMPA VIDRO
wok with lid wok con tapa wok avec couvercle

| REF | (cm) | | |
|------------|-------|-----|--------|
| 0433430028 | Ø28x8 | 3mm | 01/006 |

economia e eficácia na cozinha

economy and efficiency in the kitchen economía y eficacia en la cocina économie et efficacité dans la cuisine



NOVO
new

Adaptador placa indução

induction adapter
adaptador induccion
adapteur induction

Permite que panelas e caçarolas tradicionais possam ser utilizados em placas de indução.

Allows traditional pots and pans to be used on induction hobs.

Permite que las ollas y cacerolas tradicionales puedan ser utilizadas en placas de inducción.

Permet d'utiliser des pots et des casseroles traditionnels sur des plaques à induction.



ADAPTADOR PLACA INDUÇÃO
induction adapter adaptador induccion adapteur induction

| REF | (cm) | |
|------------|------|--------|
| 0433900002 | Ø24 | 01/006 |



TAMPA AJUSTÁVEL
adjustable lid tapa ajustable couvercle ajustable

| REF | (cm) | |
|------------|------|--------|
| 0433657330 | Ø30 | 01/040 |

ajustável adjustable ajustable ajustable - 22/24/26/28cm



PANELAS DE PRESSÃO

pressure cookers ollas a pression cocottes à pression

**PANELAS DE PRESSÃO**

pressure cookers ollas a presión cocottes à pression

**NOVO**
new**PANELA DE PRESSÃO**

pressure cookers olla a presión cocotte à pression

| REF | MODELO | (cm) | LT | |
|------------|-----------|--------|----|--------|
| 0433185009 | EV2425009 | Ø28x30 | 12 | 01/001 |
| 0433185010 | EV2425010 | Ø28x38 | 16 | 01/001 |

Corpo de 1 mm de espessura
Tampa de 1,2 mm de espessura
Sistema de fecho progressivo
3 sistemas de segurança independentes
Válvula rotativa de sinalização

1 mm thick body
1.2 mm thick cover
Progressive locking system
3 independent security systems
Rotary signaling valve

Cuerpo de 1 mm de espesor
Cubierta de 1,2 mm de espesor
Sistema de cierre progresivo
3 sistemas de seguridad independientes
Válvula rotativa de señalización

Corps de 1 mm d'épaisseur
Couverture de 1,2 mm d'épaisseur
Système de verrouillage progressif
3 systèmes de sécurité indépendants
Vanne de signalisation rotative

**PANELA DE PRESSÃO**

pressure cookers olla a presión cocotte à pression

| REF | MODELO | (cm) | LT | |
|------------|---------|--------|----|--------|
| 0432280007 | C24-7L | Ø24x26 | 7 | 01/006 |
| 0432280009 | C26-9L | Ø26x29 | 9 | 01/006 |
| 0432280018 | C32-18L | Ø32x35 | 18 | 01/004 |
| 0432280024 | C32-24L | Ø32x42 | 24 | 01/004 |



contém: 2 asas, 1 válvula rotativa de saída de vapor, 1 válvula de segurança
venda de acessórios em separado: borracha, botão de aperto, asa e válvula rotativa

contains: 2 handles, 1 rotary valve steam output, 1 safety valve
separately selling accessories: rubber, clamping knob, handle and rotary valve

contiene: 2 asas, 1 válvula rotativa de salida de vapor, 1 válvula de seguridad
venta de accesorios por separado: goma, botón de apriete, asa y válvula rotativa

contient: 2 poignées, 1 valve rotative de débit de vapeur, 1 valve de sécurité
vente d'accessoires séparément: caoutchouc, bouton serrage, poignée et valve rotative



| MODELO model modelo modèle | ESPESSURA CORPO E FUNDO (mm) wall thickness and background espesor de pared y antecedentes épaisseur de paroi et fond | ESPESSURA TAMPA (mm) thickness of lid espesor de tapa épaisseur de couvercle | PRESSÃO (kpa) pressure presión pression | PRESSÃO SEGURANÇA 1 (kpa) pressure safety seguridad presión sécurité de pression | PRESSÃO SEGURANÇA 2 (kpa) pressure safety seguridad presión sécurité de pression |
|-------------------------------------|--|---|--|---|---|
| C24-7L | 2.2 | 2.5 | 75 | 90-140 | 140-180 |
| C26-9L | 3 | 3.5 | 70 | 90-120 | 120-140 |
| C28-11L | 3 | 3.5 | 50 | 80-100 | 110-130 |
| C32-18L | 3.5 | 3.5 | 50 | 80-100 | 110-130 |
| C32-24L | 4 | 3.5 | 50 | 80-100 | 110-130 |

ACESSÓRIOS
accessories
accessorios
accessoires

| MODELO model modelo modèle | VÁLVULA valve válvula valve | BORRACHA rubber goma caoutchouc | BOTÃO DE APERTO tightening button botón de apriete bouton serrage | ASA handle asa poignée | VÁLVULA DE SEGURANÇA valve safety válvula de seguridad valve de sécurité |
|-------------------------------------|--------------------------------------|--|--|---------------------------------|---|
| C24-7L | 04322800074 | 04322800071 | 04322800072 | 04322800073 | 0432280001 |
| C26-9L | 04322800074 | 04322800091 | 04322800092 | 04322800093 | 0432280001 |
| C28-11L | 04322800094 | 04322800111 | 04322800092 | 04322800093 | 0432280001 |
| C32-18L | 04322800094 | 04322800241 | 04322800362 | 04322800093 | 0432280001 |
| C32-24L | 04322800094 | 04322800241 | 04322800362 | 04322800093 | 0432280001 |



PANELA DE PRESSÃO

pressure cookers olla a presión cocotte à pression

| REF | MODELO | (cm) | LT | |
|------------|---------|--------|----|--------|
| 0432280036 | C36-36L | Ø36x48 | 36 | 01/002 |

contém: 2 asas, 2 válvulas rotativa de saída de vapor, 2 válvulas de segurança
venda de acessórios em separado: borracha, botão de aperto, asa e válvula rotativa

contains: 2 handles, 2 rotary valve steam output, 2 safety valve
separately selling accessories: rubber, clamping knob, handle and rotary valve

contiene: 2 asas, 2 válvulas rotativa de salida de vapor, 2 válvulas de seguridad
venta de accesorios por separado: goma, botón de apriete, asa y válvula rotativa

contient: 2 poignées, 2 valves rotative de débit de vapeur, 2 valves de sécurité
vente d'accessoires séparément: caoutchouc, bouton serrage, poignée et valve rotative



| MODELO model modelo modèle | ESPESSURA CORPO E FUNDO (mm) wall thickness and background espesor de pared y antecedentes épaisseur de paroi et fond | ESPESSURA TAMPA (mm) thickness of lid espesor de tapa épaisseur de couvercle | PRESSÃO (kpa) pressure presión pression | PRESSÃO SEGURANÇA 1 (kpa) pressure safety seguridad presión sécurité de pression | PRESSÃO SEGURANÇA 2 (kpa) pressure safety seguridad presión sécurité de pression |
|-------------------------------------|--|---|--|---|---|
| C36-36L | 3.2 | 3.2 | 75 | 70-100 | 100-130 |



PANELA DE PRESSÃO

pressure cookers olla a presión cocotte à pression

| REF | MODELO | (cm) | LT | |
|------------|---------|--------|----|--------|
| 0432280045 | C44-45L | Ø44x44 | 45 | 01/002 |
| 0432280075 | C50-75L | Ø50x52 | 75 | 01/001 |

contém: 4 asas (2 panela + 2 tampa), 2 válvula rotativa de saída de vapor, 2 válvula de segurança
venda de acessórios em separado: borracha, botão de aperto, asa e válvula rotativa

contains: 4 handles (2 cooker + 2 lid), 2 rotary valve steam output, 2 safety valve
separately selling accessories: rubber, clamping knob, handle and rotary valve

contiene: 4 asas (2 olla + 2 tapa), 2 válvula rotativa de salida de vapor, 2 válvula de seguridad
venta de accesorios por separado: goma, botón de apriete, asa y válvula rotativa

contient: 4 poignées (2 cocotte + 2 couvercle), 2 valve rotative de débit de vapeur, 2 valve de sécurité
vente d'accessoires séparément: caoutchouc, bouton serrage, poignée et valve rotative



| MODELO model modelo modèle | ESPESSURA CORPO E FUNDO (mm) wall thickness and background espesor de pared y antecedentes épaisseur de paroi et fond | ESPESSURA TAMPA (mm) thickness of lid espesor de tapa épaisseur de couvercle | PRESSÃO (kpa) pressure presión pression | PRESSÃO SEGURANÇA 1 (kpa) pressure safety seguridad presión sécurité de pression | PRESSÃO SEGURANÇA 2 (kpa) pressure safety seguridad presión sécurité de pression |
|-------------------------------------|--|---|--|---|---|
| C44-45L | 3.4 | 3.4 | 50 | 70-100 | 100-130 |
| C50-75L | 3.4 | 3.4 | 50 | 70-100 | 100-130 |

ACESSÓRIOS accessories accessoires accessoires



| MODELO model modelo modèle | VÁLVULA valve válvula valve | BORRACHA rubber goma caoutchouc | BOTÃO DE APERTO tightening button botón de apriete bouton serrage | ASA handle asa poignée | VÁLVULA DE SEGURANÇA valve safety válvula de seguridad valve de sécurité |
|-------------------------------------|--------------------------------------|--|--|---------------------------------|---|
| C36-36L | 04322800094 | 04322800361 | 04322800362 | 04322800363 | 0432280001 |
| C44-45L | 04322800094 | 04322800451 | 04322800362 | 04322800453 | 0432280001 |
| C50-75L | 04322800094 | 04322800751 | 04322800362 | 04322800453 | 0432280001 |



PANELAS DE PRESSÃO

pressure cookers ollas a presión cocottes à pression



PANELA DE PRESSÃO

pressure cookers olla a presión cocotte à pression

| REF | MODELO | (cm) | LT | |
|------------|----------|--------|----|--------|
| 0432280027 | CS24-7L | Ø24x26 | 7 | 01/006 |
| 0432280026 | CS26-9L | Ø26x29 | 9 | 01/006 |
| 0432280028 | CS28 11L | Ø28x30 | 11 | 01/004 |

contém: 2 asas, 1 válvula rotativa de saída de vapor, 1 válvula de segurança
venda de acessórios em separado: borracha, botão de aperto, asa e válvula rotativa

contains: 2 handles, 1 rotary valve steam output, 1 safety valve
separately selling accessories: rubber, clamping knob, handle and rotary valve

contiene: 2 asas, 1 válvula rotativa de salida de vapor, 1 válvula de seguridad
venta de accesorios por separado: goma, botón de apriete, asa y válvula rotativa

contient: 2 poignées, 1 valve rotative de débit de vapeur, 1 valve de sécurité
vente d'accessoires séparément: caoutchouc, bouton serrage, poignée et valve rotative

| MODELO model modelo modèle | ESPESSURA CORPO E FUNDO (mm) wall thickness and background espesor de pared y antecedentes épaisseur de paroi et fond | ESPESSURA TAMPÃO (mm) thickness of lid espesor de tapa épaisseur de couvercle | PRESSÃO (kpa) pressure presión pression | PRESSÃO SEGURANÇA 1 (kpa) pressure safety seguridad presión sécurité de pression | PRESSÃO SEGURANÇA 2 (kpa) pressure safety seguridad presión sécurité de pression |
|-------------------------------------|--|--|--|---|---|
| CS24-7L | 1 | 1.5 | 70 | 90-120 | 120-140 |
| CS26-9L | 1 | 1.5 | 70 | 90-120 | 120-140 |
| CS28-11L | 1 | 1.5 | 70 | 90-120 | 120-140 |

ACESSÓRIOS accessories accessoires accessoires



| MODELO model modelo modèle | VÁLVULA valve válvula valve | BORRACHA rubber goma caoutchouc | BOTÃO DE APERTO tightening button botón de apriete bouton serrage | ASA handle asa poignée | VÁLVULA DE SEGURANÇA valve safety válvula de seguridad valve de sécurité |
|-------------------------------------|--------------------------------------|--|--|---------------------------------|---|
| CS24-7L | 04322800074 | 04322800271 | 04322800072 | 04322800073 | 04322800001 |
| CS26-9L | 04322800074 | 04322800261 | 04322800092 | 04322800093 | 04322800001 |
| CS28-11L | 04322800074 | 04322800283 | 04322800281 | 04322800093 | 04322800282 |



ALUMÍNIO/FERRO FUNDIDO

cast steel/iron alumínio/hierro fundido aluminium/fer fondu



ALUMÍNIO FUNDIDO

cast steel alumínio fundido aluminium fondu

ANTIADERENTE
WHITFORD XILAN PLUS

Permite cozinhar mais saudáveis, ao diminuir a quantidade do óleo utilizado na cozinha. Tem longa duração, maior durabilidade do revestimento e é fácil de limpar.

It allows healthier cooking, to decrease the amount of oil used in cooking.

It has long term durability of the coating and is easy to clean.

Permite cocinar más saludable, para disminuir la cantidad de aceite usado en la cocina.

Tiene una durabilidad a largo plazo del revestimiento y es fácil de limpiar.

Permet une cuisson plus saine, diminue la quantité d'huile utilisée en cuisine.

Durabilité à long terme du revêtement, facile à nettoyer.

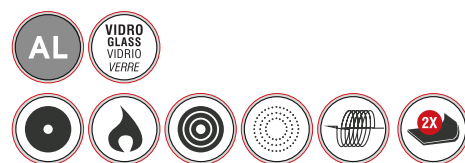

CAÇAROLA C/TAMPA EM VIDRO

casserole with glass lid
cacerola con tapa en vidrio
cocotte avec couvercle en verre

| REF | (cm) | | |
|------------|-----------|-----|--------|
| 0433440116 | 1 Ø16x7.3 | 4mm | 01/012 |
| 0433440120 | 2 Ø20x9 | 4mm | 01/008 |

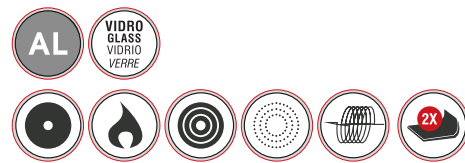

WOK C/TAMPA EM VIDRO

wok with glass lid
wok con tapa en vidrio
wok avec couvercle en verre

| REF | (cm) | | |
|------------|-------|-----|--------|
| 0433443132 | Ø32x9 | 2mm | 01/004 |

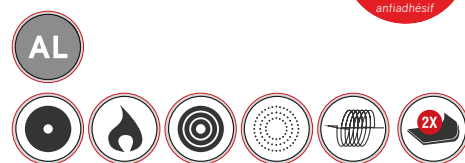
CAÇAROLA
casserole cacerola cocotte

| REF | (cm) | LT | |
|-------------|------------|-----|--------|
| 0433440616 | 1 Ø18x8 | 1.3 | 01/012 |
| 0433440620 | Ø20x9.5 | 2.2 | 01/006 |
| 0433440624 | Ø24x11.5 | - | 01/006 |
| 04334406241 | 2 Ø24x11.5 | - | 01/006 |



FERRO FUNDIDO

cast iron hierro fundido fonte



MINI CAÇAROLA

mini cassarole mini cacerola mini cocotte

| REF | | (cm) | LT | |
|-------------|---|-----------|------|--------|
| 0433695012 | 1 | Ø12.5x9.4 | 0.3 | 01/016 |
| 04336950121 | 2 | Ø12.5x9.4 | 0.3 | 01/016 |
| 0433694610 | 3 | Ø10 | 0.25 | 01/016 |
| 04336946101 | 4 | Ø10 | 0.25 | 01/016 |

INTERIOR ESMALTADO ENAMELED INTERIOR
INTERIOR ESMALTADO INTÉRIEUR EMAILLÉ



CAÇAROLA

cassarole cacerola cocotte

| REF | | (cm) | LT | |
|-------------|---|------|-----|--------|
| 0433690034 | 1 | Ø11 | 0.4 | 01/012 |
| 0433690113 | | Ø14 | 0.8 | 01/008 |
| 04336900341 | 2 | Ø11 | 0.4 | 01/012 |
| 04336901131 | 3 | Ø14 | 0.8 | 01/008 |
| 04336901141 | | Ø18 | 2 | 01/004 |
| 04336901151 | | Ø20 | 2.6 | 01/004 |
| 04336905221 | | Ø22 | 3 | 01/004 |
| 04336901161 | | Ø24 | 4.2 | 01/002 |
| 04336905281 | | Ø28 | 6.5 | 01/002 |
| 0433690114 | 4 | Ø18 | 2 | 01/004 |
| 0433690115 | | Ø20 | 2.6 | 01/004 |
| 0433690522 | | Ø22 | 3 | 01/002 |
| 0433690116 | | Ø24 | 4.2 | 01/002 |
| 0433690528 | | Ø28 | 6.5 | 01/002 |

INTERIOR ESMALTADO ENAMELED INTERIOR
INTERIOR ESMALTADO INTÉRIEUR EMAILLÉ

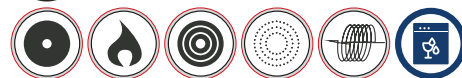

CAÇAROLA

cassarole cacerola cocotte

| REF | (cm) | LT | |
|------------|------|----|--------|
| 0433690055 | Ø32 | 8 | 01/001 |

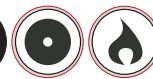

PANELA C/PÉS

stock pot olla marmite

| REF | (cm) | LT | |
|------------|-------|-----|--------|
| 0433696211 | Ø11.3 | 0.8 | 01/012 |
| 0433696220 | Ø20 | 3 | 01/001 |
| 0433690098 | Ø26 | 8 | 01/001 |
| 0433690099 | Ø29 | 12 | 01/001 |





FERRO FUNDIDO
cast iron hierro fundido fonte



FRIGIDEIRA
frypan sartén poêle

| REF | (cm) | |
|------------|---------|--------|
| 0433690014 | Ø24.5x5 | 01/006 |

INTERIOR ESMALTADO ENAMELED INTERIOR
INTERIOR ESMALTADO INTÉRIEUR ÉMAILLÉ



ASSADEIRA OVAL
oval broiler parrilla oval gril ovale

| REF | (cm) | |
|------------|-----------|--------|
| 0433691029 | 29x20.5x5 | 01/006 |

INTERIOR ESMALTADO ENAMELED INTERIOR
INTERIOR ESMALTADO INTÉRIEUR ÉMAILLÉ



FRIGIDEIRA MINI
frypan sartén poêle

| REF | (cm) | |
|------------|---------------|--------|
| 0433690058 | 12.8x10.5x2.5 | 01/024 |

INTERIOR ESMALTADO ENAMELED INTERIOR
INTERIOR ESMALTADO INTÉRIEUR ÉMAILLÉ

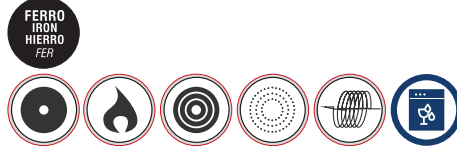

CAÇAROLETE
casserole cacerolita casserole

| REF | (cm) | |
|------------|-------|--------|
| 0433690078 | Ø10x4 | 01/024 |

INTERIOR ESMALTADO ENAMELED INTERIOR
INTERIOR ESMALTADO INTÉRIEUR ÉMAILLÉ

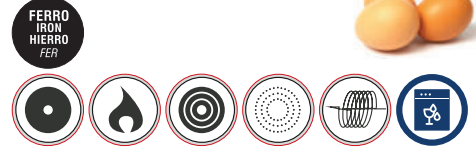

FRIGIDEIRA MINI
frypan sartén poêle

| REF | (cm) | |
|------------|-------|--------|
| 0433690044 | Ø16x3 | 01/016 |

INTERIOR ESMALTADO ENAMELED INTERIOR
INTERIOR ESMALTADO INTÉRIEUR ÉMAILLÉ



FRIGIDEIRA MINI
frypan sartén poêle

| REF | (cm) | |
|------------|-------|--------|
| 0433690059 | Ø16x3 | 01/012 |

INTERIOR ESMALTADO ENAMELED INTERIOR
INTERIOR ESMALTADO INTÉRIEUR ÉMAILLÉ



FRIGIDEIRA MINI
frypan sartén poêle

| REF | (cm) | |
|------------|-------|--------|
| 0433690046 | Ø13x2 | 01/024 |

INTERIOR ESMALTADO ENAMELED INTERIOR
INTERIOR ESMALTADO INTÉRIEUR ÉMAILLÉ



MINI FRIGIDEIRA
frypan sartén poêle

| REF | (cm) | |
|------------|-------|--------|
| 0433690914 | Ø14.5 | 01/024 |
| 0433690916 | Ø16 | 01/016 |

INTERIOR ESMALTADO ENAMELED INTERIOR
INTERIOR ESMALTADO INTÉRIEUR ÉMAILLÉ



FRIGIDEIRA «BITOQUE»
frypan sartén poêle

| REF | (cm) | |
|------------|---------|--------|
| 0733610010 | Ø19.5x3 | 01/012 |

INTERIOR ESMALTADO ENAMELED INTERIOR
INTERIOR ESMALTADO INTÉRIEUR ÉMAILLÉ



SALADEIRA
salad bowl ensaladera saladier

| REF | (cm) | |
|-------------|---------|--------|
| 0433690043 | 8x8x4.7 | 01/036 |
| 04336900431 | 10x10x6 | 01/024 |

INTERIOR ESMALTADO ENAMELED INTERIOR
INTERIOR ESMALTADO INTÉRIEUR ÉMAILLÉ



TRAVESSA
platter fuente plat à servir

| REF | (cm) | |
|-------------|---------------|--------|
| 04336900441 | 20.3x13.3x1.8 | 01/018 |

INTERIOR ESMALTADO ENAMELED INTERIOR
INTERIOR ESMALTADO INTÉRIEUR ÉMAILLÉ



FERRO
IRON
HIERRO
FER

MADEIRA
WOOD
MADERA
BOIS



PRATO
plate plato assiette

| REF | (cm) | |
|-------------|------|--------|
| 04336900681 | Ø22 | 01/012 |

contém: 1 asa amovível
contains: 1 removable handle
contiene: 1 asa removible
contient: 1 poignée



FERRO
IRON
HIERRO
FER

MADEIRA
WOOD
MADERA
BOIS



PRATO OVAL
oval plate plato oval assiette ovale

| REF | (cm) | |
|------------|----------|--------|
| 0433690428 | Ø28x19x2 | 01/012 |

contém: 1 asa amovível
contains: 1 removable handle
contiene: 1 asa removible
contient: 1 poignée



FERRO
IRON
HIERRO
FER

MADEIRA
WOOD
MADERA
BOIS

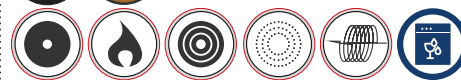

FRIGIDEIRA
frypan sartén poêle

| REF | (cm) | |
|-------------|-----------|--------|
| 04336900141 | Ø22.3x4.1 | 01/006 |



FERRO
IRON
HIERRO
FER

MADEIRA
WOOD
MADERA
BOIS

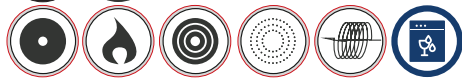

FRIGIDEIRA
frypan sartén poêle

| REF | (cm) | |
|------------|-----------|--------|
| 0433690019 | Ø25.5x4.7 | 01/006 |



FERRO
IRON
HIERRO
FER

MADEIRA
WOOD
MADERA
BOIS

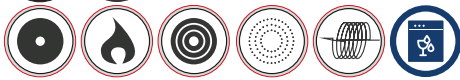

FRIGIDEIRA
frypan sartén poêle

| REF | (cm) | |
|------------|-----------|--------|
| 0433690074 | Ø30.2x6.7 | 01/002 |



FERRO
IRON
HIERRO
FER

MADEIRA
WOOD
MADERA
BOIS

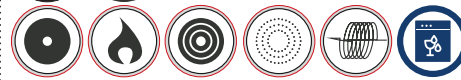

FRIGIDEIRA
frypan sartén poêle

| REF | (cm) | |
|-------------|-----------|--------|
| 04336900751 | Ø30.5x6.2 | 01/004 |

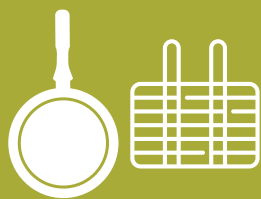

FRIGIDEIRAS/GRELHADORES
fry pans/grills sartenes/parrillas poêles/grils



0,8~1,2mm

4mm
Protector
430/0,8mm

ANTIADERENTE DYFLON

Revestimento antiaderente DYFLON (com duas camadas) - preto exterior em alumínio natural

Non-stick coating DYFLON (with two layers) - black natural aluminum exterior

Revestimiento antiadherente DYFLON (con dos capas) - negro exterior de aluminio natural

Revêtement antiadhésif DYFLON (avec deux couches) - noire extérieur en aluminium naturel



cozinha kitchen cuisine



antiaderente
Non-stick
antiadherente
antadhésif



LINHA PROFISSIONAL EM ALUMÍNIO

professional linea aluminum línea profesional aluminum ligne professionnelle aluminum



FRIGIDEIRA
frypan sartén poêle



| REF | (cm) | | |
|------------|---------|-----|--------|
| 0433431640 | Ø16x4 | 4mm | 01/012 |
| 0433432040 | Ø20x4 | 4mm | 01/006 |
| 0433432450 | Ø24x5 | 4mm | 01/006 |
| 0433432655 | Ø26.5x5 | 4mm | 01/006 |
| 0433432865 | Ø28x6.5 | 4mm | 01/012 |
| 0433433065 | Ø30x6.5 | 4mm | 01/012 |
| 0433433265 | Ø32x6.5 | 4mm | 01/012 |



FRIGIDEIRA
frypan sartén poêle

| REF | (cm) | | |
|------------|---------|-----|--------|
| 0433433670 | Ø36x7 | 5mm | 01/006 |
| 0433434075 | Ø40x7.5 | 5mm | 01/006 |
| 0433435075 | Ø50x7.5 | 5mm | 01/006 |



CAÇAROLETE C/CABO EM INOX
cassarole cazo casserole



| REF | (cm) | | LT | |
|------------|---------|-----|-----|--------|
| 0433431675 | Ø16x7.5 | 4mm | 0.4 | 01/012 |



FRIGIDEIRA C/CABO EM INOX
frypan sartén poêle

| REF | (cm) | | |
|------------|---------|-----|--------|
| 0432460009 | Ø28x6.5 | 3mm | 01/012 |



PAELHEIRA
paella pan paellera poêle à paella

| REF | (cm) | | |
|------------|---------|-----|--------|
| 0433433045 | Ø30x4.5 | 3mm | 01/012 |
| 0433435050 | Ø50x5 | 4mm | 01/006 |



ANTIADERENTE
TEFLON

Com um antiaderente excepcional (Teflon), uma espessura elevada, exterior com acabamento satinado e uma zona na pega em aço inox #304, esta é uma linha de produtos altamente recomendada para os profissionais mais exigentes.

With an exceptional non-stick (Teflon), a thickness high, its exterior with a satin finish and place the handle in stainless steel # 304, this is a highly recommended product line for the most demanding professionals.

Con una excepcional antiadherente (teflón), un alto espesor, su exterior con un acabado satinado y coloque el mango en acero inoxidable # 304, se trata de una línea de productos altamente recomendado para los profesionales más exigentes.

Avec un antiadhésif exceptionnel (Téflon), une large épaisseur, un revêtement extérieur avec finition satinée et une partie de la poignée en acier inoxydable # 304, c'est une ligne de produits hautement recommandés pour les professionnels les plus exigeants.

FRIGIDEIRA C/CABO EM INOX
frypan sartén poêle

| REF | (cm) | | |
|-------------|-------|-----|--------|
| 04308200281 | Ø28x7 | 4mm | 01/012 |

FRIGIDEIRA
frypan sartén poêle

| REF | (cm) | | |
|------------|-------|-------|--------|
| 0430682203 | Ø20x6 | 3.5mm | 01/006 |
| 0430682206 | Ø26x6 | 3.5mm | 01/006 |

CREPEIRA P/INDUÇÃO
crêpe maker crêpera crêpière

| REF | (cm) | | |
|------------|-------|-----|--------|
| 0433430026 | Ø26x2 | 4mm | 01/006 |

FRIGIDEIRA
frypan sartén poêle

| REF | (cm) | | |
|-------------|------------|-------|--------|
| 04307500162 | Ø16x33x4 | 2.5mm | 01/012 |
| 04307500182 | Ø18x35x4 | 2.5mm | 01/012 |
| 04307500203 | Ø20x37x4.5 | 2.5mm | 01/012 |
| 04307500224 | Ø22x39x5 | 2.5mm | 01/012 |
| 04307500245 | Ø24x42.5x5 | 2.5mm | 01/012 |
| 04307500265 | Ø26x45x5 | 2.5mm | 01/012 |
| 04307500285 | Ø28x47x5.5 | 2.5mm | 01/012 |

LINHA PROFISSIONAL EM ALUMÍNIO FORJADO

professional linea aluminum
línea profesional aluminum
ligne professionnelle aluminum

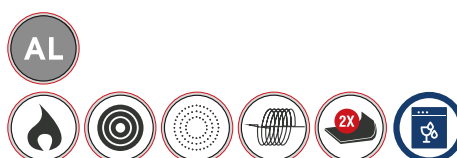
FRIGIDEIRA
frypan sartén poêle

| REF | (cm) | | |
|-------------|---------|-------|--------|
| 0433432045 | Ø20x4.5 | 4.6mm | 01/012 |
| 0433432245 | Ø22x4.5 | 4.6mm | 01/012 |
| 04334324501 | Ø24x5 | 4.6mm | 01/012 |
| 04334326551 | Ø26x5.5 | 4.6mm | 01/012 |
| 0433432860 | Ø28x6 | 4.6mm | 01/012 |



Revestimento antiaderente DYFLON (2 camadas)
exterior e interior preto

Non-stick coating DYFLON (2 layers) - black
black exterior and interior

Revestimiento antiadherente DYFLON (2 capas)
exterior e interior negro

Revêtement antiadhésif DYFLON (2 couches)
extérieur et intérieur noir



Grilhar... sem gordura e sem fumo

grilling...
without fat and smoke free

assar...
ala parrilla sin grasa e libre de humo

griller...
sans graisse et sans fume

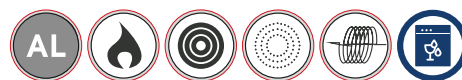

GRELHADOR PROFISSIONAL
grill grill gril

| REF | (cm) | |
|------------|-------------|--------|
| 0433446546 | 46x26x2.2cm | 01/008 |

alumínio forjado **forged aluminum**
aluminio forjado **aluminium forgé**

ANTIADERENTE **XILAN PLUS** DUPLA CAMADA

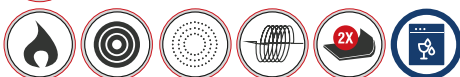

GRELHADOR
grill grill gril

| REF | (cm) | |
|------------|-------------|--------|
| 0433446629 | 29x22.5x1.6 | 01/006 |
| 0433446638 | 38x28.5x1.7 | 01/008 |

contém: 2 pegas amovíveis em silicone
contains: 2 removable silicone handles
contiene: 2 asas de silicona extraíbles
contient: 2 poignées en silicone amovibles

ANTIADERENTE **WHITFORD** XILAN PLUS

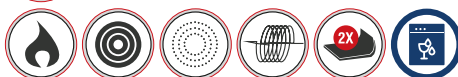

GRELHADOR
grill grill gril

| REF | (cm) | |
|------------|--------|--------|
| 0433444524 | 24x3.6 | 01/020 |
| 0433444528 | 28x3.8 | 01/020 |

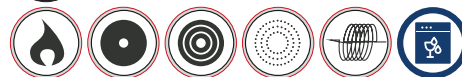

GRELHADOR
grill grill gril

| REF | (cm) | |
|------------|------|--------|
| 0433690075 | Ø27 | 01/008 |

ferro fundido **cast iron** hierro fundido **fonte**



GRELHADOR
grill grill gril

| REF | (cm) | |
|------------|---------|--------|
| 0433690051 | 35x21x2 | 01/008 |

ferro fundido **cast iron** hierro fundido **fonte**



GRELHADOR
grill grill gril

| REF | (cm) | |
|------------|-------|--------|
| 0438662622 | 26x22 | 01/001 |

alumínio fundido **cast aluminum**
aluminio fundido **aluminium fondu**



TABULEIROS/ACESSÓRIOS

roaster/accessories

rustideras/accesorios

plateau à rotir/accessoires





INOX

TABULEIRO OVAL
roaster rustidera plat à rotir

| REF | (cm) | |
|------------|-------|--------|
| 0433650126 | Ø36x5 | 01/015 |



INOX

TABULEIRO
roaster rustidera plat à rotir

| REF | (cm) | |
|------------|-----------|--------|
| 0433780002 | 32x32x6.5 | 01/120 |



INOX

TABULEIRO
roaster rustidera plat à rotir

| REF | (cm) | |
|------------|-------------|--------|
| 0433657735 | 35x26.5x7.2 | 01/010 |



INOX

TABULEIRO
roaster rustidera plat à rotir

| REF | (cm) | |
|------------|---------|--------|
| 0433840144 | 45x33x7 | 01/006 |



INOX

TABULEIRO
roaster rustidera plat à rotir

| REF | (cm) | |
|------------|-----------|--------|
| 0433495125 | 48.6x34x8 | 01/030 |



INOX

TABULEIRO C/ASAS
roaster rustidera plat à rotir

| REF | (cm) | |
|-------------|-----------|--------|
| 04324300401 | 40x30x0.7 | 00/000 |



INOX

TABULEIRO C/ASAS
roaster rustidera plat à rotir

| REF | (cm) | |
|------------|-----------|--------|
| 0433780099 | 40x28x6.5 | 01/024 |



INOX

TAMPA P/TABULEIRO
lid for roaster tapa para rustidera couvercle pour plat à rotir

| REF | (cm) | |
|------------|-------|--------|
| 0433780715 | 40x28 | 01/060 |



INOX

TABULEIRO C/ASAS
roaster rustidera plat à rotir

| REF | (cm) | |
|------------|-----------|--------|
| 0433780183 | 40x28x6.7 | 01/120 |



INOX

TABULEIRO C/ASAS
roaster rustidera plat à rotir

| REF | (cm) | |
|-------------|-----------|--------|
| 04336501921 | 45x32x7.5 | 01/004 |
| 0433650192 | 40x28x5.5 | 01/006 |



INOX

TABULEIRO
roaster rustidera plat à rotir

| REF | (cm) | |
|------------|-----------|--------|
| 0431260360 | 36x19x1.5 | 01/024 |



INOX

TABULEIRO
roaster rustidera plat à rotir

| REF | (cm) | |
|------------|-------|--------|
| 0432794030 | 40x30 | 08/024 |



TABULEIROS/ACESSÓRIOS

roaster/accessories rustideras/accesorios plateau à rotir/accessoires

TABULEIRO C/ASAS
roaster rustidera plat à rotir

| REF | (cm) | |
|------------|-----------|--------|
| 0433780857 | 60x40x9.5 | 01/080 |
| 0433780858 | 50x36x9 | 01/120 |

TABULEIRO C/ASAS
roaster rustidera plat à rotir

| REF | (cm) | |
|------------|-----------|--------|
| 0432430060 | 60x40x9.2 | 01/004 |
| 0432430050 | 50x36x8.5 | 01/004 |

TABULEIRO C/ASAS
roaster rustidera plat à rotir

| REF | (cm) | |
|------------|---------|--------|
| 0433495110 | 60x40x5 | 01/005 |

TABULEIRO C/ASAS
roaster rustidera plat à rotir

| REF | (cm) | |
|-------------|---------|--------|
| 04306820702 | 65x45x5 | 01/020 |

TABULEIRO
roaster rustidera plat à rotir

| REF | (cm) | |
|------------|---------|--------|
| 0433890290 | 60x40x3 | 01/020 |

TABULEIRO
roaster rustidera plat à rotir

| REF | (cm) | | |
|-------------|-----------|-------|--------|
| 04312600051 | 53x42x7 | 1.5mm | 01/010 |
| 04312600042 | 47x35x5x7 | 1.5mm | 01/010 |

TABULEIRO
roaster rustidera plat à rotir

| REF | (cm) | |
|------------|---------|--------|
| 0433900030 | 60x40x3 | 01/025 |

TABULEIRO
roaster rustidera plat à rotir

| REF | (cm) | | |
|-------------|---------|-------|--------|
| 04312600113 | 60x40x2 | 1.5mm | 01/010 |



antiaderente
Non-stick
antiaderente
antiadhesif

AL

TABULEIRO
roaster rustidera plat à rotir

| REF | (cm) | | |
|------------|---------|-------|--------|
| 1330381072 | 60x40x2 | 1.6mm | 01/006 |



AL

TABULEIRO P/PADARIA
bakery tray bandeja de panaderia plateau boulangerie

| REF | (cm) | |
|------------|-------|--------|
| 1330381587 | 60x40 | 01/001 |

para baguete for long bread para baguette pour baguette

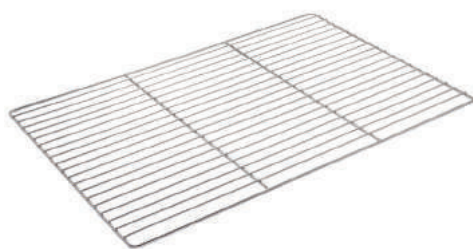

INOX

GRELHA
grate parrila grille

| REF | (cm) | |
|------------|-------|--------|
| 0433900064 | 60x40 | 01/020 |



INOX

GRELHA
grate parrila grille

| REF | (cm) | |
|------------|-------|---------------|
| 0430687125 | 65x53 | GN 2/1 01/005 |

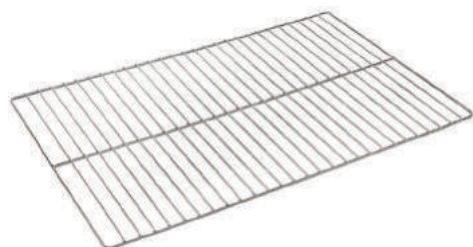

INOX

GRELHA
grate parrila grille

| REF | (cm) | |
|------------|-------|--------|
| 0431266040 | 60x40 | 01/024 |



INOX

GRELHA
grate parrila grille

| REF | (cm) | |
|-------------|---------|---------------|
| 04339000111 | 53x32.5 | GN 1/1 01/020 |

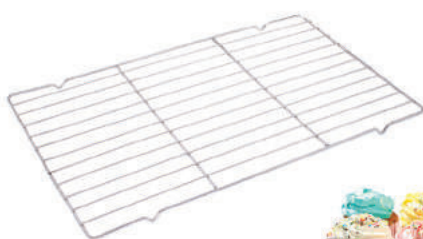

INOX

GRELHA
grate parrila grille

| REF | (cm) | |
|------------|---------|---------------|
| 0433658153 | 53x32.5 | GN 1/1 01/030 |

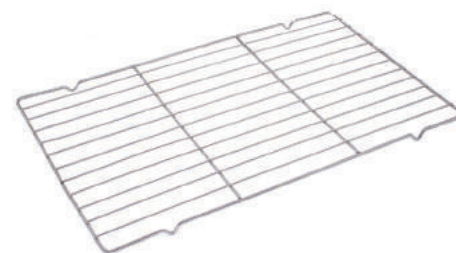

INOX

GRELHA
grate parrila grille

| REF | (cm) | |
|------------|-------|--------|
| 0433658160 | 60x40 | 01/020 |



TABULEIROS/ACESSÓRIOS

roaster/accessories rustideras/accesorios plateau à rotir/accessoires

PINÇA P/TABULEIROS
fong pinza pince

| REF | (cm) | |
|------------|--------|--------|
| 0433652801 | 19x2.6 | 00/000 |

PINÇA P/TABULEIROS
fong pinza pince

| REF | (cm) | |
|---|------|--|
| 04324300014 | 18 | 01/048 |
| abertura máx. 4cm apertura máx. 4 cm | | opening max. 4 cm ouverture max. 4 cm |

PINÇA P/TABULEIROS
fong pinza pince

| REF | (cm) | |
|--|------|--|
| 04327900017 | 20 | 12/120 |
| abertura máx. 2cm apertura máx. 2cm | | opening max. 2cm ouverture max. 2cm |

Luva extra longa, perfeita para agarrar objectos frios quentes (fornos, panelas, assadeiras,) sem ter risco de queimadura.
Fácil de lavar.

Extra long glove, perfect for grabbing cold/hot objects (ovens, pans, roasting pans) without any risk of burns.
Easy to wash.

Guante extra largo, perfecto para agarrar objetos frios/calientes (hornos, ollas, bandejas de horno) sin riesgo de quemaduras.
Fácil de lavar.

Gant extra long, idéal pour saisir des objets froids/chauds (fours, casseroles, plaques de cuisson) sans risque de brûlures.
Facile à laver.

LUA EM SILICONE/ALGODÃO
oven glove guante horno gant à four

| REF | (cm) | |
|-------------|-------|--------|
| 04322700015 | 44x15 | 01/036 |



+ 500° for 30seg

LUA FORNO 100%ALGODÃO
cotton oven glove guante horno algodón gant à four

| REF | (cm) | |
|-------------|------|--------|
| 04307200015 | 38 | 01/072 |

+ 200°

LUA EM ALGODÃO
oven glove guante horno gant à four

| REF | (cm) | |
|-------------|------|--------|
| 04314800030 | 30 | 01/072 |
| 04314800035 | 35 | 01/072 |

revestimento em alumínio aluminum coating
revestimiento de aluminio revêtement en aluminium

+ 230°

LUA EM SILICONE/ALGODÃO
oven glove guante horno gant à four

| REF | (cm) | |
|-------------|------|--------|
| 04338700001 | 36 | 01/050 |



ACESSÓRIOS P/PIZZA

pizza accessories accesorios pizza accessoires pizza



AL

PÁ PIZZA

pizza peel pala pizza pelle à enfourner

| REF | (cm) | |
|-------------|---------------|-------------------------------|
| 04312600352 | 40.5x35 50 | cabo cable cable câble 01/012 |
| 04312600353 | 40.5x35 100 | cabo cable cable câble 01/012 |



AL

FORMA PIZZA

pizza mould molde pizza moule pizza

| REF | (cm) | |
|-------------|------|--------|
| 04312600171 | Ø43 | 01/050 |
| 04312600181 | Ø46 | 01/050 |
| 04312600203 | Ø51 | 01/025 |



AL

FORMA PIZZA COUPE

pizza mould molde pizza moule pizza

| REF | (cm) | |
|-------------|------|--------|
| 04312600119 | Ø28 | 01/050 |
| 04312600132 | Ø33 | 01/050 |
| 04312690141 | Ø36 | 01/050 |
| 04312600172 | Ø43 | 01/072 |



AL

BASE PIZZA ROBUSTA

pizza screen base para pizza base pour pizza

| REF | (cm) | |
|-------------|------|--------|
| 04312600084 | Ø20 | 01/144 |
| 04312600118 | Ø28 | 01/144 |
| 04312690122 | Ø30 | 01/144 |
| 04312600153 | Ø38 | 01/072 |
| 04312600165 | Ø40 | 01/072 |



AL

BASE PIZZA

pizza screen base para pizza base pour pizza

| REF | (cm) | |
|-------------|------|--------|
| 0430681703 | Ø20 | 12/168 |
| 0430681710 | Ø38 | 12/048 |
| 0431260016 | Ø41 | 12/072 |
| 04312600202 | Ø50 | 12/072 |



METAL

BASE PIZZA

pizza screen base para pizza base pour pizza

| REF | (cm) | |
|------------|------|--------|
| 0430681401 | Ø35 | 01/012 |



CAIXA P/PIZZA

pizza box caja para pizza emballage à pizza

| REF | (cm) | |
|------------|-------|--------|
| 1533733333 | 33x33 | 01/050 |
| 1533733636 | 36x36 | 01/050 |
| 1533734040 | 40x40 | 01/050 |
| 1533735050 | 50x50 | 01/050 |



INOX

SUPORTE P/TABULEIRO

support for tray soporte para fuente support pour plateau

| REF | (cm) | |
|------------|------------|--------|
| 0733610033 | 15x21x23.5 | 12/024 |



UTENSÍLIOS COZINHA

kitchen utensils utensilios cocina ustensiles cuisine

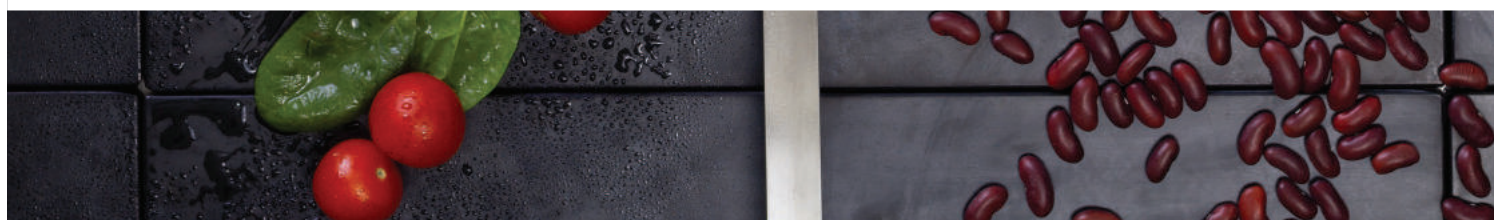

INOX



ESCUMADEIRA D/ARAME FUNDA

finned skimmer espumadera alambre écumoire étamée

| REF | (cm) | | |
|------------|----------|--|--------|
| 0434071114 | Ø14x39 | | 01/200 |
| 0434071118 | Ø18x43.3 | | 01/200 |

INOX



ESCUMADEIRA D/REDE

finned skimmer espumadera alambre écumoire étamée

| REF | (cm) | | |
|------------|--------|--|--------|
| 0430682623 | Ø16x43 | | 01/060 |

INOX



ESCUMADEIRA D/REDE

finned skimmer espumadera alambre écumoire étamée

| REF | (cm) | | |
|-------------|--------|--|--------|
| 0431260017 | Ø17x39 | | 12/144 |
| 04312600191 | Ø19x41 | | 12/144 |



INOX



ESCUMADEIRA D/REDE

finned skimmer espumadera alambre écumoire étamée

| REF | (cm) | | |
|------------|--------|--|--------|
| 0431261200 | Ø12x49 | | 01/072 |
| 0431261600 | Ø16x53 | | 01/072 |

INOX



ESCUMADEIRA D/ARAME

finned skimmer espumadera alambre écumoire étamée

| REF | (cm) | | |
|-------------|--------|--|--------|
| 04324300242 | Ø24x59 | | 01/036 |



INOX

ESCUMADEIRA D/REDE

finned skimmer espumadera alambre écumoire étamée

| REF | (cm) | | |
|-------------|----------|---|--------|
| 0433657220 | Ø20x67 | 1 | 01/025 |
| 0433657216 | Ø16x48 | | 01/050 |
| 0433657212 | Ø12x48 | | 01/050 |
| 04312600072 | Ø18x51 | 2 | 25/050 |
| 04312600061 | Ø15x48 | | 12/048 |
| 04327900201 | Ø20x66.5 | 3 | 05/048 |

INOX



CONCHA MONOBLOCO

monobloc ladle cacillo monobloque louche monobloc

| REF | (cm) | CL | |
|------------|--------|------|--------|
| 0433653308 | Ø8x32 | 12.5 | 01/060 |
| 0433653310 | Ø10x37 | 25 | 01/040 |
| 0433653312 | Ø12x43 | 50 | 01/040 |
| 0433653314 | Ø14x44 | 75 | 01/040 |

INOX



GARFO

fork tenedor fourchette

| REF | (cm) | | |
|-------------|--------|--|--------|
| 04312600254 | 50x4.2 | | 10/060 |

INOX



ESCUMADEIRA MONOBLOCO

skimmer espumadera écumoire

| REF | (cm) | | |
|------------|----------|--|--------|
| 0433653410 | Ø10x41 | | 01/060 |
| 0433653412 | Ø12x44.5 | | 01/040 |
| 0433653414 | Ø14x49 | | 01/040 |
| 0433653416 | Ø16x48 | | 01/040 |



UTENSÍLIOS COZINHA

kitchen utensils utensilios cocina ustensiles cuisine

COLHER SERVIR
spoon cuchara cuillère

| REF | (cm) | |
|-------------|--------|--------|
| 04312600213 | 36x6.5 | 12/120 |

COLHER SERVIR
spoon cuchara cuillère

| REF | (cm) | |
|------------|------|--------|
| 0432790047 | 38x7 | 04/120 |

COLHER SERVIR
spoon cuchara cuillère

| REF | (cm) | |
|-------------|----------|--------|
| 04312600255 | 25.7x5.7 | 01/240 |
| 04312600323 | 32.5x7 | 01/120 |

ESPÁTULA
spatula espátula spatule

| REF | (cm) | |
|-------------|-------|--------|
| 04312600232 | 53x12 | 12/120 |

ESPÁTULA D/PEIXE
fish turner paleta de pesacdo pelle à poison

| REF | (cm) | |
|-------------|--------|--------|
| 04312600401 | 41x9.8 | 12/144 |

ESCU MADEIRA ROBUSTA MONOBLOCO
skimmer espumadera écumoire

| REF | (cm) | |
|-------------|--------|--------|
| 04312600162 | Ø16x57 | 10/040 |

CONCHA ROBUSTA MONOBLOCO
monobloc ladle cacillo monobloque louche monobloc

| REF | (cm) | CL | |
|-------------|---------|-----|--------|
| 04312600065 | Ø6.5x37 | 7 | 10/120 |
| 04312600144 | 53xØ14 | 75 | 05/020 |
| 04312600164 | 59xØ16 | 100 | 05/020 |

CONCHA MONOBLOCO
monobloc ladle cacillo monobloque louche monobloc

| REF | (cm) | CL | |
|-------------|------------|----|--------|
| 04324300101 | 1 101x34.5 | 15 | 01/120 |
| 04324300091 | Ø9x33 | 10 | 00/072 |
| 04312600147 | 2 014x50 | 75 | 01/010 |
| 04312600101 | Ø10x42 | 25 | 10/060 |
| 04312600082 | Ø8x36 | 12 | 10/100 |
| 04312600039 | 3 07.7x36 | 9 | 12/144 |
| 04312600041 | Ø8x35 | 12 | 12/144 |
| 04312600062 | Ø9x38 | 18 | 12/144 |





INOX



ESCUMADEIRA MONOBLOCO
skimmer espumadera écumoire

| REF | (cm) | |
|------------|----------|--------|
| 0432430013 | Ø12x38.5 | 02/012 |

INOX



CONCHA
ladle cacillo louche

| REF | (cm) | CL | |
|-------------|-------|------|--------|
| 04312600075 | Ø9x33 | 0.95 | 12/072 |

INOX



COLHER
spoon cuchara cuillère

| REF | (cm) | |
|-------------|------|--------|
| 04312600024 | 37x7 | 12/072 |

INOX



COLHER P/ESPARGUETE
spaguetti spoon cuchara espaguetis cuillère à spaguetis

| REF | (cm) | |
|-------------|-----------|--------|
| 04312600066 | Ø6.9x32.5 | 12/072 |

INOX



COLHER PROFESSIONAL
spoon cuchara cuillère

| REF | (cm) | |
|-------------|--------|--------|
| 04312600114 | 28x6.5 | 12/144 |
| 04312600251 | 38x6.9 | 12/144 |

INOX



COLHER PERFURADA
perforated spoon cuchara perforada cuillère perforée

| REF | (cm) | |
|------------|--------|--------|
| 0430725132 | 33x6.2 | 12/120 |

INOX



COLHER
spoon cuchara cuillère

| REF | (cm) | |
|------------|--------|--------|
| 0433940301 | 34x6.7 | 01/300 |

INOX

ABS



COLHER PROFESSIONAL
spoon cuchara cuillère

| REF | (cm) | |
|------------|--------|--------|
| 0431260013 | 33x6.5 | 12/144 |

INOX



COLHER PROFESSIONAL
spoon cuchara cuillère

| REF | (cm) | |
|-------------|--------|--------|
| 04339430011 | 33.5x7 | 01/120 |
| 0433943001 | 43x7 | 01/120 |



UTENSÍLIOS COZINHA

kitchen utensils utensilios cocina ustensiles cuisine

INOX



CONCHA MONOBLOCO

monobloc ladle cacillo monobloque louche monobloc

| REF | (cm) | CL | |
|------------|--------|----|--------|
| 0433988008 | Ø8x39 | 12 | 10/040 |
| 0433988012 | Ø12x51 | 50 | 10/040 |
| 0433988014 | Ø14x53 | 75 | 10/040 |

INOX



ESCUMADEIRA MONOBLOCO

skimmer espumadera écumoire

| REF | (cm) | |
|------------|----------|--------|
| 0433943011 | Ø10.5x40 | 01/120 |

INOX



ESCUMADEIRA MONOBLOCO

skimmer espumadera écumoire

| REF | (cm) | |
|------------|--------|--------|
| 0431260010 | Ø10x41 | 10/100 |

INOX



ESCUMADEIRA MONOBLOCO

skimmer espumadera écumoire

| REF | (cm) | |
|------------|--------|--------|
| 0433653416 | Ø16x53 | 01/040 |

INOX



ESCUMADEIRA MONOBLOCO

skimmer espumadera écumoire

| REF | (cm) | |
|-------------|----------|--------|
| 04339880141 | Ø14x56.5 | 10/040 |
| 0433988016 | Ø16x58.5 | 10/060 |
| 0433988020 | Ø20x62 | 10/020 |

INOX



ESPÁTULA

spatula espátula spatule

| REF | (cm) | |
|-------------|--------|--------|
| 04339880161 | 47x9.7 | 10/040 |

INOX



GARFO

fork tenedor fourchette

| REF | (cm) | |
|------------|--------|--------|
| 0433943008 | 42x3.2 | 01/120 |

INOX



GARFO MONOBLOCO

fork tenedor fourchette

| REF | (cm) | |
|------------|------|--------|
| 0433653752 | 52x3 | 01/072 |

INOX



CONCHA P/MOLHOS

ladle for sauces cacillo para salsas louche à sauces

| REF | (cm) | CL | |
|-------------|---------|----|--------|
| 04312600038 | Ø7.7x18 | 9 | 12/240 |

INOX



CONCHA P/MOLHOS

ladle for sauces cacillo para salsas louche à sauces

| REF | (cm) | CL | |
|-------------|--------|----|--------|
| 04307220011 | 31x7.5 | 3 | 12/144 |

INOX



CONCHA

ladle cacillo louche

| REF | (cm) | CL | |
|------------|-------|-----|--------|
| 0434072113 | Ø8x35 | 6.5 | 01/024 |

INOX



CONCHA

ladle cacillo louche

| REF | (cm) | CL | |
|-------------|-----------|-----|--------|
| 04324300061 | Ø5.7x18.5 | 4.5 | 01/156 |
| 04324300071 | Ø7x21 | 7 | 01/120 |



INOX

CONCHA
ladle cacillo louche

| REF | (cm) | CL | |
|-------------|---------|------|--------|
| 04340700331 | Ø6.3x35 | 12.5 | 01/200 |



INOX

GARFO
fork tenedor fourchette

| REF | (cm) | |
|------------|--------|--------|
| 0430723011 | 29x2.2 | 12/144 |



INOX

ESPÁTULA D/PEIXE
fish turner paleta de pescado pelle à poisson

| REF | (cm) | |
|------------|--------|--------|
| 0433658114 | 34x7.5 | 01/238 |



INOX

CONCHA
ladle cacillo louche

| REF | (cm) | CL | |
|------------|-----------|----|--------|
| 0434071712 | Ø8.2x27.5 | 9 | 01/300 |



INOX

COLHER SERVIR
spoon cuchara cuillère

| REF | (cm) | |
|------------|------|--------|
| 0434071718 | 31.2 | 01/300 |

INOX

ESCUMADEIRA
skimmer espumadera écumoire

| REF | (cm) | |
|------------|------------|--------|
| 0434071714 | Ø10.7x31.7 | 01/300 |



INOX

CONCHA MONOBLOCO
monobloc ladle cacillo monobloque louche monobloc

| REF | (cm) | CL | |
|------------|---------|-----|--------|
| 0430972700 | Ø8.5x27 | 6.5 | 12/072 |



INOX

COLHER P/ARROZ
rice spoon cuchara de arroz cuillère à riz

| REF | (cm) | |
|-------------|------|--------|
| 04309727001 | 33 | 12/072 |

INOX

GARFO
fork tenedor fourchette

| REF | (cm) | |
|-------------|------|--------|
| 04309727002 | 33x3 | 12/072 |



INOX

COLHER P/ESPARGUETE
spaguetti spoon cuchara espaguetis cuillère à spaguetis

| REF | (cm) | |
|-------------|---------|--------|
| 04324300092 | Ø7x21.5 | 00/072 |





UTENSÍLIOS COZINHA

kitchen utensils utensilios cocina ustensiles cuisine



INOX

CONCHA LARA
ladle cacillo louche

| REF | (cm) | CL | | |
|------------|------|--------|------|--------|
| 0433652621 | 1 | 33x8.8 | 0.95 | 12/144 |

COLHER LARA
rice spoon cuchara de arroz cuillère à riz

| REF | (cm) | | |
|------------|------|--------|--------|
| 0433652622 | 2 | 33x6.2 | 12/144 |

GARFO LARA
fork tenedor fourchette

| REF | (cm) | | |
|------------|------|------|--------|
| 0433652623 | 3 | 33x3 | 12/144 |

COLHER P/ESPARGUETE LARA
spaguetfi spoon cuchara espaguetis cuillère à spaguetis

| REF | (cm) | | |
|------------|------|------|--------|
| 0433652624 | 4 | 33x8 | 12/144 |

ESPÁTULA LARA
spatula espátula spatule

| REF | (cm) | | |
|------------|------|--------|--------|
| 0433652625 | 5 | 33x7.8 | 12/144 |

ESCUMAIDEIRA LARA
skimmer espumadera écumoire

| REF | (cm) | | |
|------------|------|--------|--------|
| 0433652626 | 6 | 33xØ10 | 12/144 |



INOX NYLON

CONCHA
ladle cacillo louche

| REF | (cm) | | |
|------------|------|---------|--------|
| 0430972761 | 1 | 33xØ8.5 | 12/072 |

COLHER P/ARROZ
rice spoon cuchara de arroz cuillère à riz

| REF | (cm) | | |
|-------------|------|--------|--------|
| 04309727614 | 2 | 33x6.2 | 12/072 |

COLHER P/ESPARGUETE
spaguetfi spoon cuchara espaguetis cuillère à spaguetis

| REF | (cm) | | |
|-------------|------|--------|--------|
| 04309727613 | 3 | 33x6.8 | 12/072 |

ESPÁTULA
spatula espátula spatule

| REF | (cm) | | |
|-------------|------|------|--------|
| 04309727612 | 4 | 33x8 | 12/072 |

ESCUMAIDEIRA
skimmer espumadera écumoire

| REF | (cm) | | |
|-------------|------|----------|--------|
| 04309727611 | 5 | 33xØ11.2 | 12/072 |



NYLON

CONCHA
ladle cacillo louche

| REF | (cm) | | |
|------------|------|-------|--------|
| 0432270202 | 1 | 30xØ9 | 24/096 |

COLHER P/ARROZ
rice spoon cuchara de arroz cuillère à riz

| REF | (cm) | | |
|------------|------|--------|--------|
| 0432270201 | 2 | 30x6.7 | 24/096 |

COLHER P/ESPARGUETE
spaguetfi spoon cuchara espaguetis cuillère à spaguetis

| REF | (cm) | | |
|------------|------|--------|--------|
| 0432270203 | 3 | 30x6.2 | 24/096 |

ESPÁTULA
spatula espátula spatule

| REF | (cm) | | |
|------------|------|--------|--------|
| 0432270205 | 4 | 31.5x9 | 24/096 |

ESPÁTULA P/FRITOS
spatula espátula spatule

| REF | (cm) | | |
|------------|------|------|--------|
| 0430721134 | 5 | 30x8 | 12/240 |

ESCUMAIDEIRA
skimmer espumadera écumoire

| REF | (cm) | | |
|------------|------|--------|--------|
| 0432270204 | 6 | 33xØ11 | 24/096 |



A colher de polícarbonato Lizotel, tem algumas particularidades que a distingue. Elevada qualidade, elevada durabilidade e material mais higiénico, mas a sua verdadeira diferença está no formato das mesmas que são em tudo iguais à tradicional colher de pau.

Spoon polycarbonate Lizotel has some peculiarities that distinguish it. High quality, high durability materials and more hygienic, but its true difference is in the same format that they are all equal in the traditional wooden spoon.

Cuchara de polícarbonato Lizotel tiene algunas particularidades que lo distinguen. Alta calidad, materiales de alta durabilidad y más higiénico, pero su verdadero diferencia está en el mismo formato que son todos iguales en el tradicional cuchara de madera.

La cuillère en polycarbonate Lizotel a quelques particularités qui la distinguent. Avec des matériaux d'une longévité de haute qualité, plus hygiénique, la vraie différence réside dans leur formes toutes identiques à la traditionnelle cuillère en bois.



PC

COLHER (FORMATO EXCLUSIVO)
spoon cuchara cuillère

| REF | (cm) |  |
|------------|---------|--|
| 0733240030 | 30xØ6.2 | 00/006 |
| 0733240040 | 40xØ6.2 | 00/006 |
| 0733240050 | 50xØ6.2 | 00/006 |



MELAMINA
melamine

COLHER
spoon cuchara cuillère

| REF | (cm) |  |
|------------|---------|---|
| 0732563908 | 31xØ5.7 | 40/240 |



MELAMINA
melamine

COLHER
spoon cuchara cuillère

| REF | (cm) |  |
|------------|---------|---|
| 0732563896 | 38xØ6.3 | 20/120 |
| 0732563897 | 45xØ7.3 | 20/120 |
| 0732563898 | 55xØ8.5 | 15/030 |



MELAMINA
melamine

COLHER SERVIR
spoon cuchara cuillère

| REF | (cm) |  |
|------------|--------------|---|
| 0734127009 | 31.7x7.3x4.6 | 100/200 |

cor marfim ivory color color marfil couleur ivoire



MELAMINA
melamine

COLHER PERFURADA
spoon cuchara cuillère

| REF | (cm) |  |
|------------|----------|---|
| 0734127011 | 27.5x7.5 | 150/300 |

cor marfim ivory color color marfil couleur ivoire



MELAMINA
melamine

CONCHA
ladle cachilo louche

| REF | (cm) |  |
|------------|--------------|---|
| 0734127010 | 1 20.4x6.5x2 | 250/500 |
| 0734127011 | 2 20.4x6.5x2 | 150/600 |

cor marfim ivory color color marfil couleur ivoire



APRESENTAÇÃO
presentation
presentación
présentation

pg. 202/219





UTENSÍLIOS COZINHA

kitchen utensils utensilios cocina ustensiles cuisine



PINÇA CHEF

chef tong pinza chef pince chef

| REF | (cm) | | |
|-------------|------|----|--------|
| 0433940006 | 15.5 | ** | 01/600 |
| 04339400091 | 23 | | 01/600 |

**pinça de precisão *precision tong*
pinza de precisión *pince de précision*



PINÇA CHEF

chef tong pinza chef pince chef

| REF | (cm) | | |
|------------|------|--|--------|
| 0430682111 | 30.5 | | 24/144 |



PINÇA CURVA

fong pinza pince

| REF | (cm) | | |
|------------|------|--|--------|
| 0432790035 | 35 | | 12/120 |



PINÇA P/EMPRATAR

serving tong pinza servir pince à servir

| REF | (cm) | | |
|------------|------|--|--------|
| 0730750496 | 29 | | 12/072 |



PINÇA P/SERVIR

serving tong pinza servir pince à servir

| REF | (cm) | | |
|------------|------------|--|--------|
| 0433870702 | 19x7.5x4.5 | | 01/144 |



PINÇA P/SERVIR

serving tong pinza servir pince à servir

| REF | (cm) | | |
|------------|------|--|--------|
| 0433940661 | 25 | | 12/120 |



PINÇA P/SERVIR

serving tong pinza servir pince à servir

| REF | (cm) | | |
|------------|----------|--|--------|
| 0430756054 | 20.5x4.5 | | 24/064 |



PINÇA P/SERVIR

serving tong pinza servir pince à servir

| REF | (cm) | | |
|------------|------|--|--------|
| 0433940666 | 22 | | 12/120 |



PINÇA P/SERVIR

serving tong pinza servir pince à servir

| REF | (cm) | | |
|------------|------|--|--------|
| 0431260052 | 22 | | 12/144 |



PINÇA P/SERVIR

serving tong pinza servir pince à servir

| REF | (cm) | | |
|------------|------|--|--------|
| 0433940692 | 22 | | 12/120 |



PINÇA P/SALADA

salad tong pinza ensalada pince à salade

| REF | (cm) | | |
|------------|------|--|--------|
| 0433940107 | 25 | | 12/120 |



PINÇA P/SALADA

salad tong pinza ensalada pince à salade

| REF | (cm) | | |
|------------|------|--|--------|
| 0433652701 | 24 | | 01/100 |



PINÇA P/SALADA
salad tong pinza ensalada pince à salade

| REF | (cm) | |
|------------|------|--------|
| 0433652730 | 24 | 01/100 |



PINÇA P/PÃO
bread tong pinza para pan pince à pain

| REF | (cm) | |
|------------|------|--------|
| 0433940696 | 22 | 12/120 |



PINÇA P/ESPARGUETE
spaguetti tong pinza para pasta pince à spaghetti

| REF | (cm) | |
|------------|------|--------|
| 0433496002 | 18 | 12/120 |



PINÇA P/ESPARGUETE
spaguetti tong pinza para pasta pince à spaghetti

| REF | (cm) | |
|------------|------|--------|
| 0430972819 | 22 | 06/072 |



PINÇA P/ESPARGUETE
spaguetti tong pinza para pasta pince à spaghetti

| REF | (cm) | |
|------------|------|--------|
| 0433870041 | 24x4 | 01/020 |



PINÇA P/HAMBURGUER
hamburguer tong
pinza para hamburguesa
pince pour hamburger



| REF | (cm) | |
|-------------|-----------|--------|
| 04307544112 | 10.7x24.2 | 12/072 |



PINÇA P/FRITOS
serving tong pinza servir pince à servir



| REF | (cm) | |
|------------|--------|--------|
| 0432276575 | 7x28.5 | 01/048 |



PINÇA CHEF
barbecue tong pinza para barbaçoa pince à barbecue

| REF | (cm) | |
|------------|------|--------|
| 0432330080 | 25 | 01/001 |
| 0432330081 | 30 | 01/001 |
| 0432330040 | 40 | 01/001 |



PINÇA P/CHURRASCO
barbecue tong pinza para barbaçoa pince à barbecue

| REF | (cm) | |
|------------|------|--------|
| 0434078112 | 30 | 01/240 |
| 0434078116 | 40 | 01/120 |



PINÇA JUMBO
tong pinza pince

| REF | (cm) | |
|------------|------|--------|
| 0434070912 | 35 | 01/500 |



PINÇA P/CHURRASCO
barbecue tong pinza para barbaçoa pince à barbecue

| REF | (cm) | |
|------------|------|--------|
| 0430681012 | 30.5 | 12/144 |



INOX

PINÇA P/CHURRASCO
barbecue tong pinza para barbaça pince à barbecue

| REF | (cm) | |
|-------------|------|--------|
| 04312600129 | 30 | 01/012 |



INOX VINIL vinyl

PINÇA P/CHURRASCO
barbecue tong pinza para barbaça pince à barbecue

| REF | (cm) | |
|-------------|------|--------|
| 04307544105 | 30.5 | 24/072 |
| 0433653871 | 40 | 01/108 |



INOX VINIL vinyl

PINÇA P/CHURRASCO
barbecue tong pinza para barbaça pince à barbecue

| REF | (cm) | |
|------------|------|--------|
| 0432430012 | 30 | 01/060 |



INOX Si silicone

PINÇA P/CHURRASCO
barbecue tong pinza para barbaça pince à barbecue

| REF | (cm) | |
|-------------|------|--------|
| 04306810012 | 25 | 12/144 |



**+ 240°
- 40°**

INOX Si silicone

PINÇA P/CHURRASCO
barbecue tong pinza para barbaça pince à barbecue

| REF | (cm) | |
|------------|------|--------|
| 0433870710 | 37 | 01/072 |
| 0432276574 | 39 | 12/048 |



INOX

TENAZ P/GRELHADOS
tong for grills pinza para la parrilla pince pour grillades

| REF | (cm) | |
|------------|------|--------|
| 0432435045 | 36 | 00/048 |



INOX

TENAZ P/GRELHADOS
tong for grills pinza para la parrilla pince pour grillades

| REF | (cm) | |
|------------|------|--------|
| 0432435048 | 50 | 00/048 |

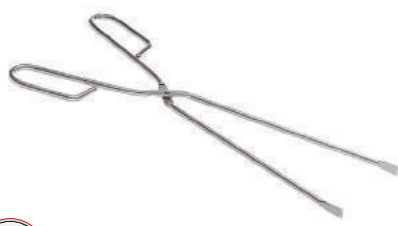

INOX

TENAZ P/GRELHADOS
tong for grills pinza para la parrilla pince pour grillades

| REF | (cm) | |
|------------|------|--------|
| 0432000301 | 30 | 01/120 |



APRESENTAÇÃO
presentation
presentación
présentation

pg. 219





INOX

ESPÁTULA
spatula espátula spatule

| REF | (cm) | |
|------------|----------|--------|
| 0432790043 | 27.5x7.5 | 03/100 |



INOX NYLON

ESPÁTULA
spatula espátula spatule

| REF | (cm) | |
|------------|------|--------|
| 0433657725 | 25x6 | 01/096 |
| 0433657729 | 29x7 | 01/060 |



INOX PP

ESPÁTULA
spatula espátula spatule

| REF | (cm) | |
|------------|------|--------|
| 0430721124 | 25x6 | 12/120 |



INOX PP

ESPÁTULA
spatula espátula spatule

| REF | (cm) | |
|------------|----------|--------|
| 0430687728 | 34.5x7.5 | 06/012 |
| 0430687721 | 39x10.5 | 06/036 |

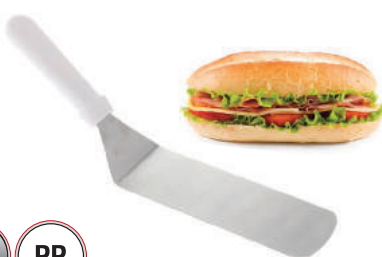

INOX PP

ESPÁTULA
spatula espátula spatule

| REF | (cm) | |
|------------|--------|--------|
| 0430687723 | 37x7.5 | 12/120 |



INOX PP

ESPÁTULA PERFORADA
perforated spatula espátula perforada spatule perforée

| REF | (cm) | |
|------------|--------|--------|
| 0430721142 | 38x7.5 | 12/120 |



INOX

ESPÁTULA
spatula espátula spatule

| REF | (cm) | |
|-------------|------|--------|
| 04312600094 | 28x9 | 12/050 |



INOX

ESPÁTULA
spatula espátula spatule

| REF | (cm) | |
|------------|--------|--------|
| 0430721111 | 30x7.5 | 12/120 |



INOX

ESPÁTULA
spatula espátula spatule

| REF | (cm) | |
|-------------|--------|--------|
| 04312600099 | 25x2.5 | 01/120 |
| 0430723004 | 11.4 | 01/120 |



INOX

ESPÁTULA
spatula espátula spatule

| REF | (cm) | |
|-------------|------|--------|
| 04312600058 | 14x6 | 01/144 |



INOX Si silicone

ESPÁTULA
spatula espátula spatule

| REF | (cm) | |
|------------|----------|--------|
| 0730750165 | 36.5x9.2 | 12/072 |



INOX PP

ESPÁTULA P/FRITOS
spatula espátula spatule

| REF | (cm) | |
|-------------|----------|--------|
| 04307544601 | 28.5x7.5 | 24/048 |

**UTENSÍLIOS COZINHA**

kitchen utensils utensilios cocina ustensiles cuisine

**INOX****ESPÁTULA P/FRITOS**
spatula espátula spatule

| REF | (cm) | |
|------------|----------|--------|
| 0433870055 | 29xØ10.3 | 01/025 |

**INOX ABS****ESPÁTULA P/MANTEIGA**
spatula espátula spatule

| REF | (cm) | |
|------------|--------|--------|
| 0431260045 | 23x3.5 | 12/240 |

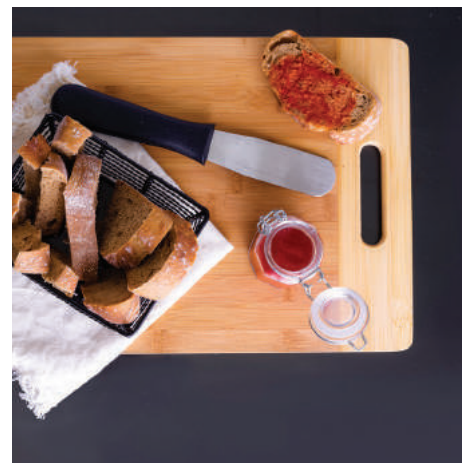
**INOX ABS****ESPÁTULA P/SANDES**
spatula espátula spatule

| REF | (cm) | |
|-------------|------|--------|
| 04312600073 | 18x3 | 12/240 |

**INOX PP****GARFO P/TRINCHAR**
cook's fork tenedor de trinchar fouchette de chef

| REF | (cm) | |
|------------|------|--------|
| 0430721112 | 30.5 | 12/240 |

**PP****ESPÁTULA**
spatula espátula spatule

| REF | (cm) | |
|------------|-------|--------|
| 0733341105 | 25x10 | 01/012 |

**INOX NYLON****RASPADOR**
scraper rasqueta raclette

| REF | (cm) | |
|------------|------|--------|
| 0433657508 | 26x8 | 01/060 |

**INOX PLÁSTICO**
plastic**RASPADOR**
scraper rasqueta raclette

| REF | (cm) | |
|-------------|---------|--------|
| 04312600069 | 25.8x15 | 01/120 |

**INOX PP****RASPADOR P**
spatula espátula spatule

| REF | (cm) | |
|-------------|---------|--------|
| 04327900141 | 25x10.2 | 12/120 |

**INOX****RASPADOR**
scraper rasqueta raclette

| REF | (cm) | |
|-------------|---------|--------|
| 04312690062 | 21x14.5 | 01/144 |

**UTENSÍLIOS PASTELARIA**
pastry utensils
utensilios pastelería
ustensiles pâtisserie**pg. 83**



INOX

PORTA TALHERES

cutlery holder contenedor de cubiertos panier à couverts

| REF | (cm) | |
|------------|------------|--------|
| 0432790221 | Ø12.7x14.9 | 04/036 |



INOX

PORTA TALHERES

cutlery holder contenedor de cubiertos panier à couverts

| REF | (cm) | |
|------------|---------|--------|
| 0434070033 | Ø9x16.3 | 01/072 |



INOX

PORTA TALHERES

cutlery holder contenedor de cubiertos panier à couverts

| REF | (cm) | |
|-------------|---------|--------|
| 04312690031 | Ø9.5x13 | 01/012 |



INOX

PORTA TALHERES

cutlery holder contenedor de cubiertos panier à couverts

| REF | (cm) | |
|------------|------------|--------|
| 0433655111 | Ø11.5x13.5 | 01/072 |



1



2

PLÁSTICO
plastic**PORTA TALHERES**

cutlery holder contenedor de cubiertos panier à couverts

| REF | (cm) | |
|------------|----------|--------|
| 0430681307 | 1 011x14 | 06/060 |
| 0733610227 | 2 011x14 | 06/144 |



1



2

PLÁSTICO
plastic**PORTA TALHERES**

cutlery holder contenedor de cubiertos panier à couverts

| REF | (cm) | |
|------------|----------------|--------|
| 0430721600 | 1 10.7x10.7x14 | 01/012 |
| 0732960214 | 2 12.7x12.7x15 | 01/036 |



PP

TABULEIRO P/TALHERES

cutlery tray bandeja de cubiertos plateau à couverts

| REF | (cm) | |
|------------|---------|--------|
| 0730260004 | 52x29x9 | 01/012 |



PP

TABULEIRO P/TALHERES

cutlery tray bandeja de cubiertos plateau à couverts

| REF | (cm) | |
|------------|---------|--------|
| 0733610039 | 55x36x9 | 01/010 |



PP

TABULEIRO GN P/TALHERES

cutlery tray bandeja de cubiertos plateau à couverts

| REF | (cm) | |
|------------|------------|--------|
| 0732960216 | 53x32.5x10 | 01/022 |



PP

PORTA TALHERES

cutlery holder contenedor de cubiertos panier à couverts

| REF | (cm) | |
|------------|--------------|--------|
| 0732960211 | 41.5x21.4x15 | 01/015 |



PP

CAIXA MULTIFUNÇÕES

multifunction box caja multifuncional boitier multifonctions

| REF | (cm) | |
|------------|------------|--------|
| 0732960223 | 29x17x11.5 | 01/024 |

APRESENTAÇÃO
presentation
présentation

pg. 218/221





UTENSÍLIOS COZINHA

kitchen utensils utensilios cocina ustensiles cuisine

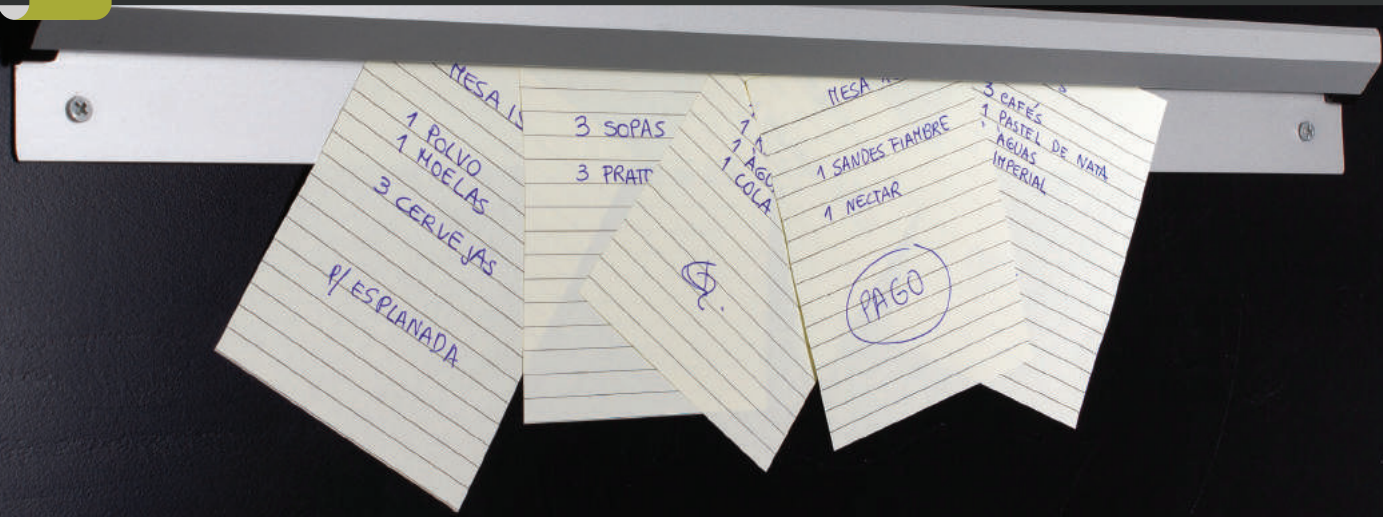

AL

BARRA P/PEDIDOS
check minder barra de notas barre porte-bons

| REF | (cm) | |
|-------------|----------|--------|
| 0433658061 | 1 61x5.3 | 01/035 |
| 07336100152 | 2 61x6 | 01/024 |
| 0431260024 | 3 61x6 | 02/024 |

espetos espalmados
flat skewers
pinchos aplanados
brochettes évasées



INOX **PACK 12**

ESPETOS C/ARGOLA
skewers set conjunto pinchos set brochettes

| REF | (cm) | |
|------------|------|------------------------|
| 0433655230 | 30 | 01/100 |
| 0433655235 | 35 | 01/100 |
| 0433655240 | 40 | 1 PACK 6 01/100 |



PACK 12

INOX

ESPETOS C/FLOR DE LIS
skewer set conjunto pinchos set brochette

| REF | (cm) | |
|-------------|------|--------|
| 04312600019 | 25 | 12/300 |



PACK 12

INOX

ESPETOS C/ESPADA
skewer set conjunto pinchos set brochette

| REF | (cm) | |
|-------------|------|--------|
| 04312600057 | 25 | 12/300 |



INOX

GANCHOS
hooks ganchos crochets

| REF | (cm) | |
|------------|------|--------|
| 0433657514 | 14 | 01/126 |



INOX

GANCHOS DUPLOS
hooks ganchos crochets

| REF | (cm) | |
|------------|------|--------|
| 0430688902 | 32 | 10/180 |



UTENSÍLIOS SERVIR
serving utensils
utensilios para servir
ustensiles de service

pg. 180/181





UTENSÍLIOS PREPARAÇÃO

preparation utensils utensilios preparacion *utensiles préparation*



UTENSÍLIOS PREPARAÇÃO

preparation utensils utensilios preparacion ustensiles préparation



INOX

MOLDE OVO
mould egg molde huevo moule à oeufs

| REF | (cm) | |
|-------------|-----------|--------|
| 04312600095 | 1 Ø9 | 01/300 |
| 04312600851 | 2 8.5x8.5 | 01/300 |



INOX

PÁ
shovel librador pelle à glace

| REF | (cm) | |
|------------|-----------|--------|
| 0432790182 | 42.5x18.2 | 12/036 |



INOX

CORREDOR
shovel librador pelle à farine

| REF | (cm) | LT | |
|-------------|----------|-----|--------|
| 04312600011 | Ø10x37.5 | 0.8 | 02/024 |



INOX

CORREDOR
shovel librador pelle à farine

| REF | (cm) | LT | |
|-------------|----------|-----|--------|
| 04312600034 | Ø7x12.5 | 0.3 | 00/072 |
| 04312600047 | Ø11.5x31 | 1.8 | 01/036 |



INOX

JARRO
jug jarra pot

| REF | (cm) | LT | |
|------------|------------|-----|--------|
| 0432430064 | Ø10.2x25.5 | 1.5 | 01/024 |



INOX

JARRO
jug jarra pot

| REF | (cm) | LT | |
|-------------|------------|-----|--------|
| 0433890243 | Ø13.2x16.3 | 1.5 | 01/024 |
| 04338902431 | Ø14.2x16.7 | 2 | 01/024 |

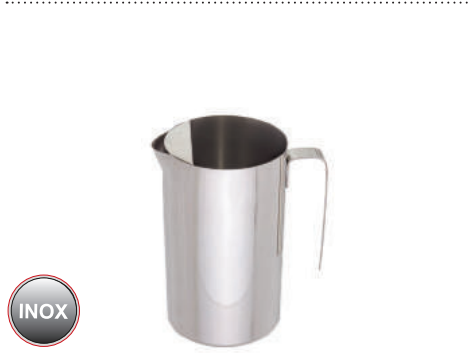

INOX

JARRO
jug jarra pot

| REF | (cm) | LT | |
|------------|----------|-----|--------|
| 0432790038 | Ø11x18.5 | 1.7 | 05/048 |

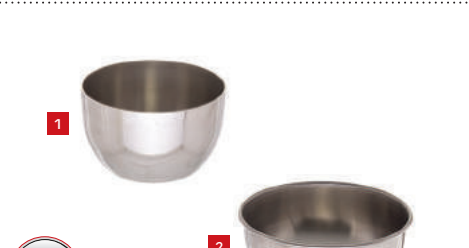

INOX

TIGELA
bowl bol bol

| REF | (cm) | |
|------------|----------|--------|
| 0432790055 | 1 Ø8x5 | 04/144 |
| 0432790048 | 2 Ø9.5x4 | 10/144 |



INOX

TIGELA
bowl bol bol

| REF | (cm) | |
|-------------|---------|--------|
| 04309712021 | Ø15.5x9 | 01/036 |



TIGELA C/PEGA
bowl bol bol

| REF | (cm) | |
|-------------|----------|--------|
| 0430971223 | Ø16x10 | 12/048 |
| 04309712231 | Ø19x11.5 | 12/048 |
| 04309712232 | Ø25x14 | 06/012 |



SALADEIRA
salad bowl ensaladera saladier

| REF | (cm) | |
|------------|------------|--------|
| 0432790016 | Ø16.7x6.5 | 06/024 |
| 0432790020 | Ø20.9x10 | 06/024 |
| 0432790025 | Ø25.7x11.2 | 06/024 |
| 0432790030 | Ø31x12.3 | 06/024 |



TIGELA
bowl bol bol

| REF | (cm) | |
|------------|---------|--------|
| 0432430075 | Ø7x14 | 01/048 |
| 0432430150 | Ø8.5x18 | 01/036 |
| 0432431200 | Ø17x35 | 01/018 |
| 0432431600 | Ø18x38 | 01/012 |
| 0432432000 | Ø19x43 | 01/012 |



TIGELA
bowl bol bol

| REF | (cm) | |
|-------------|--------|--------|
| 04324303001 | Ø22x11 | 01/036 |
| 04324305001 | Ø26x13 | 01/024 |

base antiderrapante em silicone **non-slip silicone base**
base de silicona antideslizante base de silicone anti-dérapant



SALADEIRA
salad bowl ensaladera saladier

| REF | (cm) | |
|-------------|---------|--------|
| 0430971231 | Ø28x7.5 | 01/012 |
| 04309712311 | Ø30x9.5 | 01/012 |



SALADEIRA
salad bowl ensaladera saladier

| REF | (cm) | |
|------------|----------|--------|
| 0433495027 | Ø36x10 | 01/100 |
| 0433495029 | Ø40x10.5 | 01/080 |



ALGUIDAR
bowl bol bol

| REF | (cm) | |
|-------------|----------|--------|
| 0432430034 | Ø34x12.5 | 00/040 |
| 04312600106 | Ø48x15 | 06/012 |



LEGUMEIRA
vegetable dish legumbrera legumiere

| REF | (cm) | |
|------------|---------|--------|
| 0433658015 | Ø15x4.3 | 01/030 |



UTENSÍLIOS PREPARAÇÃO

preparation utensils utensilios preparacion ustensiles préparation



CESTO P/COZER

basket for cooking cesto para cocinar panier pour la cuisson

| REF | (cm) | |
|------------|----------|--------|
| 0431260770 | 17x17x26 | 06/012 |



CESTO P/COZER MASSA

basket for cooking pasta cesto para cocinar pasta panier pour la cuisson de pasta

| REF | (cm) | |
|-------------|--------|--------|
| 04312600224 | Ø22x13 | 01/012 |



FRITEIRA C/CESTO INOX

frying freidora friteuse

| REF | (cm) | |
|------------|----------|--------|
| 0433780853 | Ø30x11.3 | 00/120 |



ESCORREDOR P/FRITOS

fry colander escurrefritos passoire à friture

| REF | (cm) | |
|------------|----------|--------|
| 0433980040 | Ø40x17.2 | 01/001 |



ESCORREDOR P/FRITOS

fry colander escurrefritos passoire à friture

| REF | (cm) | |
|------------|---------|--------|
| 0433840030 | Ø30x5.5 | 01/006 |
| 0433840034 | Ø34x5.5 | 01/006 |



PÁ P/FRITOS

fries spoon pala de fritos pelle à frit

| REF | (cm) | |
|------------|-----------|--------|
| 0430722810 | 28x10x4.5 | 01/072 |



CESTO P/TACOS

basket for tacos cesto para tacos panier pour tacos

| REF | (cm) | |
|------------|------|--------|
| 0733610122 | 45.7 | 01/012 |



NINHO DE ARAME

wire strainer nido de alambre moule à nid d'oiseau

| REF | (cm) | |
|------------|---------------|--------|
| 0430682511 | Ø8 Ø10x38.5 | 01/150 |



PÁ P/BATATAS FRITAS

fries spoon pala de patatas fritas pelle à friture

| REF | (cm) | |
|------------|---------------|--------|
| 0430720090 | 22.7x20.5x4.5 | 01/024 |

CENTRIFUGADORAS

spinner
centrifugadora
essoreuse

Prática e fácil de utilizar
Remove a água acumulada na lavagem

Practical and easy to use
Removes the water accumulated in the wash

Práctica y fácil de utilizar
Quitta el agua en el lavado

Pratique et facile à utiliser
Retirer l'eau accumulé dans le lavage



CENTRIFUGADORA (SALADAS)
spinner centrifugadora essoreuse

| REF | (cm) | LT | |
|-------------|----------|------|--------|
| 07302600191 | Ø46x56.5 | 18.9 | 01/001 |



CENTRIFUGADORA (SALADAS)
spinner centrifugadora essoreuse

| REF | (cm) | LT | |
|------------|--------|-----|--------|
| 0730260095 | Ø35x47 | 9.5 | 01/001 |



ESCORREDOR
colander escurridera passoire

| REF | (cm) | LT | |
|------------|-----------|-----|--------|
| 0732960742 | 26x35.5x9 | 9.5 | 01/024 |



ESCORREDOR
colander escurridera passoire

| REF | (cm) | LT | |
|------------|----------|-----|--------|
| 0732960738 | Ø35x12.5 | 9.5 | 01/024 |



ESCORREDOR
colander escurridera passoire

| REF | (cm) | |
|------------|----------|--------|
| 0431260032 | Ø32x20 | 01/012 |
| 0431260040 | Ø40x14.5 | 01/012 |



ESCORREDOR
colander escurridera passoire

| REF | (cm) | |
|------------|------|--------|
| 0430971137 | Ø20 | 01/012 |



COADOR CHINÊS
chinese sieve colador chino passoire chinois

| REF | (cm) | |
|-------------|------|--------|
| 04327900171 | Ø17 | 10/024 |
| 04327900262 | Ø26 | 17/024 |



COADOR CHINÊS
chinese sieve colador chino passoire chinois

| REF | (cm) | |
|------------|------|--------|
| 0433656320 | Ø20 | 01/040 |
| 0433656322 | Ø22 | 01/040 |
| 0433656324 | Ø24 | 01/040 |



UTENSÍLIOS PREPARAÇÃO

preparation utensils utensilios preparacion ustensiles préparation



COADOR CHINÊS

chinese sieve colador chino passoire chinois

| REF | (cm) | |
|-------------|------|--------|
| 0431260020 | Ø20 | 01/012 |
| 04312600241 | Ø24 | 01/012 |



COADOR REDE C/PROTEÇÃO

sieve colador passoire

| REF | (cm) | |
|-------------|------|--------|
| 04312600225 | Ø22 | 01/012 |



COADOR CÔNICO

conical sieve colador cónico passoire conique

| REF | (cm) | |
|----------------------|------|--------|
| 04327900071 1 | Ø7 | 02/288 |
| 04327900102 | Ø10 | 04/144 |
| 04312690124 2 | Ø12 | 01/072 |
| 04336572161 3 | Ø16 | 01/060 |



COADOR

sieve colador passoire

| REF | (cm) | |
|------------|------|--------|
| 0433657408 | Ø8.5 | 12/084 |



COADOR

sieve colador passoire

| REF | (cm) | |
|-------------|-------|--------|
| 0432270008 | Ø11.5 | 01/100 |
| 0432270006 | Ø14 | 01/050 |
| 04322700032 | Ø20 | 01/050 |



COADOR

sieve colador passoire

| REF | (cm) | |
|----------------------|------|--------|
| 04307220121 1 | Ø30 | 06/012 |
| 0430680541 2 | Ø26 | 01/012 |
| 0430680542 | Ø30 | 01/012 |
| 0430680544 | Ø36 | 01/012 |

com malha em rede dupla with double wire
con malla de red doble avec maille à filet double



COADOR

sieve colador passoire

| REF | (cm) | |
|---------------------|------|--------|
| 0433657108 1 | Ø8 | 01/144 |
| 0433657110 | Ø10 | 01/144 |
| 0433657112 | Ø12 | 01/144 |
| 0433657116 | Ø16 | 01/120 |
| 0433657118 | Ø18 | 01/120 |
| 0433657120 | Ø20 | 01/120 |
| 0430680116 2 | Ø20 | 01/050 |
| 0433657122 3 | Ø20 | 01/001 |

NOVO
new



FUNIL C/FILTRO

funnel with filter embudo con filtro entonnoir à filtre

| REF | (cm) | |
|----------------------|--------------|--------|
| 0433518191 1 | Ø10 A | 12/048 |
| 04320000141 | Ø14 B | 01/024 |
| 0430683002 | Ø14 C | 12/072 |
| 04336572201 2 | Ø20 | 01/038 |

A filtro grosso thick filter filtro grueso filtre grossier
B filtro fino thin filter filtro fino filtre fin
C filtro grosso thick filter filtro grueso filtre grossier



GARRAFA P/MOLHOS

bottle botella bouteille

| REF | (cm) | | ML | |
|-------------|---------|--|-----|--------|
| 07302602404 | Ø5x18 | | 240 | 01/240 |
| 07302602403 | Ø5x18 | | 240 | 01/240 |
| 07302602402 | Ø5x18 | | 240 | 01/240 |
| 07302603503 | Ø5.5x20 | | 350 | 01/240 |
| 07302603502 | Ø5.5x20 | | 350 | 01/240 |
| 07302603501 | Ø5.5x20 | | 350 | 01/240 |
| 07302607002 | Ø7x24 | | 240 | 01/240 |
| 07302607001 | Ø7x24 | | 700 | 01/240 |



GARRAFA P/MOLHOS

bottle botella bouteille

| REF | (cm) | ML | |
|------------|---------|-----|--------|
| 0733610103 | Ø5x18 | 470 | 01/240 |
| 0733610104 | Ø5x18 | 700 | 01/240 |
| 0733610105 | Ø5.5x20 | 950 | 01/240 |



GARRAFA P/MOLHOS

bottle botella bouteille

| REF | (cm) | ML | |
|------------|---------|-----|---------|
| 0732304122 | Ø6x20.5 | 350 | 01/500 |
| 0732304123 | Ø6.7x20 | 500 | 01/1000 |
| 0732304124 | Ø6.7x26 | 700 | 01/1000 |



SUPOORTE P/FRASCOS MOLHOS

bottle holder soportes para botellas porte-bouteille

| REF | (cm) | ML | |
|--------------|----------|-----|--------|
| 0431265731 * | 23x8.5x8 | 350 | 01/040 |
| 0431267231** | 23x8.5x8 | 500 | 01/024 |



* ø5.7cm frascos bottles botellas bouteilles
** ø7.2cm frascos bottles botellas bouteilles



SERINGA P/MOLHOS

syringe for sauces jeringa para salsas seringue pour sauces

| REF | (cm) | |
|------------|----------|--------|
| 0433871191 | 16.5x9x5 | 01/050 |

caixa incluída **box included** caja incluida boîte inclus

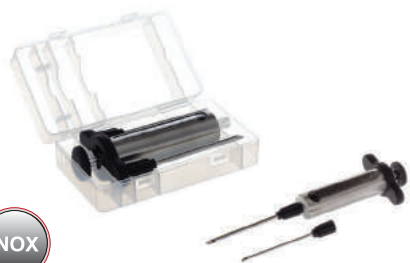

PASSE-VITE C/3 DISCOS

potato mashing machine with 3 discs
passapurés con 3 discos
presse-purée avec 3 disques

| REF | (cm) | |
|---------------------|------|--------|
| 0438302226 1 | Ø26 | 01/001 |
| 0438302232 | Ø32 | 01/001 |
| 0431473584 2 | Ø20 | 01/006 |



ESMAGADOR BATATA

potato press prensa patatas presse-pomme de terre

| REF | (cm) | |
|------------|------------|--------|
| 0432790050 | 44x12.8x14 | 06/012 |



ESMAGADOR BATATA C/2 DISCOS

potato press with 2 discs
prensa patatas con 2 discos
presse-pomme de terre avec 2 disques

| REF | (cm) | |
|------------|----------------|--------|
| 0433651804 | 28x9 Ø9 (2x) | 01/010 |





UTENSÍLIOS PREPARAÇÃO

preparation utensils utensilios preparacion ustensiles préparation



ESMAGADOR BATATA
potato press prensa patatas presse-pomme de terre

| REF | (cm) | |
|-------------|------|--------|
| 04312600148 | 36 | 01/024 |



ESMAGADOR BATATA
potato press prensa patatas presse-pomme de terre

| REF | (cm) | |
|------------|------|--------|
| 0433518179 | 25 | 06/024 |



ESMAGADOR ALHOS
garlic press prensa ajos presse-ali

| REF | (cm) | |
|------------|----------|--------|
| 0433518143 | 19x2.5x6 | 12/024 |



ESMAGADOR ALHOS + DESCAROÇADOR
garlic press + core
prensa ajos+ descorazonador
presse-ali + videur

| REF | (cm) | |
|------------|------|--------|
| 0432291008 | 16.5 | 01/144 |



MOLDE RISSÓIS
dumpling mould molde empanadillas moule à chaussons

| REF | (cm) | |
|-------------|------|--------|
| 04307544061 | Ø9 | 24/072 |



MOLDADOR HAMBURGUER
hamburger maker
moldeador hamburguesa
mouleur hamburgerer

| REF | (cm) | |
|------------|---------|--------|
| 0733880816 | Ø9.5x12 | 01/036 |



MOLDADOR HAMBURGUER
hamburger maker
moldeador hamburguesa
mouleur hamburgerer

| REF | (cm) | |
|------------|-------|--------|
| 0432290002 | Ø11x2 | 01/040 |



MARTELO
hammer martillo attendrisseurs à viande

| REF | (cm) | |
|-------------|------------|--------|
| 04306813902 | 25 600gr | 02/012 |



MARTELO
hammer martillo attendrisseurs à viande

| REF | (cm) | |
|------------|--------------|--------|
| 0432276114 | 26x6 440gr | 01/036 |

mármore natural natural marble
mármol natural marbre naturel



MARTELO
hammer martillo attendrisseurs à viande

| REF | (cm) | |
|------------|-----------|--------|
| 0733341012 | 29x11.3x6 | 00/001 |



ALMOFARIZ
mortar and pestle mortero con mano mortier avec pilon

| REF | (cm) | |
|------------|-------|--------|
| 0433690010 | Ø14x8 | 01/004 |

mármore natural natural marble
mármol natural marbre naturel



ALMOFARIZ
mortar and pestle mortero con mano mortier avec pilon

| REF | (cm) | |
|------------|--------|--------|
| 0433690011 | Ø12x10 | 01/006 |





ALMOFARIZ
mortar and pestle mortero con mano mortier avec pilon

| REF | (cm) | |
|-------------|----------|--------|
| 04306810022 | Ø11.7x10 | 01/024 |



ALMOFARIZ
mortar and pestle mortero con mano mortier avec pilon

| REF | (cm) | |
|------------|--------|--------|
| 0733341026 | Ø10x8 | 06/012 |
| 0733341027 | Ø13x10 | 06/012 |



ALMOFARIZ
mortar and pestle mortero con mano mortier avec pilon

| REF | (cm) | |
|---------------------|-------|--------|
| 0210153703 1 | Ø9x6 | 02/036 |
| 0220010674 2 | Ø14x8 | 01/024 |



ESPRESSADOR CITRINOS
citrus squeezer exprimidor para citricos presse-citron

| REF | (cm) | |
|------------|------------|--------|
| 0432276120 | 29x16.5x41 | 01/002 |



ESPRESSADOR CITRINOS
citrus squeezer exprimidor para citricos presse-citron

| REF | (cm) | |
|------------|------|--------|
| 0430753024 | - | 01/012 |

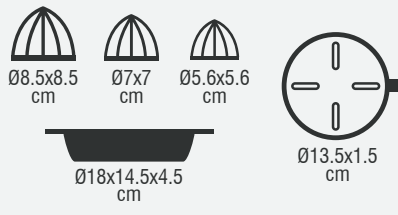

ESPRESSADOR CITRINOS
citrus squeezer exprimidor para citricos presse-citron

| REF | (cm) | |
|---------------------|---------|--------|
| 0432790007 1 | Ø7x19.5 | 04/048 |
| 0431260003 2 | 10.5x16 | 12/144 |



ESPRESSADOR CITRINOS
citrus squeezer exprimidor para citricos presse-citron

| REF | (cm) | |
|-------------|----------|--------|
| 04306820011 | 13x7x1.7 | 48/144 |



ESPRESSADOR LIMÃO
lemon squeezer exprimidor limón presse-citron

| REF | (cm) | |
|------------|--------|--------|
| 0733597068 | 14x4.5 | 00/001 |



ESPRESSADOR LIMÃO
lemon squeezer exprimidor limón presse-citron

| REF | (cm) | |
|------------|--------|--------|
| 0733341011 | 11x4.5 | 00/001 |



ESPRESSADOR LIMÃO
lemon squeezer exprimidor limón presse-citron

| REF | (cm) | |
|---------------------|-------|--------|
| 0432276126 1 | Ø6x20 | 01/036 |
| 0432270000 2 | Ø9x23 | 01/024 |

**UTENSÍLIOS PREPARAÇÃO**

preparation utensils utensilios preparacion ustensiles préparation

**BALANÇA DIGITAL**

digital balance balanza digital balance numérique

| REF | (cm) | KG | |
|------------|---------|----|--------|
| 0432270002 | 15.5x22 | 8 | 01/020 |

**BALANÇA MECÂNICA**

mechanical balance balanza mecánica balance mécanique

| REF | (cm) | KG | |
|------------|------------|----|--------|
| 0432272001 | 21x21x25.5 | 10 | 01/006 |

**ISQUEIRO A GÁS**

gas lighter encendedor de gas allume-gaz à flamme

| REF | (cm) | |
|------------|------|-------|
| 0931570019 | 36 | 12/96 |

**TEMPORIZADOR**

timer temporizador minuteur

| REF | (cm) | |
|------------|--------|--------|
| 0432270306 | Ø6x7.5 | 01/100 |

**TERM. DIGITAL INFRAVERMELHOS/LASER**digital thermometer
termómetro digital
thermomètre numérique

| REF | TEMPERATURA temperature temperatura temperature | |
|------------|--|--------|
| 0432270320 | -50°C~380°C | 01/060 |

**TERMÓMETRO DIGITAL**digital thermometer
termómetro digital
thermomètre numérique

| REF | TEMPERATURA temperature temperatura temperature | |
|------------|--|--------|
| 0432271149 | -50°C~300°C | 06/072 |

**TERMÓMETRO DIGITAL**digital thermometer
termómetro digital
thermomètre numérique

| REF | TEMPERATURA temperature temperatura temperature | |
|------------|--|--------|
| 0432271151 | -50°C~300°C | 06/072 |

**TERMÓMETRO REFRIGERADOR C/BASE**refrigerator thermometer
termómetro refrigerador
thermomètre

| REF | TEMPERATURA temperature temperatura temperature | |
|------------|--|--------|
| 0432270016 | -30°C~30°C | 06/072 |

**TERMÓMETRO FORNO C/BASE**oven thermometer
termómetro para horno
thermomètre pour four

| REF | TEMPERATURA temperature temperatura temperature | |
|------------|--|--------|
| 0430720301 | 50°C~300°C | 01/200 |

**TERMÓMETRO AÇÚCAR**thermometer sugar
termómetro de azúcar
thermomètre à sucre

| REF | TEMPERATURA temperature temperatura temperature | |
|------------|--|--------|
| 0432271155 | -50°C~200°C | 06/072 |

| TEMPERATURA temperaturef temperatura température | | | |
|--|-----|-----|--|
| produto product producto produit | °C | °F | feste test prueba tester |
| xaropes/rebuçados syrups/sweets jarabes/pastillas sirops/pastilles | - | - | - |
| geleia jelly jalea gelée | 104 | 220 | gotículas droplets gotitas gouttelettes |
| xarope syrups jarabes sirops | 110 | 230 | fio thread hilo fil |
| mousse/cremes mousses/creams mousses/cremas mousses/crèmes | 115 | 240 | bolinhas moles soft balls bolas suaves boules doux |
| caramelos caramel caramelos caramels | 120 | 360 | bolinhas firmes firm balls bolas firme boules fermes |
| caramelos de manteiga/marshmallows butter caramels caramelo de mantequilla caramels au beurre | 127 | 260 | bolinhas duras hard balls bolas duras boules dures |
| doce de manteiga sweet butter dulce de mantequilla doux de beurre | 138 | 280 | pequenas fendas Small splits pequenas grietas petites fissures |
| glacés/açúcar de malte glacés/malt glaseados/azúcar de malta glaçage/sucre de malt | 160 | 320 | líquido claro clear liquid líquido transparente liquide limpide |



Armazenar alimentos

store food almacenar los alimentos stocker de la nourriture

Manter os alimentos frescos e com as suas propriedades requer alguns cuidados, desde a sua escolha à forma como são armazenados. Os alimentos devidamente armazenados evitam ressecamento, murchamento e contaminação dos mesmos. No caso de alimentos de conserva, quando abertos e em caso de sobras, devem ser devidamente armazenados em recipientes limpos e com tampa.

Keeping foods fresh and with their properties requires some care, from their choice to the way they are stored. Properly stored foods prevent drying, wilting and contamination. In the case of canned foods, when opened and in case of leftovers, they should be properly stored in clean containers with a lid.

Mantener los alimentos frescos y de su propiedad requiere un poco de atención por parte de la elección de la forma en que se almacenan. Alimentos debidamente almacenados evitar el secado, el marchitamiento y la contaminación. En el caso de alimentos envasados, cuando está abierto y en caso de sobras deberá almacenarse adecuadamente en recipientes limpios con tapa.

Gardez les aliments frais et de votre propriété nécessite quelques soins de leur choix de la façon dont ils sont stockés. Aliments dûment stockés éviter le séchage, le flétrissement et la contamination. Dans le cas des conserves alimentaires lors de l'ouverture et dans le cas de déchets doivent être correctement stockés dans des contenants propres avec couvercle.



CAIXA TRANSLÚCIDA C/TAMPA COLORIDA
box caja boîte

| REF | (cm) | LT |  |
|------------|----------|----|---|
| 0730260070 | 18x18x10 | 2 | 01/060 |
| 0730260071 | 18x18x19 | 4 | 01/048 |
| 0730260072 | 22x22x19 | 6 | 01/024 |
| 0730260073 | 20x22x23 | 8 | 01/024 |
| 0730260074 | 28x28x21 | 12 | 01/012 |
| 0730260075 | 28x28x32 | 18 | 01/006 |
| 0730260076 | 28x28x40 | 22 | 01/006 |





THERMO KEEP caixa isotérmica

isothermal box caja isotérmica boîte isothermique

Leve e resistente
Fabricada em polipropileno
Isolamento e transporte de alimentos
Resistência ao choque
Pegas ergonómicas

Light and resistant
Made of polypropylene
Insulation and food transport
Shock resistance
Ergonomic handles

Ligero y resistente
Fabricada en polipropileno
Aislamiento y transporte de alimentos
Resistencia al choque
Pegas ergonómicas

Léger et résistant
En polypropylène
Isolation et transport de nourriture
Résistance aux chocs
Poignées ergonomiques



CAIXA ISOTÉRMICA THERMO KEEP
box caja boîte

| REF | (cm) | LT | |
|------------|-------|----|--------|
| 0731060002 | 60x40 | 40 | 01/001 |



CUBA P/ALIMENTOS +PÁ 940ML
container+ ladle cubeta+ pala bac+ pelle

| REF | (cm) | LT | |
|------------|--------------|-----|--------|
| 0730260081 | 74.5x33.5x71 | 81 | 01/001 |
| 0730260102 | 75x39.5x71 | 102 | 01/001 |



CUBA P/ALIMENTOS
container cubeta bac

| REF | (cm) | LT | |
|-------------|--------------|------|--------|
| 07336100431 | 55x39.6x17.8 | 24.9 | 01/012 |



TAMPA cover tapa couvercle

| REF | (cm) | |
|------------|-----------|--------|
| 0733610044 | 59x42x2.5 | 01/012 |



BALDE P/ALIMENTOS
bucket for food cubo seau

| REF | (cm) | LT | |
|-------------|---------|----|--------|
| 0733610108 | 27x25.5 | 10 | 01/010 |
| 07336101082 | 27x25.5 | 10 | 01/010 |



BALDE P/DETRITOS
bucket for debris cubo para desechos marmite à restes

| REF | (cm) | LT | |
|------------|--------|----|--------|
| 0433492932 | Ø35x35 | 21 | 00/001 |





UTENSÍLIOS CORTE

cutting utensils utensilios corte ustensiles coupe





UTENSÍLIOS CORTE

cutting utensils utensilios corte ustensiles coupe



ABS



DECORADOR MULTIUSOS
decorating tool
decorador multiuso
décorateur multi-usages

| REF | (cm) | |
|------------|---------|--------|
| 0432511070 | Ø5.3x16 | 12/072 |

1



2



NYLON **FIBRA FIBRE**

COLHER PARISIENSE
fruit baller
cuchara parisina
décorateur multi-usages

| REF | (cm) | |
|------------|--------------|--------|
| 0432514028 | 1 Ø3+Ø2.2x17 | 12/144 |
| 0432517716 | 2 Ø2.2x16 | 12/144 |

NYLON **FIBRA FIBRE**



DECORADOR (TRIÂNGULO)
decorating tool (triangle)
decorador (triângulo)
décorateur (triangle)

| REF | (cm) | |
|------------|------|--------|
| 0432517908 | 14 | 12/144 |

NYLON **FIBRA FIBRE**



FACA P/DECORAR (CORTE V)
knife (V format) cuchillo (formato V) couteau (forme en V)

| REF | (cm) | |
|------------|------|--------|
| 0432517813 | 21 | 12/144 |

NYLON **FIBRA FIBRE**



DECORADOR (CANELADO)
decorating tool (channeled)
decorador (acanalado)
décorateur (cannelée)

| REF | (cm) | |
|------------|------|--------|
| 0432517879 | 15 | 12/144 |

NYLON **FIBRA FIBRE**



FACA P/DECORAR
knife cuchillo couteau

| REF | (cm) | |
|------------|------|--------|
| 0432517916 | 19.5 | 12/144 |

NYLON **FIBRA FIBRE**



DESCAROÇADOR
core remover descarazonador videur

| REF | (cm) | |
|------------|------|--------|
| 0432517699 | 20.5 | 12/144 |



NYLON

BOLSA P/7 UTENSÍLIOS
purse for tools bolsa para utensilios poche pour ustensiles

| REF | (cm) | |
|------------|-------|--------|
| 0432510005 | 29x24 | 12/120 |

bolsa para utensilios recomendados
bag for utensils recommended
bolsa para utensilios recomendados
pochette pour ustensiles recommandés



DESCAROÇADOR
core remover descorazonador videur

| REF | (cm) | |
|------------|------------|--------|
| 0433870730 | 19.3x2.8x2 | 01/108 |



DESCAROÇADOR
core remover descorazonador videur

| REF | (cm) | |
|------------|----------|--------|
| 0430754441 | 19x4x2.2 | 12/072 |



DESCAROÇADOR
core remover descorazonador videur

| REF | (cm) | |
|------------|------|--------|
| 0432277010 | 18 | 50/100 |



DESCASCADOR
peeler pelador économe

| REF | (cm) | |
|------------|------|--------|
| 0432517867 | 17 | 12/144 |



DESCASCADOR
peeler pelador économe

| REF | (cm) | |
|------------|------|--------|
| 0432517866 | 17 | 12/144 |



DESCASCADOR
peeler pelador économe

| REF | (cm) | |
|------------|------|--------|
| 0434070002 | 21.5 | 01/600 |



DESCASCADOR
peeler pelador économe

| REF | (cm) | |
|-------------|--------|--------|
| 04307200102 | 18x8.5 | 01/120 |



DESCASCADOR MULTIFUNÇÕES
peeler pelador économe

| REF | (cm) | |
|------------|------|--------|
| 0434070045 | 18.7 | 01/480 |



DESCASCADOR
peeler pelador économe

| REF | (cm) | |
|------------|------|--------|
| 0433650807 | 11.5 | 10/100 |



DESCASCADOR
peeler pelador économe

| REF | (cm) | |
|-------------|------|--------|
| 04307200021 | 14 | 12/072 |



DESCASCADOR
peeler pelador économe

| REF | (cm) | |
|------------|------|--------|
| 0433655601 | 8x4 | 10/100 |





UTENSÍLIOS CORTE

cutting utensils utensilios corte ustensiles coupe



DESCASCADOR/CORTADOR MAÇÃ

apple cutter-peeler
cortador e pelador de manzana
couteau et éplucheur de pomme

| REF | (cm) | |
|------------|------------|--------|
| 0432276135 | 30x11x13.3 | 01/006 |

É a forma mais rápida, eficaz e económica de descascar, descaroçar e fatiar maçãs (outras frutas e legumes) em grandes quantidades e em apenas poucos minutos.

Fácil de utilizar, basta espetar a maçã no descascador e rodar manipulo. O resultado é uma maçã sem caroço e cortada em forma espiral, ideal para saladas, tartes, compotas, refeições e decoração de pratos.

A base da máquina apoia-se com firmeza sobre a mesa ou bancada, através do movimento do manipulo esta cria vácuo na base permitindo maior estabilidade. Lâminas de aço inox ajustáveis, fáceis de remover e lavar.

It is the fastest, most effective and economical way to peel, pit and slice apples (other fruits and vegetables) in large quantities and in a few minutes.

Easy to use, just stick the apple peeler in and turn knob. The result is an apple cored and cut into spiral shape, ideal for salads, pies, jam, meals and decorative plates.

The base of the machine rests firmly on a table or bench, by movement of the handle creates a vacuum on this basis allowing for greater stability. adjustable stainless steel blades are easy to remove and wash.

Es la manera más rápida, más eficaz y económica de pelar, de pozo y cortar las manzanas (otras frutas y verduras) en grandes cantidades y en unos pocos minutos.

Fácil de usar, sólo se adhieren la policia de la manzana y gire la perilla. El resultado es una manzana sin semillas y cortado en forma de espiral, ideal para ensaladas, pasteles, mermeladas, comidas y platos decorativos.

La base de la máquina se apoya firmemente sobre una mesa o un banco, por el movimiento del mango crea un vacío sobre esta base que permite una mayor estabilidad.

cuchillas de acero inoxidable ajustables son fáciles de quitar y lavar.

C'est le moyen le plus rapide, plus efficace et économique pour peler, dénoyauter et trancher les pommes (autres fruits et légumes) en grandes quantités et en quelques minutes.

Facile à utiliser, il suffit de fixer l'éplucheur de pommes et tourner le bouton. Le résultat est une pomme épépinée et coupée en forme de spirale, idéal pour les salades, les tartes, les confitures, les repas et les assiettes décoratives.

La base de la machine repose fermement sur une table, le déplacement de la poignée crée un vide sur cette base, permettant une plus grande stabilité.

Les lames en acier inoxydable réglables sont faciles à enlever et à laver.



DESCASCADOR MAÇÃ

apple cutter-peeler
cortador e pelador de manzana
couteau et éplucheur de pomme

| REF | (cm) | |
|------------|------------|--------|
| 0924270000 | 18.2x12x15 | 01/020 |

Descasca maçãs eficazmente e sem esforço.

Remove somente a pele da fruta

Equipado com pés de sucção-aperto para melhor estabilidade
Inclui 3 lâminas de corte.

Peels apples efficiently and effortlessly.

Removes fruit skin only

*Equipped with suction-grip feet for better stability
included 3 cutting blades.*

Pelar las manzanas de manera efectiva y sin esfuerzo.

Retire sólo la piel de la fruta

Equipado con pies de succión de agarre para una mejor estabilidad
3 incluye cuchillas de corte.

Pèle les pommes de façon efficace et sans effort.

Pèle seulement le fruit

*Est équipé de pieds en ventouses pour une meilleure stabilité
Contient 3 lames de coupe.*



RALADOR 4 FACES
grater rallador râpe

| REF | (cm) | |
|-------------|---------|--------|
| 04306859012 | 10x8x24 | 06/072 |

corde fino, médio, grosso e raspador
fine cut, medium, thick and scraper
corde fino, medio y grueso y raspador
coupe fine, moyenne, grosse et grattoir



RALADOR 4 FACES
grater rallador râpe

| REF | (cm) | |
|------------|-----------|--------|
| 0433877040 | 10.5x8x24 | 01/025 |

corde fino, médio, grosso e raspador
fine cut, medium, thick and scraper
corde fino, medio y grueso y raspador
coupe fine, moyenne, grosse et grattoir



RALADOR 4 FACES
grater rallador râpe

| REF | (cm) | |
|-------------|-------------|--------|
| 04322702011 | 10.5x8x23.5 | 01/072 |

corde fino, médio, grosso e rodela
fine cut, medium, thick and slices
corde fino, medio y grueso y rodajas
coupe fine, moyenne, grosse et rondelle



RALADOR 4 FACES
grater rallador râpe

| REF | (cm) | |
|------------|----------|--------|
| 0433656321 | 8.5x6x21 | 01/060 |

corde fino, médio, grosso e rodela
fine cut, medium, thick and slices
corde fino, medio y grueso y rodajas
coupe fine, moyenne, grosse et rondelle



RALADOR 4 FACES
grater rallador râpe

| REF | (cm) | |
|------------|----------|--------|
| 0432430004 | 9x6.5x21 | 01/048 |

corde fino, médio, grosso e rodela
fine cut, medium, thick and slices
corde fino, medio y grueso y rodajas
coupe fine, moyenne, grosse et rondelle



RALADOR 3 FACES
grater rallador râpe

| REF | (cm) | |
|------------|----------|--------|
| 0437413361 | 6x7x22.8 | 01/024 |

corde fino, médio e grosso
fine cut, medium and thick
corde fino, medio y grueso
coupe fine, moyenne et grosse



RALADOR
grater rallador râpe

| REF | (cm) | |
|------------|-------|--------|
| 0432430003 | 27x10 | 01/060 |



RALADOR
grater rallador râpe

| REF | (cm) | |
|---------------------|------|--------|
| 0430686112 1 | 20x6 | 24/144 |
| 0430686111 2 | 20x6 | 24/144 |
| 0430686113 3 | 20x6 | 24/144 |



1 corde fino
thin cut
corde fino
coupe fine



2 corde médio
medium cut
corde medio
coupe moyenne



3 corde grosso
thick cut
corde grueso
coupe épaisse



UTENSÍLIOS CORTE

cutting utensils utensilios corte ustensiles coupe



INOX ABS

RALADOR
grater rallador râpe

| REF | (cm) | |
|------------|--------|--------|
| 0432270101 | 24x5.8 | 25/100 |



INOX ABS

RALADOR
grater rallador râpe

| REF | (cm) | |
|------------|--------|--------|
| 0432517927 | 24x5.8 | 12/144 |



INOX PP

RALADOR
grater rallador râpe

corte fino
thin cut
corte fino
coupe fine

| REF | (cm) | |
|------------|--------|--------|
| 0433870009 | 37.5x4 | 01/010 |



INOX PP

RALADOR
grater rallador râpe

corte médio
medium cut
corte medio
coupe moyenne

| REF | (cm) | |
|------------|--------|--------|
| 0433870012 | 31x3.8 | 01/010 |



INOX PP

RALADOR
grater rallador râpe

corte grosso
thick cut
corte grueso
coupe épaisse

| REF | (cm) | |
|------------|--------|--------|
| 0433870018 | 31x7.2 | 01/010 |



INOX

RALADOR
grater rallador râpe

| REF | (cm) | |
|------------|--------|--------|
| 0433870184 | 31x3.5 | 01/010 |



INOX PP

RALADOR/LAMINADOR
grater rallador râpe



| REF | (cm) | |
|------------|------------|--------|
| 0433870048 | 23.5x5x4.3 | 01/100 |



INOX

RASPADOR D/QUEIJO
cheese slicer pala de quesos couteau à fromage

| REF | (cm) | |
|------------|--------|--------|
| 0433518175 | 20x7.5 | 12/048 |



Tambor grosso para legumes, vegetais e fruta.
Tambor fino para nozes, chocolate, pão, queijo (duro), rabanetes e, etc.
Tambor cortador para legumes, vegetais e fruta.
É ergonómico, prático e fácil de lavar.

Thick drum for vegetables, vegetables and fruit.
Fine drum for nuts, chocolate, bread, cheese (hard), radishes and etc.
Drum cutter for vegetables, vegetables and fruit.
It is ergonomic, practical and easy to wash.

Tambor de espesor de verduras, hortalizas y frutas.
Tambor bien para los frutos secos, chocolate, pan, queso (duro), rábanos y etc.
Tambor de corte de verduras, hortalizas y frutas.
Es ergonómico, práctico y fácil de lavar.

Râpe épaisse pour les légumes, les légumes et les fruits.
Râpe fine pour les noix, le chocolat, le pain, le fromage (dur), radis et etc.
Râpe de coupe pour les légumes, les légumes et les fruits.
Ergonomique, pratique et facile à laver



RALADOR MULTIUSOS

grater rallador râpe

| REF | (cm) | |
|------------|-----------------------|--------|
| 0733880351 | Ø12.5x25 Ø8x12 (3x) | 01/012 |

O ralador rotativo é a forma mais fácil e rápida para cortar alimentos.
Inclui 3 discos para ralar fino e grosso e cortar legumes, fruta, chocolate e queijo.
A estabilidade do ralador é garantida por três pés de borracha.
É ergonómico, prático e fácil de lavar.

The rotary grater is the easiest and fastest way to cut food. Includes 3 discs to grate fine, thick and cut vegetables, fruit, chocolate and cheese.
The grater stability is guaranteed for three rubber feet.
It is ergonomic, practical and easy to wash.

El rallador rotativo es la forma más fácil y rápida de cortar los alimentos.
Incluye 3 discos para rallar fino y grueso y cortar las verduras, frutas, chocolate y queso.
La estabilidad rallador está garantizado durante tres patas de goma.
Es ergonómico, práctico y fácil de lavar.

La râpe rotative est le moyen le plus simple et plus rapide pour couper les aliments.
Comprend 3 disques pour râper fin, épais et couper les légumes, les fruits, le chocolat et le fromage.
La stabilité de la râpe est garantie par trois pieds en caoutchouc.
Ergonomique, pratique et facile à laver.



RALADOR ROTATIVO

grater rallador râpe

| REF | (cm) | |
|------------|--------------------------|--------|
| 0733880830 | 28.5x18.5x24.5 Ø12(3x) | 01/012 |



CORTADOR MULTIFUNÇÕES

cutter cortador coupeur

| REF | (cm) | |
|------------|------------|--------|
| 0734040021 | 30x15x21.5 | 01/006 |





UTENSÍLIOS CORTE

cutting utensils utensilios corte ustensiles coupe

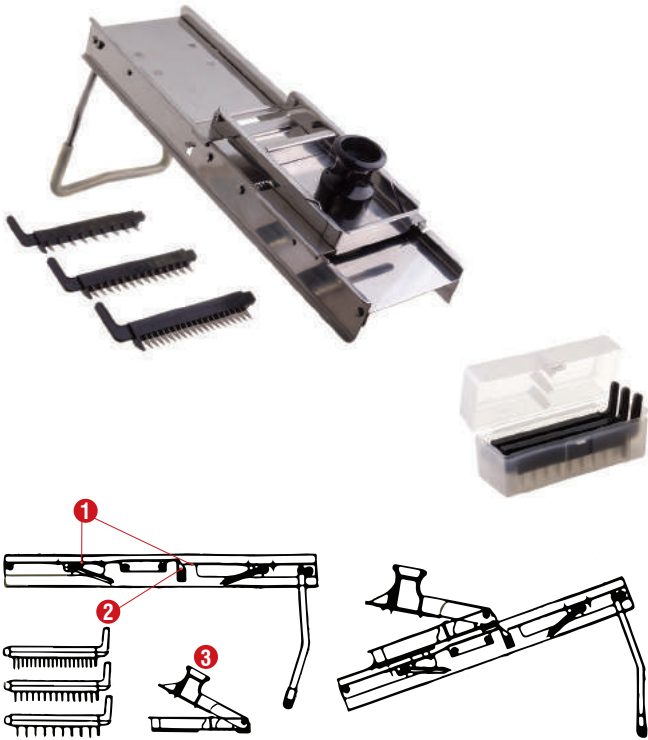

MANDOLINA 5 LÂMINAS

mandoline mandolina mandoline

| REF | (cm) | |
|-----------|-----------|--------|
| 043075759 | 40x11.5x9 | 01/012 |



1

2 lâminas fixas com regulador
2 fixed blades with regulator
2 cuchillas fijas con regulador
2 lames fixes avec régulateur

2

3 lâminas de palitar
3 blades
3 cuchillas
3 lames

3

pega de segurança
handle security
manejar la seguridad
gérer la sécurité

Atenção: as lâminas são extremamente afiadas. Esta mandolina é totalmente feita em aço 304
Caution: the blades are extremely sharp. This mandoline is completely made of steel 304.
Precaución: Las cuchillas son muy afiladas. Esta mandolina está hecho completamente de acero 304.
Attention: les lames sont extrêmement tranchantes. Cette mandoline est entièrement en acier 304.



MANDOLINA 5 LÂMINAS

mandoline mandolina mandoline

| REF | (cm) | |
|------------|------------------------------|--------|
| 0730751005 | 36x12x16 21.5x9.5x1.2 (5x) | 01/012 |



corde em V: juliana fina e grossa; rodelas ultra finas, finas e grossas

cutting V: thin and thick julienne; sliced ultra thin, thin and thick

corde en V: juliana fina y gruesa; rodajas ultra fino, delgado y grueso

coupe en V: julienne fine et épaisse; tranches ultra minces, minces et épaisses

2 lâminas 8x8x1.5
base com ventosa

2 blades 8x8x1.5
suction cup base

2 cuchillas 8x8x1.5
base con ventosa

2 lames 8x8x1.5
base ventouse



MÁQUINA PALITAR BATATAS

chips slicer machine
máquina corta patatas
coupe-frites

| REF | (cm) | |
|------------|-------------|--------|
| 0733880959 | 25.5x9x14.5 | 01/024 |



MANDOLINA 4 LÂMINAS

mandoline mandolina mandoline

| REF | (cm) | |
|------------|--------------|--------|
| 0734040043 | 33x11.5x13.5 | 01/012 |



CORTADOR TRIPLO

cutter cortador coupeur

| REF | (cm) | |
|------------|-------|--------|
| 0734040066 | Ø15.5 | 01/054 |



INOX

PP



CORTADOR
cutter cortador coupeur

| REF | (cm) | |
|------------|--------------------------|--------|
| 0433870021 | 17x10.5x6.3 10x10 (2x) | 01/100 |

AL



CORTA OVOS
egg cutter cortahuevos coupe-oeuf

| REF | (cm) | |
|------------|------|--------|
| 0430684801 | 13x8 | 01/144 |

INOX

PP



CORTA OVOS DUPLO
egg cutter cortahuevos coupe-oeuf

| REF | (cm) | |
|------------|----------|--------|
| 0430756161 | 21.5x8.5 | 24/048 |

ABS



CORTADOR P/FEIJÃO VERDE
cutter for green bean
cortador para judias verdes
éplucheur haricots verts

| REF | (cm) | |
|--|----------|--------|
| 0433870114 | 13x3x2.5 | 01/144 |
| com 6 lâminas with 6 blades con 6 cuchillas avec 6 lames | | |



CORTADOR D/TOMATE
tomato cutter cortador de tomate coupeur de tomate

| REF | (cm) | |
|------------|---------|--------|
| 0432100008 | 48x31.5 | 01/001 |



FERRO
IRON
HIERRO
FER



PICADORA D/CARNE
meat mincer picadora de carne hachoir

| REF | (cm) | |
|------------|---------------------|--------|
| 0433500022 | 26x13x18 nº22 | 01/005 |
| 0432290032 | 30.5x15x20.5 nº31 | 01/002 |

FERRO FUNDIDO CAST IRON HIERRO FUNDIDO FONTE

FERRO
IRON
HIERRO
FER



PICADORA D/CARNE
meat mincer picadora de carne hachoir

| REF | (cm) | |
|------------|-------------------|--------|
| 0432290010 | 18.5x11x27 nº10 | 01/010 |

FERRO FUNDIDO CAST IRON HIERRO FUNDIDO FONTE

INOX



MÁQUINA PALITAR BATATAS
chips slicer machine máquina corta patatas coupe-frites

| REF | (cm) | |
|------------|------------|--------|
| 0433500001 | 56x37.7x44 | 01/006 |

KIT LÂMINAS
blades cuchillas lames

| REF | (cm) | |
|-------------|-------|--------|
| 04335000012 | 10x10 | 01/001 |

2 lâminas com 8/10mm
2 blades with 8/10mm
2 cuchillas con 8/10mm
2 lames avec 8/10mm





UTENSÍLIOS CORTE

cutting utensils utensilios corte ustensiles coupe

1 lâmina com 10mm
1 blade with 10mm
1 cuchilla con 10mm
1 lame avec 10mm



MÁQUINA PALITAR BATATAS
chips slicer machine máquina corta patatas coupe-frites

| REF | (cm) | |
|------------|------------|--------|
| 0433500010 | 44x25x33.5 | 01/002 |

KIT LÂMINAS
blades cuchillas lames

| REF | (cm) | |
|------------|-------|--------|
| 0433500011 | 8x8 | 01/001 |
| 0433500012 | 10x10 | 01/001 |



MÁQUINA D/ENCHIDOS
sausage machine máquina de relleno machine saucisse

| REF | (cm) | LT | |
|------------|--------------|----|--------|
| 1334140005 | 30.4x30.4x64 | 5 | 01/001 |

MODELO model modelo modèle SSM-2
CAPACIDADE capacity capacidad capacité 5LT

funis funnels embudos entonnoirs
Ø1.6cm | Ø2.2cm | Ø3.2cm | Ø3.8cm



MÁQUINA D/ENCHIDOS
sausage machine máquina de relleno machine saucisse

| REF | (cm) | LT | |
|------------|----------|----|--------|
| 1332389992 | 30x34x69 | 5 | 01/001 |

MODELO model modelo modèle SSV-2
CAPACIDADE capacity capacidad capacité 5LT

funis funnels embudos entonnoirs
Ø1.6cm | Ø2.2cm | Ø3.2cm | Ø3.8cm

cilindro cylinder cilindro cylindre
Ø15x32cm



MÁQUINA D/ENCHIDOS
sausage machine máquina de relleno machine saucisse

| REF | (cm) | |
|-------------|----------------------|--------|
| 04322910101 | 45.5x14.5x15 4.5kg | 01/004 |

funis funnels embudos entonnoirs Ø1.5x14 | Ø2x14 | Ø2.5x14cm



MÁQUINA D/HAMBURGUERS
hamburguers machine
máquina de hamburguesa
machine de hamburger

| REF | (cm) | |
|------------|--------------------------|--------|
| 0432100100 | 1 32.5x21.5x27.2 5.2kg | 01/001 |
| 0433500130 | 2 37x25x50 5kg | 01/001 |

1 **MODELO model modelo modèle HF-100**
PESO weight peso poids 5.2KG
DIÂMETRO diameter diámetro diamètre Ø10cm

2 **MODELO model modelo modèle JSHM-130**
PESO weight peso poids 5KG
DIÂMETRO diameter diámetro diamètre Ø13cm



MÁQUINA P/ESTENDER E CORTAR MASSA
pasta machine
máquina para pasta
machine à pâte

| REF | (cm) | |
|------------|--------------|--------|
| 0433600150 | 19.5x20x15 | 01/006 |
| 0433600180 | 22.5x20x14.5 | 01/006 |
| 0433600260 | 30.5x17x15 | 01/004 |



ACESSÓRIO P/RAVIOLI
ravioli cutter accesorio para ravioli accessoire pour ravioli

| REF | (cm) | |
|------------|-------------|--------|
| 0433600003 | 165.x11x7.5 | 01/012 |





INOX **ABS**

CORTA PIZZA
pizza cutter cortapizza roulette pizza

| REF | (cm) | |
|------------|------------|--------|
| 0432790004 | Ø10.2x22.8 | 12/072 |



INOX **PP**

CORTA MASSA
pasta cutter cortamasa roulette découpe pâtes

| REF | (cm) | |
|-------------|-------|--------|
| 04307200202 | Ø8x22 | 01/012 |

corde frisado frizz cut corte frizado coupe frisottis



INOX **NYLON**

CORTA MASSA
pasta cutter cortamasa roulette découpe pâtes

| REF | (cm) | |
|------------|---------|--------|
| 0432517765 | Ø6x18.5 | 12/144 |

corde frisado frizz cut corte frizado coupe frisottis



FACA P/PIZZA
knife to pizza cuchillo para pizza couteau pour pizza

| REF | (cm) | |
|------------|-------|--------|
| 0430720020 | 52x12 | 06/024 |



PP

FACA P/CHURRASCO
barbecue knife cuchillo para barbacoa couteau pour barbecue

| REF | (cm) | |
|------------|------|--------|
| 0430721378 | 22 | 12/600 |



NYLON **FIBRA FIBRE**

FACA D/LÂMINA CURVA
knife cuchillo couteau

| REF | (cm) | |
|------------|------|--------|
| 0432517917 | 17.7 | 12/144 |



NYLON **FIBRA FIBRE**

FACA P/FRUTA/LEGUMES
fruit/vegetables knife
cuchillo fruta/verduras
couteau fruits/legumes

| REF | (cm) | |
|------------|---------|--------|
| 0432517918 | 22.5x10 | 12/144 |



NYLON **FIBRA FIBRE**

FACA D/BAR
knife cuchillo couteau

| REF | (cm) | |
|------------|------|--------|
| 0432517919 | 22 | 12/144 |



INOX **PACK 6**

FACA P/BIFE
knife cuchillo couteau

| REF | (cm) | |
|------------|------|--------|
| 0434070109 | 22.5 | 06/300 |



INOX **PACK 6**

FACA P/BIFE
knife cuchillo couteau

| REF | (cm) | |
|------------|------|--------|
| 0434071029 | 23 | 06/300 |





UTENSÍLIOS CORTE
cutting utensils utensilios corte ustensiles coupe



FUZIL
sharpening chaira aiguseur couteau

| REF | (cm) | |
|-------------|------|--------|
| 04322700014 | 20 | 12/048 |



FUZIL
sharpening chaira aiguseur couteau

| REF | (cm) | |
|------------|------|--------|
| 0432273291 | 20 | 12/048 |



SUPORTE MAGNÉTICO P/FACAS
magnet support for knives
soporte magnético para cuchillos
support magnetique pour couteaux

| REF | (cm) | |
|------------|------|--------|
| 0432273278 | 45 | 01/020 |



TESOURA D/COZINHA
knife scissor tijera de cocina ciseaux pour cuisine

| REF | (cm) | |
|------------|------|--------|
| 0432270485 | 21.3 | 01/120 |



TESOURA D/COZINHA
knife scissor tijera de cocina ciseaux pour cuisine

| REF | (cm) | |
|------------|------|--------|
| 0433870020 | 20 | 01/025 |



TESOURA P/AVES
poultry scissor tijera para aves ciseaux pour volaille

| REF | (cm) | |
|------------|------|--------|
| 0432270115 | 23 | 10/100 |



TESOURA P/AVES
poultry scissor tijera para aves ciseaux pour volaille

| REF | (cm) | |
|-------------|------|--------|
| 04307544104 | 24.5 | 10/080 |



ESCAMADOR
fish scaler escamador ecailleur

| REF | (cm) | |
|------------|------|--------|
| 0433870228 | 19 | 01/024 |



ESCAMADOR
fish scaler escamador ecailleur

| REF | (cm) | |
|------------|------|--------|
| 0430687001 | 20 | 60/240 |



ESCAMADOR
fish scaler escamador ecailleur

| REF | (cm) | |
|-------------|------|--------|
| 04322703001 | 21.5 | 01/025 |



FACA P/OSTRA
knife to oyster cuchillo para ostras couteau pour huitre

| REF | (cm) | |
|------------|------|--------|
| 0433870063 | 15x5 | 01/072 |



carne crua
raw meat
carne cruda
viande raw



peixe cru
raw fish
pescado crudo
poisson



carne de aves
raw poultry
carne cruda de pollo
viande de volaille



frutas e vegetais
fruits and vegetables
frutas y verduras
fruits et légumes



alimentos cozinhados
cooked food
alimentos cocinados
aliments cuisinés



padaria e pastelaria
bakery and pastry
panadería y pastelería
boulangerie et pâtisserie

facos anti-deslizantes
non slip plugs
facos antidesslizantes
cales antidérapantes



TÁBUA D/CORTE

cutting board tabla de corte couteau planche à découper

| REF | (cm) | | |
|-------------|-----------|---|--------|
| 07333410631 | 40x30x1.5 | ■ | 01/001 |
| 0733341046 | 40x30x2 | ■ | 01/001 |
| 0733345030 | 50x30x1.5 | ■ | 01/001 |
| 0733341057 | 50x30x2 | ■ | 01/001 |
| 0733341039 | 60x40x2 | ■ | 01/001 |
| 07333410633 | 40x30x1.5 | ■ | 01/001 |
| 0733341047 | 40x30x2 | ■ | 01/001 |
| 07333450301 | 50x30x1.5 | ■ | 01/001 |
| 0733341052 | 50x30x2 | ■ | 01/001 |
| 0733341040 | 60x40x2 | ■ | 01/001 |
| 07333410635 | 40x30x1.5 | ■ | 01/001 |
| 0733341048 | 40x30x2 | ■ | 01/001 |
| 07333450302 | 50x30x1.5 | ■ | 01/001 |
| 0733341051 | 50x30x2 | ■ | 01/001 |
| 07333410411 | 60x40x2 | ■ | 01/001 |
| 07333410632 | 40x30x1.5 | ■ | 01/001 |
| 0733341045 | 40x30x2 | ■ | 01/001 |
| 07333450303 | 50x30x1.5 | ■ | 01/001 |
| 0733341056 | 50x30x2 | ■ | 01/001 |
| 07333410381 | 60x40x2 | ■ | 01/001 |
| 07333410636 | 40x30x1.5 | ■ | 01/001 |
| 0733341049 | 40x30x2 | ■ | 01/001 |
| 07333450305 | 50x30x1.5 | ■ | 01/001 |
| 0733341054 | 50x30x2 | ■ | 01/001 |
| 07333410422 | 60x40x2 | ■ | 01/001 |
| 07333410634 | 40x30x1.5 | □ | 01/001 |
| 0733341044 | 40x30x2 | □ | 01/001 |
| 07333450304 | 50x30x1.5 | □ | 01/001 |
| 0733341053 | 50x30x2 | □ | 01/001 |
| 0733341037 | 60x40x2 | □ | 01/001 |



UTENSÍLIOS CORTE

cutting utensils utensilios corte ustensiles coupe

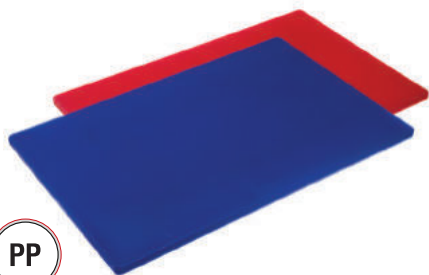

PP

TÁBUA D/CORTE

cutting board tabla de corte couteau planche à découper

| REF | (cm) | | |
|------------|-----------|--|--------|
| 0737885414 | 43x30x1.2 | | 01/010 |



INOX

ABRE LATAS PROFISSIONAL

professional can opener
abrelatas profesional
ouvre-boîte professionnel

| REF | (cm) | | |
|------------|-----------|--|--------|
| 0432170006 | 8x6 nº6 | | 01/120 |



PP

TÁBUA D/CORTE

cutting board tabla de corte couteau planche à découper

| REF | (cm) | | |
|-------------|-----------|--|--------|
| 07333410081 | 35x25x2 | | 01/001 |
| 0733341010 | 40x30x1.2 | | 01/001 |



INOX

TÁBUA P/6 TÁBUAS

holder cutting boards
soporte para tablas
ciseaux pour volaille

| REF | (cm) | | |
|------------|--------------|--|--------|
| 0433658359 | 29.5x21x37.5 | | 01/004 |



INOX

ABRE LATAS PROFISSIONAL

professional can opener
abrelatas profesional
ouvre-boîte professionnel

| REF | (cm) | | |
|------------|------|--|--------|
| 0433658088 | 15 | | 10/100 |



BAMBU

TÁBUA D/CORTE

cutting board tabla de corte couteau planche à découper

| REF | (cm) | | |
|------------|-----------|--|--------|
| 1133717134 | 40x30x1.8 | | 01/012 |



INOX

TÁBUA P/6 TÁBUAS

holder cutting boards
soporte para tablas
ciseaux pour volaille

| REF | (cm) | | |
|------------|------------|--|--------|
| 0433658323 | 22x24.5x32 | | 01/006 |



INOX

ABRE LATAS UNIVERSAL

universal can opener
abrelatas universal
ouvre-boîte universel

| REF | (cm) | | |
|------------|------|--|--------|
| 0430758398 | 16 | | 12/240 |



BAMBU

TÁBUA D/CORTE

cutting board tabla de corte couteau planche à découper

| REF | (cm) | | |
|------------|-----------|--|--------|
| 1133711414 | 35x25x1.5 | | 01/012 |



INOX

TÁBUA P/10 TÁBUAS

holder cutting boards
soporte para tablas
ciseaux pour volaille

| REF | (cm) | | |
|------------|------------|--|--------|
| 0433658326 | 39.5x35x28 | | 01/006 |



AL

QUEBRA NOZES

nutcracker cascanueces casse-noisette

| REF | (cm) | | |
|------------|---------------|--|--------|
| 0433871169 | 1 16.2 | | 01/025 |
| 0430684402 | 2 15.5 | | 01/024 |



UTENSÍLIOS PASTELARIA

pastry utensils utensilios repostería ustensiles pâtisserie



UTENSÍLIOS PASTELARIA

pastry utensils utensílios pasteleria ustensiles pâtisserie



JARRO MEDIDOR BASIC
measuring jug jarro medidor pot mesureur

| REF | (cm) | CL | |
|------------|------------|----|--------|
| 0331595062 | Ø11.5x11.5 | 50 | 01/006 |



JARRO MEDIDOR
measuring jug jarro medidor pot mesureur

| REF | (cm) | LT | |
|------------|------------|----|--------|
| 0730260606 | Ø11.5x16.5 | 1 | 01/024 |
| 0730260605 | Ø14.5x21.5 | 2 | 01/024 |
| 0730260604 | Ø16.5x24 | 3 | 01/024 |



JARRO MEDIDOR
measuring jug jarro medidor pot mesureur

| REF | (cm) | LT | |
|------------|----------|----|--------|
| 0433518190 | Ø10x14.3 | 1 | 01/012 |



NOVO new



ÇAÇAROLETE
casserole cacerolita casserole

| REF | (cm) | |
|------------|-------|--------|
| 0433430018 | Ø18x8 | 01/006 |



ÇAÇAROLETE
casserole cacerolita casserole

| REF | (cm) | LT | |
|-------------|------|-----|--------|
| 04339031001 | Ø18 | 2 | 01/028 |
| 04339031002 | Ø20 | 2.5 | 01/020 |



ÇAÇAROLETE BANHO MARIA
casserole cacerolita casserole

| REF | (cm) | |
|-------------|--------|--------|
| 04312690101 | Ø10x10 | 01/024 |
| 0431269012 | Ø12x12 | 01/024 |



ÇAÇAROLETE
casserole cacerolita casserole

| REF | (cm) | |
|------------|---------|--------|
| 0433787207 | Ø14x7 | 01/120 |
| 0433787245 | Ø16x7.5 | 01/120 |
| 0433787160 | Ø18x8 | 01/120 |



ÇAÇAROLETE
casserole cacerolita casserole

| REF | (cm) | |
|-------------|---------|--------|
| 0430971819 | Ø14x7.8 | 06/024 |
| 04309718191 | Ø16x9.5 | 06/024 |



FUNIL CONFEITARIA + SUPORTE
confectionery funnel + stand
embudo dosificador + soporte
entonnoir doseur + support

| REF | (cm) | |
|------------|-------------------------|--------|
| 0430683304 | Ø18x24 Ø16xØ18.5x20.5 | 12/012 |



SUPORE P/FUNIL
stand for funnel soporte para embudo support pour entonnoir

| REF | (cm) | |
|-------------|-------|--------|
| 04312600462 | 33x23 | 01/048 |



FUNIL CONFEITARIA
confectionery funnel embudo dosificador entonnoir doseur

| REF | (cm) | |
|------------|--------|--------|
| 0437720018 | Ø14x20 | 01/001 |

SUPORE P/FUNIL
stand for funnel soporte para embudo support pour entonnoir

| REF | (cm) | |
|-------------|----------|--------|
| 04377200181 | Ø18x20.5 | 01/024 |



CONJUNTO 4 MEDIDAS
set measuring bowl
set tazas medidoras
ensemble bols mesureurs

| REF | (cm) | ML | |
|------------|------|----------------|--------|
| 0433652110 | - | 0.2/0.3/0.6/15 | 10/100 |



CONJUNTO 4 MEDIDAS
set measuring bowl
set tazas medidoras
ensemble bols mesureurs

| REF | (cm) | ML | |
|------------|------|---------------|--------|
| 0433653200 | - | 60/80/125/250 | 01/060 |



SEPARADOR DE CLARAS
eggs separator separador de claras séparateur à oeuf

| REF | (cm) | |
|------------|---------|--------|
| 0432253238 | Ø6.5x12 | 01/384 |



PENEIRA
sieve cedazo tamis

| REF | (cm) | |
|------------|------|--------|
| 0431260021 | Ø21 | 01/012 |
| 0431260026 | Ø26 | 01/012 |
| 0431260029 | Ø29 | 01/012 |



PENEIRA C/4 REDES AMOVÍVEIS
sieve cedazo tamis

| REF | (cm) | |
|-------------|------|--------|
| 04312600261 | Ø24 | 01/012 |

PENEIRA
sieve cedazo tamis

| REF | (cm) | |
|------------|------|--------|
| 0732302101 | Ø16 | 01/050 |
| 0732302102 | Ø20 | 01/050 |
| 0732302103 | Ø26 | 01/050 |
| 0732302104 | Ø30 | 01/012 |



VARA BATEDORA 12 VARAS
whisk 12 wires batidor 12 varillas fouet 12 fils

| REF | (cm) | |
|------------|------|--------|
| 0436920002 | 40 | 01/024 |
| 0436920001 | 47 | 12/072 |



VARA BATEDORA 8 VARAS
whisk 8 wires batidor 8 varillas fouet 8 fils

| REF | (cm) | |
|-------------|------|--------|
| 04312600421 | 107 | 01/006 |



UTENSÍLIOS PASTELARIA

pastry utensils utensilios pastelería ustensiles pâtisserie



VARA BATEDORA 12 VARAS
whisk 12 wires batidor 12 varillas fouet 12 fils

| REF | (cm) | |
|------------|------|--------|
| 0430683544 | 40 | 12/072 |



VARA BATEDORA 8 VARAS
whisk 8 wires batidor 8 varillas fouet 8 fils

| REF | (cm) | |
|------------|------|--------|
| 0434070112 | 34 | 01/072 |



VARA BATEDORA 16 VARAS
whisk 16 wires batidor 16 varillas fouet 16 fils

| REF | (cm) | |
|-------------|------|--------|
| 04312600256 | 25 | 01/120 |
| 04312600303 | 30 | 01/120 |



VARA BATEDORA 16 VARAS
whisk 16 wires batidor 16 varillas fouet 16 fils

| REF | (cm) | |
|------------|------|--------|
| 0433650725 | 25 | 01/030 |
| 0433650730 | 30 | 01/030 |
| 0433650735 | 35 | 01/030 |
| 0433650740 | 40 | 01/030 |



VARA BATEDORA 8/9 VARAS
whisk 8/9 wires batidor 8/9 varillas fouet 8/9 fils

| REF | (cm) | |
|-------------|--------------------------------|--------|
| 0432270200 | 35/8 varas wires varillas fils | 10/040 |
| 04322702001 | 40/9 varas wires varillas fils | 06/024 |



VARA BATEDORA ROTATIVA
rotary whisk batidor rotatorio fouet rotatif

| REF | (cm) | |
|------------|------|--------|
| 0432270100 | 36 | 25/100 |



VARA BATEDORA 10 PONTAS
whisk 10 wires batidor 10 varillas fouet 10 fils

| REF | (cm) | |
|------------|------|--------|
| 0433651130 | 30 | 01/030 |



ESPÁTULA
spatula espátula spatule

| REF | (cm) | |
|-------------|--------|--------|
| 04322700281 | 24.5x6 | 25/100 |

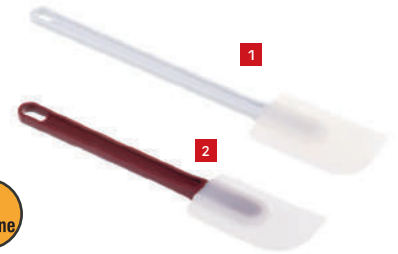

RAPA TACHOS
spatula espátula spatule

| REF | (cm) | |
|---------------------|--------|--------|
| 0430720016 1 | 40x7.3 | 12/144 |
| 0733610001 2 | 25x5 | 12/360 |
| 0430720014 | 36x7 | 12/144 |



ESPÁTULA
spatula espátula spatule

| REF | (cm) | |
|----------------------|--------|--------|
| 04307200161 1 | 40x8 | 12/144 |
| 0733610004 2 | 25x6.5 | 01/360 |
| 0733610005 | 36x8 | 01/144 |

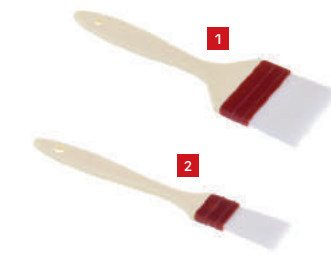

PINCEL
brush pincel pinceau

| REF | (cm) | |
|----------------------|----------|--------|
| 07323000012 1 | 19.5x3.8 | 20/200 |
| 07323000011 | 21.5x6.4 | 20/200 |
| 07323000013 2 | 18x2.5 | 20/200 |



PINCEL
brush pincel pinceau

| REF | (cm) | |
|------------|------|--------|
| 0432270028 | 28 | 25/100 |



PP

ROLO
rolling pin rodillo rouleau

| REF | (cm) | |
|------------|-------|--------|
| 0732300008 | Ø4x50 | 01/040 |



INOX

ROLO
rolling pin rodillo rouleau

| REF | (cm) | |
|------------|---------|--------|
| 0430683212 | Ø3.2x45 | 01/024 |



INOX

ROLO
rolling pin rodillo rouleau

| REF | (cm) | |
|------------|---------|--------|
| 0430683203 | Ø7.5x25 | 01/010 |



INOX

RASPADOR
scraper rasqueta raclette

| REF | (cm) | |
|------------|----------|--------|
| 0431260610 | 1 10x8.5 | 01/144 |
| 0431260475 | 2 12x10 | 01/144 |



INOX

RASPADOR
scraper rasqueta raclette

| REF | (cm) | |
|------------|-------------|--------|
| 0432790022 | 1 16.5x11.5 | 12/072 |
| 0430721061 | 2 16.5x11.5 | 12/120 |

+ 240°
- 40°

Si
silicone



RASPADOR
scraper rasqueta raclette

| REF | (cm) | |
|------------|--------|--------|
| 0430755547 | 17x9.7 | 24/096 |

PP



RASPADOR
scraper rasqueta raclette

| REF | (cm) | |
|------------|---------|--------|
| 0732300904 | 19x12.4 | 01/500 |

PP

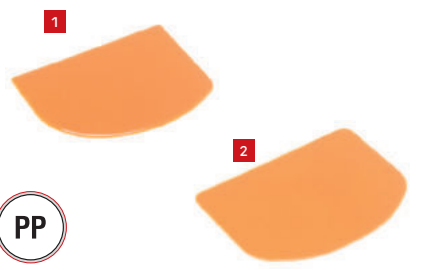

RASPADOR
scraper rasqueta raclette

| REF | (cm) | |
|------------|------------|--------|
| 0732309270 | 1 10.7x8 | 01/500 |
| 0732300936 | 2 12.6x9.7 | 01/500 |

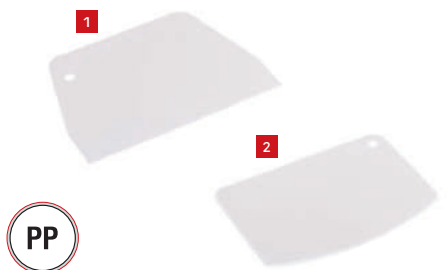

PP

RASPADOR
scraper rasqueta raclette

| REF | (cm) | |
|-------------|-------------|--------|
| 0732300900 | 1 15.5x10.5 | 01/300 |
| 07323009001 | 2 13.5x9.5 | 01/300 |



PP

PACK 5

CONJUNTO 5 RASPADORES
set scrapers conjunto rasquetas resemble raclettes

| REF | (cm) | |
|-------------|--------|--------|
| 07323009002 | 13x9.7 | 01/240 |

PP



ALISADOR FONDANT
easy-glide fondant smoother
alisador pasta azúcar
spatule fondant

| REF | (cm) | |
|------------|----------|--------|
| 0732300318 | 14.5x8.5 | 01/500 |



UTENSÍLIOS PASTELARIA

pastry utensils utensilios pastelería ustensiles pâtisserie



INOX

FRISADOR MASSAS
roller rodillo picar pastas rouleau pique vite

| REF | (cm) | |
|------------|---------|--------|
| 0432790046 | 15x19.5 | 04/036 |



INOX

FRISADOR MASSAS
roller rodillo picar pastas rouleau pique vite

| REF | (cm) | |
|------------|---------|--------|
| 0432790045 | 15x20.5 | 04/036 |



ABS

FRISADOR MASSAS
roller rodillo picar pastas rouleau pique vite

| REF | (cm) | |
|------------|---------|--------|
| 0732300056 | 12.5x20 | 01/200 |



ABS

ROLO PICAR MASSAS
roller rodillo picar pastas rouleau pique vite

| REF | (cm) | |
|------------|---------|--------|
| 0732300057 | 12.5x21 | 01/500 |



INOX

CORTA MASSA EXTENSÍVEL
extendable cutter roller
cortapastas extensible
rouleau extensible

| REF | (cm) | | |
|------------|------|----|--------|
| 0430720005 | 24.5 | 5* | 01/030 |
| 0430720007 | 24.5 | 7* | 01/030 |

*rodas castors ruedas roulettes



INOX

CORTA MASSAS
pastry cutter cortapasta coupe pâte

| REF | (cm) | |
|------------|-------|--------|
| 0430686701 | 18x12 | 01/020 |



INOX

CORTADOR/NIVELADOR BOLOS
cake cutter / slide cortador/deslizador tortas
diviseur francheur

| REF | (cm) | |
|------------|---------|--------|
| 0732301207 | 1 50x23 | 01/020 |
| 0732301208 | 2 32x13 | 01/200 |



AL

MARCADOR BOLOS
cake divider marcadore tartas séparateur portions

| REF | (cm) | | |
|------------|------|----|--------|
| 0430683706 | 023 | 10 | 12/048 |





ABS

MARCADOR BOLOS
cake divider marcador tartas séparateur portions

| REF | (cm) | | |
|------------|-------|-------|--------|
| 0732300003 | Ø27 | 10/12 | 01/048 |
| 0732300527 | Ø27 | 12/18 | 12/048 |
| 0732300526 | Ø26.5 | 14/16 | 01/240 |



INOX

FORMA P/LAMINAR BOLOS
mould for laminating cakes
molde para laminar pasteles
cercle extensible guide coupe gâteau

| REF | (cm) | |
|------------|-------|--------|
| 0732302005 | Ø24x8 | 01/020 |



1

2

INOX PP

ESPÁTULA
spatula espátula spatule

| REF | (cm) | |
|-------------|----------|-----------------|
| 0430722004 | 1 | 21.5x2.5 12/120 |
| 04307220061 | 27.5x3.5 | 12/144 |
| 0430722010 | 37.5x3.8 | 12/144 |
| 0430722012 | 43x4 | 12/144 |
| 04307220141 | 48x4 | 12/144 |
| 0430723006 | 2 | 27.5x3.2 12/144 |
| 04312600109 | 39x4 | 10/120 |
| 04312600120 | 43.8x4 | 10/120 |
| 04312600140 | 49.4 | 10/120 |



INOX NYLON

ESPÁTULA CONFEITARIA
spatula espátula spatule

| REF | (cm) | |
|------------|--------|--------|
| 0433657838 | 36.5x3 | 01/096 |



ABS

MARCADOR PÃO ESTRELA
bread dough maker marcador de pan marquer inciseurs

| REF | (cm) | |
|------------|--------|--------|
| 0732301446 | Ø8x3.5 | 01/300 |



INOX

ESPÁTULA
spatule espátula spatule

| REF | (cm) | |
|------------|--------|--------|
| 0430721101 | 28x5.8 | 12/144 |



INOX ABS

ESPÁTULA P/BOLO
spatula espátula spatule

| REF | (cm) | |
|------------|------|--------|
| 0430750103 | 26.5 | 01/100 |



INOX

ESPÁTULA P/BOLO
spatula espátula spatule

| REF | (cm) | |
|------------|------|-----------------|
| 0433658127 | 1 | 27.5x8 01/120 |
| 0430972804 | 2 | 25x6 12/096 |
| 0432790011 | 3 | 27.5x8.5 12/072 |
| 0430725011 | 4 | 27x5.5 12/144 |

INOX

FAÇA PÃO/BOLO
knife cuchillo couteau

| REF | (cm) | |
|------------|------|--------|
| 0430724009 | 34 | 12/144 |



UTENSÍLIOS PASTELARIA

pastry utensils utensilios pastelería ustensiles pâtisserie

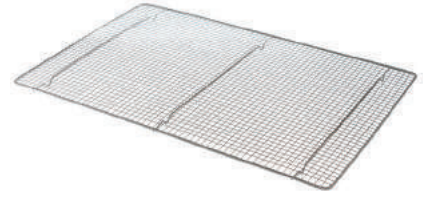

GRELHA PASTELARIA
grate parrilla grille

| REF | (cm) | |
|------------|-------|--------|
| 0430687101 | 45x25 | 01/040 |

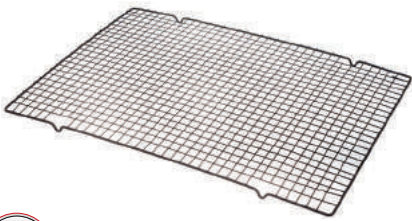

GRELHA PASTELARIA
grate parrilla grille

| REF | (cm) | |
|------------|---------|--------|
| 0430750220 | 50x36.8 | 01/024 |

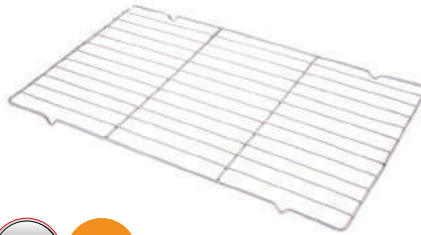

GRELHA
grate parrilla grille

| REF | (cm) | |
|------------|---------|--------|
| 0433658153 | 53x32.5 | 01/030 |

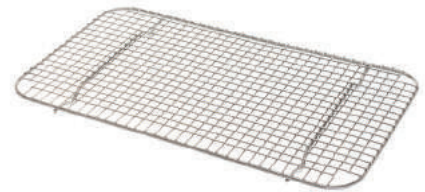

GRELHA
grate parrilla grille

| REF | (cm) | |
|------------|---------|--------|
| 0432611001 | 53x32.5 | 02/024 |

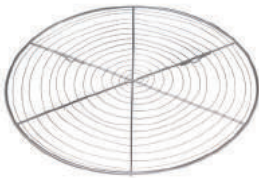

REDE PASTELARIA
pastry grid rejilla pastelería grille pâtisserie

| REF | (cm) | |
|------------|------|--------|
| 0432253165 | Ø32 | 01/020 |

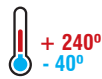

TAPETE SILICONE
non-stick silicon tapete silicona tapis de cuisson

| REF | (cm) | |
|------------|-----------|--------|
| 0430750164 | 40.6x30.5 | 24/096 |

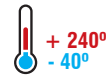

TAPETE SILICONE
non-stick silicon tapete silicona tapis de cuisson

| REF | (cm) | |
|------------|---------|--------|
| 0430720053 | 53x32.5 | 00/100 |

com fibra de vidro
with fiberglass
con fibra de vidrio
avec fibre de verre

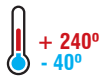

TAPETE SILICONE
non-stick silicon tapete silicona tapis de cuisson

| REF | (cm) | |
|------------|-------|--------|
| 0430720034 | 42x30 | 01/100 |
| 0430726040 | 60x40 | 01/050 |

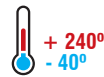

**NOVO
new**



TAPETE SILICONE
non-stick silicon tapete silicona tapis de cuisson

| REF | (cm) | |
|-------------|---------|--------|
| 04322701001 | 53x32.5 | 25/100 |



MAÇARICO PASTELARIA
pastry torch soplete chalumeau de cuisine

| REF | (cm) | | |
|------------|------|-----------------|--------|
| 0932110012 | 18.5 | 1300°C (2450°F) | 01/001 |



RECARGA GÁS UNIVERSAL FLAMECL
universal gas gas universal gaz universal

| REF | (cm) | ML | |
|------------|------|-----|--------|
| 0931061008 | - | 250 | 00/000 |



MAÇARICO C/RECARGA
torch with recharge soplete con recarga
chalumeau de cuisine avec recharge

| REF | (cm) | GRS | |
|------------|------|-----|--------|
| 0931061014 | - | 250 | 01/001 |



RECARGA GÁS BUTANO
universal butane gas butano universal gaz butane universal

| REF | (cm) | GRS | |
|-------------|------|-----|--------|
| 09310610021 | - | 250 | 00/000 |



EXPOSITOR BOLOS
cake stand expositor de tartas présentoir de tartes

| REF | (cm) | |
|-------------|---------|--------|
| 04312600102 | Ø31x4.5 | 01/006 |



não rotativo **no revolving** no giratorio no giratoire



EXPOSITOR BOLOS
cake stand expositor de tartas présentoir de tartes

| REF | (cm) | |
|-------------|-------|--------|
| 07308300301 | Ø30x8 | 01/012 |



não rotativo **no revolving** no giratorio no giratoire



EXPOSITOR BOLOS GIRATÓRIO
cake stand expositor de tartas présentoir de tartes

| REF | (cm) | |
|------------|---------|--------|
| 0732301001 | Ø27x7.6 | 01/012 |



DISPENSADOR DE MOLHOS
sauce dispenser dispensador de salsas distributeur sauces

| REF | (cm) | LT | |
|------------|----------|-----|--------|
| 0332990820 | 8.4x18.4 | 0.9 | 01/012 |



DOSEADOR PASTELARIA
pastry dispenser
dosificador de pasteleria
bol doseur / pâtisserie

| REF | (cm) | LT | |
|------------|---------|------|--------|
| 0733590001 | 11x18.5 | 0.82 | 01/012 |



DOSEADOR AÇÚCAR
sugar dispenser dosificador de açúcar doseur de sucre

| REF | (cm) | |
|------------|-----------|--------|
| 0331590078 | Ø5x15 | 01/012 |
| 0332441141 | Ø7.5x13.5 | 01/048 |



POLVILHADOR
powder shaker espolvoador saupoudreuse

| REF | (cm) | |
|------------|-------|--------|
| 0332440046 | Ø7x14 | 01/048 |





UTENSÍLIOS PASTELARIA

pastry utensils utensilios pastelería ustensiles pâtisserie



INOX



POLVILHADOR
powder shaker espolvoreador saupoudreuse

| REF | (cm) | |
|------------|-------|--------|
| 0433518147 | Ø8x17 | 06/024 |

INOX

POLVILHADOR
powder shaker espolvoreador saupoudreuse

| REF | (cm) | |
|--------------------------|--------|--------|
| 0430971615 ¹ | Ø7x9.5 | 12/072 |
| 04309716151 | Ø7x9.5 | 12/072 |
| 04306807021 ² | Ø5.8x8 | 12/100 |
| 04309716152 ³ | Ø7x9.5 | 12/072 |

1



2



3



INOX



POLVILHADOR ROTATIVO
powder shaker espolvoreador saupoudreuse

| REF | (cm) | |
|------------|--------|--------|
| 0439200000 | Ø10x13 | 01/036 |

INOX

POLVILHADOR
powder shaker espolvoreador saupoudreuse

| REF | (cm) | |
|--------------------------|---------|--------|
| 0433651492 ¹ | Ø7x9 | 10/100 |
| 0433651493 ² | Ø7x9 | 10/100 |
| 04312600152 ³ | Ø7x13.6 | 01/072 |
| 0431260086 ⁴ | Ø6x8.5 | 01/072 |

1



2



3



4



PC

POLVILHADOR
powder shaker espolvoreador saupoudreuse

| REF | (cm) | |
|--------------------------|--------|--------|
| 0730260280 ¹ | Ø8x9.7 | 01/072 |
| 07302602801 ² | Ø8x9.7 | 01/072 |
| 07302602802 ³ | Ø8x9.7 | 01/072 |

- ¹ furos holes agujeros trous Ø2.3mm
- ² furos holes agujeros trous Ø1.5mm
- ³ furos holes agujeros trous Ø4.5mm

1



2



3





FORMA CORNUCÓPIA
mould molde moule

| REF | (cm) | |
|------------|------|--------|
| 0432790049 | Ø4x6 | 01/240 |



FORMA PUDIM/PANACOTTA
pudding mould molde pudin moule pudding

| REF | (cm) | |
|---------------------|----------|--------|
| 0433654655 1 | Ø7x5 | 12/120 |
| 0433654665 | Ø8x5 | 12/120 |
| 0433651453 2 | Ø7.5x5.2 | 24/192 |



FORMA PUDIM
pudding mould molde pudin moule pudding

| REF | (cm) | |
|----------------------|----------|--------|
| 04312600017 1 | Ø6.5x3.5 | 01/500 |
| 04312600049 2 | Ø6.7x5.6 | 01/250 |
| 0431266342 3 | Ø7x4 | 01/480 |
| 0431267652 | Ø8.5x5 | 01/288 |
| 07323000121 4 | Ø7x5.8 | 01/500 |
| 0732300013 | Ø8x6.2 | 01/500 |
| 0732300014 | Ø9x7 | 01/500 |



FORMA
mould molde moule

| REF | (cm) | |
|------------|-------|--------|
| 0431260062 | Ø15x5 | 01/012 |



FORMA
mould molde moule

| REF | (cm) | |
|-------------|---------|--------|
| 04312600117 | Ø28x2.5 | 01/048 |



TARTEIRA MINI
mould molde moule

| REF | (cm) | |
|------------|-----------|---------|
| 0732300019 | Ø11.8x2.1 | 01/1000 |



FORMA QUEQUE CANELADA
muffins mould molde magdalenas moule muffins

| REF | (cm) | |
|---------------------|----------|---------|
| 0732300202 1 | Ø7.8x3 | 01/1000 |
| 0732300419 2 | Ø7.5x2.8 | 01/500 |



FORMA QUEQUES
muffins mould molde magdalenas moule muffins

| REF | (cm) | |
|------------|---------|--------|
| 0430681011 | 36x28x3 | 01/024 |



TARTEIRA C/BASE AMOVÍVEL
mould with removable base molde fondo desmontable
fourtière avec fond amovible

| REF | (cm) | |
|------------|---------|--------|
| 0732300401 | Ø16x2.3 | 01/100 |
| 0732300402 | Ø20x2.6 | 01/360 |
| 0732300403 | Ø24x2.6 | 01/050 |
| 0732300404 | Ø28x2.6 | 01/050 |





UTENSÍLIOS PASTELARIA

pastry utensils utensilios pastelería ustensiles pâtisserie



AL

BASE P/SEMI FRIO

base for bavarois fondo para semi-frío fond pour parfait

| REF | (cm) | |
|-------------|------|--------|
| 04312600301 | Ø30 | 01/100 |
| 04312600322 | Ø32 | 01/100 |



AL

FORMA QUADRADA

square mould molde cuadrado moule carré

| REF | (cm) | |
|------------|-----------|--------|
| 0732301116 | 15x15x7 | 01/024 |
| 0732301117 | 18x18x7.5 | 01/024 |
| 0732301118 | 20x20x7.5 | 01/024 |



AL

FORMA RECTANGULAR

mould molde moule

| REF | (cm) | |
|------------|----------|--------|
| 0732301732 | 28x9.5x6 | 06/024 |



antiaderente
Non-stick
antiaherente
antiadhésif

FORMA LASAGNA

lasagna baking tray asadera para lasaña plat à lasagne

| REF | (cm) | |
|------------|-------------|--------|
| 0432260498 | 27x24.5x7.5 | 01/024 |



antiaderente
Non-stick
antiaherente
antiadhésif

FORMA QUEQUES

muffins mould molde magdalenas moule muffins

| REF | (cm) | |
|------------|-----------|--------|
| 0432260154 | 35x26.5x3 | 01/012 |



antiaderente
Non-stick
antiaherente
antiadhésif

TARTEIRA C/BASE AMOVÍVEL

mould with removable base molde fondo desmontable
tourtière avec fond amovible

| REF | (cm) | |
|-------------|---------|--------|
| 0432260269 | Ø24.5x5 | 01/024 |
| 0432260263 | Ø26x2.5 | 01/024 |
| 04322602631 | Ø28x2.5 | 01/024 |



antiaderente
Non-stick
antiaherente
antiadhésif

FORMA C/BASE AMOVÍVEL

mould with removable base molde con fondo desmontable
tourtière avec fond amovible

| REF | (cm) | |
|------------|---------|--------|
| 0732302062 | Ø20x6.2 | 06/024 |



antiaderente
Non-stick
antiaherente
antiadhésif

TARTEIRA C/BASE AMOVÍVEL

mould with removable base molde fondo desmontable
tourtière avec fond amovible

| REF | (cm) | |
|------------|-----------|--------|
| 0732300440 | 25x10x2.5 | 01/050 |
| 0430680119 | 10x6x2 | 10/060 |



antiaderente
Non-stick
antiaherente
antiadhésif

MINI TARTEIRA

mould molde tourtière

| REF | (cm) | |
|------------|-------|--------|
| 0432263029 | Ø12x2 | 01/048 |



antiaderente
Non-stick
antiaherente
antiadhésif

FORMA PASTEL

mould molde moule

| REF | (cm) | |
|------------|---------|--------|
| 0432263030 | Ø12.4x2 | 01/024 |



1



2

VIDRO
GLASS
VIDRIO
VERRE

FORMA

mould molde moule

| REF | (cm) | |
|------------|-----------|--------|
| 0331599114 | 1 Ø22x8.5 | 01/006 |
| 0331599654 | 2 Ø11.8x5 | 01/024 |



INOX



CAIXA 7 CORTA MASSAS
set pastry cutter caja cortapastas boîte découpoirs

| REF | (cm) | |
|--|------|--------|
| 04312600071 | ** | 01/072 |
| ** 02.5x4 04x4 05x4 06.5x4 07.5x4 09x4 010x4 | | |

INOX



CAIXA 9 CORTA MASSAS
set pastry cutter caja cortapastas boîte découpoirs

| REF | (cm) | |
|--|------|--------|
| 07323002113 | ** | 01/060 |
| ** 4x3.5x4 5x4x4 6x4.5x4 6.5x5x4 7.5x6x4 8x6.5x4 9x7x4 10x8x4 10.5x8.5x4 | | |

INOX



CAIXA 9 CORTA MASSAS
set pastry cutter caja cortapastas boîte découpoirs

| REF | (cm) | |
|--|------|--------|
| 07323002114 | ** | 01/060 |
| ** 4x3.5x4 5x4x4 6x4.5x4 6.5x5x4 7.5x6x4 8x6.5x4 9x7x4 10x8x4 10.5x8.5x4 | | |

INOX



CAIXA 9 CORTA MASSAS
set pastry cutter caja cortapastas boîte découpoirs

| REF | (cm) | |
|--|------|--------|
| 07323002111 | ** | 01/060 |
| ** 4x4x4 5.5x5x4 6.5x6x4 7x6.5x4 7.5x7x4 8.5x8.5x4 9.5x9.5x4 10x10x4 11x11x4 | | |

INOX



CAIXA 9 CORTA MASSAS
set pastry cutter caja cortapastas boîte découpoirs

| REF | (cm) | |
|--|------|--------|
| 07323002112 | ** | 01/060 |
| ** 4.5x4x4 5.5x5x4 6.5x6x4 7x6.5x4 7.5x7x4 8.5x8.5x4 9.5x9.5x4 10x10x4 11x11x4 | | |

INOX



CAIXA 12 CORTA MASSAS
set pastry cutter caja cortapastas boîte découpoirs

| REF | (cm) | |
|--|------|--------|
| 07323002115 | ** | 01/050 |
| ** 03.4x5.3 04.2x5.3 04.9x5.3 06.4x5.3 07.1x5.3 07.8x5.3 08.5x5.3 09.2x5.3 010x5.3 011.3x5.3 | | |

INOX



CAIXA 12 CORTA MASSAS
set pastry cutter caja cortapastas boîte découpoirs

| REF | (cm) | |
|---|------|--------|
| 07323002101 | ** | 01/050 |
| ** 03.4x5.1 04.2x5.1 04.9x5.1 05.6x5.1 06.4x5.1 07.1x5.1 07.8x5.1 08.5x5.1 09.2x5.1 010x5.1 010.5x5.1 011.3x5.1 | | |

INOX

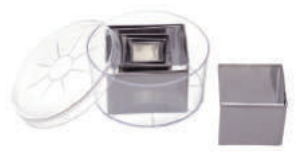

CAIXA 6 CORTA MASSAS
set pastry cutter caja cortapastas boîte découpoirs

| REF | (cm) | |
|--|------|--------|
| 0732300217 | ** | 01/024 |
| ** 3x3x5 4x4x5 5x5x5 6x6x6 8x8x5 | | |

INOX



CAIXA 4 CORTA MASSAS
set pastry cutter caja cortapastas boîte découpoirs

| REF | (cm) | |
|--|------|--------|
| 07323021731 | ** | 01/024 |
| ** 3.5x1.5x5 5x3x5 6.5x4.5x5 8x6x5 | | |



UTENSÍLIOS PASTELARIA

pastry utensils utensilios pastelería ustensiles pâtisserie



INOX

CAIXA 4 CORTA MASSAS
set pastry cutter caja cortapastas boîte découpoirs

| REF | (cm) | |
|---|------|--------|
| 0732302171 | ** | 01/024 |
| ** 5x3.5x5 6.5x4.5x5 8.5x5.5x5 10x7x5 | | |



INOX

CAIXA 8 CORTA MASSAS
set pastry cutter caja cortapastas boîte découpoirs

| REF | (cm) | |
|--|------|--------|
| 0732300215 | ** | 01/024 |
| ** 4x5 5x5 6x5 6.5x5 8x5 9x5 10x5 11x5 | | |



INOX

CAIXA 7 CORTA MASSAS
set pastry cutter caja cortapastas boîte découpoirs

| REF | (cm) | |
|--|------|--------|
| 0732300214 | ** | 01/024 |
| ** 4x4x5 5x5x5 6x6x5 7x7x5 8x8x5 9x9x5 10x10x5 | | |



INOX

CAIXA 4 CORTA MASSAS
set pastry cutter caja cortapastas boîte découpoirs

| REF | (cm) | |
|--|------|--------|
| 0732302170 | ** | 01/024 |
| ** 4.5x4x5 5.5x4x5 6.5x5.5x5 8x7x5 | | |



INOX

CONJUNTO 10 CORTA MASSAS
set pastry cutter caja cortapastas boîte découpoirs

| REF | (cm) | |
|---|------|--------|
| 0430755558 | ** | 12/048 |
| ** medidas diversas various measures diversas medidas diverses mesures | | |

0_9



NYLON

CAIXA 9 CORTA MASSAS
set pastry cutter caja cortapastas boîte découpoirs

| REF | (cm) | |
|---|------|--------|
| 0732300002 | ** | 01/100 |
| ** Ø3x3.5 Ø4x3.5 Ø5x3.5 Ø6x3.5 Ø7x3.5 Ø8x3.5 Ø9x3.5 Ø10x3.5 Ø11x3.5 | | |



NYLON

CAIXA 9 CORTA MASSAS
set pastry cutter caja cortapastas boîte découpoirs

| REF | (cm) | |
|---|------|--------|
| 07323000021 | ** | 01/100 |
| ** Ø3x3.5 Ø4x3.5 Ø5x3.5 Ø6x3.5 Ø7x3.5 Ø8x3.5 Ø9x3.5 Ø10x3.5 Ø11x3.5 | | |



NYLON

CAIXA 8 CORTA MASSAS
set pastry cutter caja cortapastas boîte découpoirs

| REF | (cm) | |
|---|------|--------|
| 0732300251 | ** | 01/060 |
| ** 3x3.5 4x3.5 5.5x3.5 7x3.5 8.5x3.5 10x3.5 11.5x3.5 13x3.5 | | |



NYLON

CAIXA 7 CORTA MASSAS
set pastry cutter caja cortapastas boîte découpoirs

| REF | (cm) | |
|--|------|--------|
| 0732300249 | ** | 01/060 |
| ** 8x2.5x3.5 9x3.5x3.5 10x4.5x3.5 11.5x6x3.5 12x6.5x3.5 13x7.5x3.5 | | |



CAIXA 13 CORTA MASSAS
set pastry cutter caja cortapastas boîte découpoirs

| REF | (cm) | |
|---|------|--------|
| 0730750943 | ** | 01/024 |
| ** medidas diversas various measures diversas medidas diverses mesures | | |



CONJUNTO 6 CORTA MASSAS
set pastry cutter caja cortapastas boîte découpoirs

| REF | (cm) | |
|---|------------------------------|--------|
| 0730750933 | Ø5 Ø6 Ø7 Ø8 Ø9 Ø10 | 01/072 |
| liso / canelado smooth / wavy liso / onulado lisse / ondulé cores sortidas assorted colors cores sortidas couleurs assorties | | |



CAIXA 4 CORTA MASSAS
set pastry cutter caja cortapastas boîte découpoirs

| REF | (cm) | |
|---|------|--------|
| 0730750936 | ** | 00/000 |
| **medidas diversas various measures diversas medidas diverses mesures | | |



CAIXA 4 CORTA MASSAS
set pastry cutter caja cortapastas boîte découpoirs

| REF | (cm) | |
|---|------|--------|
| 0730750937 | ** | 01/072 |
| **medidas diversas various measures diversas medidas diverses mesures | | |



CAIXA 3 CORTA MASSAS
set pastry cutter caja cortapastas boîte découpoirs

| REF | (cm) | |
|---|------|--------|
| 0730750940 | ** | 01/144 |
| **medidas diversas various measures diversas medidas diverses mesures | | |



CORTA MASSAS
pastry cutter cortapastas découpoirs

| REF | (cm) | | |
|------------|-----------|--------|--|
| 0430684203 | 1 4.5x2 | 50/300 | |
| 0430684201 | 2 5x3.5x2 | 01/120 | |
| 0430684205 | 3 4x2 | 50/300 | |



CONJUNTO UTENSÍLIOS
pastry tools utensilios de pasteleria ustensiles pâtisserie

| REF | (cm) | |
|------------|------|--------|
| 0732300010 | - | 01/001 |



ARO EXTENSÍVEL
extensible mould molde extensible moule extensible

| REF | (cm) | |
|------------|-----------|--------|
| 0431261530 | Ø15-Ø30x8 | 01/048 |



ARO
mould molde moule

| REF | (cm) | |
|-------------|--------|--------|
| 0431269003 | Ø6x4 | 01/096 |
| 04312690121 | Ø7x6 | 01/096 |
| 04312600131 | Ø8x6 | 01/096 |
| 04312600098 | Ø9x4.5 | 01/096 |
| 04312600068 | Ø10x4 | 01/096 |



ARO
mould molde moule

| REF | (cm) | |
|-------------|-----------|--------|
| 0432790845 | 1 4.5x8x8 | 04/072 |
| 04312600018 | 2 7x5x4 | 01/096 |



MOLDE
mould molde moule

| REF | (cm) | |
|------------|-------------|--------|
| 0732300030 | 25.2x13x2.5 | 01/500 |



MOLDE
mould molde moule

| REF | (cm) | |
|------------|-----------|--------|
| 0732300051 | 27.3x14x3 | 01/500 |



SIFÃO P/NATAS
cream whipper sifón crema siphon à crème

| REF | (cm) | LT | |
|-------------|---------|-----|--------|
| 0432274325 | Ø8x31.5 | 0.5 | 01/012 |
| 04322743251 | Ø9.5x37 | 1 | 01/012 |





UTENSÍLIOS PASTELARIA

pastry utensils utensilios pastelería ustensiles pâtisserie

8 bicos inox / 8 discos alumínio
8 stainless nozzles / 8 disks aluminum
8 boquillas de acero inoxidable / 8 discos de aluminio
8 buses inox / 8 disques d'aluminium

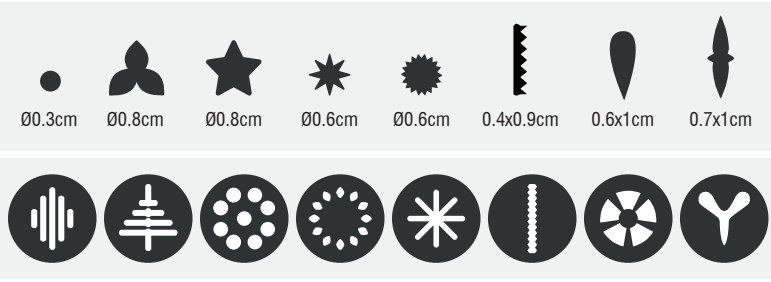

Ø5cm



SERINGA PASTELARIA
pastry syringe jeringa pastelería seringue pâtisserie

| REF | (cm) | |
|-----------|-----------|--------|
| 043360001 | Ø5.5x16.5 | 01/024 |

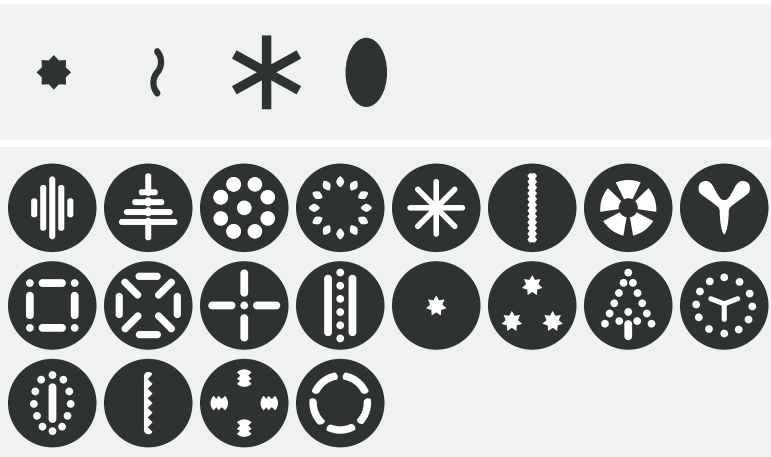

Ø5cm



SERINGA PASTELARIA
pastry syringe jeringa pastelería seringue pâtisserie

| REF | (cm) | |
|-----------|-----------|--------|
| 043360002 | Ø5.5x21.5 | 01/024 |



SACO PASTELEIRO
pastry bag manga pastelera poche pâtisserie

| REF | (cm) | |
|-------------|------|--------|
| 0732300603 | 35 | 01/500 |
| 07323006031 | 40 | 01/500 |
| 07323006032 | 46 | 01/500 |
| 07323006033 | 50 | 01/500 |
| 07323006034 | 55 | 01/250 |
| 07323006035 | 60 | 01/250 |

revestido em pvc pvc coating
revestimiento pvc revêtement pvc



SACO PASTELEIRO
pastry bag manga pastelera poche pâtisserie

| REF | (cm) | |
|-------------|------|--------|
| 04312600163 | 40 | 10/150 |



SACO PASTELEIRO + 6BICOS
pastry bag + 6 tubes
manga pastelera + 6 boquillas
poche pâtisserie + 6 douilles

| REF | (cm) | |
|------------|------|--------|
| 0732301832 | 33 | 01/144 |

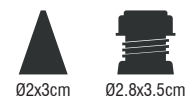
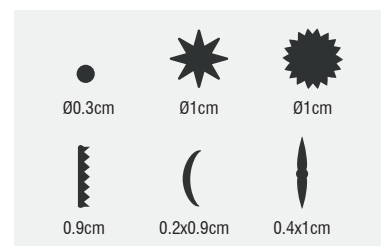



Si
silicone

SACO PASTELEIRO
pastry bag manga pastelera poche pâtisserie

| REF | (cm) | |
|------------|------|--------|
| 0732300006 | 55 | 01/100 |
| 0732300007 | 60 | 01/100 |



PE **PACK 50**

SACO PASTELEIRO DESCARTÁVEL
disposable pastry bag
manga pastelera desechable
poche pâtisserie jetable

| REF | (cm) | |
|------------|------|--------|
| 0732300551 | 28 | 01/100 |



PE **PACK 100**

SACO PASTELEIRO DESCARTÁVEL
disposable pastry bag
manga pastelera desechable
poche pâtisserie jetable

| REF | (cm) | |
|------------|------|--------|
| 0732300605 | 45 | 01/360 |

INOX



CONJUNTO 6 BICOS PASTELEIRO
set 6 tubes conjunto 6 boquillas ensemble 6 douilles

| REF | (cm) | |
|------------|------|--------|
| 0732301803 | - | 01/275 |



INOX



CONJUNTO 3 BICOS PASTELEIRO
set 3 tubes conjunto 3 boquillas ensemble 3 douilles

| REF | (cm) | |
|------------|------|--------|
| 0732301833 | - | 01/500 |

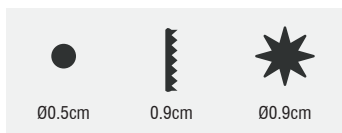

INOX

BICO PASTELEIRO
tube boquilla douille

| REF | (cm) | | |
|-------------|------------|-----|--------|
| 04312600016 | 1 Ø3.5x5 | Nº1 | 10/150 |
| 04312600028 | 2 Ø3.5x5 | Nº2 | 01/150 |
| 04312600033 | 3 Ø3.5x4.5 | Nº3 | 01/150 |
| 0431269004 | 4 Ø3.5x4.5 | Nº4 | 01/150 |
| 04312600053 | 5 Ø3.5x5.5 | Nº5 | 01/150 |
| 04312690064 | 6 Ø3.5x5 | Nº6 | 01/150 |
| 04312600077 | 7 Ø3.5x4 | Nº7 | 01/150 |

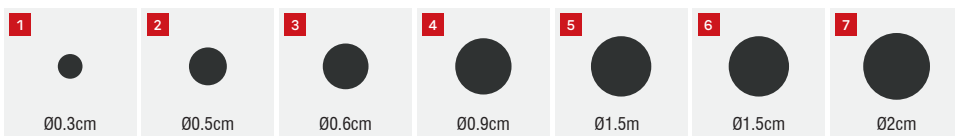

INOX

BICO PASTELEIRO
tube boquilla douille

| REF | (cm) | | |
|-------------|------------|-----|--------|
| 04312600035 | 1 Ø1.8x3.5 | Nº3 | 10/150 |
| 04312600048 | 2 Ø2.8x4 | Nº4 | 10/150 |



INOX

BICO PASTELEIRO
tube boquilla douille

| REF | (cm) | | |
|-------------|----------|------|--------|
| 04312600019 | 1 Ø2x3.7 | Nº19 | 10/150 |
| 04312600087 | 2 Ø3.5x5 | Nº8 | 10/150 |



INOX

BICO PASTELEIRO
tube boquilla douille

| REF | (cm) | | |
|-------------|------------|------|--------|
| 04312600341 | 1 Ø3.5x4.8 | Nº34 | 10/150 |
| 04312600342 | 2 Ø2x2.5 | Nº34 | 10/150 |





UTENSÍLIOS PASTELARIA

pastry utensils utensilios pastelería ustensiles pâtisserie



BICO PASTELEIRO

tube boquilla douille

| REF | (cm) | | |
|-------------|------------|------|--------|
| 04312600461 | 1 Ø2x2.7 | Nº46 | 10/150 |
| 04312600074 | 2 Ø3.5x6.5 | Nº7 | 01/150 |
| 04312600096 | 3 Ø3.5x5.5 | Nº9 | 01/150 |
| 04312600105 | 4 Ø3.5x4.5 | Nº10 | 01/150 |
| 04312600127 | 5 Ø3.5x3.5 | Nº12 | 01/150 |
| 04312600115 | 6 Ø3.5x4 | Nº13 | 01/150 |



BICO PASTELEIRO ROSA

tube boquilla douille

| REF | (cm) | | |
|-------------|------------|-----|--------|
| 04312600059 | 1 Ø3.5x5 | Nº5 | 10/150 |
| 04312690063 | 2 Ø3.5x5 | Nº6 | 01/150 |
| 04312600086 | 3 Ø3.5x5.5 | Nº8 | 01/150 |

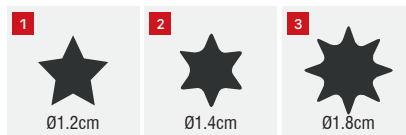

SUPORTE P/SACO E BICOS PASTELEIRO

support for pastry bag and tubes

soporte para manga pastelera y boquillas

support pour poche pâtisserie et douilles

| REF | (cm) | |
|------------|----------|--------|
| 0732301850 | Ø19x21.5 | 01/024 |



CAIXA 16 BICOS PASTELEIRO + 1 ADAPTADOR

box 16 tubes + 1 adapter

caja 16 boquillas + 1 adaptador

boîte 16 douilles + 1 adaptateur

| REF | (cm) | |
|------------|----------|--------|
| 0430682002 | 15x8x4.5 | 01/024 |



CAIXA 23 BICOS PASTELEIRO + 1 ADAPTADOR

box 23 tubes + 1 adapter

caja 23 boquillas + 1 adaptador

boîte 23 douilles + 1 adaptateur

| REF | (cm) | |
|------------|---------------|--------|
| 0732303035 | 16.5x11.5x3.5 | 20/080 |

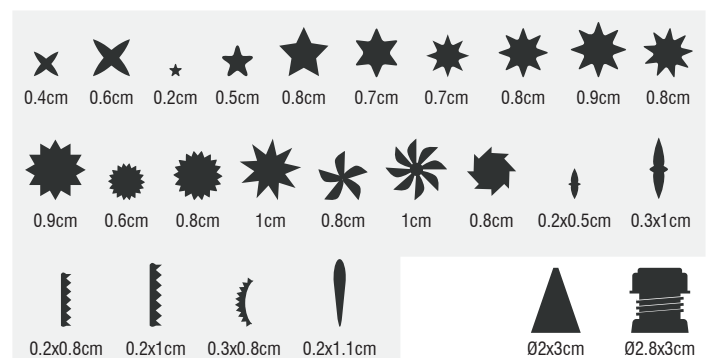
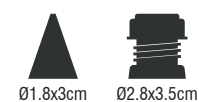
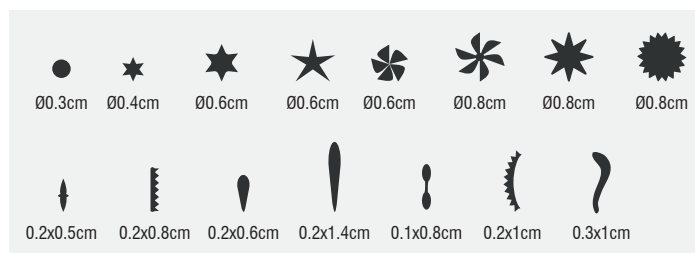



COLHER GELADO

ice cream spoon reccionador de helado cuillère à glace

| REF | (cm) | |
|------------|-----------|--------|
| 0430685104 | 21xØ3.9 | 12/120 |
| 0430685105 | Ø4.4x21.5 | 12/120 |
| 0430685106 | 21.5xØ4.8 | 12/120 |
| 0430685107 | 22xØ5 | 12/120 |
| 0430685109 | 22.5xØ5.3 | 12/120 |
| 0430685113 | 23xØ7 | 12/120 |



COLHER GELADO

ice cream spoon reccionador de helado cuillère à glace

| REF | (cm) | |
|------------|-----------|--------|
| 0434070055 | 22.5xØ5.5 | 01/100 |
| 0434070006 | 23xØ6 | 01/100 |



COLHER GELADO

ice cream spoon reccionador de helado cuillère à glace

| REF | (cm) | |
|------------|---------|--------|
| 0430722006 | 23xØ7.7 | 12/072 |



COLHER GELADO

ice cream spoon reccionador de helado cuillère à glace

| REF | (cm) | |
|------------|-----------|--------|
| 0430722030 | 20.5xØ4.7 | 12/072 |



COLHER GELADO

ice cream spoon reccionador de helado cuillère à glace

| REF | (cm) | |
|------------|--------|--------|
| 0733610128 | 18x4.2 | 01/072 |



COLHER GELADO

ice cream spoon reccionador de helado cuillère à glace

| REF | (cm) | |
|------------|--------|--------|
| 0433518104 | 21x4.5 | 12/048 |



COLHER GELADO

ice cream spoon reccionador de helado cuillère à glace

| REF | (cm) | |
|------------|--------|--------|
| 0430687412 | 25x7.5 | 12/072 |



COLHER GELADO

ice cream spoon reccionador de helado cuillère à glace

| REF | (cm) | |
|------------|--------|--------|
| 0432790714 | 19x4.8 | 06/072 |





RESERVADO



mesa table mesa table



Mesa

table mesa table

101



SERVIÇOS DE MESA

table services servicios de mesa services de table

113



LOUÇA DE SERVIR

tableware vajilla de servir vaisselle à servir

149



TALHERES

cutlery cubiertos coutellerie

NOVO
new

153



CÁLICES/COPOS

tumblers/glasses vasos/tazas verres/tasses

177



UTENSÍLIOS DE SERVIR

serving utensils utensilios para servir ustensiles de service





SERVIÇOS DE MESA

table services servicios de mesa services de table

Linha Óbidos

De formas simples, elegantes e sóbrias, os pratos Óbidos são uma boa solução para a restauração e hotelaria
Resistente ao micro-ondas, forno, frigorífico e máquina de lavar

*In simple, elegant and sober ways, Óbidos dishes are a good solution for catering and hotel business
Resistant to microwave, oven, fridge and dishwasher*

Arquitectura sencilla, elegante y elegante, los platos Óbidos son una buena solución para restaurantes y hoteles
Es resistente al microondas, horno, nevera y lavavajilla

*Architecture simple, élégant et raffiné, les plats Óbidos sont une bonne solution pour les restaurants et les hôtels
Micro-ondes résistant, four, réfrigérateur et lave-linge*



PORCELANA
PORCELAIN
PORCELANA
PORCELAINE

PRATO RASO ÓBIDOS
dinner plate plato llano assiette plate

| REF | (cm) | N° | |
|------------|------|----|--------|
| 0232120000 | Ø27 | 0 | 06/024 |

PORCELANA
PORCELAIN
PORCELANA
PORCELAINE

PRATO RASO ÓBIDOS
dinner plate plato llano assiette plate

| REF | (cm) | N° | |
|------------|-------|----|--------|
| 0232120001 | Ø25.5 | 1 | 06/024 |

PORCELANA
PORCELAIN
PORCELANA
PORCELAINE

PRATO SOPA ÓBIDOS
soup plate plato hondo assiette creuse

| REF | (cm) | CL | N° | |
|-------------|------|----|----|--------|
| 02321200023 | Ø23 | 40 | 2 | 12/024 |

PORCELANA
PORCELAIN
PORCELANA
PORCELAINE

PRATO SOBREMESA ÓBIDOS
dessert plate plato postre assiette à dessert

| REF | (cm) | N° | |
|------------|------|----|--------|
| 0232120003 | Ø20 | 3 | 06/036 |

PORCELANA
PORCELAIN
PORCELANA
PORCELAINE

PRATO DOCE ÓBIDOS
bread & butter plate plato pan assiette à pain

| REF | (cm) | N° | |
|------------|------|----|--------|
| 0232120004 | Ø16 | 4 | 12/072 |

simples
e elegante

simple and elegant
sencillo y elegante
simple et élégant





**Linha
Tokio**



mesa table mesa table



PORCELANA
PORCELAIN
PORCELANA
PORCELAINE

PRATO RASO TOKIO
dinner plate plato llano assiette plate

| REF | (cm) | |
|------------|-------|--------|
| 0230462871 | 25x25 | 06/036 |



PORCELANA
PORCELAIN
PORCELANA
PORCELAINE

PRATO RASO TOKIO
dinner plate plato llano assiette plate

| REF | (cm) | |
|------------|-----------|--------|
| 0230462872 | 23.2x23.2 | 06/036 |



PORCELANA
PORCELAIN
PORCELANA
PORCELAINE

PRATO SOPA TOKIO
soup plate plato hondo assiette creuse

| REF | (cm) | CL | |
|------------|-----------|------|--------|
| 0230464010 | 19.5x19.5 | 25.5 | 06/048 |



PORCELANA
PORCELAIN
PORCELANA
PORCELAINE

PRATO SOBREMESA TOKIO
dessert plate plato postre assiette à dessert

| REF | (cm) | |
|------------|-----------|--------|
| 0230462873 | 19.5x16.5 | 06/048 |



PORCELANA
PORCELAIN
PORCELANA
PORCELAINE

PRATO DOCE TOKIO
bread & butter plate plato pan assiette à pain

| REF | (cm) | |
|------------|-----------|--------|
| 0230462874 | 16.7x16.7 | 12/072 |



PORCELANA
PORCELAIN
PORCELANA
PORCELAINE

SALADEIRA TOKIO
salad bowl ensaladera saladier

| REF | (cm) | CL | |
|------------|-----------|----|--------|
| 0230469464 | 11x11x4.5 | 20 | 01/072 |



PORCELANA
PORCELAIN
PORCELANA
PORCELAINE

PRATO QUADRADO
plate plato assiette

| REF | (cm) | |
|------------|-----------|--------|
| 0230760683 | 31x31x2.5 | 01/012 |



PORCELANA
PORCELAIN
PORCELANA
PORCELAINE

PRATO SOBREMESA
dessert plate plato postre assiette à dessert

| REF | (cm) | |
|------------|-------|--------|
| 0210490019 | 19x19 | 12/048 |



PORCELANA
PORCELAIN
PORCELANA
PORCELAINE

PRATO QUADRADO
plate plato assiette

| REF | (cm) | |
|------------|-----------|--------|
| 0232747157 | 12.5x12.5 | 01/096 |



Linha
Hotel «N»



PORCELANA
PORCELAIN
PORCELANA
PORCELAIN



PRATO RASO HOTEL «N»
dinner plate plato llano assiette plate

| REF | (cm) | N° | |
|------------|------|----|--------|
| 0231722105 | Ø26 | 0 | 00/024 |

PORCELANA
PORCELAIN
PORCELANA
PORCELAIN



PRATO RASO HOTEL «N»
dinner plate plato llano assiette plate

| REF | (cm) | N° | |
|------------|------|----|--------|
| 0231722095 | Ø24 | 1 | 00/036 |

PORCELANA
PORCELAIN
PORCELANA
PORCELAIN



PRATO SOPA HOTEL «N»
soup plate plato hondo assiette creuse

| REF | (cm) | CL | N° | |
|------------|-------|----|----|--------|
| 0231722875 | Ø22.3 | 25 | 2 | 01/072 |

PORCELANA
PORCELAIN
PORCELANA
PORCELAIN



PRATO SOBREMESA HOTEL «N»
dessert plate plato postre assiette à dessert

| REF | (cm) | N° | |
|------------|-------|----|--------|
| 0231722075 | Ø19 | 3 | 00/072 |
| 0231727008 | Ø20.6 | 3 | 01/072 |

PORCELANA
PORCELAIN
PORCELANA
PORCELAIN



PRATO DOCE HOTEL «N»
bread & butter plate plato pan assiette à pain

| REF | (cm) | N° | |
|------------|------|----|--------|
| 0231722065 | Ø16 | 4 | 00/096 |

PORCELANA
PORCELAIN
PORCELANA
PORCELAIN



TRAVESSA OVAL HOTEL
oval platter fuente oval plat à servir oval

| REF | (cm) | |
|-------------|---------|--------|
| 02304600421 | 42x26 | 03/009 |
| 0230460031 | 31.8x21 | 04/012 |
| 0230460028 | 28.5x19 | 06/024 |
| 02304600251 | 25x17 | 06/036 |

PORCELANA
PORCELAIN
PORCELANA
PORCELAIN



TRAVESSA OVAL
oval platter fuente oval plat à servir oval

| REF | (cm) | |
|-------------|-----------|--------|
| 02307632111 | 28x21x2 | 00/036 |
| 02307632113 | 33x25x2.5 | 00/018 |
| 02307632115 | 38x29x3 | 00/018 |

travessa compativel com outros modelos platter compatible with other models
fuente compatible con otros modelos plat à servir compatible avec d'autres modèles



Linha Coupe Hotel

Para quem não tem tempo a perder, a linha COUPE HOTEL, é a solução mais simples e prática.
É versátil e resistente, adaptável a todos os tipos de ambiente.

For those who do not have time to lose, the COUPE HOTEL line is the simplest and most practical solution.
It is versatile and resistant, adaptable to all types of environment.

Para aquellos que no tienen tiempo que perder, la línea COUPE HOTEL, es la solución más sencilla y práctica.
Es versátil y duradero, adaptable a todo tipo de entornos.

Pour ceux qui ont pas de temps à perdre, la ligne COUPÉ HÔTEL, est la solution la plus simple et pratique.
Il est polyvalent et durable, adaptable à tous les types d'environnement.



PORCELANA
PORCELAIN
PORCELANA
PORCELAIN

PRATO RASO COUPE HOTEL
dinner plate plato llano assiette plate

| REF | (cm) | N° | |
|------------|------|----|--------|
| 0231721105 | Ø26 | 0 | 00/024 |



PORCELANA
PORCELAIN
PORCELANA
PORCELAIN

PRATO SOBREMESA COUPE HOTEL
dessert plate plato postre assiette à dessert

| REF | (cm) | N° | |
|------------|------|----|--------|
| 0231721008 | Ø20 | 3 | 00/083 |



PORCELANA
PORCELAIN
PORCELANA
PORCELAIN

PRATO DOCE COUPE HOTEL
bread & butter plate plato pan assiette à pain

| REF | (cm) | N° | |
|------------|------|----|--------|
| 0231721065 | Ø16 | 4 | 00/093 |



PORCELANA
PORCELAIN
PORCELANA
PORCELAIN

PRATO SOPA COUPE HOTEL
soup plate plato hondo assiette creuse

| REF | (cm) | CL | N° | |
|-------------|------|----|----|--------|
| 02317210081 | Ø20 | 70 | 2 | 00/048 |



PORCELANA
PORCELAIN
PORCELANA
PORCELAIN

PRATO FUNDO COUPE
bottom plate plato hondo assiette creuse

| REF | (cm) | CL | |
|------------|------|----|--------|
| 0230468760 | Ø23 | 70 | 04/024 |



PORCELANA
PORCELAIN
PORCELANA
PORCELAIN

PRATO COUPE
plate plato assiette

| REF | (cm) | |
|------------|------|--------|
| 0230460502 | Ø15 | 12/144 |
| 0231720008 | Ø20 | 00/072 |



Linha Lagos

Simple, prático e versátil.
Ideal para refeições criativas e originais.

Simple, practical and versatile.
Ideal for creative and original meals.

Sencillo, práctico y versátil.
Ideal para comidas creativas y originales.

Simple, pratique et polyvalent.
Idéal pour les repas créatifs et originaux.



PORCELANA
PORCELAIN
PORCELANA
PORCELAINE

PRATO RASO LAGOS
dinner plate plato llano assiette plate

| REF | (cm) | N° | |
|------------|------|----|--------|
| 0231530001 | Ø24 | 1 | 06/036 |



PORCELANA
PORCELAIN
PORCELANA
PORCELAINE

PRATO SOBREMESA LAGOS
dessert plate plato postre assiette à dessert

| REF | (cm) | N° | |
|------------|------|----|--------|
| 0231530003 | Ø19 | 3 | 06/072 |



PORCELANA
PORCELAIN
PORCELANA
PORCELAINE

PRATO DOCE LAGOS
bread & butter plate plato pan assiette à pain

| REF | (cm) | N° | |
|------------|------|----|--------|
| 0231530004 | Ø16 | 4 | 06/072 |



PORCELANA
PORCELAIN
PORCELANA
PORCELAINE

PRATO SOPA LAGOS
soup plate plato hondo assiette creuse

| REF | (cm) | CL | N° | |
|------------|------|----|----|--------|
| 0231530002 | Ø21 | 42 | 2 | 06/024 |



PORCELANA
PORCELAIN
PORCELANA
PORCELAINE

PRATO SOPA COMUM
soup plate plato hondo assiette creuse

| REF | (cm) | CL | N° | |
|------------|------|----|----|--------|
| 0231722085 | Ø20 | 50 | 2 | 00/036 |





Linha Snack



PORCELANA
PORCELAIN
PORCELANA
PORCELAINE

PRATO RASO SNACK
dinner plate plato llano assiette plate

| REF | (cm) | N° | |
|------------|-------|----|--------|
| 0232122000 | Ø25.5 | 0 | 06/024 |



PORCELANA
PORCELAIN
PORCELANA
PORCELAINE

PRATO RASO SNACK
dinner plate plato llano assiette plate

| REF | (cm) | N° | |
|------------|-------|----|--------|
| 0232122001 | Ø23.5 | 1 | 06/036 |



PORCELANA
PORCELAIN
PORCELANA
PORCELAINE

PRATO SOBREMESA SNACK
dessert plate plato postre assiette à dessert

| REF | (cm) | N° | |
|------------|-------|----|--------|
| 0232122003 | Ø20.5 | 3 | 06/048 |



PORCELANA
PORCELAIN
PORCELANA
PORCELAINE

PRATO DOCE SNACK
bread & butter plate plato pan assiette à pain

| REF | (cm) | N° | |
|------------|------|----|--------|
| 0232122004 | Ø18 | 4 | 06/048 |
| 0230461004 | Ø17 | 4 | 06/072 |



PORCELANA
PORCELAIN
PORCELANA
PORCELAINE

TRAVESSA OVAL REFORÇADA
oval platter fuente oval plat à servir oval

| REF | (cm) | |
|------------|-------|--------|
| 0230460821 | 23x16 | 06/036 |
| 0230460822 | 25x18 | 06/036 |
| 0230460823 | 30x21 | 04/016 |
| 0230460824 | 35x25 | 04/008 |



PORCELANA
PORCELAIN
PORCELANA
PORCELAINE

TRAVESSA OVAL C/ABA ESTREITA
oval platter fuente oval plat à servir oval

| REF | (cm) | |
|------------|-----------|--------|
| 0231462209 | 33.5x26.5 | 04/016 |



Linha Hotel/Lagos

FILADO AZUL
blue-banded
hilado azul
facette bleue



PORCELANA
PORCELAIN
PORCELANA
PORCELAINE

PRATO RASO HOTEL
dinner plate plato llano assiette plate

| REF | (cm) | N° | |
|------------|------|----|--------|
| 0130460001 | Ø24 | 1 | 12/024 |



PORCELANA
PORCELAIN
PORCELANA
PORCELAINE

PRATO SOPA HOTEL
soup plate plato hondo assiette creuse

| REF | (cm) | CL | N° | |
|------------|------|----|----|--------|
| 0130460002 | Ø22 | 40 | 2 | 12/024 |



PORCELANA
PORCELAIN
PORCELANA
PORCELAINE

PRATO SOBREMESA HOTEL
dessert plate plato postre assiette à dessert

| REF | (cm) | N° | |
|------------|------|----|--------|
| 0130460003 | Ø19 | 3 | 12/024 |



PORCELANA
PORCELAIN
PORCELANA
PORCELAINE

PRATO DOCE HOTEL
bread & butter plate plato pan assiette à pain

| REF | (cm) | N° | |
|------------|------|----|--------|
| 0130460004 | Ø16 | 4 | 12/072 |



PORCELANA
PORCELAIN
PORCELANA
PORCELAINE

PRATO RASO LAGOS
dinner plate plato llano assiette plate

| REF | (cm) | N° | |
|------------|------|----|--------|
| 0231531001 | Ø24 | 1 | 06/024 |



PORCELANA
PORCELAIN
PORCELANA
PORCELAINE

PRATO SOPA LAGOS
soup plate plato hondo assiette creuse

| REF | (cm) | CL | N° | |
|------------|------|----|----|--------|
| 0231531002 | Ø21 | 42 | 2 | 06/024 |



PORCELANA
PORCELAIN
PORCELANA
PORCELAINE

PRATO SOBREMESA LAGOS
dessert plate plato postre assiette à dessert

| REF | (cm) | N° | |
|------------|------|----|--------|
| 0231531003 | Ø19 | 3 | 06/048 |



PORCELANA
PORCELAIN
PORCELANA
PORCELAINE

PRATO DOCE LAGOS
bread & butter plate plato pan assiette à pain

| REF | (cm) | N° | |
|------------|------|----|--------|
| 0231531004 | Ø16 | 4 | 12/072 |

prático
e contemporâneo

practical and contemporary
práctico y contemporáneo
pratique et contemporain



Linha Hotel c/relevo

Modelo clássico, com relevos delicados, é constituído por pratos e travessa. Perfeito para pratos com tradição e história.

Classic model, with delicate reliefs, consists of plates and platter. Perfect for dishes with tradition and history.

Modelo clásico con relieves delicados, se compone de placas y del plato. Perfecto para los platos con tradición e historia.

Modèle classique avec des reliefs délicats, se compose de plaques et plateau. Parfait pour les plats avec la tradition et de l'histoire.



PORCELANA
PORCELAIN
PORCELANA
PORCELAINE

PRATO RASO HOTEL C/RELEVO
dinner plate plato llano assiette plate

| REF | (cm) | N° | |
|------------|------|----|--------|
| 0230212001 | Ø27 | 0 | 06/024 |



PORCELANA
PORCELAIN
PORCELANA
PORCELAINE

PRATO SOPA HOTEL C/RELEVO
soup plate plato hondo assiette creuse

| REF | (cm) | CL | N° | |
|------------|------|------|----|--------|
| 0230212003 | Ø23 | 33.5 | 2 | 06/036 |



PORCELANA
PORCELAIN
PORCELANA
PORCELAINE

PRATO SOBREMESA HOTEL C/RELEVO
soup plate plato hondo assiette creuse

| REF | (cm) | N° | |
|------------|------|----|--------|
| 0230212004 | Ø20 | 3 | 12/048 |



PORCELANA
PORCELAIN
PORCELANA
PORCELAINE

TRAVESSA REFORÇADA HOTEL C/RELEVO
platter reinforced fuente reforzada plat à servir renforcé

| REF | (cm) | |
|------------|-------|--------|
| 0230212006 | 23x14 | 12/048 |
| 0230212005 | 32x22 | 06/024 |





PRATOS DIVERSOS

plates platos assiettes

PRODUTO DESCONTINUADO
DISCONTINUED PRODUCT
PRODUCTO CONTINUADO
PRODUIT DISCONTINUE



PORCELANA
PORCELAIN
PORCELANA
PORCELAINE

PRATO SOPA C/ABA REFORÇADA
soup plate plato hondo assiette creuse

| REF | (cm) | CL | N° | |
|------------|-------|----|----|--------|
| 0230500007 | Ø22.5 | 60 | 2 | 06/036 |



PORCELANA
PORCELAIN
PORCELANA
PORCELAINE

PRATO SOPA REFORÇADO
soup plate plato hondo assiette creuse

| REF | (cm) | CL | N° | |
|------------|------|----|----|--------|
| 0230462002 | Ø23 | 24 | 2 | 06/036 |



PORCELANA
PORCELAIN
PORCELANA
PORCELAINE

PRATO FUNDO
bottom plate plato hondo assiette creuse

| REF | (cm) | CL | |
|------------|-------|----|--------|
| 0230760010 | Ø24.5 | 85 | 00/024 |



prato compatível com outros modelos
plate compatible with other models
plato compatible con otros modelos
plateau compatible avec d'autres modèles



PORCELANA
PORCELAIN
PORCELANA
PORCELAINE

PRATO MEIA LUA P/SALADA
salad plate plato ensaladera assiette à salade

| REF | (cm) | |
|------------|------|--------------------|
| 0220010464 | 1 | 22x17 12/048 |
| 0230463800 | 2 | 20.5x11x2.5 01/050 |



PORCELANA
PORCELAIN
PORCELANA
PORCELAINE

TAÇA
bowl cuenco bol

| REF | (cm) | CL | |
|-------------|-------|----|--------|
| 02307601001 | Ø21x5 | 94 | 01/008 |



PORCELANA
PORCELAIN
PORCELANA
PORCELAINE

PRATO
platter plato assiette

| REF | (cm) | CL | |
|------------|-----------|----|--------|
| 0230760100 | 23x23x4.5 | 70 | 01/008 |



PORCELANA
PORCELAIN
PORCELANA
PORCELAINE

PRATO RECTANGULAR
plate plato assiette

| REF | (cm) | |
|------------|-------|--------|
| 0230766301 | 30x20 | 01/018 |



PORCELANA
PORCELAIN
PORCELANA
PORCELAINE

PRATO RECTANGULAR
plate plato assiette

| REF | (cm) | |
|------------|---------|--------|
| 0232747170 | 20.5x13 | 01/048 |



PORCELANA
PORCELAIN
PORCELANA
PORCELAINE

NOVO
new

PRATO TRIANGULAR
plate plato assiette

| REF | (cm) | |
|------------|---------------|--------|
| 0234110044 | 33.3x18.2x2.3 | 04/024 |



PORCELANA
PORCELAIN
PORCELANA
PORCELAINE

NOVO
new

PRATO TRIANGULAR
plate plato assiette

| REF | (cm) | |
|------------|---------------|--------|
| 0234110052 | 30.5x28.2x2.6 | 04/016 |



PORCELANA
PORCELAIN
PORCELANA
PORCELAINE

NOVO
new

PRATO LÁGRIMA
plate plato assiette

| REF | (cm) | |
|------------|---------------|--------|
| 0234113624 | 29.8x18.5x6.7 | 03/018 |



PORCELANA
PORCELAIN
PORCELANA
PORCELAINE

PRATO PASTA/RISOTTO
plate plato assiette

| REF | (cm) | CL | |
|------------|-----------|----|--------|
| 0230760900 | Ø25.5x4.8 | 18 | 01/012 |
| 0231723105 | Ø27x4.7 | 30 | 01/024 |

PORCELANA
PORCELAIN
PORCELANA
PORCELAINE

PRATO PASTA
pasta plate plato pasta assiette à pasta

| REF | (cm) | CL | |
|------------|-------|----|--------|
| 0232120245 | Ø24.5 | 40 | 06/012 |
| 0232121201 | Ø27 | 60 | 00/006 |
| 0232120601 | Ø30 | 70 | 06/024 |



PORCELANA
PORCELAIN
PORCELANA
PORCELAINE

PRATO PASTA
pasta plate plato pasta assiette à pasta

| REF | (cm) | CL | |
|------------|---------|----|--------|
| 0230760090 | Ø26x4.5 | 50 | 00/016 |



PORCELANA
PORCELAIN
PORCELANA
PORCELAINE

PRATO PASTA
pasta plate plato pasta assiette à pasta

| REF | (cm) | CL | |
|------------|------|----|--------|
| 0232121102 | Ø30 | 80 | 00/006 |



PORCELANA
PORCELAIN
PORCELANA
PORCELAINE

PRATO PASTA
pasta plate plato pasta assiette à pasta

| REF | (cm) | CL | |
|------------|-------|-----|--------|
| 0230461614 | Ø26x5 | 124 | 00/020 |



PORCELANA
PORCELAIN
PORCELANA
PORCELAINE

PRATO PIZZA
pizza plate plato pizza assiette pizza

| REF | (cm) | | |
|------------|------|----------|--------|
| 0232120033 | Ø33 | NOVO new | 00/006 |
| 0232121101 | Ø30 | | 00/006 |



PRATOS DIVERSOS

plates platos assiettes



PORCELANA
PORCELAIN
PORCELANA
PORCELAINE

PRATO PIZZA
pizza plate plato pizza assiette pizza

| REF | (cm) | |
|------------|------|--------|
| 0230761149 | Ø32 | 06/012 |



PORCELANA
PORCELAIN
PORCELANA
PORCELAINE

PRATO PIZZA
pizza plate plato pizza assiette pizza

| REF | (cm) | |
|------------|-------|--------|
| 0230763814 | Ø35.6 | 01/006 |



PORCELANA
PORCELAIN
PORCELANA
PORCELAINE

PRATO OVAL
plate plato assiette

| REF | (cm) | |
|------------|-------|--------|
| 0230761014 | 36x30 | 02/008 |



PORCELANA
PORCELAIN
PORCELANA
PORCELAINE

PRATO MARCADOR
charger plate plato presentation assiette à présentation

| REF | (cm) | |
|------------|------|--------|
| 0232744207 | Ø31 | 01/012 |



PORCELANA
PORCELAIN
PORCELANA
PORCELAINE

PRATO MARCADOR
charger plate plato presentation assiette à présentation

| REF | (cm) | |
|------------|-------|--------|
| 0231721012 | Ø30.7 | 01/024 |



PORCELANA
PORCELAIN
PORCELANA
PORCELAINE

PRATO MARCADOR
charger plate plato presentation assiette à présentation

| REF | (cm) | |
|------------|------|--------|
| 0230460708 | Ø30 | 01/018 |



PORCELANA
PORCELAIN
PORCELANA
PORCELAINE

PRATO MARCADOR
charger plate plato presentation assiette à présentation

| REF | (cm) | |
|-------------|------|--------|
| 02317231051 | Ø28 | 01/036 |



PORCELANA
PORCELAIN
PORCELANA
PORCELAINE

PRATO MARCADOR
charger plate plato presentation assiette à présentation

| REF | (cm) | |
|------------|------|--------|
| 0230463758 | Ø30 | 01/018 |



VIDRO
GLASS
VIDRIO
VERRE

PRATO MARCADOR
charger plate plato presentation assiette à présentation

| REF | (cm) | |
|------------|------|--------|
| 0332850020 | Ø32 | 01/001 |

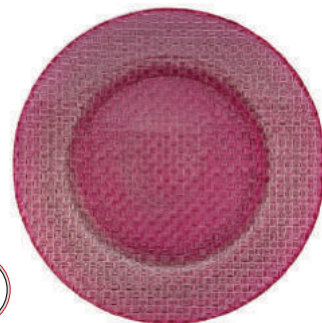

VIDRO
GLASS
VIDRIO
VERRE

PRATO MARCADOR
charger plate plato presentation assiette à apresentação

| REF | (cm) | |
|------------|-------|--------|
| 0337090001 | Ø35.6 | 01/001 |



INOX

PRATO MARCADOR
charger plate plato presentation assiette à apresentação

| REF | (cm) | |
|-------------|------|--------|
| 0432430033 | Ø33 | 01/036 |
| 04324300303 | Ø30 | 01/050 |



LOUÇA DE SERVIR

tableware vajilla de servir vaisselle à servir





LOUÇA DE SERVIR

tableware vajilla de servir vaisselle à servir

mesa table mesa table



PORCELANA
PORCELAIN
PORCELANA
PORCELAINE



ÇAÇAROLA C/TAMPA TOP
casserole cacerola cocotte

| REF | (cm) | CL | |
|------------|----------|-----|--------|
| 0231421000 | Ø7.5x6.5 | 9.8 | 12/108 |

PORCELANA
PORCELAIN
PORCELANA
PORCELAINE



ÇAÇAROLA REDONDA
round casserole cacerola redonda cocotte ronde

| REF | (cm) | CL | |
|------------|----------|-----|--------|
| 0230480362 | Ø18x10.7 | 150 | 01/012 |
| 0230480360 | Ø23.5x13 | 200 | 01/006 |

PORCELANA
PORCELAIN
PORCELANA
PORCELAINE



ÇAÇAROLA REDONDA
round casserole cacerola redonda cocotte ronde

| REF | (cm) | CL | |
|------------|-------|----|--------|
| 0231420919 | Ø16x9 | 60 | 02/024 |
| 0231420906 | Ø12x8 | 25 | 02/024 |



PORCELANA
PORCELAIN
PORCELANA
PORCELAINE

ÇAÇAROLA
casserole cacerola cocotte

| REF | (cm) | CL | |
|------------|---------------|----|--------|
| 0230762491 | 14.8x12.1x8.5 | 45 | 00/036 |

PORCELANA
PORCELAIN
PORCELANA
PORCELAINE



ÇAÇAROLA
casserole cacerola cocotte

| REF | (cm) | CL | |
|------------|-------------|-----|--------|
| 0230760244 | 21x17.5x8.5 | 132 | 01/012 |



PORCELANA
PORCELAIN
PORCELANA
PORCELAINE

MINI ÇAÇAROLA
casserole cacerola cocotte

| REF | (cm) | CL | |
|---------------------|---------------|----|--------|
| 0233917467 1 | 11x9.2x8 | 20 | 00/048 |
| 0233917466 2 | 13.7x11.4x8.5 | 26 | 00/048 |

PORCELANA
PORCELAIN
PORCELANA
PORCELAINE



FRIGIDEIRA C/ASAS
augratin plato gratinados plat à gratin

| REF | (cm) | CL | |
|-------------|---------|------|--------|
| 0230460006 | Ø17x3.2 | 40 | 01/072 |
| 02304600089 | Ø20x3.5 | 60 | 01/048 |
| 0230460009 | Ø22x3.5 | 72.5 | 01/036 |

PORCELANA
PORCELAIN
PORCELANA
PORCELAINE



FRIGIDEIRA C/ASAS
augratin plato gratinados plat à gratin

| REF | (cm) | CL | |
|------------|---------------|----|--------|
| 0232745714 | 16.3x13x2.5 | 20 | 06/072 |
| 0232745713 | 19.7x16x3.5 | 30 | 06/048 |
| 0232745712 | 25.7x20.3x4.5 | 73 | 06/048 |



PORCELANA
PORCELAIN
PORCELANA
PORCELAINE

FRIGIDEIRA C/ASAS
augratin plato gratinados plat à gratin

| REF | (cm) | CL | |
|------------|-----------|----|--------|
| 0230760710 | 27x21x5.5 | 71 | 00/018 |



PORCELANA
PORCELAIN
PORCELANA
PORCELAINE

FRIGIDEIRA C/ASAS
augratin plato gratinados plat à gratin

| REF | (cm) | CL | |
|------------|---------|----|--------|
| 0230765110 | Ø22x4.3 | 60 | 03/018 |



PORCELANA
PORCELAIN
PORCELANA
PORCELAINE

FRIGIDEIRA C/ASAS
augratin plato gratinados plat à gratin

| REF | (cm) | CL | |
|------------|-------|------|--------|
| 0230500023 | 24x13 | 38 | 06/024 |
| 0230500025 | 31x16 | 95.5 | 06/024 |



PORCELANA
PORCELAIN
PORCELANA
PORCELAINE

ASSADEIRA
roaster fuente plat à four

| REF | (cm) | CL | |
|------------|-----------|------|--------|
| 0233917463 | 21.6x16x5 | 81.5 | 00/016 |



PORCELANA
PORCELAIN
PORCELANA
PORCELAINE

ASSADEIRA
roaster fuente plat à four

| REF | (cm) | CL | |
|------------|-------------|-----|--------|
| 0233917465 | 27x14.8x5.1 | 110 | 00/012 |



PORCELANA
PORCELAIN
PORCELANA
PORCELAINE

ASSADEIRA
roaster fuente plat à four

| REF | (cm) | CL | |
|-------------|-------------|-----|--------|
| 0233917464 | 20.3x16.4x5 | 60 | 00/012 |
| 02339174641 | 26x20.3x5.8 | 110 | 00/024 |



PORCELANA
PORCELAIN
PORCELANA
PORCELAINE

ASSADEIRA
roaster fuente plat à four

| REF | (cm) | CL | |
|------------|-----------|-----|--------|
| 0210219663 | 28x18x5.5 | 115 | 01/012 |
| 0210219664 | 32x20x6 | 150 | 01/006 |

suporte em inox stainless steel support
soporte de acero inoxidable support en acier inoxydable



PORCELANA
PORCELAIN
PORCELANA
PORCELAINE

ASSADEIRA
roaster fuente plat à four

| REF | (cm) | CL | |
|------------|---------|------|--------|
| 0231462234 | 23x12x4 | 42.5 | 06/048 |



PORCELANA
PORCELAIN
PORCELANA
PORCELAINE

ASSADEIRA
roaster fuente plat à four

| REF | (cm) | CL | |
|-------------|-----------|----|--------|
| 02304600091 | 23x13.5x5 | 60 | 06/048 |



PORCELANA
PORCELAIN
PORCELANA
PORCELAINE

ASSADEIRA
roaster fuente plat à four

| REF | (cm) | CL | |
|------------|-----------|----|--------|
| 0230532839 | 18x15x3.7 | 50 | 02/032 |



PORCELANA
PORCELAIN
PORCELANA
PORCELAINE

ASSADEIRA
roaster fuente plat à four

| REF | (cm) | CL | |
|------------|-------|-----|--------|
| 0230500008 | 32x20 | 142 | 03/012 |



PORCELANA
PORCELAIN
PORCELANA
PORCELAINE

TARTEIRA
pie dish tartera tourtière

| REF | (cm) | CL | |
|------------|-------------|-----|--------|
| 0232744244 | 1 Ø12.3x2.5 | 90 | 06/072 |
| 0231463146 | 2 Ø24x3.5 | 162 | 06/024 |



PORCELANA
PORCELAIN
PORCELANA
PORCELAIN

TRAVESSA
platter fuente plat à servir

| REF | (cm) | |
|------------|-------|--------|
| 0230465097 | 54x21 | 04/016 |



PORCELANA
PORCELAIN
PORCELANA
PORCELAIN

TRAVESSA
platter fuente plat à servir

| REF | (cm) | |
|------------|-----------|--------|
| 0230762118 | 47x18.5 | 02/012 |
| 0230762122 | 57.7x22.2 | 01/008 |



PORCELANA
PORCELAIN
PORCELANA
PORCELAIN

TRAVESSA P/PEIXE
platter fuente plat à servir

| REF | (cm) | |
|------------|-----------|--------|
| 0230761920 | 51x22 | 01/006 |
| 0230761922 | 57.5x25.6 | 01/004 |



PORCELANA
PORCELAIN
PORCELANA
PORCELAIN

TRAVESSA OVAL
platter fuente plat à servir

| REF | (cm) | |
|------------|-----------|--------|
| 0230761113 | 33x23.6x3 | 01/012 |
| 0230761114 | 37x26x3 | 01/008 |
| 0230761117 | 43x30x3 | 01/008 |



PORCELANA
PORCELAIN
PORCELANA
PORCELAIN

TRAVESSA
platter fuente plat à servir

| REF | (cm) | |
|------------|-----------|--------|
| 0230464570 | 48x21x5.5 | 03/018 |



PORCELANA
PORCELAIN
PORCELANA
PORCELAIN

TRAVESSA OVAL
platter fuente plat à servir

| REF | (cm) | |
|-------------|-----------|--------|
| 02307603782 | 29x21x2.5 | 00/016 |
| 02307603781 | 35x25x2.8 | 00/012 |
| 0230760378 | 38x27x3 | 00/012 |



PORCELANA
PORCELAIN
PORCELANA
PORCELAIN

TRAVESSA OVAL
platter fuente plat à servir

| REF | (cm) | |
|-------------|-----------|--------|
| 02307698713 | 33x25x4 | 00/012 |
| 02307698715 | 37x28x4.2 | 00/012 |
| 02307698717 | 43x32x4.5 | 00/006 |

PORCELANA
PORCELAIN
PORCELANA
PORCELAINE



TRAVESSA
platter fuente plat à servir

| REF | (cm) | |
|------------|-------|--------|
| 0230460060 | 25x17 | 12/024 |
| 0230760060 | 25x17 | 06/024 |
| 0230460042 | 30x20 | 05/015 |
| 0230550061 | 34x23 | 01/024 |
| 0230760061 | 34x23 | 01/012 |

PORCELANA
PORCELAIN
PORCELANA
PORCELAINE



TRAVESSA
platter fuente plat à servir

| REF | (cm) | |
|------------|---------|--------|
| 0231400035 | 36x27x4 | 06/012 |

PORCELANA
PORCELAIN
PORCELANA
PORCELAINE



TRAVESSA
platter fuente plat à servir

| REF | (cm) | |
|------------|---------|--------|
| 0230764114 | 28x19x2 | 00/030 |

PORCELANA
PORCELAIN
PORCELANA
PORCELAINE



TRAVESSA
platter fuente plat à servir

| REF | (cm) | |
|------------|---------|--------|
| 0232743437 | 31x24x3 | 01/020 |

PORCELANA
PORCELAIN
PORCELANA
PORCELAINE



TRAVESSA
platter fuente plat à servir

| REF | (cm) | |
|------------|---------|--------|
| 0232744222 | 35x26x3 | 01/012 |

PORCELANA
PORCELAIN
PORCELANA
PORCELAINE



TRAVESSA
platter fuente plat à servir

| REF | (cm) | |
|------------|-----------|--------|
| 0232743148 | 32.5x20.5 | 01/016 |



PORCELANA
PORCELAIN
PORCELANA
PORCELAINE



TRAVESSA
platter fuente plat à servir

| REF | (cm) | |
|------------|-------|--------|
| 0230776099 | 30x21 | 06/036 |

PORCELANA
PORCELAIN
PORCELANA
PORCELAINE



TRAVESSA (PRATO FEITO)
platter fuente plat à servir

| REF | (cm) | |
|------------|---------|--------|
| 0230460030 | 31x23.5 | 06/036 |

PORCELANA
PORCELAIN
PORCELANA
PORCELAINE



TRAVESSA HOSPITAL
platter fuente plat à servir

| REF | (cm) | |
|------------|---------|--------|
| 0230460071 | 24x19.5 | 01/048 |

PORCELANA
PORCELAIN
PORCELANA
PORCELAINE



TRAVESSA OVAL
platter fuente plat à servir

| REF | (cm) | |
|-------------|------------|--------|
| 02102199232 | 23x16 | 12/048 |
| 0210490012 | 31x22 | 06/024 |
| 0210490014 | 35.5x 24.5 | 06/018 |



PORCELANA
PORCELAIN
PORCELANA
PORCELAINE



TORTEIRA
tart tray bandeja torta plat à cake

| REF | (cm) | |
|-------------|-----------|--------|
| 0230760737 | 35.5x16.5 | 06/024 |
| 02307607371 | 40.5x20 | 06/018 |

PORCELANA
PORCELAIN
PORCELANA
PORCELAINE



TORTEIRA
tart tray bandeja torta plat à cake

| REF | (cm) | |
|------------|-------|--------|
| 0211049999 | 36x15 | 04/016 |



mesa table mesa table



SUSHI



conceito de beleza e criatividade

beauty concept and creativity
concepto de belleza y la creatividad
concept de la beauté et la créativité



PORCELANA
PORCELAIN
PORCELAINA
PORCELAINE

TRAVESSA BARCO
platter fuente plat à servir

| REF | (cm) | |
|------------|---------|--------|
| 0230760619 | 26x16x7 | 00/012 |



PORCELANA
PORCELAIN
PORCELAINA
PORCELAINE

TRAVESSA EXPOSITORA
platter fuente plat à servir

| REF | (cm) | |
|-------------|---------------|--------|
| 02307601841 | 31.7x17.3x4.1 | 00/024 |
| 0230760184 | 35.6x19.5x4.8 | 00/016 |
| 02307601842 | 41x22x4.5 | 00/012 |



PORCELANA
PORCELAIN
PORCELAINA
PORCELAINE

TRAVESSA
platter fuente plat à servir

| REF | (cm) | |
|------------|---------|--------|
| 0230761431 | 39x24x2 | 01/012 |



PORCELANA
PORCELAIN
PORCELAINA
PORCELAINE

TRAVESSA (SUSHI)
platter fuente plat à servir

| REF | (cm) | |
|-------------|---------|--------|
| 02307651101 | 34x12.8 | 06/018 |



PORCELANA
PORCELAIN
PORCELAINA
PORCELAINE

TRAVESSA (SUSHI)
platter fuente plat à servir

| REF | (cm) | |
|------------|---------|--------|
| 0230763111 | 29.8x15 | 04/024 |



PORCELANA
PORCELAIN
PORCELAINA
PORCELAINE

TRAVESSA (SUSHI)
platter fuente plat à servir

| REF | (cm) | |
|-------------|---------|--------|
| 0230760754 | 20x8.5 | 06/072 |
| 02307607541 | 28x11.5 | 06/024 |
| 02307607542 | 32x14 | 06/018 |



PORCELANA
PORCELAIN
PORCELAINA
PORCELAINE

TRAVESSA (SUSHI)
platter fuente plat à servir

| REF | (cm) | |
|------------|----------|--------|
| 0230760015 | 22.2x6.5 | 06/072 |



PORCELANA
PORCELAIN
PORCELAINA
PORCELAINE

TRAVESSA
platter fuente plat à servir

| REF | (cm) | |
|------------|-------------|--------|
| 0230760115 | 26x16.3x1.6 | 06/036 |



PORCELANA
PORCELAIN
PORCELANA
PORCELAINE

**NOVO
new**

TRAVESSA RECTANGULAR
platter fuente plat à servir

| REF | (cm) | |
|------------|-------------|--------|
| 0234112804 | 26.6x15.4x2 | 06/036 |



PORCELANA
PORCELAIN
PORCELANA
PORCELAINE

**NOVO
new**

TRAVESSA OVAL
platter fuente plat à servir

| REF | (cm) | |
|------------|-------------|--------|
| 0234110031 | 33x16.6x2.8 | 04/024 |



PORCELANA
PORCELAIN
PORCELANA
PORCELAINE

**NOVO
new**

TRAVESSA TRIANGULAR
platter fuente plat à servir

| REF | (cm) | |
|------------|---------------|--------|
| 0234110070 | 16.5x12.5x4.6 | 06/048 |
| 0234110071 | 22.2x16.5x5.8 | 04/024 |
| 0234110072 | 26.7x20.3x6.5 | 03/018 |



PORCELANA
PORCELAIN
PORCELANA
PORCELAINE

TRAVESSA OVAL
platter fuente plat à servir

| REF | (cm) | |
|------------|---------------|--------|
| 0230768088 | 26.2x10.8x6.5 | 01/024 |



PORCELANA
PORCELAIN
PORCELANA
PORCELAINE

TRAVESSA OVAL
platter fuente plat à servir

| REF | (cm) | |
|------------|-----------|--------|
| 0230460321 | 30.5x22x4 | 01/036 |



PORCELANA
PORCELAIN
PORCELANA
PORCELAINE

TRAVESSA OVAL
platter fuente plat à servir

| REF | (cm) | |
|------------|-----------|--------|
| 0230465082 | 31x19x4.2 | 01/024 |



PORCELANA
PORCELAIN
PORCELANA
PORCELAINE

TRAVESSA FOLHA
platter fuente plat à servir

| REF | (cm) | |
|------------|-------------|--------|
| 0230460193 | 36.1x17x6.8 | 01/024 |



PORCELANA
PORCELAIN
PORCELANA
PORCELAINE

TRAVESSA RECTANGULAR
platter fuente plat à servir

| REF | (cm) | |
|------------|---------------|--------|
| 0230467792 | 21x11.2x3.5 | 01/036 |
| 0230467793 | 26.3x14.2x3.5 | 01/012 |



PORCELANA
PORCELAIN
PORCELANA
PORCELAINE

TRAVESSA RECTANGULAR
platter fuente plat à servir

| REF | (cm) | CL | |
|-------------|-----------|------|--------|
| 02307601143 | 21x12.8x3 | 42.5 | 06/048 |



1



2

PORCELANA
PORCELAIN
PORCELANA
PORCELAINE

TRAVESSA RECTANGULAR
platter fuente plat à servir

| REF | (cm) | CL | |
|------------|--------------|----|--------|
| 0230760405 | 18x10x3 | 27 | 06/048 |
| 0232746029 | 16.3x9.6x3.3 | 20 | 06/072 |



PORCELANA
PORCELAIN
PORCELANA
PORCELAINE

TRAVESSA
platter fuente plat à servir

| REF | (cm) | CL | |
|-------------|---------------|----|--------|
| 02307601142 | 12x5x2.2 | 4 | 12/144 |
| 0230760114 | 24x11.5x4 | 40 | 01/036 |
| 02307601141 | 31.7x13.4x3.9 | 70 | 04/024 |



LOUÇA DE SERVIR

tableware vajilla de servir vaisselle à servir

mesa table mesa table



PORCELANA
PORCELAIN
PORCELANA
PORCELAINE

SALADEIRA REDONDA
salad bowl ensaladera saladier

| REF | (cm) | CL | |
|------------|-----------|----|--------|
| 0230765127 | Ø18.2x5.5 | 75 | 06/024 |



PORCELANA
PORCELAIN
PORCELANA
PORCELAINE

SALADEIRA REDONDA
salad bowl ensaladera saladier

| REF | (cm) | CL | |
|------------|-----------|-----|--------|
| 0230641511 | Ø26.5x8.5 | 194 | 02/008 |



empilhável
stackable
apilable
empilable



PORCELANA
PORCELAIN
PORCELANA
PORCELAINE

SALADEIRA REDONDA
salad bowl ensaladera saladier

| REF | (cm) | CL | |
|-------------|-----------|----|--------|
| 0231400106 | Ø11.5x3.5 | 12 | 01/096 |
| 02314001061 | Ø16x5 | 50 | 01/048 |



PORCELANA
PORCELAIN
PORCELANA
PORCELAINE

SALADEIRA REDONDA
salad bowl ensaladera saladier

| REF | (cm) | CL | |
|------------|-----------|----|--------|
| 0231720005 | Ø12.7x4.3 | 22 | 12/144 |
| 0231720006 | Ø15.2x5 | 35 | 12/096 |
| 0231720007 | Ø17.8x5.8 | 53 | 12/072 |



PORCELANA
PORCELAIN
PORCELANA
PORCELAINE

SALADEIRA RECTANGULAR
salad bowl ensaladera saladier

| REF | (cm) | CL | |
|------------|-------|------|--------|
| 0230845014 | 14x10 | 20 | 01/012 |
| 0230845017 | 14x12 | 32.5 | 01/012 |



PORCELANA
PORCELAIN
PORCELANA
PORCELAINE

SALADEIRA RECTANGULAR
salad bowl ensaladera saladier

| REF | (cm) | CL | |
|-------------|-----------|----|--------|
| 02307604041 | 15x10x5.5 | 42 | 06/048 |



PORCELANA
PORCELAIN
PORCELANA
PORCELAINE

SALADEIRA OVAL
salad bowl ensaladera saladier

| REF | (cm) | CL | |
|------------|-----------|----|--------|
| 0230760111 | 16x10.5x5 | 40 | 01/048 |



PORCELANA
PORCELAIN
PORCELANA
PORCELAINE

SALADEIRA
salad bowl ensaladera saladier

| REF | (cm) | CL | |
|------------|-------------|------|--------|
| 0232745838 | 16.5x16.5x7 | 62.5 | 05/030 |



PORCELANA
PORCELAIN
PORCELANA
PORCELAINE

TIGELA
bowl bol bol

| REF | (cm) | CL | |
|------------|-----------|----|--------|
| 0230450146 | Ø13.5x7.9 | 68 | 00/048 |



PORCELANA
PORCELAIN
PORCELANA
PORCELAINE

TIGELA
bowl bol bol

| REF | (cm) | CL | |
|------------|-----------|----|--------|
| 0233911117 | Ø18.5x8.3 | - | 01/016 |



PORCELANA
PORCELAIN
PORCELANA
PORCELAINE

TIGELA MULTIUSOS
bowl bol bol

| REF | (cm) | CL | |
|------------|-------|-----|--------|
| 0230468627 | Ø18x9 | 100 | 06/048 |



PORCELANA
PORCELAIN
PORCELANA
PORCELAINE

TIGELA CEREAIS/MULTIUSOS
bowl bol bol

| REF | (cm) | CL | |
|------------|---------|----|--------|
| 0230760050 | Ø13x5.7 | 40 | 06/048 |
| 0230450100 | Ø14x6 | 55 | 00/048 |



PORCELANA
PORCELAIN
PORCELANA
PORCELAINE

TAÇA DE CEREAIS
bowl bol bol

| REF | (cm) | |
|------------|---------|--------|
| 0230460050 | Ø13x5.8 | 06/048 |



PORCELANA
PORCELAIN
PORCELANA
PORCELAINE

TIGELA RIBEIRO
bowl bol bol

| REF | (cm) | CL | |
|------------|-------|----|--------|
| 0231420001 | Ø10x5 | 14 | 12/144 |



PORCELANA
PORCELAIN
PORCELANA
PORCELAINE

TIGELA
bowl bol bol



| REF | (cm) | CL | |
|-------------|---------|------|--------|
| 0230462018 | Ø14x8 | 50 | 06/048 |
| 02304620181 | Ø13x7.5 | 36.5 | 06/048 |



PORCELANA
PORCELAIN
PORCELANA
PORCELAINE

TIGELA
bowl bol bol

| REF | (cm) | CL | |
|------------|---------|----|--------|
| 0210490055 | Ø14x7.5 | 54 | 06/036 |



PORCELANA
PORCELAIN
PORCELANA
PORCELAINE

TIGELA
bowl bol bol

| REF | (cm) | CL | |
|------------|---------|------|--------|
| 0230460828 | Ø17.5x7 | 78.5 | 04/024 |



PORCELANA
PORCELAIN
PORCELANA
PORCELAINE

TIGELA EMPILHÁVEL
bowl bol bol

| REF | (cm) | |
|------------|---------|--------|
| 0234110182 | 6.6x2.5 | 24/384 |

NOVO
new



empilhável
stackable
apilable
empilable



PORCELANA
PORCELAIN
PORCELANA
PORCELAINE

TIGELA SNACK
bowl bol bol

| REF | (cm) | CL | |
|------------|---------|----|--------|
| 0230460051 | Ø11.5x6 | 40 | 01/048 |
| 0230460052 | Ø12.5x7 | 53 | 06/048 |



empilhável
stackable
apilable
empilable



PORCELANA
PORCELAIN
PORCELANA
PORCELAINE

TAÇA SOBREMESA
bowl bol bol

| REF | (cm) | CL | |
|------------|-----------|----|--------|
| 0230460601 | Ø10.5x3.5 | 15 | 12/120 |



empilhável
stackable
apilable
empilable



PORCELANA
PORCELAIN
PORCELANA
PORCELAINE

empilhável
stackable
apilable
empilable

TIGELA
bowl bol bol

| REF | (cm) | CL | |
|------------|---------|------|--------|
| 0230460461 | Ø12x7.5 | 41.5 | 01/048 |



PORCELANA
PORCELAIN
PORCELANA
PORCELAINE

**NOVO
new**

TIGELA
bowl bol bol

| REF | (cm) | |
|------------|---------------|--------|
| 0234110013 | 13.2x12.1x5.5 | 06/060 |



PORCELANA
PORCELAIN
PORCELANA
PORCELAINE

**NOVO
new**

TIGELA
bowl bol bol

| REF | (cm) | |
|------------|--------|--------|
| 0234114095 | 12x4.1 | 06/072 |



PORCELANA
PORCELAIN
PORCELANA
PORCELAINE

**NOVO
new**



TIGELA
bowl bol bol

| REF | (cm) | |
|------------|-------|--------|
| 0234114380 | 9x3.2 | 12/144 |



PORCELANA
PORCELAIN
PORCELANA
PORCELAINE

TAÇA REDONDA
bowl bol bol

| REF | (cm) | CL | |
|-------------|----------|-----|--------|
| 0230760112 | Ø5.8x3.2 | 5 | 12/144 |
| 02307601121 | Ø7x4 | 7.8 | 12/144 |



PORCELANA
PORCELAIN
PORCELANA
PORCELAINE

TAÇA REDONDA
bowl bol bol

| REF | (cm) | CL | |
|------------|----------|-----|--------|
| 0232747180 | Ø6.3x4.5 | 6.3 | 01/184 |



PORCELANA
PORCELAIN
PORCELANA
PORCELAINE

TAÇA CÓNICA
bowl bol bol

| REF | (cm) | CL | |
|------------|-----------|------|--------|
| 0230531959 | Ø10x4.5 | 16 | 06/108 |
| 0230531449 | Ø11.5x6.5 | 25.5 | 06/096 |



PORCELANA
PORCELAIN
PORCELANA
PORCELAINE

TAÇA CILÍNDRICA
bowl bol bol

| REF | (cm) | CL | |
|------------|--------|----|--------|
| 0232745890 | Ø7.4x5 | 14 | 10/120 |
| 0230463061 | Ø9x5.5 | 20 | 12/144 |



PORCELANA
PORCELAIN
PORCELANA
PORCELAINE

TIGELA
bowl bol bol

| REF | (cm) | CL | |
|------------|-----------|----|--------|
| 0230760041 | 15x13x7.5 | 50 | 01/036 |



PORCELANA
PORCELAIN
PORCELANA
PORCELAINE

TAÇA
bowl bol bol

| REF | (cm) | CL | |
|-------------|-------|-----|--------|
| 0210760108 | 6x5 | 1.7 | 24/288 |
| 02107601081 | 10x9 | 12 | 06/072 |
| 02107601082 | 17x14 | 50 | 04/024 |



PORCELANA
PORCELAIN
PORCELANA
PORCELAINE



TAÇA LÁGRIMA
bowl bol bol

| REF | (cm) | CL | |
|------------|----------|----|--------|
| 0230760995 | 10x7.5x4 | 10 | 12/144 |

PORCELANA
PORCELAIN
PORCELANA
PORCELAINE



TAÇA GOTA
bowl bol bol

| REF | (cm) | CL | |
|------------|------------|----|--------|
| 0232744263 | 10x7.5x4.2 | 10 | 01/096 |

PORCELANA
PORCELAIN
PORCELANA
PORCELAINE



CADINHO
bowl bol bol

| REF | (cm) | CL | |
|------------|-----------|----|--------|
| 0232745743 | 8.3x7x4.6 | 10 | 10/120 |

PORCELANA
PORCELAIN
PORCELANA
PORCELAINE



TAÇA
bowl bol bol

| REF | (cm) | CL | |
|------------|-----------|-----|--------|
| 0230760523 | 9.5x8x3.5 | 6.5 | 12/144 |

PORCELANA
PORCELAIN
PORCELANA
PORCELAINE



TAÇA
bowl bol bol

| REF | (cm) | CL | |
|------------|--------|-----|--------|
| 0232747179 | Ø8.5x4 | 8.7 | 01/096 |

PORCELANA
PORCELAIN
PORCELANA
PORCELAINE



TAÇA ONZA
bowl bol bol

| REF | (cm) | CL | |
|------------|-------|----|--------|
| 0230532050 | 6.5x5 | 6 | 12/216 |



PORCELANA
PORCELAIN
PORCELANA
PORCELAINE

TAÇA GOURMET
bowl bol bol

| REF | (cm) | CL | |
|------------|--------|------|--------|
| 0230760278 | 10x9x6 | 16.5 | 12/072 |

PORCELANA
PORCELAIN
PORCELANA
PORCELAINE

**NOVO
new**



TAÇA GOURMET
bowl bol bol

| REF | (cm) | |
|------------|------------|--------|
| 0234110360 | 10x7.2x4.3 | 12/144 |

1



3



2



PORCELANA
PORCELAIN
PORCELANA
PORCELAINE

TAÇA QUADRADA
bowl bol bol

| REF | (cm) | CL | |
|------------|---------------|-----|--------|
| 0232745051 | 1 4.5x4.5x3 | 9.2 | 01/240 |
| 0232744242 | 2 9.2x9.2x5.5 | 20 | 08/096 |
| 0230760684 | 2 8.5x8.5x5.5 | 20 | 12/096 |

1



2



PORCELANA
PORCELAIN
PORCELANA
PORCELAINE

TAÇA QUADRADA
bowl bol bol

| REF | (cm) | CL | |
|------------|-------------|----|--------|
| 0232745998 | 1 10x10x4.3 | 26 | 08/072 |
| 0232744845 | 2 14x14x6.7 | 50 | 06/036 |



PORCELANA
PORCELAIN
PORCELANA
PORCELAINE

TAÇA QUADRADA

bolwl bol bol

| REF | (cm) | CL | |
|------------|-----------------|-----|--------|
| 0232740042 | 1 8.5x8.5x3.3 | 10 | 06/069 |
| 0232740697 | 2 8.5x8.5x3.5 | 6.5 | 10/120 |
| 0232743791 | 3 11.5x11.5x3.5 | 20 | 01/016 |



PORCELANA
PORCELAIN
PORCELANA
PORCELAINE

TAÇA QUADRADA

bolwl bol bol

| REF | (cm) | CL | |
|------------|---------|----|--------|
| 0230768335 | 9x9x5.9 | | 06/072 |



PORCELANA
PORCELAIN
PORCELANA
PORCELAINE

TAÇA CÚBICA

bolwl bol bol

| REF | (cm) | CL | |
|------------|---------------|-----|--------|
| 0230532085 | 1 4x4x2.7 | 1.5 | 24/384 |
| 0230532795 | 2 8.5x8.5x3.5 | 10 | 06/144 |
| 0230532416 | 3 9x9x5 | 20 | 06/096 |



PORCELANA
PORCELAIN
PORCELANA
PORCELAINE

TAÇA QUADRADA

bolwl bol bol

| REF | (cm) | CL | |
|------------|---------------|------|--------|
| 0230765123 | 2 8.6x8.6x4.3 | 14.5 | 06/072 |



PORCELANA
PORCELAIN
PORCELANA
PORCELAINE

TAÇA QUADRADA

bolwl bol bol

| REF | (cm) | CL | |
|-------------|---------------|------|--------|
| 0230760113 | 8x8x2.5 | 8 | 12/144 |
| 02307601131 | 8.7x8.7x3.6 | 10 | 12/144 |
| 02307601132 | 10.7x10.7x4.5 | 25.3 | 06/072 |



PORCELANA
PORCELAIN
PORCELANA
PORCELAINE

TAÇA QUADRADA

bolwl bol bol

| REF | (cm) | CL | |
|------------|---------------|----|--------|
| 0230531439 | 1 8.6x8.6x5.9 | 20 | 06/108 |
| 0232745851 | 2 5.8x5.8x3 | 4 | 20/240 |



PORCELANA
PORCELAIN
PORCELANA
PORCELAINE



TAÇA QUADRADA TOP

bowl bol bol

| REF | (cm) | |
|------------|---------|--------|
| 0231427186 | 6x6x3.8 | 12/288 |

PORCELANA
PORCELAIN
PORCELANA
PORCELAINE



TAÇA QUADRADA

bowl bol bol

| REF | (cm) | CL | |
|------------|------|-----------|------------|
| 0232747186 | 1 | 6x6x3.5 | 3.3 01/240 |
| 0230532051 | 2 | 5.7x5.7x3 | 3 08/256 |

PORCELANA
PORCELAIN
PORCELANA
PORCELAINE

**NOVO
new**



TAÇA TRIANGULAR

bowl bol bol

| REF | (cm) | |
|------------|-------------|--------|
| 0234110053 | 12.1x11x4.2 | 12/072 |

PORCELANA
PORCELAIN
PORCELANA
PORCELAINE



TRAVESSA RECTANGULAR

platter fuente plat à servir

| REF | (cm) | CL | |
|------------|------------|----|--------|
| 0232740700 | 13x8.5x3.6 | 20 | 06/072 |

PORCELANA
PORCELAIN
PORCELANA
PORCELAINE



TAÇA RECTANGULAR

bowl bol bol

| REF | (cm) | CL | |
|------------|------|------------|-----------|
| 0230532417 | 1 | 13x6.8x3 | 13 06/108 |
| 0232740686 | 2 | 12.4x8.7x4 | 20 06/072 |

PORCELANA
PORCELAIN
PORCELANA
PORCELAINE



TAÇA RECTANGULAR

bowl bol bol

| REF | (cm) | CL | |
|------------|--------------|----|--------|
| 0232740701 | 13.7x8.5x3.5 | 20 | 06/072 |

empilhável
stackable
apilable
empilable



PORCELANA
PORCELAIN
PORCELANA
PORCELAINE



TAÇA RECTANGULAR

bowl bol bol

| REF | (cm) | CL | |
|------------|----------|----|--------|
| 0230463013 | 11.5x8.5 | 20 | 06/072 |

empilhável
stackable
apilable
empilable

PORCELANA
PORCELAIN
PORCELANA
PORCELAINE



FORMA P/MUFFINS

muffins mould molde para queque moule pour muffins

| REF | (cm) | CL | |
|------------|-------|------|--------|
| 0230760313 | 9.5x4 | 15.8 | 12/072 |



PORCELANA
PORCELAIN
PORCELANA
PORCELAINE



RAMEQUIM

ramekin ramequin ramequin

| REF | (cm) | CL | |
|-------------|------|-------------|-------------|
| 0230480270 | 1 | Ø6x2.5 | 5.5 06/072 |
| 0230480268 | | Ø7.5x3.5 | 10 06/144 |
| 0230480269 | | Ø9x4.5 | 15 06/072 |
| 0232744240 | | Ø9x4.5 | 17 06/072 |
| 0230760887 | 2 | Ø6.5x3.4 | 6 01/144 |
| 02307620371 | | Ø8x4.5 | 13.5 01/096 |
| 0230762037 | | Ø10x5.5 | 26 12/072 |
| 0232746024 | 3 | 9.2x9.2x5.3 | 20 04/072 |



mesa table mesa table



PORCELANA
PORCELAIN
PORCELAINA
PORCELAINE

PRATO QUADRADO C/TAÇA
plate with bowl plato con bol assiette avec bol

| REF | (cm) | CL | |
|------------|---------------------|----|--------|
| 0230760598 | 20x20 7.5x7.5x3.2 | 10 | 06/024 |



PORCELANA
PORCELAIN
PORCELAINA
PORCELAINE

TABULEIRO C/4 TAÇAS
tray with 4 bowls fuente con 4 bols plateau avec 4 bols

| REF | (cm) | CL | |
|------------|--------------------------|----|--------|
| 0230760599 | 40x14 7.5x7.5x3.2 (4x) | 40 | 01/012 |



PORCELANA
PORCELAIN
PORCELAINA
PORCELAINE

TAÇA TRIPLA
bowl bol bol

| REF | (cm) | CL | |
|------------|-------------|----|--------|
| 0233910522 | 28.5x10x5.5 | - | 00/024 |



PORCELANA
PORCELAIN
PORCELAINA
PORCELAINE

CONJUNTO 4 TAÇAS + BASE
set 4 bowls + platter
conjunto 4 bols + fuente
ensemble 4 bols + plat à servir

| REF | (cm) | CL | |
|------------|------|----|--------|
| 0230761123 | - | 8 | 01/018 |

suporte support apoio support 43.5x9x1.5
taça bol taza fassse Ø8x4.7 (4x)

NOVO
new

PORCELANA
PORCELAIN
PORCELAINA
PORCELAINE



CONJUNTO 4 TAÇAS + BASE
set 4 bowls + platter
conjunto 4 bols + fuente
ensemble 4 bols + plat à servir

| REF | (cm) | |
|------------|------|--------|
| 0234110014 | - | 01/012 |

suporte support apoio support 21.5x21.5x5.3
taça bol taza fassse 7.5x7.5x4.3 (4x)

NOVO
new

PORCELANA
PORCELAIN
PORCELANA
PORCELAINE



CONJUNTO 3 TAÇAS + BASE

set 3 bowls + platter
conjunto 3 bols + fuente
ensemble 3 bols + plat à servir

| REF | (cm) | |
|------------|------|--------|
| 0234110115 | - | 01/018 |

suporte support apoio support 25.7x8.5x1.3
taça bol taza tasse 7.5x7.5x4.3 (3x)

PORCELANA
PORCELAIN
PORCELANA
PORCELAINE



CONJUNTO 3 TAÇAS + BASE

set 3 bowls + platter
conjunto 3 bols + fuente
ensemble 3 bols + plat à servir

| REF | (cm) | CL | |
|------------|------|----|--------|
| 0230533312 | - | 9 | 01/018 |

suporte support apoio support 29x9x1.8
taça bol taza tasse 7.8x7.8x3 (3x)



PORCELANA
PORCELAIN
PORCELANA
PORCELAINE



CONJUNTO 3 TAÇAS + BASE

set 3 bowls + platter
conjunto 3 bols + fuente
ensemble 3 bols + plat à servir

| REF | (cm) | CL | |
|------------|------|----|--------|
| 0233914842 | - | - | 01/024 |

suporte support apoio support 25.5x18.8x1.5
taça bol taza tasse 8.2x8.2x4.5 (3x)



PORCELANA
PORCELAIN
PORCELANA
PORCELAINE



CONJUNTO 3 TAÇAS + BASE

set 3 bowls + platter
conjunto 3 bols + fuente
ensemble 3 bols + plat à servir

| REF | (cm) | CL | |
|------------|------|----|--------|
| 0233916991 | - | - | 00/024 |

suporte support apoio support 33x10.7x1.7
taça bol taza tasse Ø8x3.5 (3x)



PORCELANA
PORCELAIN
PORCELANA
PORCELAINE



CONJUNTO 3 TAÇAS + BASE

set 3 bowls + platter
conjunto 3 bols + fuente
ensemble 3 bols + plat à servir

| REF | (cm) | CL | |
|------------|------|----|--------|
| 0233917223 | - | - | 00/012 |

suporte support apoio support 28.5x11
taça bol taza tasse 10.5x4.3 (3x)



LOUÇA DE SERVIR

tableware vajilla de servir vaisselle à servir

mesa table mesa table

PORCELANA
PORCELAIN
PORCELANA
PORCELAINE

WENGUÉ



CONJUNTO 3 TAÇAS + BASE

set 3 bowls + platter
conjunto 3 bols + fuente
ensemble 3 bols + plat à servir

| REF | (cm) | CL | |
|--|------|--------|--|
| 0438140002 | - | 01/001 | |
| suporte support apoio support 38x18x2 taça bol taza tasse 16x9.5 (3x) | | | |

PORCELANA
PORCELAIN
PORCELANA
PORCELAINE

WENGUÉ



CONJUNTO 4 RAMEQUINS + BASE

set 4 ramekins + platter
conjunto 4 ramequins + fuente
ensemble 4 ramequins + plat à servir

| REF | (cm) | CL | |
|--|------|-------------|--|
| 0438140005 | - | 54.8 01/001 | |
| suporte support apoio support 38x14x2 taça bol taza tasse Ø9x4.5 (4x) | | | |

PORCELANA
PORCELAIN
PORCELANA
PORCELAINE

WENGUÉ



CONJUNTO 3 TAÇAS + BASE

set 3 bowls + platter
conjunto 3 bols + fuente
ensemble 3 bols + plat à servir

| REF | (cm) | CL | |
|---|------|------------|--|
| 0438140008 | - | 108 01/001 | |
| suporte support apoio support 38x14.5x2 taça bol taza tasse Ø12x5 (3x) | | | |

PORCELANA
PORCELAIN
PORCELANA
PORCELAINE



TAÇA TRIANGULAR

bolwl bol bol

| REF | (cm) | CL | |
|------------|---------|------------|--|
| 0230466781 | 14x12.5 | 9.5 06/072 | |

PORCELANA
PORCELAIN
PORCELANA
PORCELAINE



PORTA APERITIVOS

appetizers plate porta aperitivos porte apéritifs

| REF | (cm) | CL | |
|------------|---------|-------------|--|
| 0232745804 | 19x19x8 | 45.5 02/016 | |

PORCELANA
PORCELAIN
PORCELANA
PORCELAINE



TAÇA C/2 DIVISÕES

bolwl bol bol

| REF | (cm) | CL | |
|------------|--------------|-----------|--|
| 0230760975 | 19.2x9.4x6.5 | 17 06/036 | |

PORCELANA
PORCELAIN
PORCELANA
PORCELAINE



PORTA APERITIVOS C/2 DIVISÕES

appetizers plate porta aperitivos porte apéritifs

| REF | (cm) | CL | |
|------------|-------------|-----------|--|
| 0230468006 | 20.5x14.5x5 | 44 06/036 | |

PORCELANA
PORCELAIN
PORCELANA
PORCELAINE



PRATO APERITIVOS C/3 DIVISÕES

appetizers plate porta aperitivos porte apéritifs

| REF | (cm) | CL | |
|------------|---------|-----------|--|
| 0230760708 | 20x20x3 | 30 06/018 | |

PORCELANA
PORCELAIN
PORCELANA
PORCELAINE



PRATO APERITIVOS C/2 DIVISÕES

appetizers plate porta aperitivos porte apéritifs

| REF | (cm) | |
|------------|-------------|--------|
| 0230461017 | 31x21.5x3.5 | 04/016 |

PORCELANA
PORCELAIN
PORCELANA
PORCELAINE



PRATO 3 DIVISÓRIAS

plate plato assiette

| REF | (cm) | |
|------------|---------|--------|
| 0230460451 | Ø20x3.4 | 01/036 |



PORCELANA
PORCELAIN
PORCELANA
PORCELAINE

PRATO 3 DIVISÓRIAS
plate plato assiette

| REF | (cm) | |
|------------|-----------|--------|
| 0230464252 | 19x19x2.3 | 01/048 |
| 0230464251 | 29x29x3 | 01/012 |



mesa table mesa table



PORCELANA
PORCELAIN
PORCELANA
PORCELAINE

AZEITONEIRA
olive dish aceitunera bol à olive

| REF | (cm) | |
|------------|---------------|--------|
| 0233910801 | 12.3x12.3x3.2 | 00/048 |
| 0230760146 | 12.5x12.5x3.2 | 12/048 |



PORCELANA
PORCELAIN
PORCELANA
PORCELAINE

PORTA APERITIVOS C/3 DIVISÕES
appetizers plate porta aperitivos porte apéritifs

| REF | (cm) | |
|------------|----------|--------|
| 0230463807 | 15x6.3x2 | 01/144 |



PORCELANA
PORCELAIN
PORCELANA
PORCELAINE

TAÇA RECTANGULAR
bowl bol bol

| REF | (cm) | CL | |
|-------------|------------|----|--------|
| 02304607812 | 10x7.5x2.5 | 10 | 06/072 |



PORCELANA
PORCELAIN
PORCELANA
PORCELAINE

MINI CAÇAROLA
mini casserole mini cacerola mini cocotte

| REF | (cm) | CL | |
|------------|----------|----|--------|
| 0232747175 | 12.5x8x4 | 14 | 01/072 |



PORCELANA
PORCELAIN
PORCELANA
PORCELAINE

TRAVESSA
platter fuente plat à servir

| REF | (cm) | CL | |
|-------------|--------|-----|--------|
| 02304600022 | 16x9.5 | 7.4 | 12/144 |



PORCELANA
PORCELAIN
PORCELANA
PORCELAINE

TRAVESSA OVAL
platter fuente plat à servir

| REF | (cm) | |
|------------|------|--------|
| 0232746429 | 17x9 | 01/096 |



PORCELANA
PORCELAIN
PORCELANA
PORCELAINE

TABULEIRO
platter fuente plat à servir

| REF | (cm) | |
|------------|---------------|--------|
| 0232745737 | 15x7.9x2.1 | 06/096 |
| 0232745735 | 17.5x11.2x2.3 | 06/048 |





PORCELANA
PORCELAIN
PORCELANA
PORCELAINE

COLHER DE DEGUSTAÇÃO
tasting spoon cuchara degustación cuillère dégustation

| REF | (cm) | CL | |
|------------|------------|--------|--|
| 0230767284 | 11.2x6.5x7 | 06/096 | |

PORCELANA
PORCELAIN
PORCELANA
PORCELAINE

COLHER DE DEGUSTAÇÃO
tasting spoon cuchara degustación cuillère dégustation

| REF | (cm) | CL | |
|------------|---------|-----|--------|
| 0230760766 | 8x8.5 | 6.6 | 16/064 |
| 0230760761 | 10x10.5 | 17 | 12/024 |

PORCELANA
PORCELAIN
PORCELANA
PORCELAINE

COLHER DE DEGUSTAÇÃO
tasting spoon cuchara degustación cuillère dégustation

| REF | (cm) | CL | |
|------------|------------|--------|--|
| 0231421001 | 11.5x5x1.9 | 12/432 | |

PORCELANA
PORCELAIN
PORCELANA
PORCELAINE

COLHER DE DEGUSTAÇÃO LÁGRIMA
tasting spoon cuchara degustación cuillère dégustation

| REF | (cm) | CL | |
|------------|--------|----|--------|
| 0230760034 | 15x9.2 | 3 | 12/072 |

PORCELANA
PORCELAIN
PORCELANA
PORCELAINE

COLHER DE DEGUSTAÇÃO
tasting spoon cuchara degustación cuillère dégustation

| REF | (cm) | CL | |
|------------|------------|-----|--------|
| 0230760774 | 10.5x4.5x4 | 1.4 | 12/144 |

PORCELANA
PORCELAIN
PORCELANA
PORCELAINE

COLHER DE DEGUSTAÇÃO
tasting spoon cuchara degustación cuillère dégustation

| REF | (cm) | CL | |
|------------|--------|-----|--------|
| 0232744777 | 13x4 | 1 | 40/480 |
| 0220646003 | 13x4.5 | 1.3 | 48/576 |

PORCELANA
PORCELAIN
PORCELANA
PORCELAINE

COLHER DE DEGUSTAÇÃO
tasting spoon cuchara degustación cuillère dégustation

| REF | (cm) | CL | |
|------------|----------|----|--------|
| 0230532365 | 10x5x1.5 | 1 | 12/288 |

PORCELANA
PORCELAIN
PORCELANA
PORCELAINE

COLHER DE DEGUSTAÇÃO
tasting spoon cuchara degustación cuillère dégustation

| REF | (cm) | CL | |
|-------------|--------------|-----|--------|
| 02305309613 | 10x2x1 | 0.1 | 00/050 |
| 02305309612 | 12.3x2.4x1.5 | 0.3 | 12/864 |

INOX

COLHER DE DEGUSTAÇÃO
tasting spoon cuchara degustación cuillère dégustation

| REF | (cm) | CL | |
|------------|--------------|----|--------|
| 0432270013 | 13.5x4.2x3.5 | 1 | 30/300 |



CHÁVENA ALMOÇO A44
lunch cup taza almuerzo tasse déjeuner

| REF | (cm) | CL | |
|-------------|-------|----|--------|
| 02305500442 | Ø10x6 | 30 | 12/072 |



CHÁVENA CONSOMÉ A77 CUP
consomme cup taza consome tasse bouillon

| REF | (cm) | CL | |
|-------------|-------|----|--------|
| 02304600771 | Ø10x6 | 30 | 06/060 |



CHÁVENA CHÁ A07
tea cup taza tè tasse thé

| REF | (cm) | CL | |
|---|--------|----|--------|
| 0230460007 | Ø8.5x6 | 17 | 12/093 |
| PIRES A25 saucer platillo soucoupe | | | |
| 0230460025 | Ø15 | | 14/072 |



CHÁVENA MEIA DE LEITE A200
coffee/milk cup taza media de leche tasse grand macchiato

| REF | (cm) | CL | |
|---|----------|----|--------|
| 0230460200 | Ø8.5x6.5 | 20 | 01/072 |
| PIRES A25 saucer platillo soucoupe | | | |
| 0230460025 | Ø15 | | 12/072 |



CHÁVENA MEIA DE LEITE/CHÁ A54 - K
coffee/milk cup taza media de leche tasse grand macchiato

| REF | (cm) | CL | |
|---|------|----|--------|
| 0230450054 | Ø9x5 | 24 | 01/060 |
| PIRES A25 saucer platillo soucoupe | | | |
| 0230460025 | Ø15 | | 12/072 |



CHÁVENA CAFÉ EXPRESSO A13
coffee cup taza café tasse café

| REF | (cm) | CL | |
|---------------------------------------|-----------|----|--------|
| 02304600131 | Ø6.5x4.5 | 5 | 12/144 |
| PIRES saucer platillo soucoupe | | | |
| 0230460010 | Ø12 A10 | | 24/144 |
| 0231420014 | Ø12.4 A14 | | 12/144 |



CHÁVENA CAFÉ EXPRESSO H05
coffee cup taza café tasse café

| REF | (cm) | CL | |
|---------------------------------------|-----------|----|--------|
| 0230450005 | Ø6.4x6 | 9 | 06/072 |
| PIRES saucer platillo soucoupe | | | |
| 0230460010 | Ø12 A10 | | 24/144 |
| 0231420014 | Ø12.4 A14 | | 12/144 |



CHÁVENA CAFÉ EXPRESSO
coffee cup taza café tasse café

| REF | (cm) | CL | |
|---------------------------------------|-----------|----|--------|
| 02304600011 | Ø6x6 | 8 | 12/144 |
| PIRES saucer platillo soucoupe | | | |
| 0230460010 | Ø12 A10 | | 24/144 |
| 0231420014 | Ø12.4 A14 | | 12/144 |



CHÁVENA CHÁ A25 GA
tea cup taza tè tasse thé

| REF | (cm) | CL | |
|---|------|----|--------|
| 02304500251 | Ø7x8 | 20 | 12/144 |
| PIRES A25 saucer platillo soucoupe | | | |
| 0230460025 | Ø15 | | 12/072 |





PORCELANA
PORCELAIN
PORCELANA
PORCELAINE



CHÁVENA CAFÉ EXPRESSO A03-2
coffee cup taza café tasse café

| REF | (cm) | CL | |
|---------------------------------------|-----------|----|--------|
| 02304500034 | Ø5x6 | 5 | 06/144 |
| PIRES saucer platillo soucoupe | | | |
| 0230460010 | Ø12 A10 | | 24/144 |
| 0231420014 | Ø12.4 A14 | | 12/144 |



PORCELANA
PORCELAIN
PORCELANA
PORCELAINE



CHÁVENA CAFÉ EXPRESSO A03-1
coffee cup taza café tasse café

| REF | (cm) | CL | |
|---------------------------------------|-----------|----|--------|
| 02304500035 | Ø5.5x6 | 5 | 12/144 |
| PIRES saucer platillo soucoupe | | | |
| 0230460010 | Ø12 A10 | | 24/144 |
| 0231420014 | Ø12.4 A14 | | 12/144 |



PORCELANA
PORCELAIN
PORCELANA
PORCELAINE



CHÁVENA MEIA DE LEITE H06
coffee / milk cup taza media de leche tasse grand macchiato

| REF | (cm) | CL | |
|---------------------------------------|-----------|----|--------|
| 02304500061 | Ø7.5x7.5 | 20 | 12/072 |
| PIRES saucer platillo soucoupe | | | |
| 0231420025 | Ø14 A25-1 | | 12/072 |
| 0230460025 | Ø15 A25 | | 12/072 |



PORCELANA
PORCELAIN
PORCELANA
PORCELAINE



CHÁVENA CAFÉ EXPRESSO A29
coffee cup taza café tasse café

| REF | (cm) | CL | |
|---------------------------------------|-----------|-----|--------|
| 0232120029 | Ø5.5x6 | 6.5 | 24/144 |
| PIRES saucer platillo soucoupe | | | |
| 0230460010 | Ø12 A10 | | 24/144 |
| 0231420014 | Ø12.4 A14 | | 12/144 |



PORCELANA
PORCELAIN
PORCELANA
PORCELAINE



CHÁVENA ALMOÇO CÔNICA A22-2
lunch cup taza almuerzo tasse déjeuner

| REF | (cm) | CL | |
|---|--------|----|--------|
| 02321200222 | Ø8.5x9 | 22 | 12/060 |
| PIRES A25 saucer platillo soucoupe | | | |
| 0230460025 | Ø15 | | 12/072 |

PORCELANA
PORCELAIN
PORCELANA
PORCELAINE



CHÁVENA CHÁ CÔNICA A21-2
tea cup taza té tasse thé

| REF | (cm) | CL | |
|---|--------|----|--------|
| 02321200212 | Ø7.5x8 | 16 | 12/072 |
| PIRES A25-1 saucer platillo soucoupe | | | |
| 0231420025 | Ø14 | | 12/072 |



PORCELANA
PORCELAIN
PORCELANA
PORCELAINE

CHÁVENA CAFÉ EXPRESSO CÔNICA A20-2
coffee cup taza café tasse café

| REF | (cm) | CL | |
|---|------|----|--------|
| 02321200202 | Ø6x7 | 8 | 24/144 |
| PIRES A25 saucer platillo soucoupe | | | |
| 0230460025 | Ø15 | | 12/072 |

PORCELANA
PORCELAIN
PORCELANA
PORCELAINE



CHÁVENA CAFÉ EXPRESSO CÔNICA A19-2
coffee cup taza café tasse café

| REF | (cm) | CL | |
|---------------------------------------|-----------|----|--------|
| 02321200192 | Ø5.5x6.5 | 6 | 24/144 |
| PIRES saucer platillo soucoupe | | | |
| 0230460010 | Ø12 A10 | | 24/144 |
| 0231420014 | Ø12.4 A14 | | 12/144 |

PORCELANA
PORCELAIN
PORCELANA
PORCELAINE



CHÁVENA CHÁ CÔNICA A24-4
tea cup taza té tasse thé

| REF | (cm) | CL | |
|---|--------|----|--------|
| 0230450244 | Ø8.5x9 | 20 | 12/072 |
| PIRES A25 saucer platillo soucoupe | | | |
| 0230460025 | Ø15 | | 12/072 |



PORCELANA
PORCELAIN
PORCELANA
PORCELAINE

CHÁVENA CHÁ CÓNICA A24-1
tea cup taza té tasse thé

| REF | (cm) | CL | |
|------------|----------|----|--------|
| 0231420024 | Ø8.2x8.2 | 16 | 01/096 |

PIRES A25 saucer platillo soucoupe

| | | | |
|------------|-----|--|--------|
| 0230460025 | Ø15 | | 12/072 |
|------------|-----|--|--------|



PORCELANA
PORCELAIN
PORCELANA
PORCELAINE

CHÁVENA CAFÉ EXPRESSO CÓNICA A24-3
coffee cup taza café tasse café

| REF | (cm) | CL | |
|-------------|--------|----|--------|
| 02321200243 | Ø6.5x7 | 8 | 12/144 |

PIRES saucer platillo soucoupe

| | | | |
|------------|-----------|--|--------|
| 0230460010 | Ø12 A10 | | 24/144 |
| 0231420014 | Ø12.4 A14 | | 12/144 |



PORCELANA
PORCELAIN
PORCELANA
PORCELAINE

CHÁVENA CAFÉ EXPRESSO CÓNICA A24
coffee cup taza café tasse café

| REF | (cm) | CL | |
|-------------|--------|----|--------|
| 02314200242 | Ø6x6.5 | 6 | 12/144 |

PIRES saucer platillo soucoupe

| | | | |
|------------|-----------|--|--------|
| 0230460010 | Ø12 A10 | | 24/144 |
| 0231420014 | Ø12.4 A14 | | 12/144 |



PORCELANA
PORCELAIN
PORCELANA
PORCELAINE

CHÁVENA CAFÉ EXPRESSO CÓNICA A19
coffee cup taza café tasse café

| REF | (cm) | CL | |
|-------------|----------|----|--------|
| 02304600191 | Ø5.5x6.5 | 7 | 12/144 |

PIRES saucer platillo soucoupe

| | | | |
|------------|-----------|--|--------|
| 0230460010 | Ø12 A10 | | 24/144 |
| 0231420014 | Ø12.4 A14 | | 12/144 |



PORCELANA
PORCELAIN
PORCELANA
PORCELAINE

CHÁVENA CHÁ CÓNICA A27-2
tea cup taza té tasse thé

| REF | (cm) | CL | |
|-------------|--------|----|--------|
| 02321200272 | Ø8x8.5 | 15 | 12/060 |

PIRES saucer platillo soucoupe

| | | | |
|------------|-----------|--|--------|
| 0231420025 | Ø14 A25-1 | | 12/072 |
| 0230460025 | Ø15 A25 | | 12/072 |



PORCELANA
PORCELAIN
PORCELANA
PORCELAINE

CHÁVENA CAFÉ EXPRESSO CÓNICA A24-2
coffee cup taza café tasse café

| REF | (cm) | CL | |
|-------------|--------|----|--------|
| 02321200242 | Ø8x8.5 | 5 | 12/144 |

PIRES saucer platillo soucoupe

| | | | |
|------------|-----------|--|--------|
| 0230460010 | Ø12 A10 | | 24/144 |
| 0231420014 | Ø12.4 A14 | | 12/144 |



PORCELANA
PORCELAIN
PORCELANA
PORCELAINE

CHÁVENA ALMOÇO CÓNICA A02
lunch cup taza almuerzo tasse déjeuner

| REF | (cm) | CL | |
|-------------|--------|----|--------|
| 02321200022 | Ø8x8.5 | 23 | 12/048 |

PIRES saucer platillo soucoupe

| | | | |
|------------|-----|--|--------|
| 0230460025 | Ø15 | | 12/072 |
|------------|-----|--|--------|



PORCELANA
PORCELAIN
PORCELANA
PORCELAINE

CHÁVENA MEIA DE LEITE A02/35
coffee/milk cup taza media de leche tasse grand macchiato

| REF | (cm) | CL | |
|------------|--------|----|--------|
| 0232120002 | Ø8x8.5 | 20 | 12/096 |

PIRES A25-1 saucer platillo soucoupe

| | | | |
|------------|-----|--|--------|
| 0231420025 | Ø14 | | 12/072 |
|------------|-----|--|--------|



LOUÇA DE SERVIR

tableware vajilla de servir vaisselle à servir



PORCELANA
PORCELAIN
PORCELANA
PORCELAINE

CHÁVENA CHÁ A05
tea cup taza tè tasse thé

| REF | (cm) | CL | |
|------------|----------|----|--------|
| 0232120005 | Ø7.5x7.5 | 15 | 12/096 |

PIRES A25 saucer platillo soucoupe

| | | | |
|------------|-----|--|--------|
| 0230460025 | Ø15 | | 12/072 |
|------------|-----|--|--------|



PORCELANA
PORCELAIN
PORCELANA
PORCELAINE

CHÁVENA CAFÉ EXPRESSO CORTADO A06-1
coffee cup taza café tasse café

| REF | (cm) | CL | |
|-------------|----------|----|--------|
| 02321420061 | Ø6.5x6.5 | 9 | 12/144 |

PIRES saucer platillo soucoupe

| | | | |
|------------|-----------|--|--------|
| 0230460010 | Ø12 A10 | | 24/144 |
| 0231420014 | Ø12.4 A14 | | 12/144 |



PORCELANA
PORCELAIN
PORCELANA
PORCELAINE

CHÁVENA CAFÉ EXPRESSO CORTADO A06
coffee cup taza café tasse café

| REF | (cm) | CL | |
|------------|------|-----|--------|
| 0232120006 | Ø7x7 | 9.5 | 12/096 |

PIRES saucer platillo soucoupe

| | | | |
|------------|-----------|--|--------|
| 0230460010 | Ø12 A10 | | 24/144 |
| 0231420014 | Ø12.4 A14 | | 12/144 |



PORCELANA
PORCELAIN
PORCELANA
PORCELAINE

CHÁVENA CAFÉ EXPRESSO A04
coffee cup taza café tasse café

| REF | (cm) | CL | |
|-------------|------|----|--------|
| 02304500041 | Ø6x6 | 5 | 24/144 |

PIRES saucer platillo soucoupe

| | | | |
|------------|-----------|--|--------|
| 0230460010 | Ø12 A10 | | 24/144 |
| 0231420014 | Ø12.4 A14 | | 12/144 |



PORCELANA
PORCELAIN
PORCELANA
PORCELAINE

CHÁVENA CAFÉ EXPRESSO 8014
coffee cup taza café tasse café

| REF | (cm) | CL | |
|------------|----------|----|--------|
| 0230468014 | Ø5.5x6.5 | 6 | 12/144 |

PIRES saucer platillo soucoupe

| | | | |
|------------|-----------|--|--------|
| 0230460010 | Ø12 A10 | | 24/144 |
| 0231420014 | Ø12.4 A14 | | 12/144 |



PORCELANA
PORCELAIN
PORCELANA
PORCELAINE

CHÁVENA CAFÉ EXPRESSO 8014
coffee cup taza café tasse café

| REF | (cm) | CL | |
|------------|----------|----|--------|
| 0230450052 | Ø6.8x6.8 | 10 | 12/096 |

PIRES saucer platillo soucoupe

| | | | |
|------------|-----------|--|--------|
| 0230460010 | Ø12 A10 | | 24/144 |
| 0231420014 | Ø12.4 A14 | | 12/144 |



PORCELANA
PORCELAIN
PORCELANA
PORCELAINE

CHÁVENA ALMOÇO JUMBO MADRID A30-4
lunch cup taza almuerzo tasse déjeuner

| REF | (cm) | CL | |
|-------------|---------|----|--------|
| 02321200304 | Ø10x8.7 | 30 | 12/048 |

PIRES A25 saucer platillo soucoupe

| | | | |
|------------|-----|--|--------|
| 0230460025 | Ø15 | | 12/072 |
|------------|-----|--|--------|



PORCELANA
PORCELAIN
PORCELANA
PORCELAINE

CHÁVENA ALMOÇO MADRID A30-3
lunch cup taza almuerzo tasse déjeuner

| REF | (cm) | CL | |
|-------------|--------|------|--------|
| 02321200303 | Ø9.7x7 | 26.5 | 12/060 |

PIRES A25-1 saucer platillo soucoupe

| | | | |
|------------|-----|--|--------|
| 0231420025 | Ø14 | | 12/072 |
|------------|-----|--|--------|



**NOVO
new**

PORCELANA
PORCELAIN
PORCELANA
PORCELAINE

CHÁVENA CHÁ/MEIA DE LEITE MADRID A30-5
lunch cup taza almuerzo tasse déjeuner

| REF | (cm) | CL | |
|------------|----------|----|--------|
| 0230450305 | Ø7.7x8.5 | 24 | 12/072 |

PIRES A25-1 saucer platillo soucoupe

| | | | |
|------------|-----|--|--------|
| 0231420025 | Ø14 | | 12/072 |
|------------|-----|--|--------|



PORCELANA
PORCELAIN
PORCELANA
PORCELAINE

CHÁVENA MEIA DE LEITE/CHÁ MADRID A30-2
coffee / milk / tea cup
taza media de leche / thé
tasse grand macchiato / thé

| REF | (cm) | CL | |
|-------------|----------|----|--------|
| 02321200302 | Ø8.5x6.5 | 19 | 12/096 |

PIRES A25 saucer platillo soucoupe

| | | | |
|------------|-----|--|--------|
| 0230460025 | Ø15 | | 12/072 |
|------------|-----|--|--------|



PORCELANA
PORCELAIN
PORCELANA
PORCELAINE

CHÁVENA CAFÉ EXPRESSO MADRID A30-1
coffee cup taza café tasse café

| REF | (cm) | CL | |
|-------------|--------|----|--------|
| 02321200301 | Ø6.5x6 | 9 | 24/144 |

PIRES saucer platillo soucoupe

| | | | |
|------------|-----------|--|--------|
| 0230460010 | Ø12 A10 | | 24/144 |
| 0231420014 | Ø12.4 A14 | | 12/144 |



PORCELANA
PORCELAIN
PORCELANA
PORCELAINE

CHÁVENA CAFÉ EXPRESSO MADRID A30
coffee cup taza café tasse café

| REF | (cm) | CL | |
|------------|----------|----|--------|
| 0232120030 | Ø5.5x6.5 | 6 | 24/144 |

PIRES saucer platillo soucoupe

| | | | |
|------------|-----------|--|--------|
| 0230460010 | Ø12 A10 | | 24/144 |
| 0231420014 | Ø12.4 A14 | | 12/144 |



PORCELANA
PORCELAIN
PORCELANA
PORCELAINE

CHÁVENA CAFÉ EXPRESSO MADRID A30-A
coffee cup taza café tasse café

| REF | (cm) | CL | |
|---------------------------------------|-----------|----|--------|
| 02321200305 | Ø5.5x6.5 | 6 | 24/144 |
| PIRES saucer platillo soucoupe | | | |
| 0230460010 | Ø12 A10 | | 24/144 |
| 0231420014 | Ø12.4 A14 | | 12/144 |



PORCELANA
PORCELAIN
PORCELANA
PORCELAINE

CHÁVENA CAFÉ EXPRESSO ALTA 8028
coffee cup taza café tasse café

| REF | (cm) | CL | |
|---------------------------------------|-----------|----|--------|
| 02304680282 | Ø5x6.8 | 6 | 24/144 |
| PIRES saucer platillo soucoupe | | | |
| 0230460010 | Ø12 A10 | | 24/144 |
| 0231420014 | Ø12.4 A14 | | 12/144 |



PORCELANA
PORCELAIN
PORCELANA
PORCELAINE

CHÁVENA CAFÉ EXPRESSO A18
coffee cup taza café tasse café

| REF | (cm) | CL | |
|---------------------------------------|-----------|----|--------|
| 02304500181 | Ø5.5x7.5 | 7 | 12/216 |
| PIRES saucer platillo soucoupe | | | |
| 0230460010 | Ø12 A10 | | 24/144 |
| 0231420014 | Ø12.4 A14 | | 12/144 |



PORCELANA
PORCELAIN
PORCELANA
PORCELAINE

CHÁVENA CAFÉ EXPRESSO A26
coffee cup taza café tasse café

| REF | (cm) | CL | |
|---------------------------------------|-----------|-----|--------|
| 0231420026 | Ø5.5x7.5 | 6.5 | 12/216 |
| PIRES saucer platillo soucoupe | | | |
| 0230460010 | Ø12 A10 | | 24/144 |
| 0231420014 | Ø12.4 A14 | | 12/144 |



PORCELANA
PORCELAIN
PORCELANA
PORCELAINE

CHÁVENA CAFÉ EXPRESSO A09
coffee cup taza café tasse café

| REF | (cm) | CL | |
|---------------------------------------|-----------|----|--------|
| 0231420009 | Ø5.5x7.5 | 5 | 12/216 |
| PIRES saucer platillo soucoupe | | | |
| 0230460010 | Ø12 A10 | | 24/144 |
| 0231420014 | Ø12.4 A14 | | 12/144 |



empilhável
stackable
apilable
empilable

PORCELANA
PORCELAIN
PORCELANA
PORCELAINE

CHÁVENA CAFÉ C/FILADO PRATEADO A08-1
coffee cup taza café tasse café

| REF | (cm) | CL | |
|---------------------------------------|-----------|----|--------|
| 02302100082 | Ø5.5x6 | 5 | 12/216 |
| PIRES saucer platillo soucoupe | | | |
| 0230460010 | Ø12 A10 | | 24/144 |
| 0231420014 | Ø12.4 A14 | | 12/144 |



PORCELANA
PORCELAIN
PORCELANA
PORCELAINE

CHÁVENA/PIRES CAFÉ MODELO 6
coffee cup / saucer taza / platillo café tasse / soucoupe café

| REF | (cm) | CL | |
|---|--------|----|--------|
| 02304600061 | Ø5x6.5 | 7 | 06/072 |
| Pires saucer platillo soucoupe Ø12 | | | |



PORCELANA
PORCELAIN
PORCELANA
PORCELAINE

CHÁVENA/PIRES CHÁ A11-1
tea cup / saucer taza / platillo té tasse / soucoupe thé

| REF | (cm) | CL | |
|---|--------|----|--------|
| 02304500111 | Ø7x8.5 | 11 | 06/048 |
| Pires saucer platillo soucoupe Ø14.5 | | | |



NOVO
new
PORCELANA
PORCELAIN
PORCELANA
PORCELAINE

CHÁVENA CAFÉ EXPRESSO
coffee cup taza café tasse café

| REF | (cm) | CL | |
|------------|--------|-----|--------|
| 0234108029 | Ø5x6.3 | 5.9 | 08/144 |



mesa table mesa table



elegância na mesa

elegance on the table
elegancia en la mesa
élégancesur la table



PORCELANA
PORCELAIN
PORCELANA
PORCELAINE

CHÁVENA ALMOÇO ONDAS
lunch cup taza almuerzo tasse déjeuner

| REF | (cm) | CL | |
|------------|-----------|----|--------|
| 0230468719 | Ø11.5x6.5 | 35 | 06/072 |



PORCELANA
PORCELAIN
PORCELANA
PORCELAINE

CHÁVENA CONSOMÉ ONDAS
consomme cup taza consome tasse bouillon

| REF | (cm) | CL | |
|-------------|-----------|----|--------|
| 02304687191 | Ø11.5x6.5 | 32 | 06/072 |



PORCELANA
PORCELAIN
PORCELANA
PORCELAINE

PIRES ONDAS
saucer platillo soucoupe

| REF | (cm) | |
|-------------|------|--------|
| 02304687192 | Ø17 | 06/072 |



PORCELANA
PORCELAIN
PORCELANA
PORCELAINE

PIRES ALMOÇO/CONSOMÉ A44-1
saucer platillo soucoupe

| REF | (cm) | |
|-------------|----------------------|--------|
| 0231420441 | Ø15.5 A44-1 | 12/072 |
| 02304500441 | Ø16.8 A44 | 06/060 |



PORCELANA
PORCELAIN
PORCELANA
PORCELAINE

PIRES CHÁ
saucer platillo soucoupe

| REF | (cm) | |
|------------|--------------------|--------|
| 0230460025 | Ø15 A25 | 12/072 |
| 0231420025 | Ø15 A25.1 | 12/072 |



PORCELANA
PORCELAIN
PORCELANA
PORCELAINE

PIRES CHÁ A25-2
saucer platillo soucoupe

| REF | (cm) | |
|-------------|-------|--------|
| 02304600253 | Ø13.5 | 12/072 |



PORCELANA
PORCELAIN
PORCELANA
PORCELAINE

PIRES CAFÉ A14
saucer platillo soucoupe

| REF | (cm) | |
|------------|-------|--------|
| 0231420014 | Ø12.4 | 12/144 |



PORCELANA
PORCELAIN
PORCELANA
PORCELAINE

PIRES CAFÉ A10
saucer platillo soucoupe

| REF | (cm) | |
|------------|------|--------|
| 0230460010 | Ø12 | 24/144 |



PORCELANA FINA
fine porcelain porcelana fina porcelaine fine



PORCELANA
PORCELAIN
PORCELANA
PORCELAINE

CHÁVENA ALMOÇO JUMBO A65
lunch cup / taza almuerzo / tasse déjeuner

| REF | (cm) | CL | |
|------------|-------|----|--------|
| 0230450065 | Ø10x8 | 50 | 12/036 |

PIRES saucer platillo soucoupe

| | | | |
|-------------|-------|--|--------|
| 02200106121 | Ø16.3 | | 12/144 |
|-------------|-------|--|--------|



PORCELANA
PORCELAIN
PORCELANA
PORCELAINE

CHÁVENA/PIRES ALMOÇO A134
lunch cup / saucer
taza / platillo almuerzo
tasse / soucoupe thé

| REF | (cm) | CL | |
|------------|--------|----|--------|
| 0230760134 | Ø9x6.5 | 25 | 06/024 |

Pires saucer platillo soucoupe 015



PORCELANA
PORCELAIN
PORCELANA
PORCELAINE

CHÁVENA MEIA DE LEITE A131C
coffee / milk cup / taza media de leche / tasse grand macchiato

| REF | (cm) | CL | |
|------------|--------|----|--------|
| 0230760131 | Ø8.5x6 | 18 | 06/024 |

PIRES A25 saucer platillo soucoupe

| | | | |
|------------|-----|--|--------|
| 0230460025 | Ø15 | | 12/072 |
|------------|-----|--|--------|



PORCELANA
PORCELAIN
PORCELANA
PORCELAINE

CHÁVENA/PIRES CHÁ
tea cup / saucer / taza / platillo té / tasse / soucoupe thé

| REF | (cm) | CL | |
|------------|----------|----|--------|
| 0230760006 | Ø7.5x5.5 | 12 | 06/048 |

Pires saucer platillo soucoupe 013.5



PORCELANA
PORCELAIN
PORCELANA
PORCELAINE

CHÁVENA/PIRES CAFÉ A216
coffee cup / saucer / taza / platillo café / tasse / soucoupe café

| REF | (cm) | CL | |
|------------|----------|----|--------|
| 0230760216 | Ø6.5x5.5 | 68 | 06/048 |

Pires saucer platillo soucoupe 012



PORCELANA
PORCELAIN
PORCELANA
PORCELAINE

CHÁVENA ALMOÇO SINO A35
lunch cup / taza almuerzo / tasse déjeuner

| REF | (cm) | CL | |
|-------------|---------|----|--------|
| 02105500351 | Ø11x7.5 | 18 | 06/060 |

PIRES A35 saucer platillo soucoupe

| | | | |
|-------------|-----|--|--------|
| 02105500352 | Ø16 | | 10/060 |
|-------------|-----|--|--------|



PORCELANA
PORCELAIN
PORCELANA
PORCELAINE

empilhável
stackable
apilable
empilable

CANECA DE HOTEL EMPILHÁVEL
stacable mug jarra apilable tasse empilable

| REF | (cm) | CL | |
|------------|--------|----|--------|
| 0230465039 | Ø8x9.5 | 28 | 00/048 |



PORCELANA
PORCELAIN
PORCELANA
PORCELAINE

CHÁVENA C/TAMPA/PIRES CHÁ
teacup/saucer taza/platillo tè tasse/soucoupe thé

| REF | (cm) | CL | |
|------------|-------------------|----|--------|
| 0230464599 | Ø8.5x8.5 Ø8x1.9 | 30 | 00/048 |

PORCELANA
PORCELAIN
PORCELANA
PORCELAINE



BULE + CHÁVENA/PIRES
teapot+cup/saucer
tetera+taza/platillo
théière+tasse/soucoupe

| REF | (cm) | CL | |
|-------------|------|----|--------|
| 02304600014 | - | - | 01/036 |

bule teapot tetera théière Ø10.5x10.5 |34cl
chávena cup taza tasse Ø10x5.5 |20cl
pires saucer platillo soucoupe Ø14.5

PORCELANA
PORCELAIN
PORCELANA
PORCELAINE



BULE + CHÁVENA/PIRES
teapot+cup/saucer
tetera+taza/platillo
théière+tasse/soucoupe

| REF | (cm) | CL | |
|------------|------|----|--------|
| 0230760228 | - | 34 | 01/012 |

bule teapot tetera théière Ø10x9.5 |34cl
chávena cup taza tasse Ø10 |24cl
pires saucer platillo soucoupe Ø16

PORCELANA
PORCELAIN
PORCELANA
PORCELAINE



BULE
tea pot tetera théière

| REF | (cm) | LT | |
|-------------|------|------|--------|
| 0210760629 | Ø13 | 1 | 01/012 |
| 02107606291 | Ø12 | 0.51 | 01/024 |

PORCELANA
PORCELAIN
PORCELANA
PORCELAINE



BULE
teapot tetera théière

| REF | (cm) | LT | |
|------------|------------|-----|--------|
| 0230768411 | 23x15.5x14 | 1.1 | 01/012 |

PORCELANA
PORCELAIN
PORCELANA
PORCELAINE



BULE
teapot tetera théière

| REF | (cm) | LT | |
|------------|--------------|-----|--------|
| 0230761446 | 18.5x11.5x13 | 0.6 | 01/018 |

PORCELANA
PORCELAIN
PORCELANA
PORCELAINE



BULE
tea pot tetera théière

| REF | (cm) | LT | |
|-------------|----------|-----|--------|
| 02307601801 | Ø14x14.5 | 1 | 01/012 |
| 0230760180 | Ø12x12.5 | 0.5 | 01/024 |

PORCELANA
PORCELAIN
PORCELANA
PORCELAINE



BULE
tea pot tetera théière

| REF | (cm) | LT | |
|------------|----------|----|--------|
| 0233917461 | Ø13.5x13 | 1 | 01/012 |





PORCELANA
PORCELAIN
PORCELANA
PORCELAINE

BULE
tea pot tetera théière

| REF | (cm) | LT | |
|-------------|------------|------|--------|
| 0230760927 | Ø10.5x10.5 | 0.5 | 01/024 |
| 02307609271 | Ø9.5x9.5 | 0.36 | 00/036 |



PORCELANA
PORCELAIN
PORCELANA
PORCELAINE

BULE
tea pot tetera théière

| REF | (cm) | LT | |
|-------------|------------|-----|--------|
| 02304615821 | Ø12x12 | 0.7 | 01/036 |
| 0230461582 | Ø10.5x10.5 | 0.4 | 01/036 |



PORCELANA
PORCELAIN
PORCELANA
PORCELAINE

BULE
tea pot tetera théière

com filtro no bico
with filter in beak
con filtro en pico
avec filtre dans le bec

| REF | (cm) | LT | |
|------------|----------|------|--------|
| 0233740001 | Ø13.5x12 | 0.75 | 01/012 |



PORCELANA
PORCELAIN
PORCELANA
PORCELAINE

BULE
tea pot tetera théière

| REF | (cm) | LT | |
|------------|----------|-----|--------|
| 0230760011 | Ø11x12.5 | 0.6 | 00/024 |



PORCELANA
PORCELAIN
PORCELANA
PORCELAINE

BULE C/FILTRO
tea pot with filter tetera con filtro théière avec filtre

| REF | (cm) | LT | |
|------------|------------|-----|--------|
| 0230760013 | Ø13.5x10.5 | 0.6 | 00/024 |



FERRO IRON HIERRO FER

BULE C/FILTRO
tea pot with filter tetera con filtro théière avec filtre

| REF | (cm) | LT | |
|------------|----------|-----|--------|
| 0432270047 | Ø14x11.5 | 0.8 | 01/008 |

INTERIOR ESMALTADO ENAMELED INTERIOR
INTERIOR ESMALTADO INTERIEUR ÉMAILLÉ



+ BULES
tea pots
teteras
théières
pg. 276/277



PORCELANA
PORCELAIN
PORCELANA
PORCELAINE

LEITEIRA/CREMEIRA
milk jug lechera crémier

| REF | (cm) | CL | |
|------------|---------|----|--------|
| 0230761516 | 9.6x7x7 | 12 | 06/072 |



PORCELANA
PORCELAIN
PORCELANA
PORCELAINE

LEITEIRA
milk jug lechera crémier

| REF | (cm) | CL | | |
|------------|------|--------|----|--------|
| 0230764054 | 1 | Ø6x8.5 | 32 | 06/036 |
| 0230480238 | 2 | Ø10x13 | 45 | 06/048 |



PORCELANA
PORCELAIN
PORCELANA
PORCELAINE

LEITEIRA
milk jug lechera crémier

| REF | (cm) | CL | |
|------------|--------|----|--------|
| 0230463598 | Ø6x6.7 | 10 | 01/216 |



PORCELANA
PORCELAIN
PORCELANA
PORCELAINE

LEITEIRA
milk jug lechera crémier

| REF | (cm) | CL | |
|-------------|-----------|----|--------|
| 02339174611 | Ø7.5x10.5 | 26 | 00/048 |



LOUÇA DE SERVIR

tableware vajilla de servir vaisselle à servir



PORCELANA
PORCELAIN
PORCELANA
PORCELAINE

LEITEIRA

milk jug lechera crémier

| REF | (cm) | CL | |
|------------|----------|------|--------|
| 0230461612 | Ø7.5x7.5 | 18.5 | 00/096 |



PORCELANA
PORCELAIN
PORCELANA
PORCELAINE

PLACA P/SACO CHÁ

tea bag plate plato bolsita de té soucoupe sachet de thé

| REF | (cm) | |
|------------|---------|--------|
| 0220461120 | Ø11x8.5 | 12/144 |
| 0220010272 | Ø10x8.5 | 12/192 |



PORCELANA
PORCELAIN
PORCELANA
PORCELAINE

AÇUCAREIRO

sugar bowl azucarero sucrier

| REF | (cm) | |
|------------|-----------|--------|
| 0210760131 | Ø9.5x11.2 | 01/024 |



PORCELANA
PORCELAIN
PORCELANA
PORCELAINE

AÇUCAREIRO PACOTES

sugar box azucarero paquets sucrier sachets de sucre

| REF | (cm) | |
|------------|-----------|--------|
| 0210760572 | 8.7x7.1x8 | 06/072 |



PORCELANA
PORCELAIN
PORCELANA
PORCELAINE

CANECA MASAGRIN

mazagrín mug jarra masagrín tasse mazagrín

| REF | (cm) | CL | |
|------------|-------|----|--------|
| 0220486122 | Ø8x11 | 20 | 06/036 |



PORCELANA
PORCELAIN
PORCELANA
PORCELAINE

CANECA

mug jarra tasse

| REF | (cm) | CL | |
|------------|--------------------|----|--------|
| 0220450062 | Ø8x10 A62 | 34 | 12/048 |
| 0220450071 | Ø6x7 A71 | 13 | 12/144 |



PORCELANA
PORCELAIN
PORCELANA
PORCELAINE

CANECA VINHO VERDE

mug jarra tasse

| REF | (cm) | CL | |
|------------|----------|----|--------|
| 0231420002 | Ø10x10.2 | 45 | 01/036 |



PORCELANA
PORCELAIN
PORCELANA
PORCELAINE

CANECA CERVEJA

beer mug jarra cerveza tasse bière

| REF | (cm) | CL | |
|------------|---------------------|----|--------|
| 0220485011 | Ø8x13 KD50 | 55 | 06/036 |



PORCELANA
PORCELAIN
PORCELANA
PORCELAINE

CANECA CERVEJA

beer mug jarra cerveza tasse bière

| REF | (cm) | CL | |
|------------|----------------------|----|--------|
| 0220484037 | Ø8x18 F05 | 75 | 06/024 |
| 0220484048 | Ø6.5x14 F05 | 33 | 06/036 |



PORCELANA
PORCELAIN
PORCELANA
PORCELAINE

JARRO

jug jarro pichet

| REF | (cm) | LT | |
|-------------|---------|-----|--------|
| 02307604071 | Ø10x18 | 1 | 01/012 |
| 0230760407 | Ø8x13.5 | 0.5 | 01/024 |



+ JARROS
jugs
jarros
pichets

pg. 174-176



+ JARROS
jugs
jarros
pichets

pg. 222-223



+ JARROS
jugs
jarros
pichets

pg. 271





Paşabahçe



VIDRO
GLASS
VIDRIO
VERRE

CANECA COLOMBIAN
mug jarra tasse

| REF | (cm) | CL | |
|------------|-----------|----|--------|
| 0331595861 | Ø7.5x14.5 | 26 | 02/012 |

Paşabahçe



VIDRO
GLASS
VIDRIO
VERRE

CANECA GALÃO
mug jarra tasse

| REF | (cm) | CL | |
|------------|-----------|------|--------|
| 0331595141 | Ø7.5x14.5 | 22.5 | 00/012 |

CRISAL

**NOVO
new**



VIDRO
GLASS
VIDRIO
VERRE

CANECA BILL
mug jarra tasse

| REF | (cm) | CL | |
|------------|-----------|----|--------|
| 0331012264 | Ø7.5x14.5 | 24 | 00/012 |

Paşabahçe



VIDRO
GLASS
VIDRIO
VERRE

CANECA IRISH COFFEE
mug jarra tasse

| REF | (cm) | CL | |
|------------|-----------|----|--------|
| 0331594159 | Ø7.5x14.5 | 27 | 02/012 |

Arcoroc
Serving solutions



VIDRO
GLASS
VIDRIO
VERRE

CANECA
mug jarra tasse

| REF | (cm) | CL | |
|------------|-----------|------|--------|
| 0333470029 | Ø7.5x15.5 | 33.7 | 06/036 |



VIDRO
GLASS
VIDRIO
VERRE

CANECA ARC TEA
mug jarra tasse

| REF | (cm) | CL | |
|------------|-----------|----|--------|
| 0331511123 | Ø7.5x10.5 | 23 | 06/024 |

**PACK
6**



VIDRO
GLASS
VIDRIO
VERRE

CANECA P/CHÁ
mug jarra tasse

| REF | (cm) | CL | |
|------------|------|------|--------|
| 0333472105 | Ø7x9 | 16.4 | 01/012 |

Paşabahçe



VIDRO
GLASS
VIDRIO
VERRE

CANECA
mug jarra tasse

| REF | (cm) | CL | |
|------------|---------|----|--------|
| 0331595531 | Ø8.5x10 | 34 | 12/024 |



VIDRO
GLASS
VIDRIO
VERRE

CANECA
mug jarra tasse

| REF | (cm) | CL | |
|------------|-------|----|--------|
| 0333471006 | Ø8x12 | 37 | 06/036 |



VIDRO
GLASS
VIDRIO
VERRE

CHÁVENA
mug jarra tasse

| REF | (cm) | CL | |
|------------|----------|------|--------|
| 0333472310 | 1 09x10 | 36.6 | 06/036 |
| 0333476791 | 2 Ø10x10 | 46.9 | 06/048 |



mesa table mesa table

PACK 6

VIDRO GLASS
VIDRIO
VERRE



CHÁVENA GALÃO CASABLANCA
mug jarra tasse

| REF | (cm) | CL | |
|------------|--------------|----|--------|
| 0331595202 | Ø11.45x10.55 | 27 | 06/048 |



VIDRO GLASS
VIDRIO
VERRE



CANECA VOLUTO
mug jarra tasse

| REF | (cm) | CL | |
|------------|---------|----|--------|
| 0331513694 | Ø7.5x11 | 32 | 00/006 |



VIDRO GLASS
VIDRIO
VERRE



CANECA GALÃO VELA
mug jarra tasse

| REF | (cm) | CL | |
|------------|---------|----|--------|
| 0331595201 | Ø7.5x11 | 25 | 01/012 |



NOVO new

VIDRO GLASS
VIDRIO
VERRE



COPO GALÃO
tumbler vaso gobélet

| REF | (cm) | CL | |
|------------|-----------|----|--------|
| 0331010422 | Ø7.3x10.8 | 22 | 00/012 |
| 0331012004 | Ø5.5x8.9 | 10 | 00/012 |



VIDRO GLASS
VIDRIO
VERRE



CHÁVENA/PIRES CAFÉ VELA
coffee cup / saucer taza café / platillo tasse café / soucoupe

| REF | (cm) | CL | |
|------------|--------|------|--------|
| 0331597302 | Ø8.5x7 | 19.5 | 00/006 |
| 0331597301 | Ø6x5.5 | 8 | 00/006 |

Pires saucer platillo soucoupe **Ø13.5**



VIDRO GLASS
VIDRIO
VERRE



CHÁVENA/PIRES ALMOÇO BASIC
lunch cup / saucer
taza almuerzo / platillo
tasse déjeuner / soucoupe

| REF | (cm) | CL | |
|------------|--------|------|--------|
| 0331597948 | Ø9x6.5 | 23.8 | 00/006 |

Pires saucer platillo soucoupe **Ø13.5**

VIDRO GLASS
VIDRIO
VERRE



PIRES
saucer platillo soucoupe

| REF | (cm) | |
|------------|------|--------|
| 0331594381 | Ø13 | 06/072 |



VIDRO GLASS
VIDRIO
VERRE

METAL



CANECA C/TAMPA
mug with lid jarra con tapa tasse avec couvercle

| REF | (cm) | CL | |
|-------------|--------------|----|--------|
| 03324461371 | 1 7.5x7.5x13 | 45 | 00/036 |
| 0332446137 | 2 7.5x7.5x13 | 45 | 00/036 |

com tampa perfurada
with lid in punched
con tapa perforada
avec couvercle perforé

palhinha 19cm
straw 19cm
bajita 19cm
paille 19cm



VIDRO GLASS
VIDRIO
VERRE

METAL

PACK 4

CANECA C/TAMPA
mug with lid jarra con tapa tasse avec couvercle

| REF | (cm) | CL | |
|------------|-----------|----|--------|
| 0333793226 | 7.5x7.5x9 | 20 | 01/008 |

com tampa perfurada
with lid in punched
con tapa perforada
avec couvercle perforé



VIDRO GLASS
VIDRIO
VERRE

METAL

GARRAFA C/TAMPA
bottle with lid botella con tapa bouteille avec couvercle

| REF | (cm) | CL | |
|------------|--------|----|--------|
| 0332445107 | 6x6x19 | 45 | 00/048 |

VIDRO GLASS
VIDRIO
VERRE

METAL



GARRAFA BASIC
bottle botella bouteille

| REF | (cm) | CL | |
|------------|---------|-----|--------|
| 0331590346 | Ø6.5x26 | 50 | 01/006 |
| 0331590326 | Ø8x31 | 100 | 01/006 |



TAÇA ALTA C/PÉ
bowl copa coupe

| REF | (cm) | CL | |
|------------|-------|----|--------|
| 0730262313 | Ø8x19 | 42 | 36/072 |



TAÇA ARTIC
bowl copa coupe

| REF | (cm) | CL | |
|------------|-----------|------|--------|
| 0331591128 | Ø8.2x18.8 | 29.4 | 06/012 |



TAÇA GELADO CANADÁ
bowl copa coupe

| REF | (cm) | CL | |
|------------|------------|------|--------|
| 0331591078 | Ø11.6x13 | 13.5 | 06/048 |
| 0331591068 | Ø11.6x11.8 | 16 | 00/006 |



TAÇA GELADO GLACÉ
bowl copa coupe

| REF | (cm) | CL | |
|------------|----------|----|--------|
| 0331518929 | Ø10x12.3 | 21 | 06/024 |



TAÇA GELADO ICE VILLE
bowl copa coupe

| REF | (cm) | CL | |
|------------|---------------|------|--------|
| 0331591076 | Ø5.7x11.5x9.9 | 26.5 | 02/010 |



TAÇA GELADO ICE VILLE
bowl copa coupe

| REF | (cm) | CL | |
|------------|-----------|------|--------|
| 0331594041 | Ø10.7x9x9 | 18.5 | 01/024 |



TAÇA GELADO ICE VILLE
bowl copa coupe

| REF | (cm) | CL | |
|------------|---------|------|--------|
| 0331591368 | Ø7x10x8 | 17.4 | 06/024 |



TAÇA GELADO ICE VILLE
bowl copa coupe

| REF | (cm) | CL | |
|------------|---------------|------|--------|
| 0331590336 | 1 Ø9.5x10 | 26 | 01/024 |
| 0331591026 | 2 Ø9.6x8.1 | 25.5 | 03/024 |
| 0331591016 | 3 Ø6.5x10x8.1 | 26.5 | 06/036 |





NOVO
new



TAÇA GELADO FUNCHAL
bowl copa coupe

| REF | (cm) | CL | |
|------------|------|----|--------|
| 0331012038 | Ø9x8 | 16 | 00/012 |



TAÇA GELADO SORBET
bowl copa coupe

| REF | (cm) | CL | |
|------------|-------|----|--------|
| 0331510998 | Ø10x8 | 22 | 00/036 |



TAÇA SOBREMESA SEYCHELLES
bowl copa coupe

| REF | (cm) | CL | |
|------------|-----------|----|--------|
| 0331514741 | Ø10.5x7.7 | 22 | 06/192 |



TAÇA SOBREMESA PALMIER
bowl copa coupe

| REF | (cm) | CL | |
|------------|--------|----|--------|
| 0331510110 | Ø12x10 | 21 | 01/024 |



TAÇA FUSION
bowl copa coupe

| REF | (cm) | CL | |
|------------|--------|----|--------|
| 0333750478 | Ø7.5x7 | 25 | 01/012 |



TAÇA ONDULATO
bowl copa coupe

| REF | (cm) | CL | |
|------------|---------|----|--------|
| 0333750476 | Ø7.5x11 | 24 | 00/012 |



TAÇA SOBREMESA
bowl copa coupe

| REF | (cm) | CL | |
|------------|-----------|----|--------|
| 0733639277 | Ø9.5x10.5 | 18 | 12/096 |



TAÇA SOBREMESA
bowl copa coupe

| REF | (cm) | CL | |
|------------|------------|----|--------|
| 0733639234 | Ø13.7x13.3 | 25 | 04/016 |



TAÇA SOBREMESA
bowl copa coupe

| REF | (cm) | CL | |
|------------|------------|----|--------|
| 0733639255 | Ø11.3x13.3 | 40 | 00/036 |



TAÇA
bowl copa coupe

| REF | (cm) | CL | |
|-------------|------|---------|-------------|
| 0433654116 | 1 | Ø10 | 20 01/086 |
| 04339400092 | 2 | Ø9x6 | 17 06/120 |
| 0433651443 | 3 | Ø10x5.5 | 10 01/048 |
| 0432000702 | 4 | Ø10x11 | 17.5 01/072 |



mesa table mesa table



TAÇA SOUFLÉ
bowl copa coupe

| REF | (cm) | CL | |
|------------|----------|----|--------|
| 0331599106 | Ø8.3x5.9 | 22 | 01/042 |



TAÇA CREME CARMEL
bowl copa coupe

| REF | (cm) | CL | |
|------------|--------|----|--------|
| 0331599116 | Ø7x6.5 | 13 | 01/024 |

Paşabahçe



TAÇA PUDIM
bowl copa coupe

| REF | (cm) | CL | |
|------------|----------|------|--------|
| 0331593298 | Ø9.2x5.8 | 17.8 | 00/024 |

Paşabahçe



RAMEQUIM
ramekin ramequin ramequin

| REF | (cm) | CL | |
|------------|------|--------|-----------|
| 0331599624 | 1 | Ø10x5 | 24 01/024 |
| 0331593943 | 2 | Ø8x4.5 | 13 06/048 |

Paşabahçe



SALADEIRA KARAMAN
salad bowl ensaladera saladier

| REF | (cm) | CL | |
|------------|---------|----|--------|
| 0331593523 | Ø10.5x6 | 26 | 06/048 |

Paşabahçe

PACK 6



SALADEIRA VENEZIA
salad bowl ensaladera saladier

| REF | (cm) | CL | |
|------------|-------|----|--------|
| 0331593753 | Ø13x8 | 43 | 06/024 |

Paşabahçe

1



2



SALADEIRA OPHELIA
salad bowl ensaladera saladier

| REF | (cm) | CL | |
|------------|------|----------|------------|
| 0331593653 | 1 | Ø26x14.5 | 320 01/004 |
| 0331593643 | 2 | Ø12.5 | 40 06/024 |

Paşabahçe



SALADEIRA CITY
salad bowl ensaladera saladier

| REF | (cm) | CL | |
|------------|-----------|----|--------|
| 0331593142 | Ø12.5x5.6 | 30 | 06/048 |



Paşabahçe



empilhável
stackable
apilable
empilable

SALADEIRA QUADRADA
salad bowl ensaladera saladier

| REF | (cm) | CL | |
|------------|---------|----|--------|
| 0331593113 | 11x11x6 | 30 | 06/048 |



empilhável
sfackable
apilable
empilable

TAÇA RABANERA
salad bowl ensaladera saladier

| REF | (cm) | |
|------------|----------|--------|
| 0331517274 | 14x9x3.7 | 03/024 |



SALADEIRA PUDDING
salad bowl ensaladera saladier

| REF | (cm) | |
|------------|-----------|--------|
| 0331593662 | 11x11x4.5 | 01/024 |



PACK 18



11.2x9.7x5cm

Ø9.5x4.5cm

Ø8.8x4cm

SALADEIRA GASTROBOUTIQUE
salad bowl ensaladera saladier

| REF | (cm) | |
|------------|------|--------|
| 0331596431 | - | 01/024 |



PACK 6



Ø9.5x4.5cm

Ø8.8x4cm

12x5.8x2.5cm

SALADEIRA GASTROBOUTIQUE
salad bowl ensaladera saladier

| REF | (cm) | |
|------------|------|--------|
| 0331596450 | - | 04/006 |



PACK 6



Ø11x4.5cm

Ø7.7x3.2cm

SALADEIRA GASTROBOUTIQUE
salad bowl ensaladera saladier

| REF | (cm) | |
|------------|------|--------|
| 0331596447 | - | 01/004 |

mesa table mesa table



empilhável
stackable
apilable
empilable

*vidro temperado tempered glass
vidrio templado verre trempé

SALADEIRA CHEF'S
salad bowl ensaladera saladier

| REF | (cm) | CL | |
|------------|-------------|-----|--------|
| 0331593923 | Ø30x12.6* | 600 | 01/002 |
| 0331593593 | Ø26.2x11.3* | 400 | 00/006 |
| 0331593583 | Ø23x10.1 | 300 | 00/006 |
| 0331593573 | Ø20x8.7* | 200 | 00/012 |
| 0331593553 | Ø14x6.3 | 100 | 06/036 |
| 0331593543 | Ø12.5x5.3 | 30 | 00/012 |
| 0331593493 | Ø10.5x4.5* | 2 | 06/048 |
| 0331593483 | Ø9x3.7 | 3 | 00/024 |
| 0331593713 | Ø6x2.7 | 3.5 | 01/024 |



empilhável
stackable
apilable
empilable

SALADEIRA
salad bowl ensaladera saladier

| REF | (cm) | CL | |
|------------|--------|-----|--------|
| 0730261000 | Ø26x11 | 300 | 00/024 |



empilhável
stackable
apilable
empilable



SALADEIRA
salad bowl ensaladera saladier

| REF | (cm) | CL | |
|------------|----------|-----|--------|
| 0331514268 | Ø26x12 | 410 | 01/006 |
| 0331513113 | Ø23x10.5 | 280 | 01/006 |
| 0331513112 | Ø20x9 | 118 | 01/006 |
| 0331510275 | Ø17x7.8 | 110 | 01/024 |
| 0331514227 | Ø14x6.5 | 60 | 01/024 |
| 0331512277 | Ø12x5.5 | 35 | 01/036 |
| 0331510019 | Ø10x4.7 | 20 | 01/036 |
| 0331515018 | Ø9x4.1 | 15 | 01/036 |
| 0331515026 | Ø7x3.5 | 7.5 | 01/036 |
| 0331514193 | Ø6x2.7 | 3.5 | 01/036 |



empilhável
stackable
apilable
empilable

SALADEIRA
salad bowl ensaladera saladier

| REF | (cm) | |
|------------|------|--------|
| 0732960301 | Ø29 | 01/014 |



SALADEIRA
salad bowl ensaladera saladier

| REF | (cm) | CL | |
|-------------|---------|-----|--------|
| 07302610001 | Ø26x11 | 300 | 05/024 |
| 0730260900 | Ø23x10 | 200 | 03/048 |
| 07302606001 | Ø14x6.3 | 45 | 05/096 |
| 0730260500 | Ø12x5.3 | 30 | 06/192 |



empilhável
stackable
apilable
empilable



TAMPA BASCULANTE P/SALADEIRA
cover for salad bowl
tapa para ensaladera
couverture avec saladier

| REF | (cm) | |
|------------|---------|--------|
| 0732960300 | Ø29x1.5 | 00/030 |
| 0732960298 | Ø26x1.5 | 00/024 |
| 0732960296 | Ø23x1.5 | 00/024 |





PRATO TOKIO
plate plato plat

| REF | (cm) | |
|------------|-----------|--------|
| 0331594087 | 26.5x26.5 | 06/024 |
| 0331594077 | 19.5x19.5 | 06/024 |



PRATO FUNDO TOKIO
bottle botella bouteille

| REF | (cm) | |
|------------|-------|--------|
| 0331594633 | 19x19 | 06/024 |



SALADEIRA TOKIO
salad bowl ensaladera saladier

| REF | (cm) | |
|------------|---------------|--------|
| 0331593076 | 24x24x10.5 | 01/024 |
| 0331593083 | 12.5x12.5x5.1 | 01/024 |



PRATO BOLO PATISSERIE
cake plate plato torta plat gâteau

| REF | (cm) | |
|------------|---------|--------|
| 0331590345 | Ø32x1.6 | 01/013 |

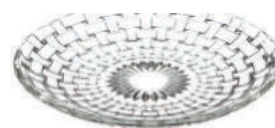

FRUTEIRO
fruit bowl frutero bol de fruits

| REF | (cm) | |
|------------|------|--------|
| 0332445424 | 32x4 | 01/012 |



FRASCO BELLA
bottle botella bouteille

| REF | (cm) | CC | |
|------------|--------------|------|--------|
| 0331590002 | 10.4x10.5x17 | 2000 | 06/012 |



FRASCO
bottle botella flacon

| REF | (cm) | LT | |
|------------|--------|-----|--------|
| 0332441083 | Ø14x20 | 1.5 | 06/012 |



FRASCO
bottle botella flacon

| REF | (cm) | LT | |
|-------------|----------|----|--------|
| 0332445123 | Ø17.5x30 | 5 | 01/006 |
| 03324451231 | Ø22x35 | 10 | 01/004 |



FRASCOS
bottles botellas flacons

| REF | (cm) | CL | |
|-------------|-------|----|---------|
| 03324450912 | 6.5x7 | 10 | 6 PACKS |



FRASCOS
bottles botellas flacons

| REF | (cm) | CL | |
|------------|--------|----|---------|
| 0332445091 | Ø4.5x8 | 7 | 6 PACKS |



FRASCOS
bottles botellas flacons

| REF | (cm) | CL | |
|-------------|---------|----|---------|
| 03324450911 | 5x5x8.5 | 7 | 6 PACKS |





NOVO
new



TALHERES
cutlery cubiertos *coutellerie*



TALHERES made in PORTUGAL

cutlery made in PORTUGAL
cubiertos fabricados en Portugal
coutellerie fabriqué au PORTUGAL

Artigos fundamentais para a apresentação numa mesa. Para além da sua funcionalidade, criam ambientes e estilos contemporâneos ou especiais, dando vida e originalidade à sua mesa.

Key articles for presentation at a table. In addition to their functionality, they create ambiances and styles contemporary or special, giving life and originality to your table.

Artículos fundamentales para la presentación en una mesa. Además de su funcionalidad, crean ambientes y estilos contemporáneos o especiales, dando vida y originalidad a su mesa.

Articles clés à présenter à une table. En plus de leur fonctionnalité, ils créent des ambiances et des styles contemporains ou spéciaux, donnant vie et originalité à votre table.



MODELO HOTEL

| | REF | (cm) | |
|--|------------|------|--------|
| FACA MESA dinner knife cuchillo mesa couteau de table | 0432942001 | 20.5 | 01/006 |
| GARFO MESA dinner fork tenedor mesa fourchette de table | 0432942002 | 19.3 | 01/006 |
| COLHER MESA dinner spoon cuchara mesa cuillère de table | 0432942003 | 19.5 | 01/006 |
| FACA S/MESA dessert knife cuchillo postre couteau à dessert | 0432942004 | 18.2 | 01/006 |
| GARFO S/MESA dessert fork tenedor postre fourchette à dessert | 0432942005 | 17.1 | 01/006 |
| COLHER S/MESA dessert spoon cuchara postre cuillère à dessert | 0432942006 | 14 | 01/006 |
| COLHER CHÁ teaspoon cuchara té cuillère à thé | 0432942007 | 12.6 | 01/006 |
| COLHER CAFÉ coffee spoon cuchara café cuillère à café | 0432942008 | 10.9 | 01/006 |



MODELO LISO II

| | REF | (cm) | |
|--|------------|------|--------|
| FACA MESA dinner knife cuchillo mesa couteau de table | 0432844501 | 20.5 | 01/006 |
| GARFO MESA dinner fork tenedor mesa fourchette de table | 0432844503 | 18.8 | 01/006 |
| COLHER MESA dinner spoon cuchara mesa cuillère de table | 0432844502 | 18.7 | 01/006 |
| FACA S/MESA dessert knife cuchillo postre couteau à dessert | 0432844504 | 17.7 | 01/006 |
| GARFO S/MESA dessert fork tenedor postre fourchette à dessert | 0432844506 | 15.6 | 01/006 |
| COLHER S/MESA dessert spoon cuchara postre cuillère à dessert | 0432844505 | 15.3 | 01/006 |
| COLHER CHÁ teaspoon cuchara té cuillère à thé | 0432844509 | 13 | 01/006 |
| COLHER CAFÉ coffee spoon cuchara café cuillère à café | 0432844510 | 11.5 | 01/006 |



MODELO 211L-V

| | REF | (cm) | |
|---|------------|------|--------|
| FACA MESA CHAPA dinner knife cuchillo mesa couteau de table | 0432844507 | - | 01/006 |





MODELO EUROPA

| | REF | (cm) | |
|---|------------|------|--------|
| FACA MESA dinner knife cuchillo mesa couteau de table | 0432949001 | 21.4 | 01/006 |
| GARFO MESA dinner fork tenedor mesa fourchette de table | 0432949002 | 19.5 | 01/006 |
| COLHER MESA dinner spoon cuchara mesa cuillère de table | 0432949003 | 20 | 01/006 |
| FACA S/MESA dessert knife cuchillo postre couteau à dessert | 0432949004 | 19.5 | 01/006 |
| GARFO S/MESA dessert fork tenedor postre fourchette à dessert | 0432949005 | 16.9 | 01/006 |
| COLHER S/MESA dessert spoon cuchara postre cuillère à dessert | 0432949006 | 17 | 01/006 |
| FACA PEIXE fish knife cuchillo pescado couteau à poisson | 0432949007 | 21.5 | 01/006 |
| GARFO PEIXE fish fork tenedor pescado fourchette à poisson | 0432949008 | 19.7 | 01/006 |
| COLHER CHÁ teaspoon cuchara té cuillère à thé | 0432949009 | 13.1 | 01/006 |
| COLHER CAFÉ coffee spoon cuchara café cuillère à café | 0432949010 | 11.1 | 01/006 |
| ESPÁTULA MANTEIGA butter knife cuchillo de mantequilla couteau à beurre | 0432949011 | 13.3 | 01/006 |
| FACA P/BIFE steak knife cuchillo de carne couteau à steak | 0432949015 | 21.2 | 01/006 |



MODELO MARIA

| | REF | (cm) | |
|---|------------|---------|--------|
| FACA MESA dinner knife cuchillo mesa couteau de table | 0432941100 | 22.2 | 01/006 |
| GARFO MESA dinner fork tenedor mesa fourchette de table | 0432941101 | 20.1 | 01/006 |
| COLHER MESA dinner spoon cuchara mesa cuillère de table | 0432941102 | 20.3 | 01/006 |
| FACA S/MESA dessert knife cuchillo postre couteau à dessert | 0432941103 | 19.6 | 01/006 |
| GARFO S/MESA dessert fork tenedor postre fourchette à dessert | 0432941104 | 17.7 | 01/006 |
| COLHER S/MESA dessert spoon cuchara postre cuillère à dessert | 0432941105 | 17.8 | 01/006 |
| FACA PEIXE fish knife cuchillo pescado couteau à poisson | 0432941107 | 20.4 | 01/006 |
| GARFO PEIXE fish fork tenedor pescado fourchette à poisson | 0432941106 | 18.2 | 01/006 |
| COLHER CHÁ teaspoon cuchara té cuillère à thé | 0432941109 | 14 | 01/006 |
| COLHER CAFÉ coffee spoon cuchara café cuillère à café | 0432941110 | 10.7 | 01/006 |
| CONCHA ladle cacillo louche | 0432941112 | Ø8.7x28 | 01/006 |
| COLHER ARROZ rice spoon cuchara arroz cuillère à riz | 0432941111 | 25.2 | 01/006 |
| FACA CHURRASCO barbecue knife cuchillo barbacoa couteau de barbecue | 0432941119 | 22 | 01/006 |



MODELO PARIS

| | REF | (cm) | |
|---|------------|-------|--------|
| FACA MESA dinner knife cuchillo mesa couteau de table | 0432943001 | 22 | 01/006 |
| GARFO MESA dinner fork tenedor mesa fourchette de table | 0432943002 | 20.1 | 01/006 |
| COLHER MESA dinner spoon cuchara mesa cuillère de table | 0432943003 | 20.2 | 01/006 |
| FACA S/MESA dessert knife cuchillo postre couteau à dessert | 0432943004 | 19.4 | 01/006 |
| GARFO S/MESA dessert fork tenedor postre fourchette à dessert | 0432943005 | 16.7 | 01/006 |
| COLHER S/MESA dessert spoon cuchara postre cuillère à dessert | 0432943006 | 18 | 01/006 |
| FACA PEIXE fish knife cuchillo pescado couteau à poisson | 0432943013 | 20.5 | 01/006 |
| GARFO PEIXE fish fork tenedor pescado fourchette à poisson | 0432943014 | 18.3 | 01/006 |
| FACA P/BIFE steak knife cuchillo de carne couteau à steak | 0432943012 | 22.2 | 01/006 |
| COLHER CHÁ teaspoon cuchara té cuillère à thé | 0432943007 | 13.8 | 01/006 |
| COLHER CAFÉ coffee spoon cuchara café cuillère à café | 0432943008 | 10.3 | 01/006 |
| COLHER ARROZ rice spoon cuchara arroz cuillère à riz | 0432943010 | 25.8 | 01/006 |
| COLHER TERRINA rice spoon cuchara arroz cuillère à riz | 0432943011 | Ø9x28 | 01/006 |
| GARFO TRINCHAR meat carving fork tenedor para carne fourchette à viande | 0432943009 | 25 | 01/006 |
| PÁ PUDIM eggs server servidor de huevos serveur d'oeufs | 0432943015 | 25.5 | 01/006 |
| FACA MANTEIGA butter knife cuchillo de mantequilla couteau à beurre | 0432943016 | 15.2 | 01/006 |



CÁLICES/COPOS

tumblers/glasses vasos/tazas verres/tasses





CÁLICES GOBLETS COPAS VERRES À PIED

Numa degustação de vinhos, o copo tem um papel muito importante. Um bom copo consegue aumentar e evidenciar os atributos do vinho. Deve ter sempre em especial atenção a escolha do tipo de copo para servir uma bebida específica.

Na degustação de vinhos, devem ser utilizados copos de longa aste e de espessura adequada, para que possa manusear o copo sem que o vinho sofra alterações de temperatura.

Um vinho de tinto austero e muito envelhecido requer um copo com um bojo grande e um bocal ligeiramente mais pequeno do que o bojo. O copo deve ser enchido até metade para poder evoluir integralmente.

Os vinhos brancos sápidos, os tintos jovens e os clássicos vinhos tintos medianamente envelhecidos, requerem um copo mais esguio no bojo e devem ser servidos até metade do seu volume.

Os vinhos brancos e frisantes devem ser servidos num copo alongado de forma a evidenciar o seu aroma.

Os rosés devem ser servidos em copos levemente arredondados no bojo e pouco altos.

Para o champanhe, se este for seco, deve ser servido num copo muito alongado, enquanto que os espumantes doces devem ser servidos em taças.

O licor e o vinho do Porto devem ser servidos em copos pequenos que se estreitam no bocal para conservar os aromas.

In a wine tasting, the glass plays a very important role. A good glass can increase and highlight the attributes of wine. Particular attention should always be paid to the choice of the type of glass to serve a specific beverage.

In wine tasting, long-stemmed glasses of suitable thickness must be used, so that you can handle the glass without the wine undergoing temperature changes.

An austere and very aged red wine requires a glass with a large bulge and a slightly smaller mouth than the bulge. The glass should be filled halfway in order to fully evolve.

Sophisticated white wines, young reds and classic red aged wines, require a lighter glass in the bottle and should be served to half their volume.

The white and semi-sparkling wines should be served in an elongated glass in order to show its aroma.

The rosés should be served in cups slightly rounded in the bulge and not very high.

For the champagne, if it is dry, it should be served in a very elongated glass, whereas the sparkling wines should be served in glasses.

Liquor and Port wine should be served in small glasses that narrow into the mouthpiece to conserve the aromas.

En degustação de vinho, o vidro tem um papel muito importante. Um bom vaso pode melhorar e destacar os atributos do vinho. Sempre se deve prestar especial atenção à escolha do tipo de vidro para servir uma bebida específica.

En cata, se devem usar taças largas e de espessura adequada, de modo que possa manejar o vidro sem que o vinho se submeta a mudanças de temperatura.

Um vinho tinto envelhecido austero e requer um vaso com um recipiente grande e uma boquilha ligeiramente mais pequena do que o bulto. O vidro deve encher-se até à metade para poder desenvolver-se plenamente.

Os sápidos vinhos brancos, rosados jovens e vinhos clássicos medianamente roxo envelhecido, requerem um vaso mais delgado no núcleo e se devem servir à metade do seu volume.

Os vinhos brancos e espumosos se devem servir em um vaso longo com o fim de ressaltar o seu aroma.

Rosado se deve servir em copos ligeiramente arredondados no ventre e pouco altos.

Para o champán, se este for seco, deve ser servido em um vaso muito alongado, enquanto que os espumosos doces devem ser servidos em taças.

O licor e o vinho do Porto devem ser servidos em vasos pequenos que reduzem a boquilha para preservar os aromas.

Dans une dégustation de vin, le verre a un rôle très important. Un bon verre peut améliorer et mettre en valeur les attributs du vin. Vous devez toujours accorder une attention particulière au choix du type de verre pour servir une boisson spécifique.

Pour mieux déguster un vin, un verre à longue tige et d'épaisseur adéquate doit être utilisé afin de le manier sans que le vin souffre quelconque changement de température.

Un vin vieux rouge austère nécessite d'un verre avec des parois en rondeur pour aérer le vin en souplesse et une forme ovoïde qui doit être à moitié rempli.

Les vins blancs savoureux, les rouges jeunes et les vins juste vieux classiques exigent un verre plus haut et plus effilé à moitié rempli pour que le vin se dévoile.

Les vins blancs et mousseux doivent être servis dans un verre long afin de faire ressortir rapidement les arômes.

Le Rosé doit être servi dans un verre légèrement arrondi et moins haut.

Quant au Champagne, s'il est Brut, il doit être servi dans un verre très allongé, tandis que s'il est doux, il doit être servi dans des coupes.

Les liqueurs et le vin de Porto doivent être servis dans de petits verres de petite dimension évasés pour une meilleure conservation des arômes.





Luminarc



CÁLICE VINA JULIETTE
glass copa verre

| REF | (cm) | CL | |
|------------|------------------------|----|--------|
| 0331515993 | Ø9x22 | 50 | 01/006 |
| 0331514907 | Ø8.5x21 | 40 | 01/006 |
| 0331515082 | FLUTE Ø6.5x21.7 | 23 | 06/024 |

COPO VINA JULIETTE FA
tumbler vaso gobelet

| REF | (cm) | CL | |
|------------|-------|----|--------|
| 0331515994 | Ø8x11 | 40 | 01/006 |

mesa table mesa table



CÁLICE MENCIA
glass copa verre



| REF | (cm) | CL | |
|------------|----------------------|----|--------|
| 0333750265 | Ø9.1x23.5 | 58 | 01/006 |
| 0333750264 | Ø8.6x23 | 44 | 01/006 |
| 0333750263 | Ø7.7x20.8 | 31 | 01/006 |
| 0333750262 | Ø7.2x19.2 | 25 | 01/030 |
| 0333750290 | FLUTE Ø6x22.1 | 17 | 01/006 |

COPO MENCIA
tumbler vaso gobelet

| REF | (cm) | CL | |
|------------|---------|----|--------|
| 0333751854 | Ø8.5x11 | 47 | 01/006 |
| 0333751853 | Ø8x9.5 | 35 | 01/006 |



Pasabahçe



CÁLICE ALLEGRA
glass copa verre

| REF | (cm) | CL | |
|------------|------------------------|------|--------|
| 0331590065 | Ø7.8x21.8 | 46 | 00/012 |
| 0331590080 | Ø7.5x21.8 | 34.5 | 00/012 |
| 0331590079 | FLUTE Ø4.5x22.6 | 19.5 | 00/006 |

COPO ALLEGRA
tumbler vaso gobelet

| REF | (cm) | CL | |
|------------|---------|------|--------|
| 0331591536 | Ø6.8x11 | 43.5 | 06/024 |



CÁLICES/COPOS

tumblers/glasses vasos/tazas verres/tasses



CÁLICE PINOT
glass copa verre

| REF | (cm) | CL | |
|------------|-----------|----|--------|
| 0333750216 | Ø8.7x22.1 | 47 | 00/012 |
| 0333750215 | Ø8x20.2 | 35 | 00/012 |
| 0333750214 | Ø7.1x18.2 | 25 | 00/012 |



CÁLICE PINOT AFERIDO
glass copa verre

| REF | (cm) | CL | |
|-------------|-----------|------------|--------|
| 03337502161 | Ø8.7x22.1 | 47 AF.15 | 00/012 |



COPO PINOT FA
tumbler vaso gobelet

| REF | (cm) | CL | |
|------------|-----------|----|--------|
| 0333750242 | Ø8.7x10.9 | 47 | 00/006 |
| 0333750243 | Ø7.9x9 | 35 | 00/006 |



CÁLICE VINTAGE
glass copa verre



| REF | (cm) | CL | |
|------------|-----------|----|--------|
| 0333750758 | Ø8.8x20.5 | 42 | 01/006 |
| 0333750757 | Ø8x19.7 | 32 | 01/006 |
| 0333750756 | Ø7.4x18.7 | 25 | 01/006 |



CÁLICE DREAM
glass copa verre

| REF | (cm) | CL | |
|------------|----------------------|------|--------|
| 0331594571 | Ø8.5x26 | 67 | 02/024 |
| 0331594561 | Ø8x23.9 | 50 | 02/024 |
| 0331594581 | Ø8x22.5 | 38 | 02/024 |
| 0331594591 | FLUTE Ø7x24.4 | 21.5 | 02/024 |



CÁLICE MONTECARLO
glass copa verre

| REF | (cm) | CL | |
|------------|------------------------|------|--------|
| 0331590088 | Ø6.7x20.6 | 44.5 | 06/024 |
| 0331590091 | Ø8x23.3 | 32.5 | 06/024 |
| 0331590090 | Ø7.7x21.5 | 26.5 | 06/024 |
| 0331590157 | FLUTE Ø7.5x25.2 | 22.5 | 00/024 |



CÁLICE AMBER
glass copa verre

| REF | (cm) | CL | |
|------------|-----------------------|----|--------|
| 0331590275 | Ø8.5x21.5 | 45 | 06/024 |
| 0331590265 | Ø8x20 | 35 | 06/024 |
| 0331590255 | Ø7.7x18.5 NOVO | 29 | 06/024 |

mesa table mesa table



CÁLICE CHIARA
glass copa verre

| REF | (cm) | CL | |
|------------|-----------|------|--------|
| 0331596059 | Ø6.5x21.6 | 51.5 | 06/024 |
| 0331596061 | Ø6x20.6 | 42 | 06/024 |
| 0331596060 | Ø5.7x19.7 | 32 | 06/024 |



CÁLICE ROMA
glass copa verre

| REF | (cm) | CL | |
|-------------|------------------------|----|--------|
| 03310164421 | Ø8x19 | 42 | 00/006 |
| 0331013364 | Ø8x18.3 | 34 | 00/006 |
| 0331016424 | Ø7.5x16.9 | 24 | 00/006 |
| 0331016420 | Ø6.2x15.5 | 20 | 00/006 |
| 0331016417 | FLUTE Ø6.9x21.5 | 17 | 00/006 |



CÁLICE V-LINE
glass copa verre

| REF | (cm) | CL | |
|------------|----------------------|------|--------|
| 0331594315 | Ø8.7x21 | 26 | 00/012 |
| 0331594325 | Ø7x20 | 20.8 | 00/012 |
| 0331594305 | FLUTE Ø7.5x24 | 20.4 | 00/012 |



CÁLICE LINEAL
glass copa verre

| REF | (cm) | CL | |
|------------|-----------|----|--------|
| 0331513570 | Ø8.2x19.7 | 31 | 06/024 |
| 0331513572 | Ø7.7x17.4 | 25 | 06/024 |
| 0331513571 | Ø7x16.5 | 19 | 06/024 |



CÁLICE SENSATION
glass copa verre

| REF | (cm) | CL | |
|------------|-----------|----|--------|
| 0331510959 | Ø8.8x20 | 38 | 06/024 |
| 0331513482 | Ø8.3x18.9 | 31 | 00/024 |
| 0331510958 | Ø7.9x17.8 | 27 | 00/012 |
| 0331510957 | Ø7.2x15.9 | 21 | 06/024 |



CÁLICE SENSATION EXALT
glass copa verre

| REF | (cm) | CL | |
|------------|--------------------|----|--------|
| 0331514209 | Ø8.6x20.5 | 41 | 06/024 |
| 0331514210 | Ø8x19.5 | 31 | 12/048 |
| 0331514211 | Ø7.4x18.5 | 25 | 06/024 |
| 0331514212 | Ø7x18 | 20 | 12/048 |
| 0331510960 | FLUTE Ø7x21 | 19 | 06/024 |



elegância e resistência

elegance and resistance
elegancia y resistencia
élégance et résistance



CÁLICES/COPOS

tumblers/glasses vasos/tazas verres/tasses



CÁLICE MODA
glass copa verre

| REF | (cm) | CL | |
|-------------|------------|------|--------|
| 0331590169 | Ø7.7x21 | 44 | 00/012 |
| 03315901680 | Ø7.85x19.8 | 32 | 00/004 |
| 0331590167 | Ø6.6x18.3 | 24.5 | 00/012 |
| 0331590168 | Ø6.9x19.7 | 20 | 00/004 |



CÁLICE BARONE
glass copa verre

| REF | (cm) | CL | |
|------------|------------------------|------|--------|
| 0330807056 | Ø8.5x22.3 | 49 | 00/012 |
| 0330807156 | Ø7x21 | 38.5 | 00/004 |
| 0330807856 | FLUTE Ø6.3x22.3 | 18 | 00/012 |



CÁLICE IMPERIAL
glass copa verre

| REF | (cm) | CL | |
|------------|----------------------|------|--------|
| 0331594272 | Ø7x18 | 34 | 03/024 |
| 0331594703 | Ø6.6x16.9 | 25.5 | 03/024 |
| 0331594705 | Ø6.6x16 | 19.8 | 02/012 |
| 0331594704 | FLUTE Ø6.4x21 | 21 | 03/012 |



CÁLICE CABERNET TULIPE
glass copa verre

| REF | (cm) | CL | |
|------------|----------------------|----|--------|
| 0331511197 | Ø9.5x23 | 58 | 00/006 |
| 0331511196 | Ø9x22 | 47 | 06/024 |
| 0331511195 | Ø8x20.2 | 35 | 00/006 |
| 0331511194 | Ø7.2x18 | 25 | 00/006 |
| 0331511771 | FLUTE Ø7x22.5 | 16 | 06/024 |



CÁLICE ENCHANTE - GRAN RESERVA
glass copa verre

| REF | (cm) | CL | |
|-------------|----------------------|----|--------|
| 0331516967 | Ø8x23 | 58 | 00/024 |
| 0331516965 | Ø8.5x22 | 47 | 00/024 |
| 03315169691 | Ø7.5x20.5 | 35 | 00/012 |
| 0331516968 | Ø7x18 | 26 | 00/024 |
| 0331516970 | FLUTE Ø5x22.5 | 16 | 00/006 |



CÁLICE MERLOT
glass copa verre

| REF | (cm) | CL | |
|------------|-----------|----|--------|
| 0333750097 | Ø8.5x20.9 | 42 | 00/012 |
| 0333750098 | Ø8x19.6 | 31 | 00/012 |
| 0333750099 | Ø7.5x17.4 | 23 | 00/012 |
| 0333750100 | Ø6.9x16.8 | 19 | 00/012 |



CÁLICE AIREN
glass copa verre

| REF | (cm) | CL | |
|------------|------------------------|----|--------|
| 0333750151 | Ø8x18.3 | 31 | 00/012 |
| 0333750152 | Ø7.5x15.1 | 23 | 00/012 |
| 0333750153 | Ø6.9x14 | 19 | 00/012 |
| 0333750154 | FLUTE Ø5.4x17.7 | 17 | 00/012 |





CÁLICE SAXON
glass copa verre

| REF | (cm) | CL | |
|------------|----------------------|------|--------|
| 0331594665 | Ø7.7x18.2 | 34 | 00/012 |
| 0331594655 | Ø7x15.5 | 24.5 | 00/012 |
| 0331594645 | Ø6.3x14.2 | 19 | 00/012 |
| 0331594675 | FLUTE Ø6x17.4 | 15.5 | 00/048 |



CÁLICE TULIPE
glass copa verre

| REF | (cm) | CL | |
|------------|------------------------|----|--------|
| 0331594162 | Ø7.5x17 | 32 | 12/024 |
| 0331594163 | Ø7x16.5 | 24 | 00/024 |
| 0331594167 | Ø6.6x15.5 | 20 | 00/012 |
| 0311594160 | FLUTE Ø6.5x20.5 | 20 | 06/024 |



CÁLICE SAVOIE
glass copa verre

| REF | (cm) | CL | |
|------------|--------------------|------|--------|
| 0331512184 | Ø8.4x18.3 | 35 | 06/048 |
| 0331517778 | Ø7.5x15.2 | 24.5 | 12/048 |
| 0331517786 | Ø6.9x14 | 19 | 12/048 |
| 0331517794 | Ø6.4x13.4 | 14.5 | 12/048 |
| 0331519212 | Ø5.9x11.5 | 12 | 12/048 |
| 0331517810 | FLUTE Ø8x17 | 17 | 12/048 |



CÁLICE BANQUETE
glass copa verre

| REF | (cm) | CL | |
|------------|----------------------|------|--------|
| 0331594445 | Ø8.4x13.7 | 25.5 | 00/012 |
| 0331594435 | Ø7.6x12.8 | 19.5 | 00/012 |
| 0331594425 | Ø6x12.2 | 15.5 | 00/012 |
| 0331594455 | FLUTE Ø6x15.8 | 15.5 | 00/012 |



CÁLICE VALON
glass copa verre

| REF | (cm) | CL | |
|------------|-----------|----|--------|
| 0333750067 | Ø8.3x13.8 | 25 | 00/012 |
| 0333750077 | Ø7.6x12.9 | 19 | 00/012 |
| 0333750089 | Ø7x11.8 | 15 | 00/012 |



CÁLICE PACOME
glass copa verre

| REF | (cm) | CL | |
|------------|----------------------|------|--------|
| 0331514042 | Ø6.8x15.2 | 25 | 06/024 |
| 0331514041 | Ø6.5x13.9 | 19 | 06/024 |
| 0331514043 | FLUTE Ø6x15.6 | 14.5 | 06/024 |



CÁLICES/COPOS

tumblers/glasses vasos/tazas verres/tasses

Luminarc



CÁLICE BALLON
glass copa verre

| REF | (cm) | CL | |
|------------|-----------|----|--------|
| 0331512068 | Ø8.3x13.8 | 25 | 12/072 |
| 0331511052 | Ø7.6x7.6 | 19 | 01/012 |
| 0331512268 | Ø7.1x11.8 | 15 | 01/012 |
| 0331518876 | Ø6.2x10.2 | 10 | 01/012 |

Paşabahçe



CÁLICE TOWER
glass copa verre

| REF | (cm) | CL | |
|------------|-----------|------|--------|
| 0331594074 | Ø7.6x12.3 | 39 | 00/012 |
| 0331594044 | Ø7x11.2 | 21.5 | 00/012 |
| 0331594034 | Ø6.5x10.4 | 17.5 | 00/012 |



empilhável
stackable
apilable
empilable



CRISAL



**NOVO
new**



CÁLICE GEMINI
glass copa verre

| REF | (cm) | CL | |
|------------|-----------|----|--------|
| 0331013301 | Ø7x13.5 | 28 | 00/006 |
| 0331013302 | Ø6.5x11.8 | 19 | 00/006 |

VICRILA



CÁLICE CATAVINOS
glass copa verre

| REF | (cm) | CL | |
|------------|-----------|------|--------|
| 0333750247 | Ø6.5x15.5 | 21 | 00/006 |
| 0333750246 | Ø5.8x15.1 | 15.5 | 00/006 |

Paşabahçe



CÁLICE CATAVINHOS
glass copa verre

| REF | (cm) | CL | |
|------------|-----------|----|--------|
| 0331590037 | Ø6.6x15.5 | 24 | 00/012 |

Arcoroc
Serving solutions



CÁLICE VITICOLE PORTO
glass copa verre

| REF | (cm) | CL | |
|------------|-----------|------|--------|
| 0331517266 | Ø6.5x15.5 | 21.5 | 00/006 |
| 0331510304 | Ø5.3x13 | 12 | 00/006 |

Paşabahçe



CÁLICE CASABLANCA
glass copa verre

| REF | (cm) | CL | |
|------------|-----------|------|---------|
| 0331591268 | Ø8.9x17.3 | 32 | 03//024 |
| 0331591258 | Ø8x16 | 24.5 | 03/024 |



mesa table



CÁLICE NORMANDIE
glass copa verre

| REF | (cm) | CL | |
|------------|-----------|----|--------|
| 0331517811 | Ø7.4x16.2 | 23 | 06/024 |



CÁLICE EDINBURGH
glass copa verre

| REF | (cm) | CL | |
|------------|------------|----|--------|
| 0333750767 | Ø10.7x22.7 | 78 | 00/006 |



CÁLICE CABERNET LIRA
glass copa verre

| REF | (cm) | CL | |
|------------|-----------|----|--------|
| 0331511292 | Ø8.7x18.5 | 38 | 06/048 |



CÁLICE CHATEAU NOUVEAU
glass copa verre

| REF | (cm) | CL | |
|------------|---------|------|--------|
| 0331596009 | Ø8x20.5 | 48.5 | 06/024 |



CÁLICE ENCHNATE VINA
glass copa verre

| REF | (cm) | CL | |
|------------|---------|----|--------|
| 0331516968 | Ø7.2x18 | 26 | 00/024 |



FLUTE SIGNATURE
flute copa flauta flûte

| REF | (cm) | CL | |
|------------|---------|----|--------|
| 0331513146 | Ø5.5x22 | 17 | 06/024 |



FLUTE PRIMEUR
flute copa flauta flûte

| REF | (cm) | CL | |
|------------|---------|----|--------|
| 0331597009 | Ø4.9x21 | 20 | 06/024 |



CÁLICES/COPOS

tumblers/glasses vasos/tazas verres/tasses



COPO CHIQUE
tumbler vaso gobelet

| REF | (cm) | CL | |
|------------|-----------|----|--------|
| 0331594003 | Ø8.2x14.2 | 47 | 00/024 |
| 0331594002 | Ø7.7x12 | 33 | 00/006 |
| 0331594001 | Ø9x10 | 40 | 04/004 |



COPO ASKA
tumbler vaso gobelet

| REF | (cm) | CL | |
|------------|-----------|----|--------|
| 0331518508 | Ø8.2x14.2 | 45 | 00/006 |
| 0331518675 | Ø7.7x12 | 35 | 00/006 |
| 0331518507 | Ø9x10 | 38 | 00/006 |



COPO VIGNE
tumbler vaso gobelet

| REF | (cm) | CL | |
|------------|----------|----|--------|
| 0331513658 | Ø6x11 | 22 | 06/024 |
| 0331512370 | Ø9x8.5 | 37 | 06/024 |
| 0331513666 | Ø6.8x7.2 | 31 | 06/024 |



COPO LIMA
tumbler vaso gobelet

| REF | (cm) | CL | |
|------------|---------|----|--------|
| 0331512356 | Ø7.5x16 | 45 | 06/024 |
| 0331519328 | Ø8.8x11 | 38 | 06/024 |
| 0331513367 | Ø9.4x8 | 35 | 06/024 |



COPO SALTO
tumbler vaso gobelet

| REF | (cm) | CL | |
|------------|---------|----|--------|
| 0331512130 | Ø7.6x12 | 35 | 06/048 |
| 0331512129 | Ø9x8.4 | 32 | 06/048 |



COPO BARREL
tumbler vaso gobelet

| REF | (cm) | CL | |
|------------|-----------|------|--------|
| 0331591020 | Ø7.5x14.2 | 49.5 | 06/048 |



COPO PRIMARY FA
tumbler vaso gobelet

| REF | (cm) | CL | |
|------------|---------|----|--------|
| 0331515724 | Ø8x10.2 | 36 | 00/006 |





Paşabahçe



TAÇA MARTINI TIMELESS
glass copa verre

| REF | (cm) | CL | |
|------------|------------|----|--------|
| 0331590176 | Ø11.6x17.2 | 23 | 01/012 |

Paşabahçe



TAÇA CHAMPAGNE TIMELESS
glass copa verre

| REF | (cm) | CL | |
|------------|----------|------|--------|
| 0331590236 | Ø11x15.7 | 25.5 | 01/012 |

Paşabahçe



TAÇA COCKTAIL TIMELESS
glass copa verre

| REF | (cm) | CL | |
|------------|--------|----|--------|
| 0331590237 | Ø10x20 | 50 | 01/012 |

Paşabahçe



COPO WHISKY FB TIMELESS
glass copa verre

| REF | (cm) | CL | |
|------------|----------|------|--------|
| 0331592790 | Ø8.4x9.5 | 34.5 | 01/012 |

Paşabahçe



COPO LONG DRINK FH TIMELESS
glass copa verre

| REF | (cm) | CL | |
|------------|-----------|------|--------|
| 0331592820 | Ø6.2x14 | 29.5 | 01/024 |
| 0331592800 | Ø7.7x15.8 | 45 | 01/012 |

Paşabahçe



JARRO D/MISTURA TIMELESS
jug jarro pichet

| REF | (cm) | CL | |
|------------|-----------|------|--------|
| 0331592849 | Ø9.8x14.4 | 72.5 | 01/006 |



CÁLICE CABERNET BALLON
glass copa verre

| REF | (cm) | CL | |
|-------------|------------|----|--------|
| 0331511193 | Ø11.5x22 | 70 | 06/024 |
| 03315121192 | Ø10.6x20.9 | 58 | 06/024 |



CÁLICE PEAK
glass copa verre

| REF | (cm) | CL | |
|------------|-----------|----|--------|
| 0331514090 | Ø8.9x25.5 | 70 | 06/048 |



NOVO
new



CÁLICE COPACABANA
glass copa verre

| REF | (cm) | CL | |
|------------|----------|----|--------|
| 0331013658 | Ø11x19.4 | 60 | 00/006 |



CÁLICE IBIZA
glass copa verre

| REF | (cm) | CL | |
|------------|----------|----|--------|
| 0333751375 | Ø11x21.2 | 72 | 00/012 |



CÁLICE HAVANA
glass copa verre

| REF | (cm) | CL | |
|------------|------------|----|--------|
| 0333750093 | Ø10.8x19.5 | 62 | 00/006 |



TAÇA CAPRI COCKTAIL
glass copa verre

| REF | (cm) | CL | |
|------------|----------|------|--------|
| 0331594386 | Ø11.5x17 | 30.5 | 00/012 |



TAÇA MARGUERITA
glass copa verre

| REF | (cm) | CL | |
|------------|------------|----|--------|
| 0331597036 | Ø10.9x17.2 | 25 | 06/024 |





TAÇA MARGARITA
glass copa verre

| REF | (cm) | CL | |
|------------|------------|----|--------|
| 0333751066 | Ø10.8x16.5 | 27 | 00/012 |



TAÇA COCKTAIL FUSION
glass copa verre

| REF | (cm) | CL | |
|------------|----------|----|--------|
| 0331597012 | Ø11x18.3 | 20 | 06/012 |



TAÇA COCKTAIL BAR T TABLE
glass copa verre

| REF | (cm) | CL | |
|------------|-----------|----|--------|
| 0331597040 | Ø9.6x16.9 | 15 | 06/012 |



TAÇA ENOTECA MARTINI
glass copa verre

| REF | (cm) | CL | |
|------------|------------|------|--------|
| 0331594698 | Ø11.4x17.4 | 21.2 | 00/006 |



TAÇA COCKTAIL
glass copa verre

| REF | (cm) | CL | |
|------------|--------|----|--------|
| 0333750747 | Ø11x18 | 21 | 00/006 |



TAÇA SIGNATURE COCKTAIL
glass copa verre

| REF | (cm) | CL | |
|------------|-----------|----|--------|
| 0331511015 | Ø9.5x16.5 | 15 | 04/024 |



TAÇA CABERNET COCKTAIL
glass copa verre

| REF | (cm) | CL | |
|------------|------------|----|--------|
| 0331512972 | Ø11.6x17.2 | 21 | 00/006 |



COPO GRANITY
tumbler vaso gobelet



empilhável
stackable
apilable
empilable



| REF | (cm) | CL | |
|------------|-----------|----|--------|
| 0331511237 | Ø8.7x16 | 46 | 00/012 |
| 0331519903 | Ø8.5x12.2 | 35 | 00/012 |
| 0331519879 | Ø7.5x14 | 31 | 00/012 |
| 0331519875 | Ø6.4x12.7 | 20 | 00/012 |
| 0331511233 | Ø8.5x9.8 | 27 | 00/012 |



COPO NORVEGE
tumbler vaso gobelet



| REF | (cm) | CL | |
|------------|----------|----|--------|
| 0331510028 | Ø7.7x9.4 | 25 | 12/072 |
| 0331510024 | Ø7.2x8.8 | 20 | 06/072 |



empilhável
stackable
apilable
empilable



COPO SIENA
tumbler vaso gobelet



| REF | (cm) | CL | |
|------------|---------|------|--------|
| 0333752022 | Ø7.4x14 | 31.5 | 00/012 |

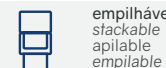

empilhável
stackable
apilable
empilable



COPO NEXT
tumbler vaso gobelet



| REF | (cm) | CL | |
|------------|-----------|----|--------|
| 0331592469 | Ø7.3x11.8 | 28 | 00/012 |
| 0331592459 | Ø7.2x8.4 | 20 | 00/012 |
| 0331592715 | Ø6.7x7.9 | 16 | 12/048 |

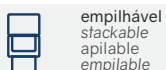

empilhável
stackable
apilable
empilable



COPO CASABLANCA
tumbler vaso gobelet



| REF | (cm) | CL | |
|------------|----------|------|--------|
| 0331592709 | Ø8.7x13 | 42.1 | 00/012 |
| 0331592718 | Ø7.4x14 | 31 | 00/012 |
| 0331592705 | Ø8.6x9.2 | 26.9 | 03/008 |

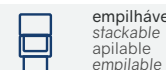

empilhável
stackable
apilable
empilable



COPO
tumbler vaso gobelet



| REF | (cm) | CL | |
|---------------------|---------|------|--------|
| 0333472012 1 | Ø8x14.8 | 37 | 00/004 |
| 0333470456 2 | Ø8x12 | 43.7 | 01/008 |
| 0333472011 3 | Ø7.7x12 | 31.4 | 06/072 |

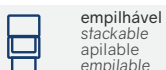

empilhável
stackable
apilable
empilable



COPO GRANADA FH
tumbler vaso gobelet



| REF | (cm) | CL | |
|------------|---------|----|--------|
| 0332242011 | Ø7.7x12 | 33 | 06/072 |

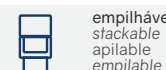

empilhável
stackable
apilable
empilable



empilhável
stackable
apilable
empilable



COPO DISCO LOUNGE
tumbler vaso gobelet

| REF | (cm) | CL | |
|------------|-----------|----|--------|
| 0331513677 | Ø7.8x13.5 | 35 | 00/006 |
| 0331513676 | Ø8.3x10.2 | 32 | 00/006 |



empilhável
stackable
apilable
empilable



COPO TRIBEKA
tumbler vaso gobelet

| REF | (cm) | CL | |
|------------|----------|----|--------|
| 0331514252 | Ø8.4x12 | 35 | 00/006 |
| 0331514253 | Ø9.3x9.5 | 35 | 00/006 |



COPO
tumbler vaso gobelet

| REF | (cm) | CL | |
|------------|---------|------|--------|
| 0730261014 | Ø8x12 | 41.4 | 01/072 |
| 0732960736 | Ø6.8x10 | 23 | 01/120 |



empilhável
stackable
apilable
empilable



COPO FH
tumbler vaso gobelet

| REF | (cm) | CL | |
|------------|----------|------|--------|
| 0730261010 | Ø7x11.6 | 30 | 00/072 |
| 0730261008 | Ø6.7x10 | 23 | 01/072 |
| 0730261006 | Ø6.5x9.2 | 19 | 01/072 |
| 0730261009 | Ø8.2x8.4 | 27.5 | 00/072 |

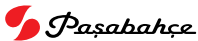

COPO CITY
tumbler vaso gobelet

| REF | (cm) | CL | |
|------------|-----------|----|--------|
| 0331592476 | Ø8.2x13.5 | 36 | 00/012 |
| 0331592516 | Ø8.4x8.7 | 25 | 06/048 |
| 0331592456 | Ø7.6x8 | 19 | 06/048 |



COPO SHETLAND
tumbler vaso gobelet

| REF | (cm) | CL | |
|------------|-----------|----|--------|
| 0331511430 | Ø8.3x13.8 | 35 | 12/048 |
| 0331511433 | Ø7.3x12.3 | 22 | 12/048 |
| 0331519828 | Ø6x7.3 | 9 | 00/006 |
| 0331511431 | Ø9.7x9.7 | 32 | 12/048 |
| 0331511432 | Ø9x8.8 | 25 | 12/048 |



COPO TIN CAN
tumbler vaso gobelet

| REF | (cm) | CL | |
|------------|----------|----|--------|
| 0331590380 | Ø7.6x9.8 | 35 | 06/012 |
| 0331590370 | Ø7.2x8.8 | 28 | 06/012 |



COPO STACK
tumbler vaso gobelet

| REF | (cm) | CL | |
|------------|--------|----|--------|
| 0333750281 | Ø8x8.6 | 25 | 00/012 |





CÁLICES/COPOS

tumblers/glasses vasos/tazas verres/tasses



COPO SYLVANA FH
tumbler vaso gobelet

| REF | (cm) | CL | |
|------------|-----------|------|--------|
| 0331592812 | Ø6.2x14.5 | 38.7 | 03/024 |



COPO BOLERO FH
tumbler vaso gobelet

| REF | (cm) | CL | |
|------------|---------|----|--------|
| 0331592919 | Ø6x14.5 | 32 | 00/012 |



COPO HALICARNASSOS GLASS 4 YOU
tumbler vaso gobelet

| REF | (cm) | CL | |
|------------|-----------|----|--------|
| 0331592449 | Ø6.9x13.9 | 30 | 06/048 |



COPO ISTANBUL
tumbler vaso gobelet

| REF | (cm) | CL | |
|------------|-----------|----|--------|
| 0331592402 | Ø6.2x13.4 | 29 | 00/012 |
| 0331592283 | Ø8.3x8.9 | 30 | 12/048 |
| 0331592405 | Ø7.4x8.8 | 25 | 00/012 |



COPO ROCK-S LONG DRINK
tumbler vaso gobelet

| REF | (cm) | CL | |
|------------|-----------|----|--------|
| 0331594016 | Ø6.5x14.3 | 35 | 06/024 |
| 0331594014 | Ø7.8x8.5 | 29 | 06/024 |



COPO ISLANDE FH
tumbler vaso gobelet

| REF | (cm) | CL | |
|------------|-----------|----|--------|
| 0331511157 | Ø6.4x17 | 36 | 06/048 |
| 0331510067 | Ø6.2x15.7 | 33 | 06/006 |
| 0331510334 | Ø6x16.6 | 31 | 00/012 |
| 0331512372 | Ø6.3x14.5 | 29 | 12/048 |
| 0331510359 | Ø5.8x13 | 22 | 06/048 |
| 0331510367 | Ø5.5x10 | 16 | 06/048 |
| 0331511555 | Ø5x8.7 | 10 | 06/048 |

COPO ISLANDE TUBO
tumbler vaso gobelet

| REF | (cm) | CL | |
|------------|-----------|----|--------|
| 0331511275 | Ø5.3x15.2 | 22 | 00/006 |

COPO ISLANDE FB
tumbler vaso gobelet

| REF | (cm) | CL | |
|------------|----------|----|--------|
| 0331510391 | Ø7.9x9.3 | 30 | 00/006 |
| 0331510383 | Ø7x8.3 | 20 | 06/048 |



COPO TUBO
tumbler vaso gobelet

| REF | (cm) | CL | |
|------------|-----------|----|--------|
| 0331592048 | Ø5.7x16.5 | 33 | 00/024 |
| 0331592178 | Ø5.5x14 | 24 | 12/048 |



COPO GOBELET
tumbler vaso gobelet

| REF | (cm) | CL | |
|------------|---------|----|--------|
| 0331511691 | Ø6x16.5 | 30 | 01/024 |



COPO AIALA
tumbler vaso gobelet

| REF | (cm) | CL | |
|------------|-----------|----|--------|
| 0333750138 | Ø6.3x15.6 | 33 | 00/012 |
| 0333750136 | Ø5.9x16.4 | 31 | 00/012 |
| 0333750139 | Ø6.2x14.3 | 29 | 00/012 |
| 0333750161 | Ø5.3x15 | 22 | 00/012 |
| 0333750156 | Ø7.5x9.2 | 30 | 00/006 |
| 0333750283 | Ø7x8.4 | 20 | 00/012 |
| 0333750742 | Ø5.4x10 | 16 | 00/012 |



COPO TUVITO
tumbler vaso gobelet

| REF | (cm) | CL | |
|------------|---------|----|--------|
| 0333750039 | Ø5.5x15 | 25 | 00/024 |

COPO TUVITO
tumbler vaso gobelet

| REF | (cm) | CL | |
|-------------|---------|-----------|---------|
| 03337500391 | Ø5.5x15 | 25 AF 5 | 00//024 |
| 03337500392 | Ø5.5x15 | 25 AF 3 | 00//024 |



COPO
tumbler vaso gobelet

| REF | (cm) | CL | |
|------------|----------|----|--------|
| 0333474008 | Ø7.3x7.8 | 19 | 06/072 |



COPO
tumbler vaso gobelet

| REF | (cm) | CL | |
|------------|----------|------|--------|
| 0333470008 | Ø7.2x8.5 | 20.6 | 06/072 |



COPO JAMAICA
tumbler vaso gobelet

| REF | (cm) | CL | |
|------------|------|----|--------|
| 0333751852 | Ø8x9 | 28 | 06/036 |



COPO CONIQUE
tumbler vaso gobelet

| REF | (cm) | CL | |
|------------|----------|-------|--------|
| 0331515970 | Ø7x11.4 | 25 ** | 00/006 |
| 0331510295 | Ø7x11.4 | 25 | 00/006 |
| 0331514633 | Ø4.9x7.8 | 8 | 06/192 |

** (fino) resistència extra (thin) extra strength
(fino) resistencia extra (mince) résistance extra



COPO CANA LISA
tumbler vaso gobelet

| REF | (cm) | CL | |
|------------|-----------|----|--------|
| 0331515479 | Ø6.5x10.4 | 20 | 00/012 |





CÁLICES/COPOS

tumblers/glasses vasos/tazas verres/tasses



COPO CONIL
tumbler vaso gobelet

| REF | (cm) | CL | |
|------------|-----------|----|--------|
| 0333750223 | Ø7.6x13.4 | 33 | 00/012 |

1



2



COPO
tumbler vaso gobelet

| REF | (cm) | CL | |
|-------------|-----------|----|--------|
| 03307512381 | Ø6.7x10.5 | 24 | 10/090 |
| 0334030105 | Ø5.9x8.2 | 12 | 00/120 |



PC
COPO
tumbler vaso gobelet

| REF | (cm) | CL | |
|------------|-----------|----|--------|
| 0730261613 | Ø7.4x13.6 | 42 | 12/072 |



COPO FREVO
tumbler vaso gobelet

| REF | (cm) | CL | |
|------------|---------|----|--------|
| 0331497120 | Ø6x11.3 | 22 | 00/024 |



COPO HELLES
tumbler vaso gobelet

| REF | (cm) | CL | |
|------------|-----------|----|--------|
| 0333750748 | Ø6.3x15.2 | 28 | 00/006 |



COPO BARIL
tumbler vaso gobelet

| REF | (cm) | CL | |
|------------|------|----|--------|
| 0331510479 | Ø5x8 | 16 | 00/012 |



NOVO new



COPO BARRILITO
tumbler vaso gobelet

| REF | (cm) | CL | |
|------------|-------|---------|--------|
| 0331013166 | Ø6x12 | 25 AF20 | 00/012 |

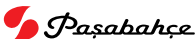

COPO IMPERIAL
tumbler vaso gobelet

| REF | (cm) | CL | |
|------------|-----------|----|--------|
| 0331592376 | Ø5.9x14.5 | 34 | 00/012 |



COPO NONIC
tumbler vaso gobelet

| REF | (cm) | CL | |
|------------|-----------|----|--------|
| 0331511107 | Ø8.7x15.2 | 57 | 00/048 |



COPO MARTIGUES
tumbler vaso gobelet

| REF | (cm) | CL | |
|------------|---------|----|--------|
| 0331510292 | Ø7.9x18 | 33 | 00/006 |



COPO MARTIGUES - VERMUTE - AFERIDO
tumbler vaso gobelet

| REF | (cm) | CL | |
|------------|---------|----|--------|
| 0331518603 | Ø6.9x15 | 16 | 00/012 |



COPO PRINCÍPE
tumbler vaso gobelet

| REF | (cm) | CL | |
|------------|-----------|----------|--------|
| 0331013163 | Ø6.3x17.2 | 25 AF 20 | 00/012 |

NOVO new

Paşabahçe



COPO WEINZENBEER
tumbler vaso gobelet

| REF | (cm) | CL | |
|------------|---------|----|--------|
| 0331592756 | Ø8x23.3 | 50 | 00/006 |

CRISAL



NOVO new



CANECA MAXIM
mug jarra fasse

| REF | (cm) | CL | |
|------------|-------|----|--------|
| 0331012329 | Ø8x16 | 50 | 00/006 |



PACK 2



CANECA CERVEJA
mug jarra fasse

| REF | (cm) | CL | |
|------------|------------------|----|--------|
| 0333474020 | 1 Ø8.8x9.2x14.8 | 55 | 02/024 |
| 0333477223 | 2 Ø9.2x10.3x15.2 | 50 | 02/024 |



CÁLICE TOSCANA
glass copa verre

| REF | (cm) | CL | |
|------------|------------|----|--------|
| 0333750294 | Ø10.8x16.7 | 62 | 00/006 |

Paşabahçe



CÁLICE BISTRO
glass copa verre

| REF | (cm) | CL | |
|------------|-------|----|--------|
| 0331594417 | Ø7x16 | 48 | 06/024 |

CRISAL



NOVO new



CÁLICE MUNIQUE
glass copa verre

| REF | (cm) | CL | |
|------------|-----------|------------|--------|
| 0331013313 | Ø8.5x19.9 | 49 AF 40 | 00/006 |
| 0331013312 | Ø7.9x18 | 37 AF 30 | 00/006 |
| 0331013311 | Ø7x16.4 | 26 AF 20 | 00/006 |

Paşabahçe



CÁLICE CERVEZA
glass copa verre

| REF | (cm) | CL | |
|------------|---------|----|--------|
| 0331597028 | Ø7.9x17 | 38 | 06/024 |
| 0331597019 | Ø7.5x22 | 36 | 06/024 |

Paşabahçe



CÁLICE COCKTAIL CAPRI
glass copa verre

| REF | (cm) | CL | |
|------------|-----------|----|--------|
| 0331594872 | Ø7.4x17.6 | 39 | 00/012 |

Paşabahçe



CÁLICE COCKTAIL HOLIDAY
glass copa verre

| REF | (cm) | CL | |
|------------|-----------|----|--------|
| 0331594403 | Ø8.5x19.6 | 47 | 00/012 |

Arcoroc
Serving solutions



CÁLICE HURRICANE
glass copa verre

| REF | (cm) | CL | |
|------------|-----------|----|--------|
| 0331510770 | Ø7.9x20.8 | 44 | 06/024 |
| 0331514584 | Ø7x19.5 | 25 | 06/024 |



CÁLICE BLUE HAWAII
glass copa verre

| REF | (cm) | CL | |
|------------|-----------|----|--------|
| 0333751065 | Ø8.2x20.7 | 47 | 00/006 |



CÁLICES/COPOS

tumblers/glasses vasos/tazas verres/tasses



mesa table mesa table



COPO HOT SHOT
tumbler vaso gobelet

| REF | (cm) | CL | |
|------------|--------|-----|--------|
| 0331512073 | Ø4.5x7 | 3.4 | 06/024 |



COPO GIN 12
tumbler vaso gobelet

| REF | (cm) | CL | |
|------------|----------|-----|--------|
| 0331511024 | Ø4.2x5.2 | 3.5 | 00/024 |



COPO SHOT BOSTON
tumbler vaso gobelet

| REF | (cm) | CL | |
|------------|--------|----|--------|
| 0331592134 | Ø5x5.9 | 3 | 00/012 |



COPO SIDE
tumbler vaso gobelet

| REF | (cm) | CL | |
|------------|----------|-----|--------|
| 0331592594 | Ø4.6x9.3 | 9.5 | 00/012 |



COPO SHOT ROCKS-S
tumbler vaso gobelet

| REF | (cm) | CL | |
|------------|------|----|--------|
| 0331594013 | Ø4x7 | 6 | 06/024 |

PACK 12

1



2



COPO SHOT
tumbler vaso gobelet

| REF | (cm) | CL | |
|------------|------------|-----|--------|
| 0333471032 | 1 Ø4.7x5.7 | 5.5 | 12/144 |
| 0333470101 | 2 Ø4.1x4.9 | 3 | 12/288 |



COPO SHOT CÓNICO
tumbler vaso gobelet

| REF | (cm) | CL | |
|------------|----------|-----|--------|
| 0333471904 | 1 Ø4x10 | 5.7 | 12/144 |
| 0334031761 | 2 Ø4.5x7 | 4 | 06/024 |



COPO LÚDICO
tumbler vaso gobelet

| REF | (cm) | CL | |
|------------|--------|----|--------|
| 0331519063 | Ø4.2x9 | 6 | 06/048 |



COPO SIDRA MINI
cider tumbler vaso sidra gobelet cider

| REF | (cm) | CL | |
|------------|----------|----|--------|
| 0333750203 | Ø8.2x5.9 | 23 | 00/012 |



COPO GINJA
tumbler vaso gobelet

| REF | (cm) | CL | |
|------------|----------|-----|--------|
| 0333471052 | Ø5.2x6.7 | 6.3 | 01/012 |

PACK 6



CANECA MINI
mug jarra tasse

| REF | (cm) | CL | |
|------------|--------|----|--------|
| 0333470115 | Ø5x7.2 | 8 | 06/144 |

PACK 6



CÁLICE
glass copa verre

| REF | (cm) | CL | |
|------------|----------|-----|--------|
| 0333470009 | Ø2.9x6.3 | 1.5 | 48/288 |



CÁLICE CHARANTE
glass copa verre

| REF | (cm) | CL | |
|------------|-----------|------|--------|
| 0331594835 | Ø7.8x14.9 | 68 | 00/012 |
| 0331594825 | Ø7.8x14.3 | 55 | 12/024 |
| 0331590057 | Ø8x12.6 | 36.5 | 00/012 |



CÁLICE DEGUSTATION WORLS SPIRITS
glass copa verre

| REF | (cm) | CL | |
|------------|----------|----|--------|
| 0331519347 | Ø10.5x15 | 77 | 06/024 |



CÁLICE DEGUSTATION
glass copa verre

| REF | (cm) | CL | |
|------------|-----------|----|--------|
| 0331512664 | Ø9.5x12.9 | 41 | 00/006 |
| 0331512661 | Ø8.2x11.2 | 25 | 00/006 |
| 0331511476 | Ø6.7x9.6 | 15 | 00/012 |
| 0331511507 | Ø6.1x8.4 | 10 | 00/012 |



CÁLICE DEGUSTATION AFERIDO
glass copa verre

| REF | (cm) | CL | |
|------------|-----------|---------|--------|
| 0331510071 | Ø4.5x9 | 10 AF.3 | 00/012 |
| 0331517109 | Ø6.7x9.6 | 15 AF.3 | 00/012 |
| 0331519599 | Ø8.2x11.2 | 25 AF.5 | 00/012 |



CÁLICE COGNAC AFERIDO
glass copa verre

| REF | (cm) | CL | |
|------------|----------|---------|--------|
| 0333750822 | Ø8x11 | 25 AF.5 | 00/006 |
| 0333750820 | Ø6.8x9.8 | 15 AF.3 | 00/012 |



CÁLICE BALLON
glass copa verre

| REF | (cm) | CL | |
|------------|--------|---------|--------|
| 0331632202 | Ø6.5x9 | 15 AF.3 | 12/048 |



JARRO
jug jarro pichet

| REF | (cm) | LT | |
|------------|------|------|--------|
| 0331590102 | 20 | 1 | 00/006 |
| 0331590101 | 15.3 | 0.5 | 00/006 |
| 0331590100 | 12.3 | 0.25 | 00/006 |



JARRO TIVOLI
jug jarro pichet

| REF | (cm) | LT | |
|------------|------|-----|--------|
| 0331512121 | 20 | 1.6 | 01/006 |



JARRO
jug jarro pichet

| REF | (cm) | LT | |
|------------|------|-----|--------|
| 0333473006 | 20 | 1.4 | 01/024 |



JARRO
jug jarro pichet

| REF | (cm) | LT | |
|------------|------|------|--------|
| 0331593434 | 23.6 | 1.25 | 01/006 |



JARRO NIAGARA
jug jarro pichet

| REF | (cm) | LT | |
|------------|------|-----|--------|
| 0331593864 | 25 | 2.5 | 01/006 |



JARRO
jug jarro pichet

| REF | (cm) | LT | |
|------------|------|------|--------|
| 0333473001 | 21.5 | 1.25 | 01/012 |



JARRO
jug jarro pichet

| REF | (cm) | LT | |
|------------|------|-----|--------|
| 0331513061 | 24 | 1.6 | 00/006 |
| 0331513062 | 21.5 | 1.3 | 00/006 |
| 0331516358 | 20 | 1 | 00/006 |
| 0331516341 | 14.5 | 0.5 | 00/012 |



JARRO C/TAMPA BUCOLIQUE
jug with lid jarro con tapa pichet avec couvercle

| REF | (cm) | LT | |
|------------|------|-----|--------|
| 0331517131 | 21.5 | 1.3 | 01/001 |



JARRO C/TAMPA BISTRO
jug with lid jarro con tapa pichet avec couvercle

| REF | (cm) | LT | |
|------------|------|-----|--------|
| 0331593934 | 26 | 1.8 | 00/006 |



JARRO C/TAMPA
jug with lid jarro con tapa pichet avec couvercle

| REF | (cm) | LT | |
|-------------|------|------|--------|
| 03334730011 | 21.5 | 1.25 | 01/012 |



JARRO C/TAMPA BISTRO
jug with lid jarro con tapa pichet avec couvercle

| REF | (cm) | LT | |
|------------|------|----|--------|
| 0331590119 | 24 | 2 | 00/006 |



JARRO PICHET
jug jarro pichet

| REF | (cm) | LT | |
|------------|------|-----|--------|
| 0331512126 | 20 | 1.3 | 00/006 |



JARRO C/TAMPA BASIC
jug with lid jarro con tapa pichet avec couvercle

| REF | (cm) | LT | |
|------------|------|------|--------|
| 0331593884 | 27.5 | 1.25 | 01/012 |





CÁLICES/COPOS

tumblers/glasses vasos/tazas verres/tasses



NOVO
new



GARRAFA ENSEMBLE
decanter botella carafe

| REF | (cm) | LT | |
|------------|-----------|------|--------|
| 0331015774 | Ø8.5x24.2 | 0.5 | 00/006 |
| 0331015733 | Ø7x17 | 0.25 | 00/006 |



GARRAFA VILLAGE
decanter botella carafe

| REF | (cm) | LT | |
|------------|-----------|----------------|--------|
| 0331593824 | Ø9.4x24.9 | 1.25 AF 1 | 01/006 |
| 0331593814 | Ø8x20 | 0.7 AF 0.5 | 01/006 |
| 0331593804 | Ø6x17 | 0.36 AF 0.25 | 01/012 |



GARRAFA VIN
decanter botella carafe

| REF | (cm) | LT | |
|------------|----------|------|--------|
| 0331510291 | Ø10.5x20 | 1 | 00/012 |
| 0331513040 | Ø9x16 | 0.5 | 00/012 |
| 0331514436 | Ø7.5x13 | 0.25 | 00/012 |



GARRAFA
decanter botella carafe

| REF | (cm) | LT | |
|-------------|---------|-----|--------|
| 03324450961 | Ø9.5x20 | 0.5 | 00/024 |
| 0332445096 | Ø9.5x27 | 1 | 00/012 |



GARRAFA BACCHUS
decanter botella carafe

| REF | (cm) | LT | |
|------------|----------|------|--------|
| 0331590111 | Ø10.5x26 | 1 | 00/012 |
| 0331590113 | Ø8.5x21 | 0.5 | 00/006 |
| 0331590112 | Ø7x17.5 | 0.25 | 00/006 |



DECANTER CARAFE CELEBRATION
decanter decanter decanteur

| REF | (cm) | LT | |
|------------|------|----|--------|
| 0331593634 | 27 | 2 | 01/006 |



GARRAFA ELEGANCE
decanter botella carafe

| REF | (cm) | LT | |
|------------|--------|----|--------|
| 0331517972 | Ø11x30 | 1 | 01/006 |



UTENSÍLIOS DE SERVIR

serving utensils utensilios para servir ustensiles de service



UTENSÍLIOS DE SERVIR

servicing utensils utensilios para servir ustensils de service

mesa table mesa table



INOX **PACK 6**

GARFO MARISCO

seafood fork tenedor marsicos fourchette à crustacés

| REF | (cm) | |
|------------|------|--------|
| 0433940024 | 20.5 | 01/500 |

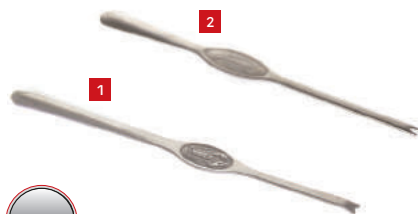

INOX

GARFO MARISCO

seafood fork tenedor marsicos fourchette à crustacés

| REF | (cm) | |
|---------------------|------|--------|
| 0433870047 1 | 19 | 01/500 |
| 0430721051 2 | 20 | 12/600 |



INOX

COLHER P/MEL

spoon for honey cuchara para mel cuillère pour miel

| REF | (cm) | |
|------------|------|--------|
| 0433870140 | 20 | 01/030 |



INOX

COPO SERVIR

cup vaso tasse

| REF | (cm) | |
|----------------------|----------|--------|
| 04312600853 1 | Ø8.5x8.5 | 01/072 |
| 0433651458 2 | Ø8.5x8.5 | 10/050 |
| 04312600852 3 | Ø8.5x8.5 | 12/048 |
| 04312600151 4 | Ø8.5x12 | 12/060 |



INOX

COPO SERVIR

cup vaso tasse

revestimento em cobre
copper coating
recubrimiento de cobre
revêtement de cuivre

| REF | (cm) | |
|---------------------|----------|--------|
| 0432790052 1 | Ø8.5x8.5 | 02/120 |
| 0433654950 2 | Ø8.5x8.5 | 01/010 |



INOX

BALDE SERVIR

bucket balde seau

| REF | (cm) | |
|----------------------|----------|--------|
| 0433651536 1 | Ø9x10 | 01/060 |
| 04312600951 2 | Ø9.5x9.5 | 12/072 |
| 0433651536 | Ø9x10 | 01/100 |
| 04312600097 3 | Ø9x9 | 12/072 |
| 0433652109 4 | Ø9.5x10 | 01/100 |



INOX

BALDE SERVIR

bucket balde seau

inox galvanizado
galvanized stainless steel
acero inoxidable galvanizado
acier inoxydable galvanisé

| REF | (cm) | CL | |
|-------------|--------|----|--------|
| 04312600083 | Ø8x8 | 25 | 01/200 |
| 0431269010 | Ø10x10 | 50 | 01/144 |



INOX

CAÇAROLA SERVIR
casserole cacerola cocotte



| REF | (cm) | |
|------------|--------------|--------|
| 0433658915 | 14.5x9.5x4.5 | 06/024 |



INOX

MINI FRIGIDEIRA
mini fryer mini freidor mini friteuse

| REF | (cm) | |
|-------------|---------|--------|
| 04312690125 | Ø12x3.5 | 01/036 |



INOX

MINI FRIGIDEIRA
mini fryer mini freidor mini friteuse

revestimento em cobre
copper coating
recubrimiento de cobre
revêtement de cuivre

| REF | (cm) | LT | |
|------------|-----------|-----|--------|
| 0431260115 | Ø11.5x3.5 | 1.3 | 01/120 |



1

2

INOX

CAÇAROLETE
casserole cacerolita cocotte

| REF | (cm) | |
|-------------|----------|--------|
| 04327900091 | 1 09x6.1 | 07/072 |
| 0432790009 | 2 09x6.1 | 07/072 |



INOX

CAÇAROLA MINI C/TAMPA
mini casserole cacerola mini cocotte mini

| REF | (cm) | |
|------------|-----------|--------|
| 0432790102 | Ø10.2x7.5 | 07/072 |



INOX

CESTO SERVIR
basquet freidora panier

| REF | (cm) | |
|------------|---------|--------|
| 0430729010 | Ø9x10.5 | 12/048 |

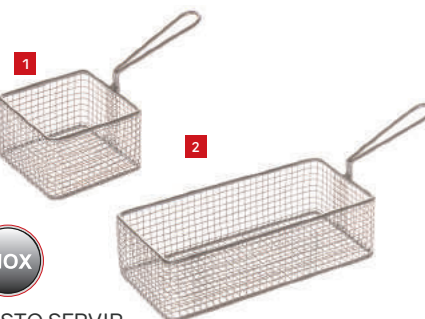

1

2

INOX

CESTO SERVIR
basquet freidora panier

| REF | (cm) | |
|------------|-----------|--------|
| 0430721010 | 9.5x9.5x6 | 12/048 |
| 0430722111 | 21x10x6 | 12/036 |



INOX

CESTO SERVIR
basquet freidora panier

| REF | (cm) | |
|------------|-------|--------|
| 0431261411 | 14x11 | 01/024 |



INOX

ESCORREDOR SERVIR
colander escurridera passoire

| REF | (cm) | |
|------------|----------|--------|
| 0431260130 | Ø9.7x5.5 | 01/072 |



INOX

SUPORTE P/CONES
cones support soporte para cono support pour cône

| REF | (cm) | |
|------------|-------|--------|
| 0431261420 | 14x20 | 12/048 |



UTENSÍLIOS DE SERVIR

serving utensils utensilios para servir ustensiles de service

mesa table mesa table



WENGUÉ

INOX

PORCELANA
PORCELAIN
PORCELAINA
PORCELAINA

SUPORTE P/ESPETADA C/PRATO
skewer stand with plate
soporte pinchos con plato
support brochette avec assiette

| REF | (cm) | |
|------------|------|--------|
| 0438670038 | - | 01/001 |

suporte support apoyo support 20x20x46.5
taça bol taza tasse Ø18

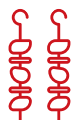

WENGUÉ

INOX

PORCELANA
PORCELAIN
PORCELAINA
PORCELAINA

SUPORTE P/ESPETADA C/TRAVESSA
skewer stand with tray
soporte pinchos con fuente
support brochette avec plat

| REF | (cm) | |
|------------|------|--------|
| 0438670023 | - | 01/001 |

suporte support apoyo support 29x19.5x45
taça bol taza tasse 23x15.7



WENGUÉ

INOX

PORCELANA
PORCELAIN
PORCELAINA
PORCELAINA

SUPORTE P/ESPETADA C/PRATO
skewer stand with plate
soporte pinchos con plato
support brochette avec assiette

| REF | (cm) | |
|------------|------|--------|
| 0438670464 | - | 01/001 |

suporte support apoyo support 24x20x45
taça bol taza tasse 22x17

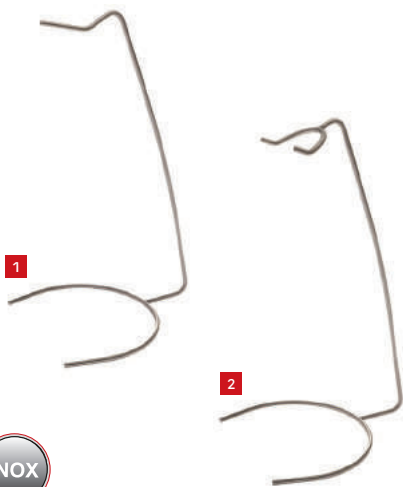

INOX

SUPORTE P/ESPETADA
skewer stand soporte pinchos support brochette

| REF | (cm) | |
|------------|------------|--------|
| 0439080000 | 1 28x24x47 | 01/001 |
| 0439080001 | 2 28x24x47 | 01/001 |

INOX

PACK
12

ESPETOS C/FLOR DE LIS
skewer set conjunto pinchos set brochette

| REF | (cm) | |
|-------------|------|--------|
| 04312600019 | 25 | 12/300 |



INOX

PACK
12

ESPETOS C/ESPADÁ
skewer set conjunto pinchos set brochette

| REF | (cm) | |
|-------------|------|--------|
| 04312600057 | 25 | 12/300 |



espetos esalmados
flat skewers
pinchos aplanados
brochettes évasées



INOX **PACK 12**

ESPETOS C/ARGOLA
skewer set conjunto pinchos set brochette

| REF | (cm) | |
|------------|------|----------------------|
| 0433655230 | 30 | 01/100 |
| 0433655235 | 35 | 01/100 |
| 0433655240 | 40 | PACK 6 01/100 |



INOX

GANCHOS
hooks ganchos crochets

| REF | (cm) | |
|------------|------|--------|
| 0433657514 | 14 | 01/126 |



INOX

GANCHOS DUPLOS
hooks ganchos crochets

| REF | (cm) | |
|------------|------|--------|
| 0430688902 | 32 | 10/180 |



INOX

PRATO RASO
dinner plate plato llano assiette plate

| REF | (cm) | |
|------------|------|--------|
| 0433651571 | Ø24 | 01/050 |



INOX

PRATO SOPA
soup plate plato hondo assiette creuse

| REF | (cm) | |
|------------|------|--------|
| 0433651572 | Ø24 | 01/050 |



INOX

MARMITA
lunch box fiabrera boîte alimentaire

| REF | (cm) | LT | |
|------------|---------|----|--------|
| 0433655518 | Ø18x7.5 | 2 | 01/020 |



INOX

FONDUE
fondue fondue fondue

| REF | (cm) | LT | |
|------------|--------|----|--------|
| 0430686001 | Ø14x15 | 35 | 01/024 |



FERRO FUNDIDO
CAST IRON
HIERRO FUNDIDO
FER FONDU

FONDUE
fondue fondue fondue

| REF | (cm) | LT | |
|------------|--------|-----|--------|
| 0433692217 | Ø17x10 | 1.5 | 01/004 |

INTERIOR ESMALTADO ENAMELED INTERIOR
INTERIOR ESMALTADO INTÉRIEUR ÉMAILLÉ

PORCELANA
PORCELAIN
PORCELANA
PORCELAINE



FONDUE CHOCOLATE 7 PEÇAS
chocolat fondue fondue chocolate fondue chocolat

| REF | (cm) | CL | |
|------------|------------|----|--------|
| 0230760581 | 28x16.8x15 | 30 | 01/008 |

A receita ideal para os dias frios!
Combinação perfeita
com fruta fresca e biscoitos...

The ideal recipe for the cold days
Perfect combination with fresh fruit and biscuits ...

La receta ideal para los días fríos!
Combinación perfecta con fruta fresca y galletas ...

La recette idéale pour les jours froids
Match parfait avec des fruits frais et des biscuits ...





UTENSÍLIOS DE SERVIR

serving utensils utensilios para servir ustensiles de service



CONJUNTO BIFE NA PEDRA

set steak in stone
conjunto de carne en piedra
ensemble steak dans la pierre

| REF | (cm) | |
|------------|------|--------|
| 0438140007 | * | 01/001 |
| 0438140006 | ** | 01/001 |

* base de madeira wood base base de madera base en bois 28.5x23x3
pedra rock piedra pierre 17x17x3
taças vidro glass bowls tazas vidrio tasses verré Ø6x2.5 (3x)

** base de madeira wood base base de madera base en bois 34x27x3
pedra stone piedra pierre 21x21x3
taças vidro glass bowls tazas vidrio tasses verré Ø6x2.5 (3x)



CONJUNTO BIFE NA PEDRA

set steak in stone
conjunto de carne en piedra
ensemble steak dans la pierre

| REF | (cm) | |
|------------|------|--------|
| 0933642501 | * | 01/002 |

base de madeira wood base base de madera base en bois 32x27.5x1.5
pedra vulcânica volcanic stone pedra volcânica pierre volcanique 20x15x3
faça porcelana porcelain bowl taza de porcelana tasse de porcelaine Ø7.2x3.8 (3x)
base inox stainless steel base base de acero inoxidable base en acier inoxydable 24.2x19.2x1.5



CONJUNTO BIFE NA PEDRA

set steak in stone
conjunto de carne en piedra
ensemble steak dans la pierre

| REF | (cm) | |
|------------|------|--------|
| 0933641425 | * | 01/002 |

base de madeira wood base base de madera base en bois 38x27.2x1.8
pedra vulcânica volcanic stone pedra volcânica pierre volcanique 20x15x3
faça porcelana porcelain bowl taza de porcelana tasse de porcelaine Ø7x4.5 (3x)
travessa porcelana porcelain platter fuente de porcelana plateau de porcelaine 24.5x10x3
base inox stainless steel base base de acero inoxidable base en acier inoxydable 24.2x19.2x1.5



MOINHO PIMENTA/SAL

pepper/salt grinder molinillo pimienta/sal moulin poivre/sel

| REF | (cm) | |
|------------|-------------|--------|
| 0732761990 | 1 Ø5.7x18.3 | 00/036 |
| 0732761991 | Ø5.7x21 | 00/036 |
| 0732760112 | 2 Ø6.2x31.5 | 00/024 |
| 0732761962 | 3 Ø5.1x16.3 | 00/048 |



MOINHO PIMENTA/SAL

pepper/salt grinder molinillo pimienta/sal moulin poivre/sel

| REF | (cm) | |
|------------|-----------|--------|
| 0732760060 | Ø5.5x15.5 | 00/048 |



MOINHO PIMENTA

pepper grinder molinillo pimienta moulin poivre

| REF | (cm) | |
|------------|-----------|--------|
| 0432270709 | 1 04.2x7 | 24/096 |
| 0432270800 | 2 05.7x16 | 00/024 |



MOINHO PIMENTA

pepper grinder molinillo pimienta moulin poivre

| REF | (cm) | |
|-------------|---------|--------|
| 04307510221 | 04.5x15 | 01/048 |



MOINHO PIMENTA

pepper grinder molinillo pimienta moulin poivre

| REF | (cm) | |
|------------|---------|--------|
| 0430752410 | 02.5x15 | 00/050 |



CONJUNTO SALEIRO/PIMENTEIRO

salt / pepper set conjunto salero / pimienta ensemble salière poivrière

| REF | (cm) | |
|-------------|---------------|--------|
| 04312600055 | 1 04.5x6 (2x) | 01/200 |
| 0432430001 | 2 04x5.5 (2x) | 00/072 |



CONJUNTO SALEIRO/PIMENTEIRO

salt / pepper set conjunto salero / pimienta ensemble salière poivrière

| REF | (cm) | |
|------------|------------|--------|
| 0431260015 | 04x10 (2x) | 01/200 |



CONJUNTO SALEIRO/PIMENTEIRO

salt / pepper set conjunto salero / pimienta ensemble salière poivrière

| REF | (cm) | |
|------------|------|--------|
| 0430754154 | - | 30/060 |

suporte support apoyo support 11x5.5x13.4
saleiro/pimenteiro salt / pepper salero / pimentero
salière / poivrière 04.3x6.5 (2x)



CONJUNTO SALEIRO/PIMENTEIRO

salt / pepper set conjunto salero / pimienta ensemble salière poivrière

| REF | (cm) | |
|------------|------|--------|
| 0430682301 | - | 01/024 |

suporte support apoyo support 7.8x3.7x13
saleiro/pimenteiro salt / pepper salero / pimentero
salière / poivrière 03x9 (2x)



SALEIRO

salt salero salière

| REF | (cm) | |
|-------------|----------|--------|
| 02304643801 | 04.6x8.5 | 01/024 |



PIMENTEIRO

pepper pimienta poivrière

| REF | (cm) | |
|-------------|----------|--------|
| 02304643802 | 04.6x8.5 | 01/024 |



SALEIRO/PIMENTEIRO

salt / pepper salero / pimienta salière poivrière

| REF | (cm) | |
|------------|-----------|--------|
| 0230760546 | 05x6 (2x) | 01/072 |



SALEIRO/PIMENTEIRO

salt / pepper salero / pimienta salière poivrière

| REF | (cm) | |
|-------------|------------|--------|
| 0332441104 | 1 03.3x9.5 | 01/144 |
| 0332445814 | 2 5x5x8.5 | 01/144 |
| 0332445065 | 3 04x7.2 | 00/006 |
| 03315900301 | 4 04.6x8.5 | 02/048 |





UTENSÍLIOS DE SERVIR

servicing utensils utensilios para servir ustensiles de service



SALEIRO

salt shaker salero salière

| REF | (cm) | |
|------------|-----------|--------|
| 0732963100 | Ø5.5x10.8 | 01/012 |



PIMENTEIRO

pepper shaker pimentero poivrière

| REF | (cm) | |
|------------|-----------|--------|
| 0732963101 | Ø5.5x10.8 | 01/012 |



PORTA ESPECIARIAS

spices shaker especiero saupoudreuse

| REF | (cm) | |
|------------|-----------|--------|
| 0732963102 | Ø5.5x10.8 | 01/012 |



GALHETA

oil/vinager aceitera/vinagrera huile/vinaigries

| REF | (cm) | ML | |
|------------|---------|-----|--------|
| 0732963103 | Ø6.2x17 | 180 | 01/012 |



GALHETA

oil can aceitera huile

| REF | (cm) | CL | |
|------------|-----------|----|--------|
| 0433656935 | Ø6.7x24.5 | 50 | 01/048 |



CONJUNTO GALHETEIRO 2 PEÇAS

cruet set 2 pcs
conjunto vinagrera 2 piezas
set huile/vinaigre 2 pièces

| REF | (cm) | CL | |
|-------------|------|----|--------|
| 04322517882 | - | 18 | 01/024 |

suporte support apoyo support 11x5.3x21.5

galhetas oil/vinager aceitera/vinagrera huile/vinaigries Ø4.7x20 (2x)



GALHETA

oil can aceitera huile

| REF | (cm) | CL | |
|------------|-----------|----|--------|
| 0432430350 | Ø7.2x21.5 | 35 | 01/052 |



CONJUNTO GALHETEIRO

cruet set conjunto vinagrera set huile/vinaigre

| REF | (cm) | CL | |
|------------|------|----|--------|
| 0433660018 | 1 | 18 | 01/024 |
| 0433660015 | 2 | 18 | 01/024 |

GALHETA

oil/vinager aceitera/vinagrera huile/vinaigries

| REF | (cm) | CL | |
|------------|------|---------|-----------|
| 0430751103 | 3 | Ø4.7x16 | 18 00/072 |

suporte support apoyo support 11x10.5x21.5 1 2

galhetas oil/vinager aceitera/vinagrera huile/vinaigries Ø4.7x16 (2x) 1 2

saleiro/pimenteiro salt/pepper salero/pimentero salière/poivrière Ø3.3x9.5 (2x) 2



GALHETA OLIVIA
oil can aceitera huile

| REF | (cm) | CL | |
|------------|-------|----|--------|
| 0331590108 | Ø9x17 | 26 | 01/012 |



ALMOTOLIA
oil can aceitera huile

| REF | (cm) | LT | |
|-------------|----------|----|--------|
| 04314726041 | Ø11.5x28 | 1 | 01/024 |



GALHETA
oil can aceitera huile

| REF | (cm) | CL | |
|------------|-------|----|--------|
| 0210214815 | Ø6x18 | 20 | 01/072 |
| 0210214820 | Ø7x23 | 30 | 01/036 |



AZEITONEIRA
oil dish aceitunera plat à olive

| REF | (cm) | |
|------------|------|--------|
| 0433654613 | 13x6 | 01/200 |
| 0433654617 | 17x8 | 01/200 |



AZEITONEIRA
oil dish aceitunera plat à olive

| REF | (cm) | |
|------------|------|--------|
| 0433655548 | 15x7 | 01/200 |



MOLHEIRA
sauce boat salsera saucière

| REF | (cm) | CL | |
|------------|--------|----|--------|
| 0433653110 | Ø6.2x6 | 15 | 01/060 |



MOLHEIRA
sauce boat salsera saucière

| REF | (cm) | CL | |
|------------|------------|----|--------|
| 0433981347 | 17x7.8x9 | 15 | 12/144 |
| 0430685307 | 21x9.5x10 | 24 | 01/100 |
| 0433653130 | - | 24 | 01/001 |
| 0434070124 | 19x7.3x7.4 | 15 | 01/100 |



MOLHEIRA BASIC
sauce boat salsera saucière

| REF | (cm) | CL | |
|------------|--------------|----|--------|
| 0331595012 | 14.5x6.8x9.5 | 17 | 00/012 |
| 0331595002 | 9.5x5x6.5 | 6 | 00/012 |



MOLHEIRA BASIC
sauce boat salsera saucière

| REF | (cm) | CL | |
|------------|--------|----|--------|
| 0331595042 | Ø7.5x9 | 20 | 00/012 |



MOLHEIRA C/PRATO
sauce boat with plate salsera con plato saucière avec assiette

| REF | (cm) | CL | |
|------------|----------|----|--------|
| 0220254162 | 21x11x10 | 40 | 01/018 |



MANTEIGUEIRA
butter dish mantequera beurrier

| REF | (cm) | |
|------------|------|--------|
| 0230760404 | Ø8x6 | 06/072 |



UTENSÍLIOS DE SERVIR

serving utensils utensilios para servir ustensiles de service



INOX

SUPORTE P/OVOS
egg holder porta huevos coquetier

| REF | (cm) | |
|-------------|---------|--------|
| 04312690061 | 10x10x2 | 01/300 |

NOVO
new



PORCELANA
PORCELAIN
PORCELANA
PORCELAINÉ

PORTA OVOS
egg holder porta huevos coquetier

| REF | (cm) | |
|------------|----------|--------|
| 0231420052 | Ø5.1x6.3 | 01/144 |

NOVO
new



PORCELANA
PORCELAIN
PORCELANA
PORCELAINÉ

PORTA OVOS
egg holder porta huevos coquetier

| REF | (cm) | |
|------------|------|--------|
| 0234110091 | Ø5x4 | 12/240 |



INOX

CLOCHE P/PRATOS
plate cover cubreplatos cloches

| REF | (cm) | |
|-------------|---------|--------|
| 04306803041 | Ø24x8.5 | 05/030 |

INOX



CLOCHE P/PRATOS
plate cover cubreplatos cloches

| REF | (cm) | |
|------------|-------|--------|
| 0430688715 | Ø26.5 | 01/100 |

PC



CLOCHE P/PRATOS
plate cover cubreplatos cloches

| REF | (cm) | |
|-------------|-------|--------|
| 07302600102 | Ø26.3 | 00/036 |



INOX

TRAVESSA PEIXE
fish tray fuente pescado plateau à poisson

| REF | (cm) | |
|-------------|------|--------|
| 04336512311 | 65 | 02/010 |
| 0433651231 | 55 | 01/020 |



INOX

TRAVESSA OVAL
oval tray fuente oval plateau ovale

| REF | (cm) | |
|-------------|-------|--------------------|
| 04324300601 | 60x37 | 01/030 |
| 0432430055 | 55x35 | 01/030 |
| 04324300501 | 50x32 | 01/030 |
| 0432430045 | 45x30 | 01/030 |
| 0433656440 | 40x27 | NOVO new 01/001 |
| 0432430040 | 40x27 | 00/024 |
| 04324300352 | 35x22 | 00/036 |
| 04324300302 | 30x20 | 00/036 |
| 0432430025 | 25x19 | 00/048 |
| 04324300201 | 20x17 | 00/048 |



INOX

TRAVESSA MODELO ITALIANO
tray fuente plateau

| REF | (cm) | |
|-------------|------|--------|
| 04336501273 | 40 | 01/025 |
| 04336501272 | 35 | 01/025 |
| 04336501271 | 30 | 01/050 |
| 0433650127 | 25 | 01/050 |



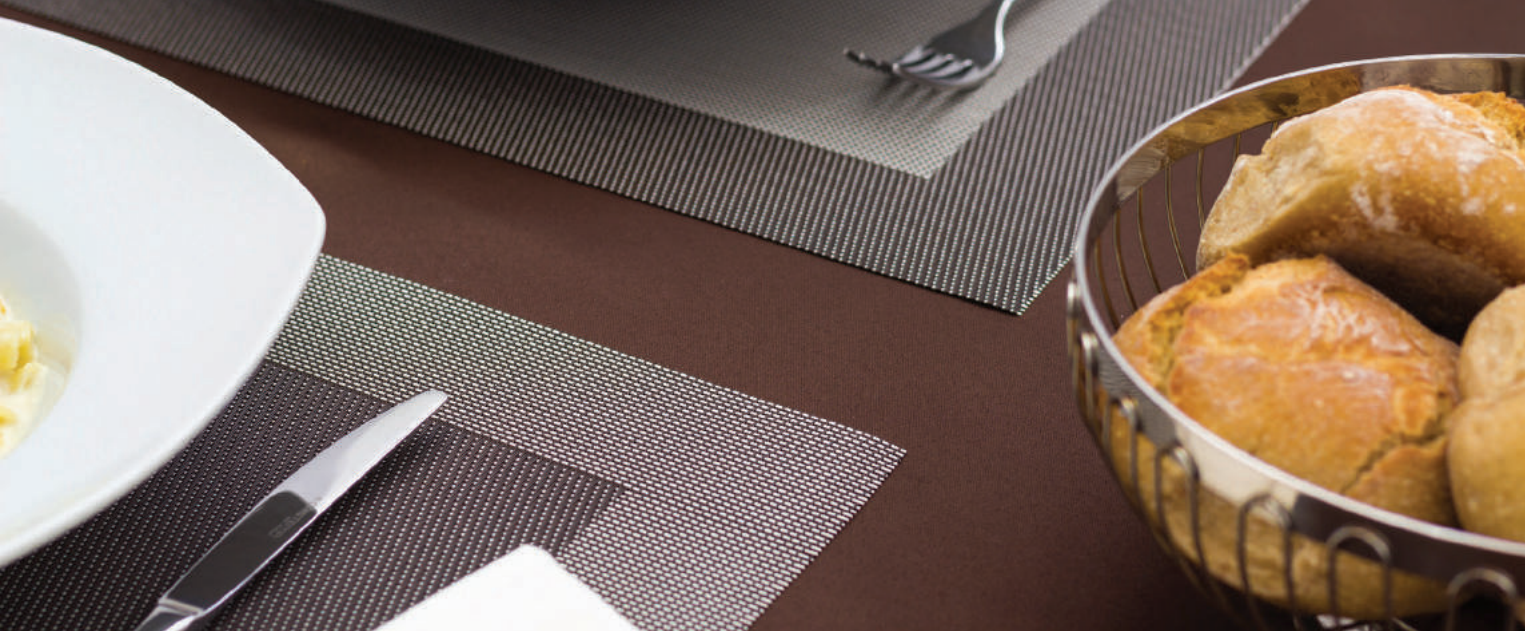

TOALHETE INDIVIDUAL
individual wipe mantel individual nappe individuel

| REF | (cm) | | |
|------------|-------|--|--------|
| 0934020010 | 45x30 | | 06/144 |
| 0934020011 | 45x30 | | 06/144 |
| 0934020012 | 45x30 | | 06/144 |

imitação madeira
wood imitate
imitación madera
imitation du bois

TOALHETE INDIVIDUAL
individual wipe mantel individual nappe individuel

| REF | (cm) | | |
|------------|-------|--|--------|
| 0934020221 | 45x30 | | 06/120 |
| 0934021001 | 45x30 | | 06/120 |
| 0934021012 | 45x30 | | 06/120 |
| 0934021013 | 45x30 | | 06/120 |

TOALHETE INDIVIDUAL
individual wipe mantel individual nappe individuel

| REF | (cm) | | |
|------------|-------|--|--------|
| 0934020387 | 45x30 | | 06/120 |
| 0934020389 | 45x30 | | 06/120 |

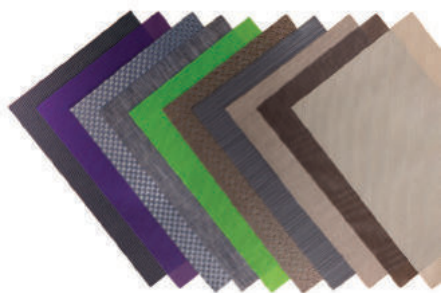

PVC

TOALHETE INDIVIDUAL
individual wipe mantel individual nappe individuel

| REF | (cm) | | |
|------------|-------|--|--------|
| 0932985526 | 45x30 | | 06/120 |
| 0932985459 | 45x30 | | 06/120 |
| 0932981083 | 45x30 | | 06/120 |
| 0932985324 | 45x30 | | 06/120 |
| 0932985522 | 45x30 | | 06/120 |
| 0932989024 | 45x30 | | 06/120 |
| 0932981375 | 45x30 | | 06/120 |
| 0932980254 | 45x30 | | 06/120 |

METAL

EXPOSITOR P/TOALHETES INDIVIDUAIS
stand expositor exposant

| REF | (cm) | |
|------------|-------------|--------|
| 0934020001 | 52x53x172.7 | 01/001 |







buffet buffet buffet buffet



Buffet

buffet buffet buffet

191



APRESENTAÇÃO

presentation presentación présentation

227



CHAFING DISH

chafing dish chafing dish chafing dish

234



TRANSPORTE/ARMAZENAMENTO

transport/storage transporte/almacenamiento transport/stockage

251



MENU/APRESENTAÇÃO

menu/presentation menú décoration





APRESENTAÇÃO
presentation presentación présentation



APRESENTAÇÃO

presentation presentación presentación



PLACA ARDÓSIA

slate tray fuente pizarra plateau ardoise

| REF | (cm) | |
|------------|-----------|----------------------|
| 0932534530 | 45x30 | 01/006 |
| 0932535332 | 53x32.5 | 01/004 |
| 0933643226 | 32.5x26.5 | GN 1/2 01/010 |
| 0933643020 | 30x20 | 01/010 |
| 0933642525 | 25x25 | 01/010 |
| 0933642020 | 20x20 | 01/010 |
| 0933641515 | 15x15 | 01/010 |



TÁBUA P/APRESENTAÇÃO

display plate soporte presentación présentoir

| REF | (cm) | |
|------------|-----------|--------|
| 0233917507 | 28.3x18.3 | 01/024 |



TÁBUA P/APRESENTAÇÃO

display plate soporte presentación présentoir

| REF | (cm) | |
|------------|-----------|--------|
| 0233917510 | 41.5x12.5 | 01/012 |



PLACA P/APRESENTAÇÃO

display plate soporte presentación présentoir

| REF | (cm) | |
|------------|-----------|--------|
| 0233912223 | 28.8x11x1 | 01/012 |



PLACA P/APRESENTAÇÃO

display plate soporte presentación présentoir

| REF | (cm) | |
|-------------|---------------|--------|
| 02339172311 | 37.2x25.8x1.5 | 01/024 |
| 0233917231 | 29.7x23.5x1.5 | 01/018 |



TÁBUA P/APRESENTAÇÃO

display plate soporte presentación présentoir

| REF | (cm) | |
|------------|-------------|--------|
| 0233917233 | 37.2x18x1.7 | 01/012 |



PLACA P/APRESENTAÇÃO

display plate soporte presentación présentoir

| REF | (cm) | |
|------------|-------------|--------|
| 0233917235 | 31.5x23x1.7 | 01/012 |



imitação madeira
wood imitate
imitación madera
imitation du bois



PLACA P/APRESENTAÇÃO
display plate soporte presentación présetoir

| REF | (cm) | | |
|-------------|---------------|--------|--------|
| 07325600115 | 53x26x0.8 | GN 1/1 | 05/010 |
| 07325600129 | 32x26x0.8 | GN 1/2 | 06/012 |
| 07325600134 | 32.5x17.5x0.8 | GN 1/3 | 06/024 |
| 0732560014 | 30x30x0.6 | GN 1/4 | 06/012 |

imitação madeira
wood imitate
imitación madera
imitation du bois



TÁBUA P/APRESENTAÇÃO
display plate soporte presentación présetoir

| REF | (cm) | |
|-------------|-----------|--------|
| 07325648191 | 45x17.5x1 | 12/024 |

imitação de ardósia
slate imitation
imitación pizarra
imitation ardoise



PLACA P/APRESENTAÇÃO
display plate soporte presentación présetoir

| REF | (cm) | | |
|-------------|-------|--------|--------|
| 07325600125 | 32x26 | GN 1/2 | 03/012 |
| 07325600132 | 32x17 | GN 1/3 | 06/024 |
| 07325600126 | 30x20 | | 06/012 |

imitação de ardósia
slate imitation
imitación pizarra
imitation ardoise



PLACA P/APRESENTAÇÃO
display plate soporte presentación présetoir

| REF | (cm) | | |
|-------------|---------|--------------------|--------|
| 0732562512 | 30x15x2 | NOVO new | 06/042 |
| 07325600128 | 32x26 | GN 1/2 | 06/012 |
| 07325600133 | 32x17 | GN 1/3 | 06/012 |

imitação de ardósia
slate imitation
imitación pizarra
imitation ardoise



TÁBUA P/APRESENTAÇÃO
display plate soporte presentación présetoir

| REF | (cm) | |
|------------|-----------|--------|
| 0732564819 | 45x17.5x1 | 05/020 |



PLACA P/APRESENTAÇÃO
display plate soporte presentación présetoir

| REF | (cm) | |
|------------|---------------|--------|
| 0732568002 | 35.5x16.5x1.8 | 06/024 |



PLACA EXPOSITORA
display plate soporte presentación présetoir

| REF | (cm) | | |
|-------------|-----------|---|--------|
| 0732562121 | 54.5x33x2 | □ | 04/008 |
| 07325621211 | 54.5x33x2 | ■ | 04/008 |
| 0732562118 | 46x23x2 | □ | 04/008 |
| 07325621182 | 46x23x2 | ■ | 04/008 |



PLACA EXPOSITORA
display plate soporte presentación présetoir

| REF | (cm) | | |
|-------------|---------|---|--------|
| 07325621181 | 46x23x2 | □ | 04/012 |
| 07325621183 | 46x23x2 | ■ | 04/012 |

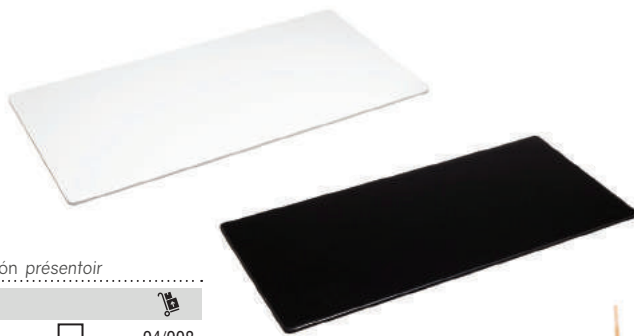

PRATO REDONDO
plate plato assiette

| REF | (cm) | | |
|------------|-------|---|--------|
| 0732562014 | Ø35.2 | □ | 09/018 |
| 0732562012 | Ø30.5 | □ | 12/024 |
| 0732562016 | Ø40.5 | ■ | 06/018 |



APRESENTAÇÃO

presentation presentación presentación

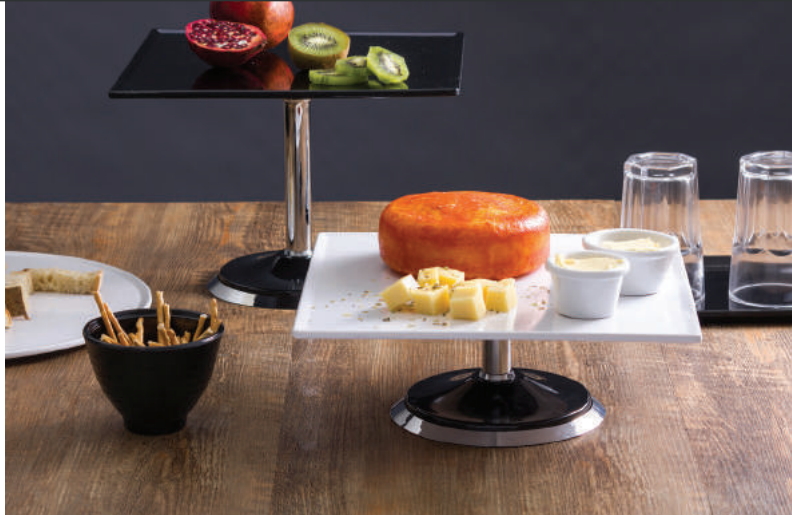

buffet buffet buffet buffet



PRATO REDONDO

plate plato assiette

| REF | (cm) | | |
|------------|-------|--------------------------|--------|
| 0730832046 | Ø32.5 | <input type="checkbox"/> | 01/006 |

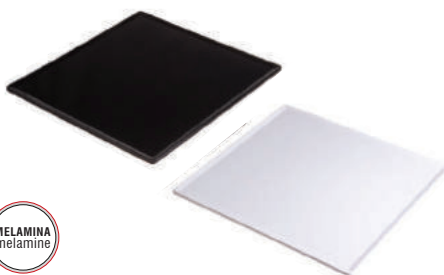

PRATO QUADRADO

plate plato assiete

| REF | (cm) | | |
|------------|-------|--------------------------|--------|
| 0730832060 | 29x29 | <input type="checkbox"/> | 06/024 |



SUPORTE

support soporte support

| REF | | (cm) | |
|------------|---|----------|--------|
| 0730836423 | 1 | Ø16.5x20 | 01/024 |
| 0730836413 | 2 | Ø16.5x10 | 01/024 |



PRATO SUPORTE COPO

plate plato assiette

| REF | (cm) | | |
|------------|-----------|--|--------|
| 0734124039 | 24x17.6x2 | | 40/080 |

cor marfim ivory color color marfil couleur ivoire



PRATO

plate plato assiette

| REF | (cm) | |
|------------|----------|--------|
| 0734122213 | 33x3.1 | 18/036 |
| 0734122215 | 37.8x3.2 | 12/024 |

cor marfim ivory color color marfil couleur ivoire



PRATO QUADRADO

plate plato assiette

| REF | (cm) | | |
|-------------|-----------|-------------------------------------|--------|
| 0732560092 | 41x41x4.5 | <input type="checkbox"/> | 06/012 |
| 07325600921 | 41x41x4.5 | <input checked="" type="checkbox"/> | 06/012 |



PRATO QUADRADO

plate plato plateau

| REF | (cm) | | |
|-------------|---------|-------------------------------------|--------|
| 0732562607 | 33x33x5 | <input type="checkbox"/> | 06/012 |
| 07325626071 | 33x33x5 | <input checked="" type="checkbox"/> | 06/012 |



TABULEIRO
platter fuente plat à servir

| REF | (cm) | |
|------------|-------------|--------|
| 0734126211 | 27x20.8x1.8 | 36/072 |

cor marfim ivory color color marfil couleur ivoire



TABULEIRO
platter fuente plat à servir

| REF | (cm) | |
|------------|-------------|--------|
| 0734121921 | 30x12.4x2.5 | 35/072 |

cor marfim ivory color color marfil couleur ivoire



TABULEIRO
platter fuente plat à servir

| REF | (cm) | |
|------------|---------|--------|
| 0734126213 | 33x23x2 | 24/048 |

cor marfim ivory color color marfil couleur ivoire



TABULEIRO
platter fuente plat à servir

| REF | (cm) | |
|------------|-------------|--------|
| 0734121911 | 45.2x30x2.2 | 10/020 |

cor marfim ivory color color marfil couleur ivoire



TABULEIRO
tray fuente plateau

| REF | (cm) | | |
|-------------|---------|-------------------------------------|--------|
| 0732561410 | 35x17x2 | <input type="checkbox"/> | 06/024 |
| 07325614101 | 35x17x2 | <input checked="" type="checkbox"/> | 06/024 |

07325614101 35x17x2 06/024



TABULEIRO
tray fuente plateau

| REF | (cm) | |
|------------|-----------|--------|
| 0732561413 | 30x22x1.8 | 12/048 |

0732561413 30x22x1.8 12/048



TABULEIRO
tray fuente plateau

| REF | (cm) | | |
|------------|-------|--------------------------|-------------------------------------|
| 0730832045 | 25x35 | <input type="checkbox"/> | <input checked="" type="checkbox"/> |
| 0730832044 | 18x35 | <input type="checkbox"/> | <input checked="" type="checkbox"/> |

0730832044 18x35 01/006



TABULEIRO
tray fuente plateau

| REF | (cm) | | |
|-------------|-----------|-------------------------------------|--------|
| 07325614111 | 35x24x2 | <input checked="" type="checkbox"/> | 06/012 |
| 0732561411 | 35x24x2 | <input type="checkbox"/> | 06/012 |
| 0732561413 | 30x22x1.8 | <input type="checkbox"/> | 12/048 |

0732561413 30x22x1.8 12/048



BANDEJA RECTANGULAR
tray fuente plateau

| REF | (cm) | |
|------------|-----------|--------|
| 0732566315 | 37x25x2.2 | 06/012 |

0732566315 37x25x2.2 06/012



BANDEJA
platter fuente plat à servir

| REF | (cm) | |
|------------|-------------|--------|
| 0734126016 | 39.4x27.8x2 | 16/032 |

cor marfim ivory color color marfil couleur ivoire





APRESENTAÇÃO

presentation presentación présentation



BANDEJA

platter fuente plat à servir

| REF | (cm) | |
|------------|-----------|--------|
| 0734121011 | 24x18x1.7 | 40/080 |

cor marfim ivory color color marfil couleur ivoire



TRAVESSA

platter fuente plat à servir

| REF | (cm) | |
|------------|---------------|--------|
| 0734126218 | 39.8x29.7x2.7 | 16/032 |

cor marfim ivory color color marfil couleur ivoire



TRAVESSA

platter fuente plat à servir



| REF | (cm) | |
|------------|---------------|--------|
| 0734129010 | 25.7x10.8x2.5 | 20/080 |
| 0734129012 | 30x12.4x2.5 | 24/048 |

cor marfim ivory color color marfil couleur ivoire



TRAVESSA

tray fuente plateau

| REF | (cm) | |
|------------|-----------|--------|
| 0732567019 | 32.8x14x3 | 12/024 |



TRAVESSA

tray fuente plateau

| REF | (cm) | |
|------------|---------|--------|
| 0732569025 | 54x16x2 | 01/012 |



TRAVESSA OVAL

oval tray fuente oval plateau ovale

| REF | (cm) | | |
|------------|-------------|-------------------------------------|--------|
| 0732560077 | 45x34.7x3.5 | <input type="checkbox"/> | 06/012 |
| 0732560071 | 45x34.7x3.5 | <input checked="" type="checkbox"/> | 06/012 |



TRAVESSA OVAL

oval tray fuente oval plateau ovale

| REF | (cm) | | |
|-------------|-----------|--------------------------|--------|
| 07325626214 | 57x21.5x4 | <input type="checkbox"/> | 06/012 |



TRAVESSA OVAL

oval tray fuente oval plateau ovale

| REF | (cm) | | |
|-------------|-----------|-------------------------------------|--------|
| 0732562621 | 71x28.5x4 | <input type="checkbox"/> | 06/012 |
| 07325626211 | 71x28.5x4 | <input checked="" type="checkbox"/> | 06/012 |
| 07325626212 | 61x23x4.5 | <input type="checkbox"/> | 04/008 |
| 07325626213 | 61x23x4.5 | <input checked="" type="checkbox"/> | 04/008 |





TRAVESSA OVAL
oval tray fuente oval plateau ovale

| REF | (cm) | | |
|-------------|---------|---|--------|
| 07325626201 | 52x36x7 | ■ | 04/008 |



TRAVESSA FUNDA
tray fuente plateau

| REF | (cm) | | |
|------------|----------|---|--------|
| 0732564521 | 53x26x11 | □ | 06/012 |



TRAVESSA
tray fuente plateau

| REF | (cm) | | |
|-------------|---------------|---|--------|
| 0732566553 | 46x31.5x11.5 | □ | 04/008 |
| 07325665531 | 46x31.5x11.5 | ■ | 04/008 |
| 07325665521 | 41.2x27x10.8 | ■ | 06/012 |
| 0732566551 | 36.8x23.6x9.8 | □ | 06/012 |
| 07325665511 | 36.8x23.6x9.8 | ■ | 06/012 |



TORTEIRA
tart tray bandeja para torta plat à cake

| REF | (cm) | | |
|------------|---------------|--|--------|
| 0734124135 | 33.1x15.8x1.7 | | 40/080 |

cor marfim ivory color color marfil couleur ivoire



GÔNDOLA
plate fuente plateau

| REF | (cm) | | |
|------------|------------|---|--------|
| 0732560053 | 19.5x7x3.8 | ■ | 06/060 |



PRATO QUADRADO
plate plato assiette

| REF | (cm) | | |
|-------------|-----------|---|--------|
| 07325600061 | 15x15x3.5 | ■ | 06/048 |



GÔNDOLA
plate fuente plateau

| REF | (cm) | | |
|-------------|---------------|---|--------|
| 07325603521 | 26.8x13.6x7.5 | ■ | 10/060 |
| 0732560352 | 22.9x11.6x6.5 | ■ | 10/080 |





APRESENTAÇÃO

presentation presentación présentation



TRAVESSA (SUSHI)
tray fuente plateau

| REF | (cm) | | |
|------------|-------------|---|--------|
| 0732567212 | 30.5x17.5x3 | ■ | 18/036 |



TRAVESSA (SUSHI)
tray fuente plateau

| REF | (cm) | | |
|------------|-------------|---|--------|
| 0732564310 | 24.5x16x1.8 | ■ | 18/036 |



TRAVESSA (SUSHI)
tray fuente plateau

| REF | (cm) | | |
|------------|-----------|---|--------|
| 0732560091 | 23x18x3.8 | ■ | 18/036 |



TRAVESSA (SUSHI)
tray fuente plateau

| REF | (cm) | | |
|-------------|---------------|---|--------|
| 07325610105 | 26.5x13.5x2.5 | ■ | 18/036 |



TRAVESSA (SUSHI)
tray fuente plateau

| REF | (cm) | | |
|-------------|---------------|---|--------|
| 07325601611 | 33.6x15.5x2.4 | ■ | 10/030 |
| 0732560161 | 30.5x13.5x1.8 | ■ | 10/030 |



SALADEIRA QUADRADA
salad bowl ensaladera saladier

| REF | (cm) | CL | |
|-------------|----------------|-----|----------|
| 07325600127 | 31x31x15 | 350 | □ 03/006 |
| 07325600102 | 25.5x25.5x11.5 | 330 | □ 08/024 |



SALADEIRA QUADRADA
salad bowl ensaladera saladier

| REF | (cm) | CL | |
|-------------|------------|-----|----------|
| 0732560010 | 27x27x10.5 | 430 | □ 06/012 |
| 07325600101 | 27x27x10.5 | 430 | ■ 06/012 |
| 0732560007 | 19x19x10 | 220 | □ 12/024 |
| 07325600071 | 19x19x10 | 220 | ■ 12/024 |



SALADEIRA QUADRADA
salad bowl ensaladera saladier

| REF | (cm) | CL | |
|-------------|-------------|-----|----------|
| 0732562612 | 37.5x37.5x9 | 510 | □ 06/012 |
| 07325626121 | 37.5x37.5x9 | 510 | ■ 06/012 |



SALADEIRA DIAGONAL
salad bowl ensaladera saladier

| REF | (cm) | CL | |
|-------------|--------------|----|----------|
| 0732560105 | 27.5x26.5x18 | 26 | □ 03/012 |
| 07325601051 | 27.5x26.5x18 | 26 | ■ 03/012 |



SALADEIRA FLOR
salad bowl ensaladera saladier

| REF | (cm) | CL | |
|------------|-------|-----|----------|
| 0732560520 | 30x13 | 330 | □ 06/012 |
| 0732560519 | 25x11 | 220 | □ 08/024 |



TAÇA QUADRADA
bowl bol bol

| REF | (cm) | |
|------------|-------------|--------|
| 0734122029 | 7.5x7.5x3.5 | 54/216 |

cor marfim ivory color color marfil couleur ivoire

**TAÇA RECTANGULAR**

bowl bol bol

| REF | (cm) | |
|------------|------------|--------|
| 0734120391 | 11.5x7x3.4 | 80/160 |

cor marfim ivory color color marfil couleur ivoire

**TAÇA DUPLA**

bowl bol bol

| REF | (cm) | |
|------------|--------------|--------|
| 0734128063 | 14.9x7.4x2.5 | 50/200 |

cor marfim ivory color color marfil couleur ivoire

**TAÇA**

bowl bol bol

| REF | (cm) | |
|------------|----------|--------|
| 0734126745 | Ø10.6x11 | 22/088 |
| 0734126755 | Ø14x11.6 | 16/064 |

**TIGELA**

bowl bol bol

| REF | (cm) | CL | |
|------------|-------------|------|--------|
| 0732560045 | Ø10.5x9.5x5 | 25.5 | 12/048 |

**TIGELA**

bowl bol bol

| REF | (cm) | CL | |
|-------------|-----------|----|--------|
| 07325600103 | Ø10.5x4.5 | 24 | 12/120 |

**TIGELA**

bowl bol bol

| REF | (cm) | | |
|------------|---------|----|--------|
| 0732560004 | Ø10.5x8 | 30 | 12/072 |

**TIGELA**

bowl bol bol

| REF | (cm) | CL | |
|------------|-------|----|--------|
| 0732560010 | Ø15.8 | 70 | 06/048 |

**TIGELA**

bowl bol bol

| REF | (cm) | CL | |
|-------------|-----------|------|--------|
| 0732560075 | Ø19x10 | 130 | 06/024 |
| 0732560065 | Ø16.5x8.5 | 80 | 06/048 |
| 07325600551 | Ø14x7 | 50 | 15/060 |
| 07325600451 | Ø11.5x6 | 28.5 | 12/096 |
| 0732560061 | Ø9.7x5 | 16 | 30/120 |

**TIGELA**

bowl bol bol

| REF | (cm) | CL | |
|-------------|---------|-----|--------|
| 0732560009 | Ø22.8x9 | 145 | 12/024 |
| 07325600072 | Ø17.7x7 | 60 | 06/036 |
| 0732560055 | Ø14x6 | 30 | 18/072 |

**TAÇA**

bowl bol bol

| REF | (cm) | CL | |
|------------|--------|-----|--------|
| 0732560502 | Ø6.8x2 | 3.5 | 48/288 |

**TAÇA**

bowl bol bol

| REF | (cm) | CL | |
|------------|--------|----|--------|
| 0732563002 | Ø7x3.5 | 60 | 24/192 |
| 0732563011 | Ø6x3.5 | 44 | 16/128 |



APRESENTAÇÃO

presentation presentación présentation



1



2



3



TAÇA LÁGRIMA

bowl bol bol

| REF | (cm) | CL | |
|------------|---------------|--------|--------|
| 0732560534 | 1 8.8x7.4x3.4 | 6 | 40/240 |
| 0732560006 | 2 8.5x5 | 40/420 | |
| 0732565611 | 3 10.3x6.6 | 5 | 30/120 |



TAÇA OVAL

bowl bol bol

| REF | (cm) | CL | |
|------------|----------|----|--------|
| 0732560903 | 10x9x5.5 | - | 40/240 |



NOVO
new

TIGELA

bowl bol bol

| REF | (cm) | CL | |
|------------|--------|----|--------|
| 0732567118 | Ø9x4.5 | - | 20/009 |



NOVO
new

CAÇAROLA MINI

casserole cacerola cocotte

| REF | (cm) | CL | |
|------------|-------------|----|--------|
| 0732560015 | 13x10.3x6.2 | - | 12/014 |



FRIGIDEIRA

au gratin plato gratinados plat à gratin

| REF | (cm) | |
|------------|-----------|--------|
| 0732563102 | 25.5x17x3 | 12/060 |



NOVO
new

PLATO DUAS DIVISÓRIAS

plate plato assiette

| REF | (cm) | |
|------------|--------------|--------|
| 0732560060 | 14.9x7.3x2.9 | 20/009 |



PLATO DUPLO

plate plato assiette

| REF | (cm) | |
|------------|------------|---------|
| 0734122045 | 11.2x7x1.9 | 184/368 |

cor marfim ivory color color marfil couleur ivoire



PRATO P/BOLO

cake stand portatartas guéridon pâtisserie

| REF | (cm) | |
|------------|--------|--------|
| 0732566953 | Ø30x14 | 06/012 |



COLHER

spoon cuchara cuillère

| REF | (cm) | |
|------------|----------|--------|
| 0734122036 | 12x8x3.5 | 56/224 |

cor marfim ivory color color marfil couleur ivoire



COLHER DEGUSTAÇÃO

tasting spoon cuchara degustación cuillère dégustation

| REF | (cm) | |
|------------|------------|----------|
| 0734127055 | 14x4.3x4.5 | 250/1000 |

cor marfim ivory color color marfil couleur ivoire



CONTENTORES em melamina

melamine containers contenedores melamina bacs melamine



Os contentores em melamina caracterizam-se pela sua durabilidade, qualidade, resistência, superfície brilhante e elegante.

Evitar alterações bruscas de temperatura. Não suporta superfícies quentes.

The containers in melamine are characterized by their durability, quality, resistance, shiny and elegant surface. Avoid sudden changes in temperature. Does not support hot surfaces.

Los contenedores en melamina se caracterizan por su durabilidad, calidad, fuerza, superficie brillante y elegante.

Evitar los cambios bruscos de temperatura. No es compatible con las superficies calientes.

Les containers en mélamine sont caractérisés par leur durabilité, qualité, force, une surface brillante et élégante. Évitez les changements brusques de température. Ne supporte pas les surfaces chaudes.



CONTENTOR
container contenedor bac

| REF | (cm) | LT | | |
|-------------|-----------|-----|-------------------------------------|--------|
| 07325600241 | 54x16x6.5 | 2.6 | <input type="checkbox"/> | 06/012 |
| 07325600244 | 54x16x6.5 | 2.6 | <input checked="" type="checkbox"/> | 06/012 |



CONTENTOR
container contenedor bac

| REF | (cm) | LT | | |
|-------------|-------------|-----|-------------------------------------|--------|
| 07325600111 | 53x32.5x6.5 | 7.4 | <input type="checkbox"/> | 03/006 |
| 07325600114 | 53x32.5x6.5 | 7.4 | <input checked="" type="checkbox"/> | 03/006 |



CONTENTOR
container contenedor bac

| REF | (cm) | LT | | |
|-------------|-------------|----|-------------------------------------|--------|
| 07325600121 | 32.5x26x6.5 | 3 | <input type="checkbox"/> | 06/012 |
| 07325600124 | 32.5x26x6.5 | 3 | <input checked="" type="checkbox"/> | 06/012 |



CONTENTOR
container contenedor bac

| REF | (cm) | LT | | |
|-------------|---------------|-----|-------------------------------------|--------|
| 07325600131 | 32.5x17.5x10 | 2.7 | <input checked="" type="checkbox"/> | 06/012 |
| 0732560013 | 32.5x17.5x6.5 | 1.8 | <input checked="" type="checkbox"/> | 06/012 |





APRESENTAÇÃO

presentation presentación présentation



MELAMINA melamine
GN 1/6



CONTENTOR
container contenedor bac

| REF | (cm) | LT | | |
|-------------|-------------|-----|---|--------|
| 07325600161 | 17.5x16x10 | 1 | ■ | 08/016 |
| 0732560016 | 17.5x16x6.5 | 0.8 | ■ | 06/024 |



MELAMINA melamine
GN 1/1

TRAVESSA
tray fuente plateau

| REF | (cm) | | |
|-------------|---------|---|--------|
| 0732560011 | 53x32x2 | □ | 06/012 |
| 07325600112 | 53x32x2 | ■ | 06/012 |
| 07325600113 | 53x32x2 | ■ | 06/012 |



MELAMINA melamine
GN 1/2

TRAVESSA
tray fuente plateau

| REF | (cm) | | |
|-------------|-------------|---|--------|
| 0732560012 | 32.5x26.5x2 | □ | 06/024 |
| 07325600122 | 32.5x26.5x2 | ■ | 06/024 |
| 07325600123 | 32.5x26.5x2 | ■ | 06/024 |



MELAMINA melamine
GN 2/4

TRAVESSA
tray fuente plateau

| REF | (cm) | | |
|-------------|-----------|---|--------|
| 0732560024 | 53x16.2x2 | □ | 06/024 |
| 07325600242 | 53x16.2x2 | ■ | 06/024 |
| 07325600243 | 53x16.2x2 | ■ | 06/024 |

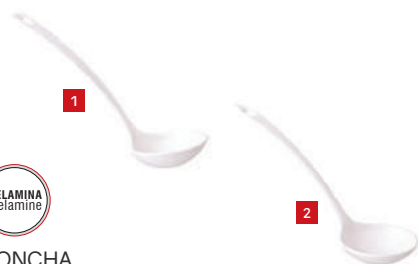

MELAMINA melamine

CONCHA
ladle cachilo louche

| REF | (cm) | |
|-------------|------------|---------|
| 0734127010 | 20.4x6.5x2 | 250/500 |
| 07341270101 | 20.4x6.5x2 | 150/600 |

cor marfim ivory color color marfil couleur ivoire



MELAMINA melamine

COLHER SERVIR
spoon cuchara cuillère

| REF | (cm) | |
|------------|--------------|---------|
| 0734127009 | 31.7x7.3x4.6 | 100/200 |

cor marfim ivory color color marfil couleur ivoire



MELAMINA melamine

COLHER PERFURADA
spoon cuchara cuillère

| REF | (cm) | |
|------------|----------|---------|
| 0734127011 | 27.5x7.5 | 150/300 |

cor marfim ivory color color marfil couleur ivoire

PORCELANA
PORCELAIN
PORCELANA
PORCELAINE



PLACA EXPOSITORA
display plate soporte presentación présentoir

| REF | (cm) | |
|-------------|-----------|--------|
| 02200202155 | 35.5x25.5 | 01/008 |
| 02200202154 | 24x18 | 01/024 |
| 02200202153 | 13x18 | 06/072 |

PORCELANA
PORCELAIN
PORCELANA
PORCELAINE

**NOVO
new**



PRATO EXPOSITOR
plate plato assiette

| REF | (cm) | |
|------------|---------|--------|
| 0234110063 | Ø38.6x7 | 03/009 |

PORCELANA
PORCELAIN
PORCELANA
PORCELAINE

**NOVO
new**



TRAVESSA OVAL
platter fuente plat à servir

| REF | (cm) | |
|------------|---------------|--------|
| 0234110026 | 39.7x24.7x9.2 | 02/012 |

PORCELANA
PORCELAIN
PORCELANA
PORCELAINE



FRUTEIRO
fruit basket frutero panier à fruit

| REF | (cm) | |
|------------|---------|--------|
| 0230524870 | 47x47x9 | 01/004 |

PORCELANA
PORCELAIN
PORCELANA
PORCELAINE



FRUTEIRO
fruit basket frutero panier à fruit

| REF | (cm) | |
|------------|------|--------|
| 0230760798 | Ø34 | 01/004 |

PORCELANA
PORCELAIN
PORCELANA
PORCELAINE

**NOVO
new**



SALADEIRA EXPOSITORA
salad bowl ensaladera saladier

| REF | (cm) | |
|------------|----------------|--------|
| 0234110067 | 27.9x25.4x12.9 | 02/012 |

PORCELANA
PORCELAIN
PORCELANA
PORCELAINE



SALADEIRA GÔNDOLA
salad bowl ensaladera saladier

| REF | (cm) | CL | |
|-------------|------------|-----|--------|
| 02307676708 | 36.5x19x14 | 310 | 01/008 |
| 02307676712 | 26x14x10 | 90 | 02/016 |
| 02307676714 | 20x11x8 | 30 | 04/032 |

PORCELANA
PORCELAIN
PORCELANA
PORCELAINE



CONJUTNO 3 TRAVESSAS
set 3 trays conjunto 3 fuentes ensemble 3 plateaux

| REF | (cm) | |
|------------|---------|--------|
| 0230466780 | 47x34x8 | 01/006 |

PORCELANA
PORCELAIN
PORCELANA
PORCELAINE



TABULEIRO
tray fuente plateau

| REF | (cm) | |
|------------|---------|--------|
| 0230460016 | 41x33x3 | 02/012 |

PORCELANA
PORCELAIN
PORCELANA
PORCELAINE



TABULEIRO
tray fuente plateau

| REF | (cm) | |
|------------|---------|--------|
| 0230760356 | 34.5x22 | 01/012 |

PORCELANA
PORCELAIN
PORCELANA
PORCELAINE



CONTENTOR
container contenedor bac

| REF | (cm) | LT | |
|------------|-----------|--------|------------|
| 0230760410 | 1 31x26x7 | GN 1/2 | 3.2 01/006 |
| 0230760409 | 2 32x17x7 | GN 1/3 | 1.9 01/008 |





APRESENTAÇÃO

presentation presentación présentation



INOX

TERRINA
tureen sopera soupière

| REF | (cm) | LT | |
|------------|----------|-----|--------|
| 0433651162 | Ø22x13.5 | 2.6 | 01/020 |
| 0433651164 | Ø24x15 | 5 | 01/020 |



INOX

TERRINA
tureen sopera soupière

| REF | (cm) | LT | |
|------------|--------|----|--------|
| 0433651156 | Ø26x17 | 5 | 01/006 |
| 0433651156 | Ø26x17 | 5 | 01/006 |



INOX

TERRINA
tureen sopera soupière

| REF | (cm) | LT | |
|------------|------|----|--------|
| 0433650114 | Ø26 | 4 | 01/006 |



INOX

NOVO
new

ASSADEIRA OVAL C/TAMPA
roaster with lid rustidera con tapa plat à rotir avec couvercle

| REF | (cm) | |
|------------|------|--------|
| 0433651141 | 41 | 01/001 |



INOX

TRAVESSA OVAL C/3 DIVISÓRIAS
oval tray fuente oval plateau ovale

| REF | (cm) | |
|------------|------|--------|
| 0432430353 | 35 | 01/040 |



INOX

TRAVESSA OVAL FUNDA
oval tray fuente oval plateau ovale

| REF | (cm) | |
|-------------|------|--------|
| 04324300304 | 30 | 01/050 |
| 04324300252 | 25 | 01/100 |



INOX

TRAVESSA OVAL FUNDA
oval tray fuente oval plateau ovale

| REF | (cm) | |
|-------------|-------|--------|
| 04324300203 | 20x14 | 01/100 |
| 0432430017 | 17x11 | 01/100 |



INOX

BANDEJA P/CONFEITARIA
tray fuente plateau

| REF | (cm) | |
|------------|-------|--------|
| 0433651329 | 30x21 | 01/050 |



INOX

BANDEJA P/CONFEITARIA
tray fuente plateau

| REF | (cm) | |
|-------------|-----------|--------|
| 04336591301 | 21.5x16.5 | 20/060 |



INOX

BANDEJA P/CONFEITARIA
tray fuente plateau

| REF | (cm) | |
|-------------|---------|--------|
| 04312600067 | 31x24.5 | 01/030 |



INOX

BANDEJA RECTANGULAR
tray fuente plateau

| REF | (cm) | |
|------------|---------|--------|
| 0433654332 | 32x24 | 01/025 |
| 0433654328 | 28x21.5 | 01/025 |
| 0433654325 | 25x19 | 01/025 |



TABULEIRO
tray fuente plateau

| REF | (cm) | |
|------------|-------|--------|
| 0433651329 | 30x21 | 01/050 |



TABULEIRO
tray fuente plateau

| REF | (cm) | |
|------------|-------|--------|
| 0432430044 | 44x32 | 01/025 |
| 0432430041 | 41x28 | 01/025 |
| 0733610319 | 27x20 | 01/050 |



TABULEIRO
tray fuente plateau

| REF | (cm) | |
|------------|-----------|--------|
| 0432612010 | 32.5x26.5 | 01/040 |



TABULEIRO
tray fuente plateau

| REF | (cm) | |
|------------|---------|--------|
| 0430683711 | 53x32.5 | 01/010 |



TABULEIRO
tray fuente plateau

| REF | (cm) | |
|------------|-------|--------|
| 0432610222 | 56x42 | 01/008 |



BANDEJA
tray fuente plateau

| REF | (cm) | |
|------------|-----------|--------|
| 0432610220 | 64x37x3.8 | 01/010 |



BANDEJA
tray fuente plateau

| REF | (cm) | |
|------------|---------|--------|
| 0430683701 | 52.5x32 | 01/006 |



BANDEJA REDONDA
round tray fuente redonda plateau rond

| REF | (cm) | |
|------------|---------|--------|
| 0433650701 | Ø40x1.7 | 01/015 |



BANDEJA REDONDA
round tray fuente redonda plateau rond

| REF | (cm) | |
|-------------|------|--------|
| 0432610122 | Ø56 | 01/008 |
| 04306839011 | Ø35 | 06/012 |



BANDEJA REDONDA
round tray fuente redonda plateau rond

| REF | (cm) | |
|-------------|-------|--------|
| 04324300351 | Ø35x2 | 01/024 |



BANDEJA REDONDA
round tray fuente redonda plateau rond

| REF | (cm) | |
|-------------|---------|--------|
| 04324300402 | Ø40x2.5 | 01/024 |



BANDEJA OVAL
oval tray fuente oval plateau ovale

| REF | (cm) | |
|------------|---------------|--------|
| 0432610322 | 57.5x44.5x1.8 | 01/008 |
| 0432610320 | 50.5x36.5x1.8 | 01/008 |



APRESENTAÇÃO

presentation presentación présentation



INOX

TRAVESSA RECT. C/2 DIVISÓRIAS
tray fuente plateau

| REF | (cm) | |
|------------|-------|--------|
| 0432430002 | 22x11 | 01/170 |

INOX

TAÇA QUADRADA
bowl cuenco bol

| REF | (cm) | |
|------------|-----------|--------|
| 0432790037 | 8.5x8.5x4 | 10/144 |

INOX

SUPORE BOLO
cake stand portataras guéridon pâtisserie

| REF | (cm) | |
|------------|--------|--------|
| 0433656100 | Ø32x17 | 01/006 |



PC

PRATO ROTATIVO
plate plato assiette

| REF | (cm) | | |
|------------|-----------|---|--------|
| 0732960389 | Ø33.5x7.4 | <input checked="" type="checkbox"/> <input type="checkbox"/> <input type="checkbox"/> | 01/006 |



PC

PRATO REDONDO
plate plato assiette

| REF | (cm) | | |
|------------|---------|---|--------|
| 0732960383 | Ø34.5x8 | <input type="checkbox"/> <input checked="" type="checkbox"/> <input type="checkbox"/> | 01/009 |



PC

PRATO REDONDO 3 NÍVEIS
plate plato assiette

| REF | (cm) | | |
|------------|-----------------|--|--------|
| 0732960386 | Ø25 Ø30 Ø35 | <input checked="" type="checkbox"/> <input type="checkbox"/> | 01/009 |



PC

PRATO QUADRADO
plate plato assiette

| REF | (cm) | | |
|------------|---------|---|--------|
| 0732960381 | 35x35x3 | <input type="checkbox"/> <input checked="" type="checkbox"/> <input type="checkbox"/> | 01/016 |



PC

BANDEJA RECTANGULAR
tray fuente plateau

| REF | (cm) | | |
|------------|---------|---------------|--------|
| 0730262113 | 53x32x2 | GN 1/1 | 01/012 |
| 0730261310 | 32x26x2 | GN 1/2 | 01/024 |



PC

TAÇA
bowl bol bol

| REF | (cm) | | | |
|------------|----------|--------------------------|-------------------------------------|--------|
| 0732960723 | Ø7x3.5 | <input type="checkbox"/> | <input checked="" type="checkbox"/> | 06/024 |
| 0732960722 | Ø5.6x2.5 | <input type="checkbox"/> | <input checked="" type="checkbox"/> | 16/128 |



PC

SALADEIRA
salad bowl ensaladera saladier

| REF | (cm) | | | |
|------------|------|-------------------------------------|--------------------------|--------|
| 0732960299 | Ø26 | <input checked="" type="checkbox"/> | <input type="checkbox"/> | 00/020 |



PC

SALADEIRA
salad bowl ensaladera saladier

| REF | (cm) | LT | |
|------------|------------|------|--------|
| 0733638457 | Ø37.5x13.5 | 9.75 | 01/012 |
| 0733638458 | Ø30x11 | 4.75 | 01/012 |



INOX

PS

SALADEIRA
salad bowl ensaladera saladier

| REF | (cm) | LT | |
|------------|---------|-------|--------|
| 0734040035 | 29.5x22 | 6/4.5 | 01/006 |



PC

SALADEIRA + TALHERES
salad bowl + servers ensaladera + cubiertos saladier + couvert

| REF | (cm) | |
|------------|----------|--------|
| 0731250004 | Ø28.5x23 | 01/003 |



PC

PRATO C/TAMPA
plate plato assiette

| REF | (cm) | |
|------------|------------|--------|
| 0732960363 | 33x33x13.5 | 01/007 |



ACRILICO ACRILICO ACRILIQUE

NOVO new

PRATO C/TAMPA
plate plato assiette

| REF | (cm) | |
|------------|--------------|--------|
| 0731250169 | 31.2x31.2x23 | 01/004 |



PC

EXPOSITOR MULTIFUNÇÕES
plate plato assiette

| REF | (cm) | |
|------------|----------|--------|
| 0731252433 | 36x36x16 | 01/006 |



ACRILICO ACRILICO ACRILIQUE

PRATO C/TAMPA
plate plato assiette

| REF | (cm) | |
|------------|----------|--------|
| 0430948969 | Ø31x16.5 | 01/004 |

PC

PRATO C/TAMPA
plate plato assiette

| REF | (cm) | |
|------------|------|--------|
| 0732960375 | ** | 01/006 |

** prato plate plato assiette Ø34.5x4.5
câmpanula plate cover cubreplatos cloche Ø35x15

CÂMPANULA
plate cover cubreplatos cloche

| REF | (cm) | |
|------------|--------|--------|
| 0732960374 | Ø35x15 | 01/035 |





APRESENTAÇÃO

presentation presentación présentation



buffet buffet buffet buffet



PS

PRATO C/TAMPA
plate plato assiette

| REF | (cm) | |
|------------|----------|--------|
| 0732960324 | Ø28.5x14 | 01/012 |



PC

CÂMpanULA
plate cover cubreplatos cloche

| REF | (cm) | |
|------------|--------|--------|
| 0733800021 | Ø27x15 | 01/004 |



PS

CÂMpanULA
plate cover cubreplatos cloche

| REF | (cm) | |
|------------|------|--------|
| 0732960316 | Ø25 | 01/012 |



PS

CÂMpanULA + PRATO
plate cover + plate cubreplatos + plato cloche + assiette

| REF | (cm) | |
|------------|--------|--------|
| 0732960318 | Ø36x17 | 01/018 |



PC

CÂMpanULA
plate cover cubreplatos cloche

| REF | (cm) | |
|------------|--------|--------|
| 0730830659 | Ø33x29 | 20/120 |



ACRILICO
ACRYLIC
ACRILICO
ACRYLIQUE

CÂMpanULA + PRATO
plate cover + plate cubreplatos + plato cloche + assiette

| REF | (cm) | |
|-------------|------|--------|
| 04307229685 | Ø38 | 01/006 |



ACRILICO
ACRYLIC
ACRILICO
ACRYLIQUE

CÂMpanULA
plate cover cubreplatos cloche

| REF | (cm) | |
|-------------|------|--------|
| 04307229684 | Ø38 | 01/006 |



PC

PRATO + TAMPA BASCULANTE
plate + plate cover plato + cubreplatos assiette + cloche

| REF | (cm) | |
|------------|----------|--------|
| 0733631600 | Ø41x19.5 | 01/016 |



PC

PRATO C/TAMPA BASCULANTE
plate plato assiette

| REF | (cm) | |
|------------|--------|--------|
| 0730830019 | Ø44x22 | 01/001 |



PC

PRATO C/TAMPA BASCULANTE
plate plato assiette

| REF | (cm) | |
|------------|--------|--------|
| 0730830055 | Ø49x23 | 01/001 |



PC

GN 1/2

TAMPA BASCULANTE
plate cover cubreplatos cloche

| REF | (cm) | |
|------------|----------|--------|
| 0730830708 | 33x27x21 | 01/120 |



PC

GN 1/1

VITRINE C/TAMPA
display vitrina vitrine

| REF | (cm) | |
|------------|----------|--------|
| 0732960019 | 54x32x18 | 01/002 |



ACRILICO
ACRYLIC
ACRYLIQUE

GN 1/1

CÂMPANULA
plate cover cubreplatos cloche

| REF | (cm) | |
|-------------|---------|--------|
| 04307200024 | 54.5x35 | 01/024 |

PC

CÂMPANULA RECTANGULAR
plate cover cubreplatos cloche

| REF | (cm) | |
|------------|---------------|--------|
| 0732960416 | 31.2x11.5x8.7 | 01/012 |

PC

TABULEIRO RECTANGULAR
tray fuente plateau

| REF | (cm) | |
|------------|---------------|--------|
| 0732960376 | 30.5x10.8x1.6 | 01/030 |



PC

GN 1/1

VITRINE RECTANGULAR
display vitrina vitrine

| REF | (cm) | |
|------------|--------------|--------|
| 0732960020 | 54.5x33x23.3 | 01/002 |

PC

GN 1/2

CÂMPANULA
plate cover cubreplatos cloche

| REF | (cm) | |
|------------|------------|--------|
| 0732960379 | 33x27x13.2 | 01/012 |

PC

GN 1/2

TABULEIRO
tray fuente plateau

| REF | (cm) | |
|------------|-------------|--------|
| 0732960378 | 32.5x26.5x2 | 01/024 |



MELAMINA
melamine

PC

VITRINE RECTANGULAR
display vitrina vitrine

| REF | (cm) | |
|------------|----------|--------|
| 0732131012 | 42x29x15 | 01/006 |

PC

GN 1/1

CÂMPANULA
plate cover cubreplatos cloche

| REF | (cm) | |
|------------|--------------|--------|
| 0732960380 | 53.5x33x15.5 | 01/006 |

PC

GN 1/1

TABULEIRO
tray fuente plateau

| REF | (cm) | |
|------------|-------------|--------|
| 0732960418 | 53x32.5x2.1 | 01/020 |





APRESENTAÇÃO

presentation presentación présentation



VITRINE REDONDA

round display vitrina redonda vitrine ronde

| REF | (cm) | |
|------------|--------|--------|
| 0432423001 | Ø39x31 | 01/001 |



VITRINE REDONDA

round display vitrina redonda vitrine ronde

| REF | (cm) | |
|------------|--------|-------|
| 0432613120 | Ø51x30 | 01/01 |

pode ser colocado refrigerador na base da vitrine para cuvetes (geladas)
 refrigerator can be placed in the base of the display case for cuvettes (cold)
 se puede colocar refrigerador en la base de la vitrina para cubetas (heladas)
 peut être placé dans la base de vitrine du réfrigérateur pour les flacons (congélation)



para comida quente
 for hot food
 para la comida caliente
 pour les plats chauds



VITRINE REDONDA

round display vitrina redonda vitrine ronde

| REF | (cm) | |
|-------------|--------|--------|
| 04324230011 | Ø39x40 | 01/001 |



VITRINE RECTANGULAR GN

display vitrina vitrine

| REF | (cm) | |
|------------|-------|--------|
| 0432612140 | 56x36 | 01/001 |



VITRINE RECTANGULAR

display vitrina vitrine

| REF | (cm) | |
|------------|----------|--------|
| 0432423002 | 61x42x30 | 01/001 |



VITRINE RECTANGULAR

display vitrina vitrine

| REF | (cm) | |
|------------|----------|--------|
| 1330388804 | 58x37x50 | 01/001 |



VITRINE RECTANGULAR

display vitrina vitrine

| REF | (cm) | |
|-------------|--------------|--------|
| 04324230021 | 51.5x31.5x30 | 01/001 |



VITRINE C/TAMPA

display vitrina vitrine

| REF | (cm) | |
|------------|----------|--------|
| 0730830340 | 25x34x34 | 01/023 |



EXPOSITOR BUFFET C/3 TAÇAS
buffet display expositor buffet présentoir buffet

| REF | (cm) | |
|------------|--------------|--------|
| 0430685022 | 27x20x51.5 | 01/001 |
| 0430685021 | 22x17.5x44.5 | 01/001 |

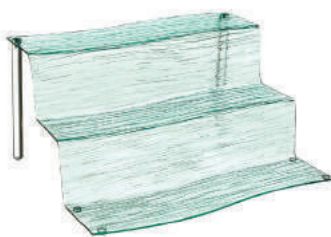

EXPOSITOR
display expositor présentoir

| REF | (cm) | |
|------------|------------|--------|
| 0731250149 | 40x32x18.4 | 01/004 |



EXPOSITOR
display expositor présentoir

| REF | (cm) | |
|------------|-------------------|--------|
| 0730830118 | Ø20 Ø30 Ø40x5 | 01/001 |



EXPOSITOR BUFFET C/3 TAÇAS
buffet display expositor buffet présentoir buffet

| REF | (cm) | |
|------------|-------------------------|--------|
| 0430940231 | 16.5x15x44 Ø14x8 (x3) | 01/006 |



EXPOSITOR BUFFET C/4 TAÇAS
buffet display expositor buffet présentoir buffet

| REF | (cm) | |
|------------|---------------|--------|
| 0432790014 | 70 Ø22 (x4) | 01/002 |



RECIPIENTE C/TAMPA
box with lid caja con tapa boîte avec couvercle

| REF | (cm) | LT | |
|------------|------------|----|--------|
| 0732960360 | 25x25x34.5 | 20 | 01/006 |



CONJ. 2 FRASCOS C/SUPORE
2 bottles with stand
2 botellas con soporte
2 bouteilles avec support

| REF | (cm) | LT | |
|------------|----------|----------|--------|
| 0730830084 | 43x21x20 | 2.2 (x2) | 00/001 |



FRASCO C/SUPORE
bottle with stand botella con soporte bouteille avec support

| REF | (cm) | LT | |
|------------|----------|-----|--------|
| 0730830091 | 21x21x20 | 2.2 | 00/001 |



APRESENTAÇÃO

presentation presentación présentation



PC

FRASCO
bottle botella bouteille

| REF | (cm) | CL | |
|------------|----------|-----|--------|
| 0732960123 | Ø14x13.5 | 180 | 00/012 |



PC

RECIPIENTE C/COLHER
bottle with spoon botella con cuchara bouteille avec cuillère

| REF | (cm) | ML | |
|------------|-----------|-----|--------|
| 0730260250 | Ø8.4x10.4 | 250 | 01/096 |



PC

DISPENSADOR CEREAIS TRIPLO ROTATIVO
cereal dispenser dispensador cereales distributeur céréales

| REF | (cm) | LT | |
|------------|----------|----------|--------|
| 0730830719 | 26x26x46 | 1.5 (x3) | 01/024 |



PC

DISPENSADOR CEREAIS TRIPLO
cereal dispenser dispensador cereales distributeur céréales

| REF | (cm) | LT | |
|------------|------------|----------|--------|
| 0730837243 | 40x15.5x44 | 1.5 (x3) | 01/012 |



PC

DISPENSADOR CEREAIS TRIPLO P/PAREDE
cereal dispenser dispensador cereales distributeur céréales

| REF | (cm) | LT | |
|------------|------------|----------|--------|
| 0730837253 | 40x15.5x33 | 1.5 (x3) | 01/012 |



INOX

PC

DISPENSADOR CEREAIS
cereal dispenser dispensador cereales distributeur céréales

| REF | (cm) | LT | |
|------------|------------|----|--------|
| 0430682051 | 23x23.5x65 | 8 | 01/001 |



INOX

PC

DISPENSADOR CEREAIS DUPLO
cereal dispenser dispensador cereales distributeur céréales

| REF | (cm) | LT | |
|------------|------------|--------|--------|
| 0430682052 | 46.5x36x67 | 8 (x2) | 01/001 |



PC

DISPENSADOR FRUTOS SECOS/CEREAIS
dry fruits/cereal dispenser
dispensador frutas secas/cereales
distributeur fruits secs/céréales

| REF | (cm) | LT | |
|------------|----------------|----------|--------|
| 0730830143 | 34.5x16.5x43.3 | 1.5 (x3) | 01/018 |





INOX

CESTO P/PÃO
bread basket cesta de pan corbeille à pain

| REF | (cm) | |
|------------|---------|--------|
| 0433655220 | Ø20x8.5 | 01/073 |
| 0433655218 | Ø18x8.5 | 01/040 |



INOX

CESTO P/PÃO
bread basket cesta de pan corbeille à pain

| REF | (cm) | |
|-------------|------|--------|
| 04309713071 | Ø22 | 06/048 |
| 04309713072 | Ø17 | 06/072 |



INOX

CESTO P/PÃO
bread basket cesta de pan corbeille à pain

| REF | (cm) | |
|------------|------|--------|
| 0434070237 | Ø22 | 01/120 |



INOX

FRUTEIRO
fruit basket frutero panier à fruit

| REF | (cm) | |
|------------|--------|--------|
| 0434070235 | Ø28x12 | 01/120 |
| 0434070234 | Ø26x12 | 01/120 |



PP

CESTO P/PÃO REDONDO
bread basket cesta de pan corbeille à pain

| REF | (cm) | |
|-------------|-------|--------|
| 07321320401 | Ø23x8 | 05/060 |
| 0732132040 | Ø23x8 | 05/060 |



PP

CESTO P/PÃO
bread basket cesta de pan corbeille à pain

| REF | (cm) | |
|-------------|-----------|--------|
| 0734082005 | Ø18.5x7.5 | 01/060 |
| 07340820051 | Ø18.5x7.5 | 01/060 |
| 07340820052 | Ø18.5x7.5 | 01/100 |



PP

CESTO REDONDO
basket cesta corbeille

| REF | (cm) | |
|------------|-------|--------|
| 0734088005 | Ø21x7 | 01/012 |



PP

CESTO REDONDO
basket cesta corbeille

| REF | (cm) | |
|-------------|-------|--------|
| 04307210183 | Ø18x7 | 01/009 |



PP

CESTO REDONDO
basket cesta corbeille

| REF | (cm) | |
|-------------|-------|--------|
| 04307210251 | Ø25x6 | 01/012 |



PP

CESTO REDONDO
basket cesta corbeille

| REF | (cm) | |
|------------|-------|--------|
| 0732131004 | Ø23x7 | 01/010 |



APRESENTAÇÃO

presentation presentación presentación



PP

CESTO REDONDO
basket cesta corbeille

| REF | (cm) | |
|------------|-----------|--------|
| 0734089018 | Ø18.5x7.5 | 01/120 |



PP

CESTO REDONDO
basket cesta corbeille

| REF | (cm) | |
|------------|--------|--------|
| 0732131014 | Ø39x12 | 01/030 |



PP

CESTO OVAL
basket cesta corbeille

| REF | (cm) | |
|------------|--------------|--------|
| 0732131015 | 40.5x30x5/12 | 01/030 |



PP

CESTO P/PÃO OVAL
bread basket cesta de pan corbeille à pain

| REF | (cm) | | |
|-------------|--------------|---|--------|
| 07321330401 | Ø23.5x15x7.5 | ■ | 01/006 |
| 0732133041 | Ø27.5x17x7.5 | ■ | 05/060 |



PP

CESTO OVAL
basket cesta corbeille

| REF | (cm) | | |
|------------|-------------|---|--------|
| 0734088006 | 18x12x7 | ■ | 01/100 |
| 0734088007 | 27.5x17x7.5 | ■ | 01/090 |



PP

CESTO OVAL
basket cesta corbeille

| REF | (cm) | |
|-------------|----------|--------|
| 04307230181 | Ø18x12x7 | 01/014 |
| 04307230252 | Ø25x17x7 | 01/021 |



PC

CESTO REDONDO
basket cesta corbeille

| REF | (cm) | |
|------------|-------|--------|
| 0732960661 | Ø23x8 | 01/100 |
| 0732960659 | Ø19.5 | 01/100 |



PC

CESTO OVAL
basket cesta corbeille

| REF | (cm) | |
|------------|-------------|--------|
| 0732960665 | 27.8x20x9.5 | 01/120 |
| 0732960663 | 24x17x9.5 | 01/120 |



PC

CESTO RECTANGULAR
basket cesta corbeille

| REF | (cm) | |
|------------|---------------|--------|
| 0732960667 | 25.5x17.5x7.2 | 01/076 |



PP

CESTO P/PÃO
bread basket cesta de pan corbeille à pain

| REF | (cm) | |
|------------|------|--------|
| 0732960664 | 24 | 01/072 |



PP

CESTO REDONDO
basket cesta corbeille

| REF | (cm) | | |
|------------|--------|---|--------|
| 0734082266 | Ø36x10 | ■ | 01/020 |
| 0734082261 | Ø36x10 | ■ | 01/020 |



PC

TAMPA
lid tapa couvercle

| REF | (cm) | |
|-------------|----------|--------|
| 07340800061 | Ø37x18.5 | 01/005 |



PP

CESTO REDONDO
basket cesta corbeille

| REF | (cm) | | |
|-------------|--------|--|--------|
| 0734082098 | Ø40x10 | | 01/012 |
| 07340820981 | Ø40x10 | | 01/012 |



PC

TAMPA
lid fapa couvercle

| REF | (cm) | |
|------------|----------|--------|
| 0734080004 | Ø41x20.5 | 01/005 |



PP

CESTO REDONDO C/CÂMPANULA
basket with plate cover cesta con cubreplatos corbeille avec doche

| REF | (cm) | |
|-------------|------|--------|
| 04307229681 | Ø38 | 01/001 |



PP

CESTO REDONDO
basket cesta corbeille

| REF | (cm) | |
|-------------|----------|--------|
| 04307229682 | Ø35.5x10 | 01/010 |
| 04307229683 | Ø38x10 | 01/010 |



1



CÂMPANULA
plate cover cubreplatos cloche

| REF | (cm) | |
|-------------|------|--------|
| 04307229685 | Ø38 | 01/006 |
| 04307229684 | Ø38 | 01/006 |



2



PP

CESTO P/PÃO RECTANGULAR
bread basket cesta de pan corbeille à pain

| REF | (cm) | |
|-------------|-----------|--------|
| 0734083020 | 36.5x26x7 | 01/024 |
| 07340830201 | 36.5x26x7 | 01/024 |



PP

CESTO P/PÃO RECTANGULAR
bread basket cesta de pan corbeille à pain

| REF | (cm) | |
|-------------|---------|--------|
| 0734083036 | 30x22x9 | 01/024 |
| 07340830361 | 30x22x9 | 01/024 |
| 07340830362 | 30x22x9 | 01/024 |



PP

CESTO RECTANGULAR
basket cesta corbeille

| REF | (cm) | |
|-------------|---------|--------|
| 0734083042 | 27x10x5 | 01/060 |
| 07340830421 | 27x10x5 | 01/060 |



PP

CESTO RECTANGULAR
basket cesta corbeille

| REF | (cm) | |
|------------|-----------|--------|
| 0430724029 | 40x29x6.5 | 06/024 |
| 0732131021 | 40x30x6.5 | 01/030 |
| 0732131024 | 45x34x7 | 01/030 |



PP

GN
1/3

CESTO GN
basket cesta corbeille

| REF | (cm) | |
|------------|-------------|--------|
| 0732133217 | 32.5x17.5x8 | 01/005 |
| 0734088003 | 32.5x17.6x8 | 01/020 |



APRESENTAÇÃO

presentation presentación présentation

PP



CESTO P/PÃO RECTANGULAR
bread basket cesta de pan corbeille à pain

| REF | (cm) | |
|------------|---------|--------|
| 0734083429 | 35x25x8 | 01/024 |
| 0734083428 | 40x30x8 | 01/024 |
| 0734083394 | 46x35x8 | 01/024 |



PP



CESTO RECTANGULAR
basket cesta corbeille

| REF | (cm) | | |
|-------------|-----------|---|--------|
| 0734089010 | 41x28x8.5 | ■ | 01/020 |
| 07340890101 | 41x28x8.5 | ■ | 01/020 |
| 07340890102 | 41x28x8.5 | ■ | 01/020 |



PP

GN
1/2

CESTO GN
basket cesta corbeille

| REF | (cm) | | |
|-------------|-------------|---|--------|
| 07321332261 | 32.5x26.5x8 | ■ | 01/005 |
| 0732133226 | 32.5x26.5x8 | ■ | 01/005 |



PC

GN
1/2

CÂMPANULA GN
plate cover cubreplatos cloche

| REF | (cm) | |
|------------|------------|--------|
| 0732960379 | 33x27x13.2 | 01/012 |

PP

GN
1/1



CESTO
basket cesta corbeille

| REF | (cm) | | |
|-------------|-------------|---|--------|
| 0734089009 | 53x32.5x8.5 | ■ | 01/020 |
| 07340890091 | 53x32.5x8.5 | ■ | 01/020 |
| 07340890092 | 53x32.5x8.5 | ■ | 01/020 |



PP

GN
1/1

CESTO GN
basket cesta corbeille

| REF | (cm) | | |
|-------------|--------------|---|--------|
| 0734083069 | 52.5x32.5x10 | ■ | 01/020 |
| 07340830691 | 52.5x32.5x10 | ■ | 01/020 |
| 07340830692 | 52.5x32.5x10 | ■ | 01/020 |
| 0734083065 | 52.5x32.5x8 | ■ | 01/020 |
| 07340830651 | 52.5x32.5x8 | ■ | 01/020 |
| 07340830652 | 52.5x32.5x8 | ■ | 01/020 |



PP

GN
1/1

CESTO GN
basket cesta corbeille

| REF | (cm) | |
|------------|----------|--------|
| 0433900015 | 53x33x10 | 01/012 |





PP GN 1/1

CESTO GN
basket cesta corbeille

| REF | (cm) | |
|------------|-------------|--------|
| 0732131035 | 52.5x32.5x8 | 01/040 |



PP GN 1/1

CESTO GN
basket cesta corbeille

| REF | (cm) | | |
|-------------|-------------|--|--------|
| 07340830653 | 52.5x32.5x8 | | 01/020 |
| 07340830654 | 52.5x32.5x8 | | 01/020 |



PP

ARO P/GN
bread basket cesta de pan corbeille à pain

| REF | (cm) | | |
|-------------|---------|--------|--------|
| 0734080005 | 52x32x5 | GN 1/1 | 01/020 |
| 07340800051 | 52x32x5 | GN 1/1 | 01/020 |
| 07340800052 | 52x32x5 | GN 1/1 | 01/020 |
| 0734080006 | 31x25x5 | GN 1/2 | 01/020 |



PC GN 1/1

TAMPA DUPLA GN
lid tapa couvercle

| REF | (cm) | |
|-------------|----------|--------|
| 04339000014 | 53x33x18 | 01/006 |



PC GN 1/1

VITRINE GN
display vitrina vitrine

| REF | (cm) | |
|-------------|-----------|--------|
| 04339000013 | 53.5x32.5 | 01/006 |



PC GN 1/1

VITRINE GN
display vitrina vitrine

| REF | (cm) | |
|------------|---------|--------|
| 0732960380 | 53.5x33 | 01/006 |



APRESENTAÇÃO

presentation presentación présentation



PP

CESTO RECTANGULAR

basket cesta corbeille

| REF | (cm) | | |
|------------|------------|--|--------|
| 0734085253 | 45x30x11.5 | | 01/012 |
| 0734085436 | 40x30x10 | | 01/012 |



PP

CESTO RECTANGULAR

basket cesta corbeille

| REF | (cm) | | |
|------------|-------------|--|--------|
| 0734085316 | 60x28.5x4x9 | | 01/010 |
| 0734085317 | 30x28.5x4x9 | | 01/020 |



PP

CESTO RECTANGULAR

basket cesta corbeille

| REF | (cm) | | |
|------------|-------|--|--------|
| 0430724530 | 40x30 | | 12/024 |



PP

CESTO RECTANGULAR

basket cesta corbeille

| REF | (cm) | | |
|------------|-------------|--|--------|
| 0734085576 | 42x30x11x18 | | 01/014 |
| 0734085062 | 34x24x11x18 | | 01/012 |



PP

CESTO P/TALHER

cutlery basket cesta para cubiertos corbeille pour couvert

| REF | (cm) | | |
|-------------|------------|--|--------|
| 04307210182 | Ø12.5x15.5 | | 01/048 |
| 04307210184 | Ø12.5x15.5 | | 01/048 |



PP

CESTO QUADRADO

basket cesta corbeille

| REF | (cm) | | |
|-------------|----------|--|--------|
| 0734085422 | 16x16x14 | | 01/040 |
| 07340854221 | 16x16x14 | | 01/040 |



PP

CESTO QUADRADO

basket cesta corbeille

| REF | (cm) | | |
|-------------|---------|--|--------|
| 0734085521 | 16x16x8 | | 01/036 |
| 07340855211 | 16x16x8 | | 01/036 |



INOX

TENAZ P/SALADA

salad tong pinza ensaladera pince à salade

| REF | (cm) | | |
|------------|--------|--|--------|
| 0434070101 | 1 25 | | 01/120 |
| 0430680701 | 2 25.5 | | 12/120 |



INOX

TENAZ P/SALADA

salad tong pinza ensaladera pince à salade

| REF | (cm) | | |
|------------|------|--|--------|
| 0433653151 | 29.5 | | 01/100 |



INOX

TENAZ P/SALADA

salad tong pinza ensaladera pince à salade

| REF | (cm) | | |
|------------|--------|--|--------|
| 0433949904 | 22.5.3 | | 12/240 |
| 0434070994 | 25 | | 01/250 |



INOX

TENAZ P/BOLOS

cake tong pinza reposteria pince à gâteau

| REF | (cm) | |
|------------|------|--------|
| 0433949902 | 22.5 | 12/240 |
| 0434070992 | 25 | 00/000 |



INOX

TENAZ P/BOLOS

cake tong pinza reposteria pince à gâteau

| REF | (cm) | |
|------------|------|--------|
| 0430680110 | 24.7 | 12/096 |



INOX

TENAZ P/BOLOS

cake tong pinza reposteria pince à gâteau

| REF | (cm) | |
|-------------|------|--------|
| 04312600214 | 20 | 12/240 |



INOX

PINÇA P/TARTE

cake tong pinza reposteria pince à gâteau

| REF | (cm) | |
|-------------|------|--------|
| 04312600262 | 25.5 | 10/120 |



ACRÍLICO
ACRYLIC
ACRILICO
ACRYLIQUE

TENAZ P/SALADA

salad tong pinza ensaladera pince à salade

| REF | (cm) | |
|------------|------|--------|
| 0731252559 | 30 | 01/024 |



PC

PINÇA SERVIR

serving tong pinza servir pince à servir

| REF | (cm) | |
|-------------|------|--------|
| 0730260011 | 30 | 04/024 |
| 0730260010 | 23 | 48/192 |
| 0733610036 | 23 | 06/048 |
| 07302600091 | 15 | 06/048 |



PC

PINÇA SERVIR

serving tong pinza servir pince à servir

| REF | (cm) | |
|------------|------|--------|
| 0733638094 | 26.5 | 15/090 |



PC

COLHER SERVIR

spoon cuchara cuillère

| REF | (cm) | |
|-------------|------|--------|
| 07302600182 | 33 | 48/192 |
| 07302600161 | 28 | 48/192 |



PC

COLHER PERFURADA

spoon cuchara cuillère

| REF | (cm) | |
|-------------|------|--------|
| 07302600171 | 33 | 48/192 |
| 0730260017 | 33 | 48/192 |



PC

COLHER SERVIR

spoon cuchara cuillère

| REF | (cm) | |
|-------------|------|--------|
| 0732960719 | 26 | 01/160 |
| 07302600051 | 26 | 01/160 |



PORCELANA
PORCELAIN
PORCELANA
PORCELAINE

SUPORTE P/COLHER

spoon holder soporte para cuchara porte cuillère

| REF | (cm) | |
|------------|----------|--------|
| 0230767095 | 24x8x4.5 | 06/048 |



APRESENTAÇÃO

presentation presentación présentation



ESPÁTULA

spatula espátula spatule

| REF | (cm) | |
|------------|------|--------|
| 0733638132 | 25.5 | 10/100 |



CONJUNTO FACA+ESPÁTULA

kinfe+ spatula cuchillo + espátula couteau+ spatule

| REF | (cm) | |
|------------|------|-----------|
| 0731250021 | 29 | 25 01/072 |



GARFO P/APERITIVOS

appetizer fork
tenedor para aperitivos
fourchette mise en bouche

| REF | (cm) | |
|------------|------|--------|
| 0230531749 | 8.5 | 01/012 |

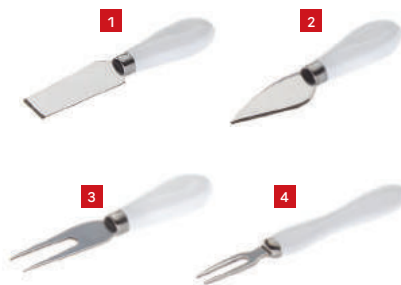

FACA P/QUEIJO

cheese knife cuchillo para queso couteau pour fromage

| REF | (cm) | |
|-------------|--------------|--------|
| 02305327422 | 13.7x2.5x1.7 | 01/006 |
| 02305327423 | 13.7x2.5x1.7 | 01/006 |

GARFO P/DEGUSTAÇÃO

tasting fork tenedor degustación fourchette pour dégouon

| REF | (cm) | |
|------------|------|--------|
| 0230531539 | 11.5 | 01/012 |

GARFO P/QUEIJO

cheese fork tenedor para queso fourchette pour fromage

| REF | (cm) | |
|-------------|--------------|--------|
| 02305327424 | 13.7x2.5x1.7 | 01/006 |



BARCO P/SUSHI

sushi boat barco para sushi bateau pour sushi

| REF | (cm) | |
|------------|------|--------|
| 1133710150 | 50 | 01/010 |



TÁBUA P/PÃO

breadboard tabla para pan planche pour pain

| REF | (cm) | |
|------------|---------|--------|
| 1133710046 | 38x25x2 | 01/010 |



TÁBUA P/APRESENTAÇÃO

display plate soporte presentación présentoir

| REF | (cm) | |
|------------|---------|-----------------|
| 1133711030 | 40x30x1 | 01/012 |
| 0230767516 | 40x30x1 | NOVO new 04/024 |



BASES

round base salvamantale dessous de plats

| REF | (cm) | |
|------------|-------|--------|
| 1133710029 | Ø17.5 | 01/100 |



BASES

round base salvamantale dessous de plats

| REF | (cm) | |
|------------|-------|--------|
| 1133710045 | 18x18 | 01/100 |



PRATO RECTANGULAR

rectangular plate plato rectangular assiette rectangulaire

| REF | (cm) | |
|------------|----------|--------|
| 1133710014 | 12x6 | 01/020 |
| 1133710016 | 17.7x5.8 | 01/020 |



PC

SUPORTE P/TALHER
cutlery holder contenedor de cubiertos panier à couverts

| REF | (cm) | |
|------------|------------|--------|
| 0730834143 | 16.5x18x15 | 01/021 |

ACRÍLICO
ACRYLIC
ACRILICO
ACRYLIQUE

PC

SUPORTE P/TALHER
cutlery holder contenedor de cubiertos panier à couverts

| REF | (cm) | |
|------------|--------------|--------|
| 0730836442 | 27x14.5x28.5 | 01/012 |



INOX

PORTA TALHERES
cutlery holder contenedor de cubiertos panier à couverts

| REF | (cm) | |
|------------|--------------|--------|
| 0433494604 | 26.5x30.5x20 | 01/008 |



ACRÍLICO
ACRYLIC
ACRILICO
ACRYLIQUE

TABULEIRO P/TALHERES
cutlery holder contenedor de cubiertos panier à couverts

| REF | (cm) | |
|------------|--------------|--------|
| 0731252631 | 45.5x29.5x11 | 01/003 |



INOX

PORTA TALHERES
cutlery holder contenedor de cubiertos panier à couverts

| REF | (cm) | |
|------------|------------|--------|
| 0432790221 | Ø12.7x14.9 | 04/036 |



INOX

PORTA TALHERES
cutlery holder contenedor de cubiertos panier à couverts

| REF | (cm) | |
|------------|---------|--------|
| 0434070033 | Ø9x16.3 | 01/072 |



INOX

PORTA TALHERES
cutlery holder contenedor de cubiertos panier à couverts

| REF | (cm) | |
|------------|------------|--------|
| 0433655111 | Ø11.5x13.5 | 01/072 |



INOX

PORTA TALHERES
cutlery holder contenedor de cubiertos panier à couverts

| REF | (cm) | |
|-------------|---------|--------|
| 04312690031 | Ø9.5x13 | 01/012 |



APRESENTAÇÃO

presentation presentación présentation



buffet buffet buffet buffet



JARRO C/TUBO REFRIGERADOR

jug with refrigerator tube
jarro con enfriador
carafe avec refroidisseur

| REF | (cm) | LT | |
|------------|------|----|-----------|
| 0733800014 | 1 | 27 | 3* 01/012 |

*sem refrigerador e infusor
without refrigerator and diffuser
sin enfriador y difusor
sans refroidisseur et diffuseur

TUBO DIFUSOR

diffuser tube difusor diffuseur

| REF | (cm) | |
|------------|------|-----------|
| 0733800016 | 2 | 22 01/020 |

TAMPA C/TUBO REFRIGERADOR

jcouver with refrigerator tube
tapa con enfriador
couvercle avec refroidisseur

| REF | (cm) | |
|------------|------|-----------|
| 0733800022 | 3 | 22 01/012 |

Os tubos refrigerador e difusor permitem re-frescar e aromatizar as bebidas, através do enchimento dos mesmos com cubos de gelo e pedaços de fruta.

The refrigerator and diffuser tubes allow you to re-fresh and aromatize the drinks by filling them with ice cubes and fruit pieces.

Los tubos del enfriador y el difusor permiten frías y bebidas saborizantes, llenando la misma con cubitos de hielo y trozos de fruta.

Les tubes du refroidisseur et diffuseur permettent boissons fraîches et aromatisants en remplissant la même chose avec des cubes de glace et des morceaux de fruits.



JARRO C/TUBO REFRIGERADOR E INFUSOR

cooler jug with refrigerator and infuser tube
jarro con enfriador y infusor
carafe avec refroidisseur et infuseur

| REF | (cm) | LT | |
|-------------|------|------|--------|
| 07312500041 | 26.5 | 2.9* | 01/006 |

*sem refrigerador
without refrigerator
sin enfriador
sans refroidisseur



JARRO C/TUBO DIFUSOR

jug with diffuser tube jarro con difusor carafe avec diffuseur

| REF | (cm) | LT | |
|------------|------|-----|--------|
| 0734040011 | 23.5 | 2.8 | 01/008 |



JARRO C/TUBO INFUSOR

jug with infuser tube jarro con infusor carafe avec infuseur

| REF | (cm) | LT | |
|-------------|------|------|--------|
| 07312500044 | 21.3 | 3.5* | 01/006 |

*sem refrigerador without refrigerator
sin enfriador sans refroidisseur



JARRO C/TUBO REFRIGERADOR

jug with refrigerator tube
jarro con enfriador carafe avec refroidisseur

| REF | (cm) | LT | |
|------------|------|------|--------|
| 0430946995 | 26 | 1.68 | 01/006 |



JARRO C/TAMPA
jug with lid jarro con tapa carafe avec couvercle

| REF | (cm) | LT | |
|------------|------|-----|--------|
| 0430946271 | 28 | 1.7 | 01/006 |



JARRO C/TAMPA
jug with lid jarro con tapa carafe avec couvercle

| REF | (cm) | LT | |
|------------|------|-----|--------|
| 0730260610 | 23.5 | 1.9 | 01/024 |



JARRO C/TAMPA
jug with lid jarro con tapa carafe avec couvercle

| REF | (cm) | LT | |
|------------|------|----|--------|
| 0733638529 | 23.5 | 22 | 01/024 |



JARRO C/TAMPA
jug with lid jarro con tapa carafe avec couvercle

| REF | (cm) | LT | |
|------------|------|-----|--------|
| 0430940359 | 25 | 2.9 | 01/006 |



GARRAFA REFRIGERADORA
cooler bottle botella refrigerante bouteille rafraichisseur

| REF | (cm) | LT | |
|------------|------|-----|--------|
| 0731250800 | 30 | 0.8 | 01/012 |

+ JARROS
jugs
jarros
pichets
pg. 174-176



+ JARROS
jugs
jarros
pichets
pg. 271



buffet buffet buffet buffet



DISPENSADOR P/LÍQUIDOS
liquid dispenser dispensador para líquidos
distributeurs pour liquides

| REF | (cm) | LT | |
|------------|------|----|--------|
| 0330753321 | 42.5 | 12 | 01/002 |



DISPENSADOR P/LÍQUIDOS
liquid dispenser dispensador para líquidos
distributeurs pour liquides

| REF | (cm) | LT | |
|-------------|------|----|--------|
| 03307533211 | 24 | 6 | 01/006 |



SUPORTE
support suporte support

| REF | (cm) | |
|------------|----------|--------|
| 0330753302 | 16x16x19 | 01/025 |



DISPENSADOR P/LÍQUIDOS
liquid dispenser dispensador para líquidos
distributeurs pour liquides

| REF | (cm) | LT | |
|------------|----------|----|--------|
| 0332445121 | Ø17.5x30 | 5 | 01/004 |

balde de metal metal bucket
cubo de metal seuu métallique Ø22x18



DISPENSADOR P/LÍQUIDOS
liquid dispenser dispensador para líquidos
distributeurs pour liquides

| REF | (cm) | LT | |
|------------|----------|----|--------|
| 0332445120 | 18x18x32 | 8 | 01/004 |





APRESENTAÇÃO

presentation presentación présentation



DISPENSADOR P/LÍQUIDOS
liquid dispenser dispensador para líquidos
distributeurs pour liquides

| REF | (cm) | LT | |
|------------|------------|----|--------|
| 0333796016 | 16x16x28.2 | 5 | 01/002 |



DISPENSADOR P/LÍQUIDOS
liquid dispenser dispensador para líquidos
distributeurs pour liquides

| REF | (cm) | LT | |
|------------|----------|-----|--------|
| 0333796146 | Ø21x29.5 | 7.9 | 01/002 |



DISPENSADOR SUMO
juice dispenser dispensador jugo distributeur jus

| REF | (cm) | LT | |
|-------------|------------|----|--------|
| 04339000121 | 35x30x49.4 | 12 | 01/001 |



DISPENSADOR SUMO TRIPLO
juice dispenser dispensador jugo distributeur jus

| REF | (cm) | LT | |
|-------------|----------|----------|--------|
| 04339000041 | 31x26x71 | 3.5 (x3) | 01/001 |



DISPENSADOR SUMO
juice dispenser dispensador jugo distributeur jus

| REF | (cm) | LT | |
|------------|----------|----|--------|
| 0432610512 | 26x35x55 | 8 | 01/001 |



DISPENSADOR SUMO
juice dispenser dispensador jugo distributeur jus

| REF | (cm) | LT | |
|------------|--------------|----|--------|
| 0433900006 | 31.5x21.5x55 | 6 | 01/001 |

MODELO model modelo modèle **EJDR6A**
VOLTAGEM voltage voltaje voltage **220V**
FREQUÊNCIA frequency frecuencia fréquence **50HZ**
POTÊNCIA power potencia puissance **90W**

COM REFRIGERADOR WITH REFRIGERATOR
CON ENFRIADO AVEC RÉFRIGÉRATEUR



DISPENSADOR SUMO
juice dispenser dispensador jugo distributeur jus

| REF | (cm) | LT | |
|------------|--------|----|--------|
| 0432610212 | Ø18x36 | 9 | 01/001 |

base inox 35x22.5x20
 stainless steel base 35x22.5x20
 base de acero inoxidable 35x22.5x20
 base en acier inoxydable 35x22.5x20



DISPENSADOR SUMO
juice dispenser dispensador jugo distributeur jus

| REF | (cm) | LT | |
|------------|--------|----|--------|
| 0430682045 | Ø12x33 | 3 | 01/001 |

base inox 30x18.5x20
 stainless steel base 30x18.5x20
 base de acero inoxidable 30x18.5x20
 base en acier inoxydable 30x18.5x20



DISPENSADOR LEITE
milk dispenser dispensador leche distributeur lait

| REF | (cm) | LT | |
|------------|----------|----|--------|
| 0430682019 | Ø20.5x30 | 8 | 01/001 |

base inox 35.5x25x26
 stainless steel base 35.5x25x26
 base de acero inoxidable 35.5x25x26
 base en acier inoxydable 35.5x25x26



DISPENSADOR CAFÉ

coffee dispenser dispensador de café distributeur de café

| REF | (cm) | LT | |
|------------|----------|----|--------|
| 0433900013 | 32x33x56 | 13 | 01/001 |

com lamparina with oil lamp con lucecita avec lamp



PONCHEIRA C/CONCHA

punch bowl with ladle ponchera con cucharón
bol à punch avec louche

| REF | (cm) | LT | |
|------------|--------|----|--------|
| 0333796275 | Ø19x26 | 5 | 01/002 |



FRAPPÉ

wine cooler frappé manchon bouteille

| REF | (cm) | |
|------------|----------|--------|
| 0431112126 | Ø15.5x26 | 01/004 |



FRAPPÉ REFRIGERANTE

wine cooler frappé manchon bouteille

| REF | (cm) | |
|------------|--------|--------|
| 0430943669 | Ø10x19 | 01/012 |



MANGA REFRIGERADORA

cooler sleeve manga refrigerante manchon réfrigérant

| REF | (cm) | |
|-------------|------|-----------------|
| 0432273104 | 1 | 32.5x18 25/050 |
| 0432273026 | 2 | 33.x2x18 01/028 |
| 04322700013 | 3 | 37.5x23 14/028 |
| 0432270001 | 4 | 37.5x23 00/025 |



MANGA REFRIGERADORA C/IMPRESSÃO

cooler sleeve manga refrigerante manchon réfrigérant

| REF | (cm) | |
|------------|------|--------|
| 0432270300 | 18 | 00/036 |



FRAPPÉ TÉRMICO

thermos bucket balde térmico manchon thermique

| REF | (cm) | |
|------------|----------|--------|
| 0731250009 | Ø12.3x28 | 01/006 |
| 0731250901 | Ø11.5x23 | 01/006 |



FRAPPÉ FOSCO

mate wine cooler frappé opaco manchon bouteille mat

| REF | (cm) | |
|------------|----------|--------|
| 0730260501 | Ø11.5x23 | 01/012 |



CONCHA

ladle cacillo louche

| REF | (cm) | CL | |
|------------|------|-------|-----------|
| 0731250008 | 1 | Ø9x31 | 10 01/024 |
| 0430943423 | 2 | Ø8x30 | 10 01/072 |



CONCHA

ladle cacillo louche

| REF | (cm) | CL | |
|------------|------|----|--------|
| 0430720092 | 24.5 | 9 | 01/002 |

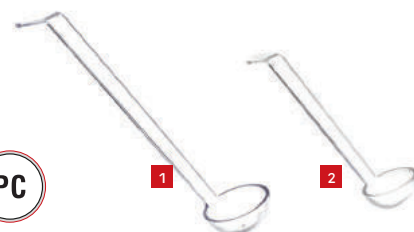

CONCHA

ladle cacillo louche

| REF | (cm) | CL | |
|-------------|------|---------|------------|
| 07302600131 | 1 | Ø6x27 | 3.5 48/192 |
| 0733638139 | 2 | Ø5.5x21 | 2.8 24/144 |



APRESENTAÇÃO

presentation presentación présentation



FINGER FOOD

finger food finger food finger food



É uma nova tendência gourmet, prática e sofisticada para apresentar e servir aperitivos em diversos tipos de eventos.

Utilizados para servir pequenas porções de comida de forma simples e elegante, permitem saborear a comida sem utilizar talheres e também uma maior interação.

It is a new gourmet trend, practical and sophisticated to present and serve appetizers in various types of events.

Used to serve small portions of food in a simple and elegant way, they allow you to taste the food without using cutlery and also a greater interaction.

Se trata de una nueva tendencia gourmet, práctico y sofisticado para presentar y servir aperitivos en diversos tipos eventos.

Se utiliza para servir porciones pequeñas de comida sencilla y elegante, para saborear la comida sin usar los cubiertos y también una mayor interacción.

C'est une nouvelle tendance gourmet, pratique et sophistiquée pour présenter et servir des apéritifs lors de divers types événements.

Utilisé pour servir de petites portions de nourriture d'une façon simple et élégante, permet de savourer les aliments sans utiliser des couverts et aussi meilleure interaction.

buffet buffet buffet buffet

PACK 16
PS



MINI COLHER GOTTA
mini drop spoon cuchara en gota mini cuillère en goutte

| REF | (cm) | CL | |
|------------|------|-----|--------|
| 0732783282 | 10.5 | 2.7 | 01/024 |

PACK 12
PS



MINI TRAVESSA RECTANGULAR
mini tray mini fuente mini plateau

| REF | (cm) | CL | |
|------------|---------|----|--------|
| 0732785777 | 8x5.5x1 | 3 | 01/024 |

PACK 10
PS



MINI PRATO ONDULADO
mini plate mini plato mini assiette

| REF | (cm) | |
|------------|---------|--------|
| 0732783280 | 7.5x7.5 | 01/024 |

PACK 8
PS



TUBO QUADRADO
squared tube tubo cuadrado ból carré

| REF | (cm) | CL | |
|------------|---------|-----|--------|
| 0732783284 | 4x4x8.2 | 8.6 | 01/024 |

PACK 12
PS



COPO ONDULADO ALTO
high glass vaso alto verre haut

| REF | (cm) | CL | |
|------------|---------|-----|--------|
| 0732787848 | 5.3x8.4 | 6.8 | 01/024 |

PACK 12
PS



MINI TUBO
mini tube mini tubo mini tube

| REF | (cm) | CL | |
|------------|--------|----|--------|
| 0732783202 | Ø4x8.4 | 7 | 01/024 |

PACK 12
PS



MINI COPO CÔNICO
mini glass mini vaso mini verre

| REF | (cm) | CL | |
|------------|----------|-----|--------|
| 0732783203 | Ø4.7x7.5 | 7.2 | 01/024 |

PACK 12
PS



MINI COPO C/PÉ
mini glass mini vaso mini verre

| REF | (cm) | CL | |
|------------|---------|----|--------|
| 0732787851 | 5x5x5.5 | 6 | 01/024 |

PACK 12
PS



MINI COPO C/PÉ
mini glass mini vaso mini verre

| REF | (cm) | CL | |
|------------|-------------|----|--------|
| 0732783204 | 4.5x4.5x5.3 | 8 | 01/024 |

PACK 12
PS



MINI TAÇA
mini bowl mini vaso mini ból

| REF | (cm) | CL | |
|------------|-------------|-----|--------|
| 0732783205 | 5.6x5.6x3.5 | 6.2 | 01/048 |

PACK 12
PS



MINI CUBO DIAMANTE
mini cube diamond mini cubo diamante mini cube diamant

| REF | (cm) | CL | |
|------------|-----------|-----|--------|
| 0732787840 | 5.3x3x5.7 | 7.4 | 01/024 |

PACK 12
PS



MINI COPO QUADRADO
mini glass mini vaso mini verre

| REF | (cm) | CL | |
|-------------|-------------|-----|--------|
| 07327832811 | 4.9x2.9x4.5 | 6.3 | 01/024 |
| 07327832812 | 4.9x2.9x4.5 | 6.3 | 01/024 |

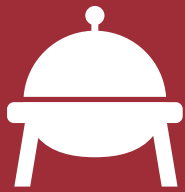

CHAFING DISH

chafing dish chafing dish chafing dish





CHAFING DISH

chafing dish chafing dish chafing dish



CHAFING DISH

chafing dish chafing dish chafing dish

| REF | (cm) | LT | |
|------------|--------------|----|--------|
| 0433902301 | 63.5x42.5x44 | 9 | 00/001 |



CHAFING DISH

chafing dish chafing dish chafing dish

| REF | (cm) | LT | |
|------------|--------------|----|--------|
| 0433900231 | 63.5x44x43.5 | 9 | 00/001 |



CHAFING DISH

chafing dish chafing dish chafing dish

| REF | (cm) | LT | |
|-------------|------------|----|--------|
| 04338900481 | 64x43.5x44 | 9 | 01/050 |



CHAFING DISH

chafing dish chafing dish chafing dish

| REF | (cm) | LT | |
|------------|----------------|------|--------|
| 0432611611 | 53.5x33.5x16.5 | 15.8 | 00/001 |

Os Chafing Dish estão preparados para ter lamparinas por baixo, no entanto este contém parafusos que permitem a adaptação para resistência eléctrica.

Chafing Dish are prepared for oil lamps, however this contains screws that enable the adaptation of electric resistance.

Chafing Dish están preparados para tener lamparitas debajo, sin embargo éste contiene algunos tornillos que permiten la adaptación para resistencia eléctrica.

Le chafing dish sont préparés pour avoir des lampes au-dessous, mais il contient des vis qui permettent l'adaptation à la résistance électrique.



GN
1/1

TAMPA BASCULANTE

cover tapa couvercle

| REF | (cm) | |
|-------------|----------------|--------|
| 04326116111 | 63.5x33.5x16.5 | 00/003 |



CHAFING DISH

chafing dish chafing dish chafing dish

| REF | (cm) | LT | |
|------------|------------|----|--------|
| 0432610631 | 60x36.7x31 | 9 | 00/001 |

material: aço 201 | com suporte para resistência
material: steel 201 | with resistance stand
material: acero 201 | con soporte para resistencia
matière: acier 201 | avec support pour résistance



CHAFING DISH

chafing dish chafing dish chafing dish

| REF | (cm) | LT | |
|------------|----------|----|--------|
| 0433988331 | 56x36x31 | 9 | 00/001 |



CHAFING DISH

chafing dish chafing dish chafing dish

| REF | (cm) | |
|------------|------------|--------|
| 1332100100 | 56.5x36x32 | 00/001 |

MODELO model modelo modèle ZCK100S
CAPACIDADE capacity capacidad capacité 13.5L
VOLTAGEM voltage voltaje voltage 220V
FREQUÊNCIA frequency frecuencia fréquence 50HZ
POTÊNCIA power potencia puissance 1.6KW



CHAFING DISH

chafing dish chafing dish chafing dish

| REF | (cm) | |
|------------|----------|--------|
| 1332100806 | 65x38x26 | 00/001 |

MODELO model modelo modèle **ZC806BM-65P**
CAPACIDADE capacity capacidad capacité **13.5L**
VOLTAGEM voltage voltaje voltage **220V**
FREQUÊNCIA frequency frecuencia fréquence **50HZ**
POTÊNCIA power potencia puissance **0.90KW**



CHAFING DISH

chafing dish chafing dish chafing dish

| REF | (cm) | |
|------------|----------|--------|
| 0430681302 | 65x45x37 | 00/001 |

GN1/1 porcelana porcelain GN1/1
 GN1/1 porcelana GN1/1 porcelaine

MODELO model modelo modèle **A11302**
CAPACIDADE capacity capacidad capacité **9L**
VOLTAGEM voltage voltaje voltage **220V**
POTÊNCIA power potencia puissance **2.5KW**

elegância,
apresentação,
e conservação

elegance,
presentation,
and conservation

elegancia,
presentación,
y conservación

élégance
présentation,
et conservation



a campânula abre em 180° - Ø39cm quando se toca na pega a tampa abre automaticamente em 30° de abertura a tampa mantém-se aberta em qualquer ângulo, fecha automaticamente

the bell opens at 180° - diameter 39cm when the handle is touched the cover automatically opens at 30° opening the lid stays open at any angle, closes automatically

la capota se abre 180° - 39 cm de diâmetro al tocar la manija de la tapa se abre automáticamente en la abertura 30° la tapa se mantiene abierta en cualquier ángulo, se cierra automáticamente

le capot s'ouvre à 180° - 39cm de diamètre Lorsque vous appuyez sur la poignée le couvercle s'ouvre automatiquement à 30°. Le couvercle se maintient ouvert en quelque ouverture et se ferme automatiquement.



CHAFING DISH

chafing dish chafing dish chafing dish

| REF | (cm) | LT | |
|------------|------|----------|----------|
| 0432610663 | 1 | Ø52x46 | 5 00/001 |
| 0432611363 | 2 | 54x51x48 | 5 00/001 |



TABULEIRO REDONDO P/CHAFING DISH

roaster rustidera plat à foïtir

| REF | (cm) | |
|-------------|---------|--------|
| 04326106631 | Ø39x6.5 | 01/020 |



CHAFING DISH

chafing dish chafing dish chafing dish

| REF | (cm) | LT | |
|------------|----------|-----|--------|
| 0433908311 | Ø34x27.5 | 3.5 | 01/001 |



TABULEIRO REDONDO P/CHAFING DISH

roaster rustidera plat à foïtir

| REF | (cm) | |
|-------------|-------|--------|
| 04339083111 | Ø34x6 | 01/040 |



CHAFING DISH

chafing dish chafing dish chafing dish



CHAFING DISH

chafing dish chafing dish chafing dish

| REF | (cm) | LT | |
|------------|----------|------|--------|
| 0733610025 | Ø33.5x41 | 13.5 | 01/001 |



CHAFING DISH

chafing dish chafing dish chafing dish

| REF | (cm) | LT | |
|------------|--------|-----|--------|
| 0432439999 | Ø30x24 | 4.5 | 01/001 |



PANELA P/SOPA C/LAMPARINA

soup kettle olla para sopa soupière

| REF | (cm) | LT | |
|------------|--------|----|--------|
| 0437360003 | Ø32x40 | 10 | 01/001 |

dupla funcionalidade

dual functionality
doble funcionalidad
double fonctionnalité



PANELA P/SOPA

soup kettle olla para sopa soupière

| REF | (cm) | LT | |
|------------|-----------|----|--------|
| 0432612288 | Ø46x42x47 | 10 | 00/001 |

para indução
com suporte para lamparina
tampa com descida amortecida que fecha suavemente
com vidro na tampa para facilitar a visualização
as gotas de condensação regressam à couvete de água
separável base e corpo

for induction
with lamp holder
soft cushioned cover that closes gently
with glass on the cover for easy viewing
the condensation drops return to the water cuvet
separable base and body

para la inducción
con soporte para la lámpara
cubrir con el descenso amortiguado cierra sin problemas
el vidrio de cubierta para una fácil visualización
las gotas de agua de condensación que regresan a cubeta
base desmontable y el cuerpo

pour l'induction
avec le support de lampe
couvrir avec descente amortie se ferme en douceur
le verre de couverture pour faciliter la visualisation
les gouttes d'eau de condensation retour à cuve
base et le corps détachable





PANELA ELÉCTRICA P/SOPA

electric soup kettle olla eléctrica para sopa eletrique soupière

| REF | (cm) | LT | |
|------------|----------|----|--------|
| 0432611388 | Ø31x32.5 | 9 | 00/001 |

MODELO model modelo modèle AT51388

VOLTAGEM voltage voltaje voltage 220V

FREQUÊNCIA frequency frecuencia fréquence 50HZ

POTÊNCIA power potencia puissance 0.80KW



PANELA ELÉCTRICA P/SOPA

electric soup kettle olla eléctrica para sopa eletrique soupière

| REF | (cm) | LT | |
|------------|--------|----|--------|
| 0432106000 | Ø36x35 | 10 | 00/001 |

MODELO model modelo modèle AT51588

VOLTAGEM voltage voltaje voltage 230V

FREQUÊNCIA frequency frecuencia fréquence 50HZ

POTÊNCIA power potencia puissance 400W



TAMPA P/PANELA

lid tapa couvercle

| REF | (cm) | |
|------------|-------|--------|
| 0432610062 | Ø24.2 | 01/024 |



CUBA

vat fina cuve

| REF | (cm) | LT | |
|------------|------------|----|--------|
| 0432610064 | Ø24.3x23.2 | 10 | 01/006 |



CUBA

vat fina cuve

| REF | (cm) | LT | |
|------------|--------|----|--------|
| 0432610061 | Ø30x20 | 9 | 01/001 |



BANHO MARIA

bain marie baño maria bain-marie

| REF | (cm) | LT | |
|------------|----------|----|--------|
| 0432100165 | 55x35x54 | 24 | 00/001 |

MODELO model modelo modèle ZCK165AT-1

VOLTAGEM voltage voltaje voltage 220V

FREQUÊNCIA frequency frecuencia fréquence 50HZ

POTÊNCIA power potencia puissance 1.20KW



BANHO MARIA

bain marie baño maria bain-marie

| REF | (cm) | LT | |
|------------|--------------|-----|--------|
| 1332380004 | 32.5x26.5x29 | 4.5 | 01/012 |

MODELO model modelo modèle TTB-4

VOLTAGEM voltage voltaje voltage 220/240V

FREQUÊNCIA frequency frecuencia fréquence 50/60HZ

POTÊNCIA power potencia puissance 850W

para sopas e molhos for soups and sauces

para sopas y salsas pour soups et les sauces



TAMPA BASCULANTE

lid tapa couvercle

| REF | (cm) | |
|------------|---------|--------|
| 0430689111 | Ø30x3.5 | 06/024 |



GN 1/1

PLACA AQUECEDORA

warming plate placa de calentamiento plaque de chauffage

| REF | (cm) | |
|-------------|-----------|--------|
| 13323800013 | 53.5x35x8 | 01/080 |



PLACA ARREFECIMENTO

cooling plate placa enfriadora plaque réfrigérante

| REF | (cm) | |
|------------|---------------|---------------|
| 0433902801 | 53x32.5x4.5 | GN 1/1 01/005 |
| 0433902803 | 32.5x17.6x4.5 | GN 1/2 01/004 |



PLACA ARREFECIMENTO

cooling plate placa enfriadora plaque réfrigérante

| REF | (cm) | |
|------------|-------------|--------|
| 1331080101 | 32.5x26.5x5 | 01/006 |





CHAFING DISH

chafing dish chafing dish chafing dish



PLACA ELÉCTRICA

electric plate placa eléctrica plaque électrique

| REF | (cm) | |
|------------|-------|--------|
| 0430681802 | 25x20 | 00/001 |

MODELO model modelo modèle **A11802**
VOLTAGEM voltage voltaje voltage **230V**
FREQUÊNCIA frequency frecuencia fréquence **60HZ**
POTÊNCIA power potencia puissance **0.7KW**



BANHO MARIA

bain marie baño maría bain-marie

| REF | (cm) | LT | |
|------------|---------|-----|--------|
| 0432610205 | 20x18.5 | 4.5 | 01/001 |

MODELO model modelo modèle **DB-205**
VOLTAGEM voltage voltaje voltage **230V**
FREQUÊNCIA frequency frecuencia fréquence **60HZ**
POTÊNCIA power potencia puissance **0.28KW**



PLACA ELÉCTRICA C/TERMOSTATO

electric plate with thermostat
placa eléctrica con termostato
plaque électrique avec thermostat

| REF | (cm) | |
|------------|---------|--------|
| 0432610405 | Ø10.8x9 | 01/010 |

*altura ajustável: 9-11 *adjustable height: 9-11
 *regulable en altura:9-11 *réglable en hauteur:9-11



LAMPARINA P/GEL COMBUSTÍVEL

burner holder lâmpara para combustível brûler

| REF | (cm) | |
|------------|--------|--------|
| 0433900016 | Ø9x5.5 | 01/180 |



LAMPARINA P/GEL COMBUSTÍVEL

spoon holder salsera chafong dish saucière chafing dish

| REF | (cm) | |
|-------------|--------|--------|
| 04322700011 | Ø9x3.5 | 01/100 |



SUPORE COLHER

spoon holder salsera chafong dish saucière chafing dish

| REF | (cm) | |
|-------------|---------|--------|
| 04312600026 | 24x10x6 | 01/072 |



SUPORE COLHER

spoon holder salsera chafong dish saucière chafing dish

| REF | (cm) | |
|------------|-----------|--------|
| 0430681953 | 22x11x3.5 | 01/020 |



SUPORE COLHER

spoon holder salsera chafong dish saucière chafing dish

| REF | (cm) | |
|------------|-----------|--------|
| 0430681951 | 28x14x2.3 | 12/048 |



áreas de uso:

chafing dish/banho maria
barbecues
aquecedores exteriores
aquecedores de pés

areas of use:

chafing dish/bain marie
barbecues
outdoor heaters
foot heaters

campos de aplicación:

chafing dish/baño maría
barbaçoas
calentadores al aire libre
calentadores de pies

domaines d'utilisation:

chafing dish/bain-marie
barbecues
chauffage extérieur
chauffe-pieds



GEL COMBUSTÍVEL METANOL

methanol fuel
gel combustible metanol
gel combustible méthanol

| REF | KG | | |
|------------|----------|---|--------|
| 0437360009 | 4KG/4.7L | 1 | 01/004 |
| 0437360010 | 235GR | 2 | 01/072 |

GEL COMBUSTÍVEL ETANOL

ethanol fuel gel combustible etanol gel combustible éthanol

| REF | KG | | |
|------------|----------|---|--------|
| 0437360011 | 4KG/4.7L | 3 | 01/004 |
| 0437360012 | 250GR | 4 | 01/072 |



LÂMPADAS DE AQUECIMENTO

heat lamp
lâmpara de calentamiento
lampe de chauffage

As lâmpadas de aquecimento são ideais para utilizar no serviço de buffet e catering de modo a manter os alimentos quentes.

The heat lamps are ideal for use in catering and catering in order to keep food warm.

Las lámparas de calefacción son ideales para utilizar en el servicio de buffet y catering para mantener los alimentos calientes.

Les lampes chauffantes sont idéales pour la restauration et la restauration afin de garder les aliments au chaud.



NOVO
new

AQUECEDOR DE ALIMENTOS DUPLO
heating lamp lâmpara de calentamiento lampe de chauffage

| REF | (cm) | |
|--|-------------------|--------|
| 1332385501 | 49x34.5x55.5-70.5 | 01/001 |
| POTÊNCIA power potencia puissance 275W | | |



NOVO
new

AQUECEDOR DE ALIMENTOS DUPLO
heating lamp lâmpara de calentamiento lampe de chauffage

| REF | (cm) | |
|--|-------------------|--------|
| 1332385502 | 51x35.5x59.5-74.5 | 01/001 |
| POTÊNCIA power potencia puissance 275W | | |



NOVO
new

AQUECEDOR DE ALIMENTOS RETRÁCTIL
heating lamp lâmpara de calentamiento lampe de chauffage

| REF | (cm) | |
|--|----------|--------|
| 13323800019 | 22x40-85 | 01/001 |
| POTÊNCIA power potencia puissance 250W | | |



NOVO
new

AQUEC. ALIMENTOS RETRÁCTIL "ANTIQUE"
heating lamp lâmpara de calentamiento lampe de chauffage

| REF | (cm) | |
|--|------------|--------|
| 0433901506 | Ø29x60-150 | 01/001 |
| POTÊNCIA power potencia puissance 250W | | |



AQUECEDOR DE ALIMENTOS RETRÁCTIL
heating lamp lâmpara de calentamiento lampe de chauffage

| REF | (cm) | |
|--|------------|--------|
| 04339023011 | Ø25x60-150 | 01/001 |
| POTÊNCIA power potencia puissance 250W | | |



AQUECEDOR DE ALIMENTOS RETRÁCTIL
heating lamp lâmpara de calentamiento lampe de chauffage

| REF | (cm) | |
|--|------------|--------|
| 0433901302 | Ø27x60-150 | 01/001 |
| POTÊNCIA power potencia puissance 250W | | |



AQUECEDOR DE ALIMENTOS RETRÁCTIL
heating lamp lâmpara de calentamiento lampe de chauffage

| REF | (cm) | |
|--|------------|--------|
| 0433901306 | Ø27x60-150 | 01/001 |
| POTÊNCIA power potencia puissance 250W | | |



LÂMPADA PARA SUBSTITUIÇÃO
replacement lamp lâmpara de repuesto lampe de rechange

| REF | (cm) | |
|--|------|--------|
| 04339023012 | - | 01/001 |
| POTÊNCIA power potencia puissance 250W | | |



TRANSPORTE/ARMAZENAMENTO

transport/storage

transporte/almacenamiento

transport/stockage

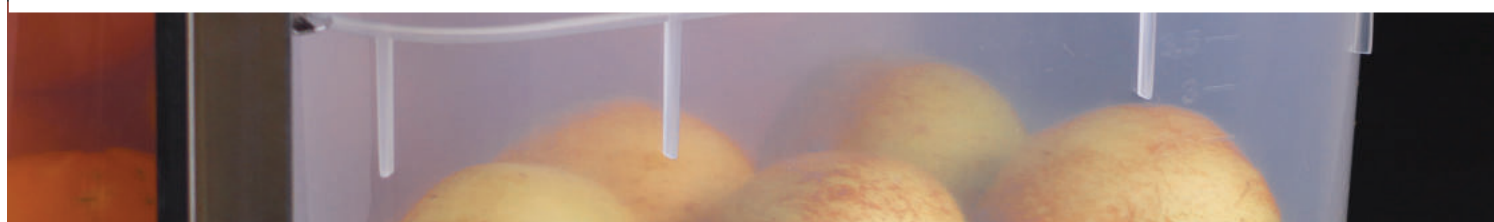



CONTENTORES GASTRONÓMICOS

gastronomisc containers

contenedores gstronómicos

bacs gastronomiques



Os contentores padrão GN ou Gastronorm são recipientes com dimensões universais segundo a norma europeia EN-631, que estabelece quais os materiais e artigos que podem entrar em contacto com os alimentos e as medidas para os recipientes utilizados nos serviços de manipulação, conservação e distribuição de alimentos.

A utilização nas cozinhas profissionais, proporciona grandes benefícios na preparação e confecção dos alimentos, devido a um melhor e maior aproveitamento do espaço na cozinha, à redução da necessidade de troca dos ingredientes para os recipientes, diminuição ou perda de desperdício de alimentos, facilidade na higienização e melhoramento a nível de segurança alimentar.

Os contentores GN, possuem uma dimensão padrão de comprimento e largura de 530x325mm, estabelecida mundialmente como 1/1. Sempre com base no padrão 1/1, há contentores múltiplos (2/1) e submúltiplos (1/2, 1/3, 1/4, 1/6, etc), possibilitando composições personalizadas dentro do espaço 1/1.

A profundidade do contentor padrão GN pode variar de fabricante para fabricante, podendo ir de 20 a 200 mm.

Para maior resistência a baixas/altas temperaturas, facilidade de transporte, durabilidade e higienização, os materiais mais comuns utilizados são o aço inox e o policarbonato, no entanto existem contentores padrão GN noutros materiais igualmente adequados aos processos.

Os contentores GN de aço inox podem ser lisos ou perfurados, ter ou não asas de apoio e tampas de aço inox ou de outros materiais.

Os modelos perfurados são utilizados em casos de alimentos onde não se deseja a retenção de líquidos no preparo.

Standard containers GN or Gastronorm are containers with universal dimensions according to the European standard EN-631, which establishes the materials and articles that may come into contact with food and measures for containers used in the handling, storage and distribution service of food.

The use in the professional kitchens, provides great benefits in the preparation and preparation of the food, due to a better and greater use of space in the kitchen, reduction of the need to exchange ingredients for the containers, reduction or loss of food waste, ease of hygiene and improvement of food safety.

The GN containers have a standard dimension of length and width of 530x325mm, established worldwide as 1/1. Always based on the 1/1 standard, there are multiple (2/1) and submultiples (1/2, 1/3, 1/4, 1/6, etc.) containers, enabling custom compositions within 1/1 space.

The depth of the standard GN container can vary from manufacturer to manufacturer, ranging from 20 to 200 mm.

For greater resistance to low / high temperatures, ease of transport, durability and hygiene, the most common materials used are stainless steel and polycarbonate, however there are standard GN containers in other materials equally suited to the processes.

Stainless steel GN containers can be smooth or perforated, have support wings and stainless steel or other material covers.

The perforated models are used in food cases where liquid retention is not desired in the preparation.

Los contenedores estándar GN o contenedores Gastronorm son dimensiones universales según la norma EN-631 Europea, que establece qué materiales y objetos destinados a entrar en contacto con los alimentos y las medidas de los contenedores utilizados en el servicio de manejo, conservación y distribución de alimentos.

El uso en las cocinas profesionales, ofrece importantes beneficios en la preparación y cocción de los alimentos, debido a una mejor y mayor espacio en la cocina, lo que reduce la necesidad de intercambio de ingredientes para los contenedores, o la pérdida de los residuos de alimentos disminución, facilidad de limpieza y mejora del nivel de seguridad de los alimentos.

Recipientes GN, tienen una dimensión de longitud estándar y una anchura de 530x325mm, a nivel mundial establecido como 1/1. Donde basado en el patrón de 1/1, existen múltiples contenedores (2/1) y submúltiplos (1/2, 1/3, 1/4, 1/6, etc.), lo que permite composiciones personalizadas dentro del alcance 1/1.

La profundidad del recipiente GN patrón puede variar de un fabricante a otro, puede variar de 20 a 200 mm.

Para una mayor resistencia a altas / bajas temperaturas, la facilidad de transporte, la durabilidad y la higiene, los materiales más comunes que se utilizan son de acero inoxidable y policarbonato, sin embargo, hay recipientes GN estándar también otros materiales adecuados para el proceso.

El contenedor de acero inoxidable GN, puede que: tener lisa o perforada, o puede no tener alas de apoyo y cubrir acero inoxidable u otros materiales. modelos perforados se utilizan en casos en los alimentos no quiere la retención de líquidos en la preparación.

Les récipients GN standard ou conteneurs Gastronorm sont des dimensions universelles selon la norme européenne EN-631, qui établit quels matériaux et articles destinés à entrer en contact avec les aliments et les mesures pour les conteneurs utilisés dans le service de traitement, la conservation et la distribution alimentaire.

L'utilisation dans les cuisines professionnelles, fournit des avantages importants dans la préparation et la cuisson des aliments, en raison d'une utilisation plus efficace et plus l'espace dans la cuisine, ce qui réduit la nécessité d'un échange d'ingrédients pour les conteneurs, ou des aliments pour diminuer la perte de déchets, la facilité de nettoyage et d'améliorer le niveau de sécurité alimentaire.

Récipients GN, ont une dimension de longueur standard et une largeur de 530x325mm, défini comme 1/1 au niveau mondial. Lorsque sur la base du modèle 1/1, il y a plusieurs conteneurs (2/1) et sous-multiples (1/2, 1/3, 1/4, 1/6, etc.), ce qui permet des compositions sur mesure dans le cadre 1/1.

La profondeur du récipient GN de motif peut varier d'un fabricant à l'autre, peut varier de 20 à 200 mm.

Pour une plus grande résistance à des températures basses / élevées, la facilité de transport, de la durabilité et de l'hygiène, les matériaux les plus couramment utilisés sont en acier inoxydable et en polycarbonate, mais il y a des bacs GN standards aussi d'autres matériaux appropriés pour le processus.

Le récipient GN en acier inoxydable, ils peuvent: être lisses ou perforés, ou peut ne pas avoir des ailes de support et recouvre l'acier inoxydable ou d'autres matériaux. modèles perforés sont utilisés dans les cas où la nourriture ne veut pas la rétention d'eau dans la préparation.



TRANSPORTE / ARMAZENAMENTO

transport/storage transporte/almacenamiento transport/stockage



múltiplas combinações profissionais

multiple combinations professionals
múltiples combinaciones profesionales
multiples combinaisons professionnels

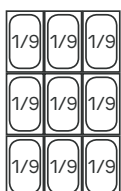
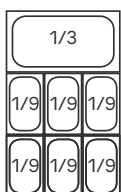
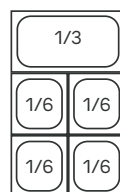
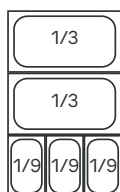
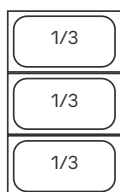
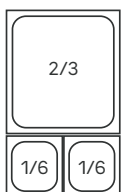
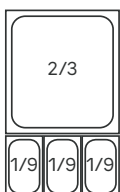
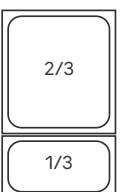
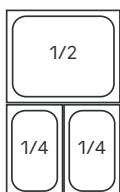
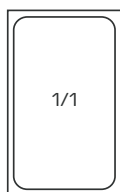
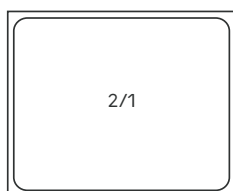

MEDIDAS D/ENCASTRE

fitting measures
medidas de encastre
mesures d'emboitement

| GN | DIMENSÕES (mm) | | |
|-----|----------------|-----------|-----------|
| | dimension | dimension | dimension |
| 2/1 | 650 | x | 530 |
| 2/4 | 530 | x | 162 |
| 1/1 | 530 | x | 325 |
| 2/3 | 354 | x | 325 |
| 1/2 | 265 | x | 325 |
| 1/3 | 176 | x | 325 |
| 1/4 | 162 | x | 265 |
| 1/6 | 176 | x | 162 |
| 1/9 | 176 | x | 108 |





CONTENTOR
container contenedor bac

| REF | (mm) | LT | |
|-------------|------|------|--------|
| 04306810011 | 20 | 6.5 | 01/006 |
| 04326110202 | 20 | 6.5 | 01/006 |
| 0430681002 | 40 | 11 | 01/006 |
| 04326110652 | 65 | 18 | 01/006 |
| 04306810041 | 100 | 31.5 | 01/006 |
| 04326112001 | 200 | 56 | 01/006 |



CONTENTOR
container contenedor bac

| REF | (mm) | LT | |
|-------------|------|------|--------|
| 04326130652 | 65 | 5.5 | 01/006 |
| 04326131001 | 100 | 8.9 | 01/006 |
| 04326132001 | 200 | 19.3 | 01/006 |



CONTENTOR
container contenedor bac

| REF | (mm) | LT | |
|------------|------|-----|--------|
| 0432614040 | 40 | 2.4 | 01/006 |



CONTENTOR
container contenedor bac

| REF | (mm) | LT | |
|------------|------|------|--------|
| 0733610494 | 10 | - | 01/006 |
| 0432611020 | 20 | 3 | 01/006 |
| 0432611040 | 40 | 5.5 | 01/006 |
| 0432611065 | 65 | 8.5 | 01/006 |
| 0432611100 | 100 | 13.5 | 01/006 |
| 0432611150 | 150 | 20.6 | 01/006 |
| 0432611200 | 200 | 30 | 01/006 |



CONTENTOR
container contenedor bac

| REF | (mm) | LT | |
|------------|------|------|--------|
| 0432612020 | 20 | 3 | 06/012 |
| 0432612040 | 40 | 2.5 | 06/012 |
| 0432612065 | 65 | 4.2 | 06/012 |
| 0432612100 | 100 | 8 | 06/012 |
| 0432612150 | 150 | 9.9 | 06/012 |
| 0432612200 | 200 | 11.6 | 06/012 |



CONTENTOR
container contenedor bac

| REF | (mm) | LT | |
|-------------|------|-----|--------|
| 0432613020 | 20 | 0.9 | 01/006 |
| 04326130401 | 40 | 1.6 | 01/006 |
| 0432613065 | 65 | 2.5 | 01/006 |
| 0432613100 | 100 | 3.8 | 01/006 |
| 0432613150 | 150 | 5.9 | 01/006 |
| 0432613200 | 200 | 8.1 | 01/006 |



CONTENTOR
container contenedor bac

| REF | (mm) | LT | |
|-------------|------|-----|--------|
| 0432614020 | 20 | 0.6 | 01/006 |
| 04326140401 | 40 | 1 | 01/006 |
| 0432614065 | 65 | 1.9 | 01/006 |
| 0432614100 | 100 | 2.5 | 01/006 |
| 0432614150 | 150 | 4.1 | 01/006 |
| 0432614200 | 200 | 4.9 | 01/006 |



CONTENTOR
container contenedor bac

| REF | (mm) | LT | |
|------------|------|-----|--------|
| 0432616065 | 65 | 1.1 | 01/006 |
| 0432616100 | 100 | 1.6 | 01/006 |
| 0432616150 | 150 | 2.5 | 01/006 |
| 0432616200 | 200 | 3.3 | 01/006 |



CONTENTOR
container contenedor bac

| REF | (mm) | LT | |
|------------|------|-----|--------|
| 0432619065 | 65 | 0.7 | 01/006 |
| 0432619100 | 100 | 1 | 01/006 |
| 0432619150 | 150 | 1.4 | 01/006 |



CONTENOR C/2 CUBAS
container contenedor bac

| REF | (mm) | LT | |
|------------|------|----|--------|
| 0430681941 | 65 | 4 | 01/006 |

CONTENOR C/TAMPA HERMÉTICA
container contenedor bac

| REF | (cm) | LT | |
|-------------|------------|-----|--------|
| 0433890266 | 28.5x20x9 | 3.4 | 01/080 |
| 04338902661 | 35.5x25x11 | 7.4 | 01/060 |

CONTENOR PERFURADO
perforated container contenedor perforado bac perforé

| REF | (mm) | |
|------------|------|--------|
| 0433981120 | 20 | 01/006 |
| 0433981140 | 40 | 01/006 |
| 0433981102 | 65 | 01/006 |
| 0432611001 | 100 | 01/006 |
| 0433981106 | 150 | 01/006 |

CONTENOR PERFURADO
perforated container contenedor perforado bac perforé

| REF | (mm) | |
|-------------|------|--------|
| 04326120651 | 65 | 01/006 |
| 0433988124 | 100 | 06/012 |
| 04326121001 | 100 | 01/006 |
| 04326121501 | 150 | 01/006 |

CONTENOR PERFURADO
perforated container contenedor perforado bac perforé

| REF | (mm) | |
|------------|------|--------|
| 0432613040 | 40 | 01/006 |

CONTENOR PERFURADO
perforated container contenedor perforado bac perforé

| REF | (mm) | |
|-------------|------|--------|
| 04326130651 | 65 | 01/006 |

TAMPA
lid tapa couvercle

| REF | (cm) | |
|-------------|-----------|---------------|
| 0430681007 | 65x53 | GN 2/1 01/006 |
| 04326130001 | 35.4x32.5 | GN 2/3 01/006 |
| 0432611000 | 53x32.5 | GN 1/1 01/006 |
| 0432612000 | 32.5x26.5 | GN 1/2 01/012 |
| 0432613000 | 17.6x32.5 | GN 1/3 01/018 |
| 0432614000 | 16.2x26.5 | GN 1/4 01/024 |
| 0432616000 | 17.6x16.2 | GN 1/6 01/036 |
| 0432619000 | 17.6x10.8 | GN 1/9 01/048 |

TAMPA C/ORIFÍCIO P/CONCHA
lid tapa couvercle

| REF | (cm) | |
|------------|-----------|---------------|
| 0432610011 | 53x32.5 | GN 1/1 01/006 |
| 0432610012 | 17.6x32.5 | GN 1/2 01/012 |
| 0432610013 | 17.6x32.5 | GN 1/3 01/018 |
| 0432610014 | 16.2x26.5 | GN 1/4 01/024 |
| 0432610016 | 17.6x16.2 | GN 1/6 01/036 |
| 0432610019 | 17.6x10.8 | GN 1/9 01/048 |



TAMPA
lid tapa couvercle

| REF | (cm) | | |
|------------|-----------|--------|--------|
| 0430681309 | 17.6x32.5 | GN 1/3 | 01/018 |



TAMPA
LID TAPA COUVERCLE

| REF | (cm) | | |
|-------------|-----------|--------|--------|
| 04326100111 | 53x32.5 | GN 1/1 | 01/006 |
| 04326100121 | 32.5x26.5 | GN 1/2 | 01/012 |
| 04326100131 | 17.6x32.5 | GN 1/3 | 01/018 |
| 04326100141 | 16.2x26.5 | GN 1/4 | 01/024 |



TAMPA
lid tapa couvercle

| REF | (cm) | | |
|------------|-----------|--------|--------|
| 0430681210 | 32.5x24.5 | GN 1/2 | 01/012 |
| 0430681310 | 17.6x32.5 | GN 1/3 | 01/018 |
| 0430681410 | 16.2x26.5 | GN 1/4 | 01/024 |



TAMPA ARTICULADA
lid tapa couvercle

| REF | (cm) | | |
|------------|-----------|--------|--------|
| 0430681943 | 53x32.5x9 | GN 1/1 | 01/012 |

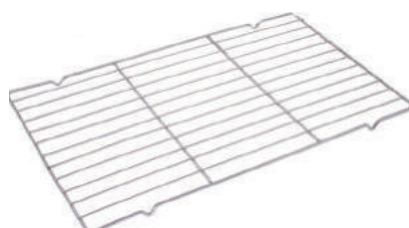

GRELHA
grate parrilla grille

| REF | (cm) | | |
|------------|---------|--------|--------|
| 0433658153 | 53x32.5 | GN 1/1 | 01/030 |

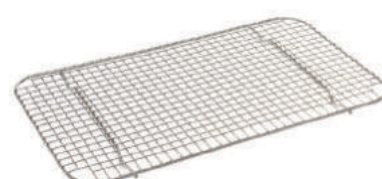

GRELHA
grate parrilla grille

| REF | (cm) | | |
|------------|-----------|--------|--------|
| 0432611001 | 53x32.5 | GN 1/1 | 01/024 |
| 0432611002 | 26.5x32.5 | GN 1/2 | 01/048 |



FUNDO PERFURADO
perforated bottom fondo perforado égouttoir

| REF | (cm) | | |
|------------|---------------|--------|--------|
| 0430681108 | 47x27x1.5 | GN 1/1 | 01/006 |
| 0430687112 | 26.5x20.5x1.5 | GN 1/2 | 01/010 |
| 0733610088 | 43x22x1.5 | | 10/020 |
| 0733610087 | 43x22x1.5 | | 10/040 |



GUIA DIVISÓRIA
splitting guides guia divisória barrete de séparation

| REF | (cm) | | |
|------------|-------------|--------|--------|
| 0432611021 | 53.2x25x0.6 | GN 1/1 | 01/144 |
| 0432611022 | 32.9x25x0.6 | GN 1/2 | 01/024 |



SUPORTE COMPATÍVEL GN
support for GN porte para GN support pour GN

| REF | (cm) | | |
|------------|--------------|--|--------|
| 0433980000 | 35x41.8x25.5 | | 01/001 |



-40°F - 210°F
-40°C -100°C

CONTENTORES em policarbonato

polycarbonate containers contenedores de policarbonato bacs en polycarbonate

Os contentores GN em policarbonato podem ser utilizados nos processos de congelação e refrigeração e micro-ondas.
São práticos, leves, higiénicos e fáceis de limpar. Podem ser lavados na máquina de lavar.

Polycarbonate GN containers can be used in the freezing and refrigeration and microwave processes. They are practical, lightweight, hygienic and easy to clean. They can be washed in the washing machine.

Los contenedores GN de policarbonato pueden ser utilizado en procesos de congelación y de refrigeración y microondas.
Son prácticos, ligero, higiénico y fácil de limpiar. Se pueden lavar en la lavadora.

Les bacs GN en polycarbonate peuvent être utilisés dans les procédés de congélation, de réfrigération et micro-ondes.
Ils sont pratiques, légers, hygiéniques et faciles à nettoyer. Ils peuvent être utilisés en lave-vaisselle.



PC GN 1/2

CONTENTOR
container contenedor bac

| REF | (mm) | LT | |
|------------|------|-----|--------|
| 0730260122 | 65 | 3.9 | 01/012 |
| 0732960153 | 100 | 5.9 | 01/018 |
| 0730260124 | 100 | 5.9 | 01/012 |
| 0732960155 | 200 | 11 | 00/012 |

PC GN 1/2

CONTENTOR
container contenedor bac

| REF | (mm) | LT | |
|-------------|------|----|--------|
| 07329601521 | 65 | 11 | 01/024 |



PC GN 1/3

CONTENTOR
container contenedor bac

| REF | (mm) | LT | |
|------------|------|-----|--------|
| 0730260132 | 65 | 2.5 | 01/024 |
| 0732960158 | 100 | 3.5 | 01/024 |
| 0733610011 | 150 | 5.3 | 01/024 |
| 0733610012 | 200 | 6.9 | 01/012 |
| 0730260138 | 200 | 6.9 | 01/024 |

PC GN 1/3

CONTENTOR
container contenedor bac

| REF | (mm) | LT | |
|-------------|------|-----|--------|
| 0732960157 | 65 | 2.5 | 01/024 |
| 07329601581 | 100 | 3.5 | 01/024 |



GN 1/1

PC

CONTENTOR
container contenedor bac

| REF | (mm) | LT | |
|------------|------|------|--------|
| 0730260112 | 65 | 8.5 | 01/012 |
| 0730260114 | 100 | 13 | 06/012 |
| 0732960163 | 100 | 12 | 01/012 |
| 0730260118 | 200 | 25.6 | 01/012 |





PC GN 1/6

CONTENTOR
container contenedor bac

| REF | (mm) | LT | |
|------------|------|----|--------|
| 0732960143 | 65 | - | 01/024 |
| 0732960144 | 100 | - | 01/024 |



PC GN 1/4

CONTENTOR
container contenedor bac

| REF | (mm) | LT | |
|------------|------|----|--------|
| 0732960170 | 65 | - | 01/024 |
| 0732960148 | 100 | - | 01/024 |



PC GN 1/9

CONTENTOR
container contenedor bac

| REF | (mm) | LT | |
|------------|------|-----|--------|
| 0730260194 | 100 | 0.8 | 01/048 |

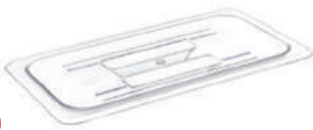

PC

TAMPA
lid tapa couvercle

| REF | (mm) | | |
|-------------|-----------|--------|--------|
| 07302600111 | 53x32.5 | GN 1/1 | 01/012 |
| 0730260012 | 32.5x26.5 | GN 1/2 | 01/024 |
| 0730260013 | 17.6x32.5 | GN 1/3 | 01/024 |



PC

CONTENTOR
container contenedor bac

| REF | (mm) | | |
|------------|-----------|--------|--------|
| 0733610023 | 17.6x32.5 | GN 1/3 | 01/072 |
| 0730260019 | 17.6x10.8 | GN 1/9 | 01/048 |

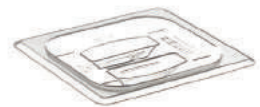

PC

TAMPA
lid tapa couvercle

| REF | (mm) | | |
|-------------|-----------|--------|--------|
| 0732960156 | 26.5x32.5 | GN 1/2 | 01/024 |
| 0732960161 | 17.5x32.5 | GN 1/3 | 01/024 |
| 0732960151 | 16x26 | GN 1/4 | 01/024 |
| 0732960147 | 16x17 | GN 1/6 | 01/024 |
| 07302600164 | 17.6x16.2 | GN 1/6 | 01/048 |

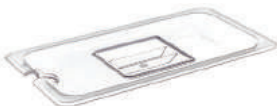

PC

TAMPA C/ORIFÍCIO P/CONCHA
lid tapa couvercle

| REF | (mm) | | |
|------------|-----------|--------|--------|
| 0733610029 | 17.6x32.5 | GN 1/3 | 01/072 |



PC

FUNDO PERFURADO
perforated bottom fondo perforado égouttoir

| REF | (mm) | | |
|------------|-------|--------|--------|
| 0733610034 | 28x22 | GN 1/2 | 01/020 |



PC

FUNDO PERFURADO
perforated bottom fondo perforado égouttoir

| REF | (mm) | | |
|-------------|---------|--------|--------|
| 07302600112 | 46.5x26 | GN 1/1 | 01/006 |



PC PE

CAIXA P/ALIMENTOS
food box caja para comida boîte alimentaire

| REF | (mm) | LT | |
|------------|------------|----|--------|
| 0733638661 | Ø31.5x30.5 | 15 | 01/008 |

tampa lid tapa couvercle Ø32.5cm



PC PE

CAIXA P/ALIMENTOS
food box caja para comida boîte alimentaire

| REF | (mm) | LT | |
|------------|----------|----|--------|
| 0733638662 | Ø31.5x21 | 10 | 01/012 |

tampa lid tapa couvercle Ø32.5cm



PC PE

CAIXA P/ALIMENTOS
food box caja para comida boîte alimentaire

| REF | (mm) | LT | |
|------------|----------|----|--------|
| 0733638664 | Ø22.5x20 | 6 | 01/032 |

tampa lid tapa couvercle Ø23.5cm



23°F - 176°F
-5°C - 80°C-40°F - 160°F
-40°C - 700°C

CONTENTORES em polipropileno

polypropylen containers contenedores de polipropileno bacs en polypropylène

Os contentores GN em polipropileno podem ser utilizados nos processos de congelação e refrigeração.

São práticos, leves, higiénicos e fáceis de limpar. Podem ser lavados na máquina de lavar.

Polypropylen GN containers can be used in the freezing and refrigeration processes.

They are practical, lightweight, hygienic and easy to clean. They can be washed in the washing machine.

Los contenedores GN de polipropileno pueden ser utilizado en procesos de congelación y de refrigeración.

Son prácticos, ligero, higiénico y fácil de limpiar. Se pueden lavar en la lavadora.

Les bacs GN en polypropylène peuvent être utilisés dans les procédés de congélation et réfrigération.

Ils sont pratiques, légers, hygiéniques et faciles à nettoyer. Ils peuvent être utilisés en lave-vaisselle.

CONTENTOR
container contenedor bac

| REF | (mm) | LT | | |
|-------------|------|----|--|--------|
| 07336100012 | 65 | - | | 01/012 |

CONTENTOR
container contenedor bac

| REF | (mm) | LT | | |
|-------------|------|------|--|--------|
| 07336100006 | 100 | 5.9 | | 01/024 |
| 07336100081 | 200 | 11.7 | | 01/012 |

CONTENTOR
container contenedor bac

| REF | (mm) | LT | | |
|-------------|------|-----|--|--------|
| 0730262134 | 100 | 3.6 | | 01/024 |
| 07336100111 | 150 | 5.3 | | 01/024 |
| 0730262138 | 200 | 6.9 | | 01/024 |

CONTENTOR
container contenedor bac

| REF | (mm) | LT | | |
|-------------|------|-----|--|--------|
| 07336100103 | 65 | 1.7 | | 01/036 |
| 07336100141 | 100 | 2.5 | | 01/036 |
| 07336100105 | 150 | 3.7 | | 01/024 |

CONTENTOR
container contenedor bac

| REF | (mm) | LT | | |
|------------|------|-----|--|--------|
| 0730262162 | 65 | 1 | | 01/048 |
| 0730262164 | 100 | 1.5 | | 01/048 |
| 0733610017 | 100 | 1.5 | | 01/048 |
| 0733610018 | 150 | 2.2 | | 01/024 |

CONTENTOR
container contenedor bac

| REF | (mm) | LT | | |
|------------|------|------|--|--------|
| 0730262194 | 100 | 0.85 | | 01/048 |

TAMPA
lid tapa couvercle

| REF | (mm) | | | |
|------------|-----------|--------|--|--------|
| 0730262011 | 53x32.5 | GN 1/1 | | 01/012 |
| 0730262013 | 26.5x16.2 | GN 1/3 | | 01/024 |
| 0730262016 | 17.6x16.2 | GN 1/5 | | 01/048 |
| 0730262019 | 17.5x10.8 | GN 1/9 | | 01/048 |

TAMPA
lid tapa couvercle

| REF | (mm) | | | |
|-------------|-----------|--------|--|--------|
| 07336100391 | 32.5x26.5 | GN 1/2 | | 01/048 |
| 0733610040 | 26.5x16.2 | GN 1/3 | | 01/072 |
| 0733610041 | 32.5x17.6 | GN 1/4 | | 01/072 |
| 0733610042 | 17.6x16.2 | GN 1/6 | | 01/072 |



INOX **GN 1/1**

CARRO P/TABULEIROS
rack trolley carro para contenedor chariot pour bacs

| REF | (cm) | |
|------------|-------------|--------|
| 0433906416 | 47x62x173.5 | 01/001 |

com 16 calhas, para tabuleiros 60x40cm + GN1/1 (53x32.5cm)
with 16 shelves, for trays 60x40cm + GN1/1 (53x32.5cm)
con 16 estantes, para contenedores 60x40cm + GN1/1 (53x32.5cm)
avec 16 étagères, pour bacs 60x40 + GN1/1 (53x32.5cm)



INOX

CARRO P/TABULEIROS
rack trolley carro para contenedor chariot pour bacs

| REF | (cm) | |
|------------|------|--------|
| 0430680607 | - | 01/001 |

com 14 calhas, para tabuleiros 48x37cm with 14 shelves, for trays 48x37cm
con 14 estantes, para contenedores 48x37cm avec 14 étagères, pour bacs 48x37cm



INOX

CARRO P/CONTENTOR
rack trolley carro para contenedor chariot pour bacs

| REF | (cm) | |
|------------|-----------|--------|
| 0430680501 | 38x55x100 | 01/001 |

6 calhas 6 shelves 6 estantes 6 étagères



INOX

CARRO P/CONTENTOR
rack trolley carro para contenedor chariot pour bacs

| REF | (cm) | |
|------------|-----------|--------|
| 0430680502 | 74x55x100 | 01/001 |

6 calhas 6 shelves 6 estantes 6 étagères



PP **TPE** **NOVO new**

TABULEIRO ANTIDERRAPANTE
non-stik tray bandeja antideslizante plateau antidérapant

| REF | (cm) | |
|------------|-----------|--------|
| 0433900981 | 45.5x35.5 | 01/012 |



PC

TABULEIRO ANTIDERRAPANTE
non-stik tray bandeja antideslizante plateau antidérapant

| REF | (cm) | | |
|-------------|-----------|---|--------|
| 07302614181 | 45.5x35.5 | ■ | 01/024 |
| 0733631418 | 45.5x35.5 | ■ | 01/024 |

revestido a borracha rubber coated
recubierto de caucho revêtu de caoutchouc



PC

TABULEIRO ANTIDERRAPANTE
non-stik tray bandeja antideslizante plateau antidérapant

| REF | (cm) | | |
|------------|---------|---|--------|
| 0730261217 | 42.5x30 | ■ | 01/024 |
| 0730372104 | 42.5x30 | ■ | 01/024 |



TRANSPORTE / ARMAZENAMENTO

transport/storage transporte/almacenamiento transport/stockage



PC

TABULEIRO
tray bandeja plateau

| REF | (cm) | |
|------------|-------|--------|
| 0730372001 | 30x20 | 01/030 |



PP

TABULEIRO SELF-SERVICE
non-slik tray bandeja antideslizante plateau antidérapant

| REF | (cm) | | | |
|-------------|---------------|---|--|--------|
| 0733610113 | 41.3x30.3x2.3 | ■ | | 01/060 |
| 07336101131 | 41.3x30.3x2.3 | ■ | | 01/060 |



PP

TABULEIRO
tray bandeja plateau

| REF | (cm) | | | |
|------------|-------------|-------|--|--------|
| 0732960226 | 30.3x40.8x2 | ■ ■ ■ | | 01/036 |



INOX

CARRO SERVIÇO C/3 PRATELEIRAS
service trolley carro servicio chariot de service

| REF | (cm) | |
|------------|----------|--------|
| 0433900003 | 81x46x91 | 01/001 |



INOX

CARRO SERVIÇO C/2 PRATELEIRAS
service trolley carro servicio chariot de service

| REF | (cm) | |
|------------|----------|--------|
| 0431430020 | 80x45x85 | 01/001 |



INOX

CARRO SERVIÇO C/CUBAS
service trolley carro servicio chariot de service

| REF | (cm) | |
|------------|----------|--------|
| 0430680711 | 80x44x90 | 01/001 |



PP

CARRO SERVIÇO C/3 PRATELEIRAS
service trolley carro servicio chariot de service

| REF | (cm) | | |
|-------------|----------|---|--------|
| 0730370161 | 90x50x95 | ■ | 01/001 |
| 07303701612 | 90x50x95 | ■ | 01/001 |



PLÁSTICO
plastic

BALDE
bin balde seau

| REF | (cm) | LT | |
|------------|------------|----|--------|
| 0730378633 | 1 33x23x18 | 13 | 01/005 |
| 0730378632 | 2 33x20x55 | 40 | 01/005 |





84 un.

48 un.

INOX

CARRO PORTA-PRATOS

plate stack trolley
carro portaplato
chariots à assiettes



| REF | (cm) | |
|------------|-----------|--------|
| 0730260048 | 56x56x126 | 01/001 |
| 0730260084 | 60x60x190 | 01/01 |

permitem maior economia de tempo e de espaço
são flexíveis e versáteis, podem estar colocados sobre rodas, parede ou sobre a mesa
permitem preparar e guardar um máximo de pratos com o mesmo diâmetro e altura num espaço reduzido

save time and space
are flexible and versatile, can be placed on wheels, wall or on the table
allow to prepare and store a maximum of plates of the same diameter and height in a reduced space

permitirá un mayor ahorro en tiempo y espacio
son flexibles y versátiles, se pueden colocar en las ruedas, la pared o sobre la mesa
permitir a preparar y almacenar un máximo de placas con el mismo diámetro y la altura en un espacio pequeño

permettent un gain de temps et d'espace
ils sont souples et polyvalents, peuvent être placés sur les roues, le mur ou sur la table
permettent la préparation et un stockage maximum de plats avec un même diamètre / hauteur dans un espace réduit.

240 un.

240 un.

PE

CARRO SERVICO P/PRATOS

service trolley for plates
carro servicio para platos
chariot de service pour assiettes



| REF | (cm) | |
|-------------|----------|--------|
| 07302602401 | 93x72x80 | 01/001 |

6 colunas separadoras
ajuste único e fácil pelo topo
tamanho dos pratos Ø11 a Ø33cm

6 dividers
unique and easy adjustment from the top
size plates Ø 11 to Ø33cm

6 columns separadoras
ajuste único e fácil por la parte superior
tamaño platos Ø 11 a Ø33cm

6 colonnes de séparation
reglage unique et facile de la partie supérieure
taille assiettes Ø11 a Ø33cm

combinações combinaitions combinaisons combinations





TERMOTRANS

termotrans termotrans termotrans

Os TERMOTRANS são recipientes isotérmicos leves e robustos, ideais para transportar alimentos sólidos através de contentores GN e líquidos através de uma torneira.

THERMOTRANS are lightweight and robust isothermal containers, ideal for transporting solid foods through GN containers and liquids through a faucet.

Los THERMOTRANS son recipientes isotérmicos ligero y robusto, ideal para el transporte de sólidos y líquidos a través de recipientes GN través de un grifo.

Les THERMOTRANS sont des caissons isothermes légers et robustes, parfaits pour le transport de solides grâce aux containers et de liquides GN via un robinet.

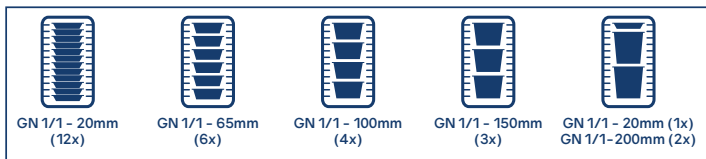
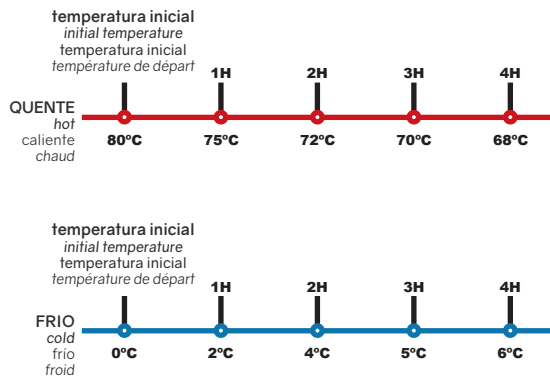

TERMOTRANS P/SÓLIDOS
thermotrans for solids
termotrans para sólidos
caissons isotherme

| REF | (cm) | LT | |
|------------|---------------|---------|--------|
| 0730260600 | 1 70x50.8x120 | 80 (x2) | 01/001 |
| 0730260300 | 2 68x47.7x62 | 72 | 01/001 |

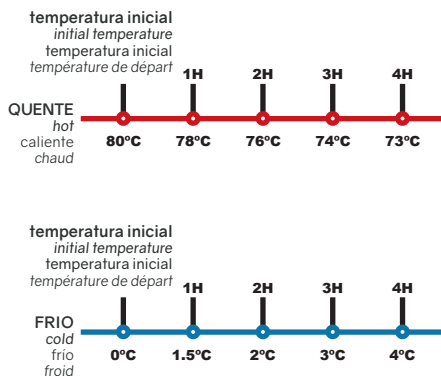

TERMOTRANS P/LÍQUIDOS
thermotrans for liquids
termotrans para líquidos
caissons isotherme

| REF | (cm) | LT | |
|-------------|------------------|------|--------|
| 0730260445 | 1 52.5x42.5x63.5 | 44.5 | 01/001 |
| 0730260094 | 2 41x23x46 | 9.4 | 01/001 |
| 07302600018 | 41x23x61 | 18 | 01/001 |



CARRRO TRANSPORTE P/TERMOTRANS
thermotrans transport trolley
transporte para termotrans
transporte termotrans

| REF | (cm) | LT | |
|------------|---------|------|--------|
| 0730260201 | 70x50.8 | 44.5 | 01/001 |



PANELA TERMO ROBUSTA
thermal pot olla termo marmite isotherme

| REF | (cm) | LT | |
|------------|--------|----|--------|
| 0430683102 | Ø30x30 | 15 | 01/001 |
| 0430683103 | Ø33x33 | 25 | 01/001 |
| 0430683104 | Ø43x43 | 35 | 01/001 |



PANELA TERMO ROBUSTA
thermal pot olla termo marmite isotherme

| REF | (cm) | LT | |
|------------|--------|----|--------|
| 0433900020 | Ø30x31 | 20 | 01/001 |



PANELA TERMO
thermal pot olla termo marmite isotherme

| REF | (cm) | LT | |
|------------|------------|----|---------------------------|
| 0433890710 | Ø29x31 | 10 | 01/001 |
| 0433890725 | Ø33.8x36.5 | 20 | NOVO new 01/006 |



PANELA TERMO
thermal pot olla termo marmite isotherme

| REF | (cm) | LT | | |
|-------------|--------|----|-----|--------|
| 04338913421 | Ø28x46 | 21 | ■ ■ | 01/100 |



PANELA TERMO
thermal pot olla termo marmite isotherme

| REF | (cm) | LT | | |
|-------------|--------|----|-----|--------|
| 04338913530 | Ø40x36 | 30 | ■ ■ | 01/050 |



JUNTA VEDAÇÃO
gasket junta de sellado joint d'étanchéité

| REF | (cm) | |
|------------|------|--------|
| 0430682591 | Ø25 | 01/001 |
| 0430682593 | Ø35 | 01/001 |
| 0430682594 | Ø40 | 01/001 |



TRANSPORTE / ARMAZENAMENTO

transport/storage transporte/almacenamiento transport/stockage



buffet buffet buffet buffet



TERMO ELÉCTRICO - LEITE

electric term - milk
termo eléctrico - leche
thermos électrique - lait

| REF | (cm) | LT | |
|-------------|------------|----|--------|
| 1337930001 | 31x28x52 | 5 | 01/001 |
| 13379300012 | 35x32x61.5 | 10 | 01/001 |

MODELO model modelo modèle **31TL010101**
PESO weight peso poids 8.7KG
CAPACIDADE capacity capacidad capacité 5L
VOLTAGEM voltage voltaje voltage 230V
FREQUÊNCIA frequency frecuencia fréquence 50HZ
POTÊNCIA power potencia puissance 1200W

MODELO model modelo modèle **31TL020101**
PESO weight peso poids 12.8KG
CAPACIDADE capacity capacidad capacité 10L
VOLTAGEM voltage voltaje voltage 230V
FREQUÊNCIA frequency frecuencia fréquence 50HZ
POTÊNCIA power potencia puissance 1200W



TERMO ELÉCTRICO - CAFÉ

electric term - coffee
termo eléctrico - café
thermos électrique - café

| REF | (cm) | LT | |
|-------------|------------|----|--------|
| 04339000101 | Ø21.5x48.5 | 10 | 01/001 |

MODELO model modelo modèle **ECM10**
CAPACIDADE capacity capacidad capacité 10L
TEMPERATURA temperature temperatura temperature 10-38°C
VOLTAGEM voltage voltaje voltage 220V
FREQUÊNCIA frequency frecuencia fréquence 50HZ
POTÊNCIA power potencia puissance 900KW



TERMO ELÉCTRICO - CAFÉ

electric term - coffee
termo eléctrico - café
thermos électrique - café

| REF | (cm) | LT | |
|-------------|------------|------|--------|
| 1332100006 | Ø22.7x44.5 | 6 ** | 01/001 |
| 13321000150 | Ø26x60.6 | 15 | 01/001 |

****MODELO model modelo modèle CP06A**
PESO weight peso poids 3.5KG
CAPACIDADE capacity capacidad capacité 10L/H
VOLTAGEM voltage voltaje voltage 230/110V
FREQUÊNCIA frequency frecuencia fréquence 50/60HZ
POTÊNCIA power potencia puissance 1250W
COM BASE with base con base avec base

MODELO model modelo modèle **CP15A**
PESO weight peso poids 4.1KG
CAPACIDADE capacity capacidad capacité 20L/H
VOLTAGEM voltage voltaje voltage 230/110V
FREQUÊNCIA frequency frecuencia fréquence 50/60HZ
POTÊNCIA power potencia puissance 1250W



TERMO ELÉCTRICO - CAFÉ

electric term - coffee
termo eléctrico - café
thermos électrique - café



| REF | (cm) | LT | |
|------------|--------|----|--------|
| 0432100010 | Ø22x43 | 10 | 01/001 |
| 0432100015 | Ø27x45 | 15 | 01/001 |

MODELO model modelo modèle **WB-10**

CAPACIDADE capacity capacidad capacité **10L**

TEMPERATURA temperature temperatura température **10-38°C**

VOLTAGEM voltage voltaje voltage **220V**

FREQUÊNCIA frequency frecuencia fréquence **50HZ**

POTÊNCIA power potencia puissance **2KW**

COM BASE with base con base avec base

MODELO model modelo modèle **WB-15**

CAPACIDADE capacity capacidad capacité **15L**

TEMPERATURA temperature temperatura température **10-38°C**

VOLTAGEM voltage voltaje voltage **240V**

FREQUÊNCIA frequency frecuencia fréquence **50HZ**

POTÊNCIA power potencia puissance **2.5KW**



TERMO

term termo thermos

| REF | (cm) | LT | |
|------------|----------|----|--------|
| 0433540080 | Ø23x30 | 8 | 01/001 |
| 0433540120 | Ø23x44.6 | 12 | 01/004 |

TORNEIRA P/TERMOS

tap grifo robinet

| REF | (cm) | LT | |
|-------------|------|------|--------|
| 04335400801 | - | 8/12 | 01/060 |



TERMO C/SIFÃO

term termo thermos

| REF | (cm) | LT | |
|------------|--------|-----|--------|
| 0433540025 | Ø23x30 | 2.5 | 01/006 |

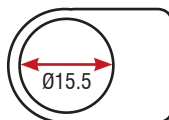

BASE ANTIGOTA P/TERMO

base for term base para termo base pour thermos

| REF | (cm) | |
|------------|---------|--------|
| 0433540001 | 23x18x4 | 01/006 |



TERMO C/SIFÃO

term termo thermos

| REF | (cm) | LT | |
|------------|--------|----|--------|
| 0431270040 | Ø17x39 | 4 | 01/060 |



TERMO C/SIFÃO

term termo thermos

| REF | (cm) | LT | |
|-------------|--------|----|--------|
| 04335400502 | Ø15x36 | 5 | 01/006 |



CAFETEIRA TERMO PINGUIM

coffee term bottle cafetera termo cafetière thermos

| REF | (cm) | LT | |
|------------|----------|-----|--------|
| 0433900010 | Ø13x21 | 1 | 01/024 |
| 0433900011 | Ø14x25 | 1.5 | 01/024 |
| 0433900012 | Ø14x27.5 | 2 | 01/024 |



CAFETEIRA TERMO PINGUIM

coffee term bottle cafetera termo cafetière thermos

| REF | (cm) | LT | |
|------------|----------|------|--------|
| 0430681612 | Ø13x23 | 1 | 01/012 |
| 0430681613 | Ø31x54 | 1.5 | 01/012 |
| 0430681611 | Ø12,5x20 | 0.75 | 01/012 |



TRANSPORTE / ARMAZENAMENTO

transport/storage transporte/almacenamiento transport/stockage

PP

INOX



CAFETEIRA TERMO PINGUIM

coffee term bottle cafetera termo cafetière thermos

| REF | (cm) | LT | |
|-------------|----------|-----|--------|
| 04335400101 | Ø13.5x20 | 1 | 01/006 |
| 0433540015 | Ø13.5x22 | 1.5 | 01/006 |
| 04335400201 | Ø13.5x26 | 2 | 01/006 |

INOX

PP



CAFETEIRA TERMO

coffee term bottle cafetera termo cafetière thermos

| REF | (cm) | LT | |
|------------|--------|-----|--------|
| 0430752031 | Ø13x23 | 1 | 01/012 |
| 0430752032 | Ø13x26 | 1.3 | 01/012 |

INOX

PP



CAFETEIRA TERMO

coffee term bottle cafetera termo cafetière thermos

| REF | (cm) | LT | |
|------------|------------|----|--------|
| 0433540010 | Ø13.5x20.5 | 1 | 01/001 |



INOX

PP



CAFETEIRA TERMO

coffee term bottle cafetera termo cafetière thermos

| REF | (cm) | LT | |
|------------|------------|-----|--------|
| 0433540005 | Ø10.5x19.5 | 0.5 | 01/006 |

INOX



CAFETEIRA TERMO

coffee term bottle cafetera termo cafetière thermos

| REF | (cm) | LT | |
|------------|--------|-----|--------|
| 0431270006 | Ø14x17 | 0.6 | 01/012 |

tampa disponível em 3 cores
cover available in 3 colors
cubierta disponible en 3 colores
couverture disponible en 3 couleurs



INOX

PLACA

table stand placa plaque

| REF | (cm) | LT | |
|-------------|---------|-----|--------|
| 04312600015 | 6.2x5.5 | 1 | 01/025 |
| 04312600036 | 6.2x5.5 | 1.5 | 01/025 |
| 04312600056 | 6.2x5.5 | 2 | 01/025 |

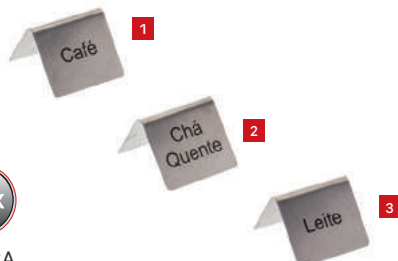



MENU/APRESENTAÇÃO

menu/presentation
menú/presentación
menu/présentation



PLACAS NUMÉRICAS

table number placas numéricas plaques numériques

| REF | (cm) | | |
|-------------|---------------------|--|--------|
| 04306801101 | 5.2x4.2x3.5 1-10 | | 01/012 |
| 04306801102 | 5.2x4.2x3.5 11-20 | | 01/012 |
| 04306801103 | 5.2x4.2x3.5 21-30 | | 01/012 |
| 04306801104 | 5.2x4.2x3.5 31-40 | | 01/012 |



PLACAS NUMÉRICAS

table number placas numéricas plaques numériques

| REF | (cm) | | |
|-------------|-------------------|--|--------|
| 0433659531 | 7.5x6.5x5 1-10 | | 01/100 |
| 04336595311 | 7.5x6.5x5 11-20 | | 01/100 |
| 04336595312 | 7.5x6.5x5 21-30 | | 01/100 |



PLACA "RESERVADO"

"reserved" table sign placa "reservado" plaque "reservé"

| REF | (cm) | | |
|--------------------------|------|--|--------|
| 0433652021 ¹ | 12x6 | | 01/100 |
| 04312600027 ² | 12x6 | | 01/100 |



PLACA PRECÁRIO

price board tarjeta precios plaque liste prix

| REF | (cm) | | |
|------------|------|--|--------|
| 0230468497 | 6x3 | | 40/400 |



SUPOORTE MENÚ

menu card holder soporte menu support menu

| REF | (cm) | | |
|-------------------------|----------|--|--------|
| 0432790027 ¹ | Ø5.6x5.6 | | 72/288 |
| 0430680605 ² | Ø3.5x7 | | 48/384 |



PORTA PREÇOS

menu card holder soporte menu support menu

| REF | (cm) | | |
|------------|------|--|--------|
| 0431269009 | 9 | | 01/360 |



PORTA PREÇOS

menu card holder soporte menu support menu

| REF | (cm) | | |
|-------------------------|------|--|--------|
| 0431260004 ¹ | 10 | | 01/050 |
| 0431260008 ² | 20 | | 01/050 |
| 0433940008 ³ | 21 | | 10/100 |



SUPOORTE MENÚ

menu card holder soporte menu support menu

| REF | (cm) | | |
|-------------------------|------|--|--------|
| 0732306009 ¹ | 20.5 | | 01/500 |
| 0732304025 ² | 15 | | 01/170 |



PORTA CONTAS

bill holder porta facturas plateau à addition

| REF | (cm) | | |
|------------|---------|---|--------|
| 0430720026 | 23x13.5 | ■ | 01/008 |



EMENTA

menu holder portamenús porte-menus

| REF | (cm) | | |
|------------|-------|---|--------|
| 0430720029 | 32x23 | ■ | 01/036 |
| 0430720028 | 27x20 | ■ | 01/048 |
| 0430720027 | 29x13 | ■ | 01/050 |

com 6 folhas with 6 sheets con 6 hojas avec 6 feuilles



BANDEJA P/TROCOS

change plate platillo cambio porte-addition

| REF | (cm) | | |
|------------|---------|--|--------|
| 0433659121 | 17x10.5 | | 01/060 |
| 0433659125 | 21x12.5 | | 01/040 |



BANDEJA P/TROCOS

change plate platillo cambio porte-addition

| REF | (cm) | | |
|-------------|-------|--|--------|
| 04324300017 | 15x11 | | 00/048 |



BANDEJA P/TROCOS

change plate platillo cambio porte-addition

| REF | (cm) | | |
|------------|-------|--|--------|
| 0432431911 | 19x11 | | 01/100 |



PRATO P/TROCOS

change plate platillo cambio porte-addition

| REF | (cm) | | |
|-------------|------|--|--------|
| 04312600052 | Ø14 | | 10/100 |



PRATO P/TROCOS

change plate platillo cambio porte-addition

| REF | (cm) | | |
|------------|------|--|--------|
| 0433659112 | Ø12 | | 01/120 |



ESPETO PEDIDOS

order spit pincho a la orden pique fiche

| REF | (cm) | | |
|------------|------|--|--------|
| 0431260924 | 24 | | 10/050 |



APANHA MIGALHAS CANETA

table crumber pala recogemigas pelle ramasse-miettes

| REF | (cm) | | |
|-------------|--------|---|--------|
| 04312600025 | 15x1.5 | ■ | 01/576 |
| 04312600037 | 15x1.5 | ■ | 01/576 |



APANHA MIGALHAS

table crumber pala recogemigas pelle ramasse-miettes

| REF | (cm) | | |
|------------|------|--|--------|
| 0433652263 | 30x7 | | 10/150 |



MOLAS P/TOALHAS MESA

spring for tablecloth
muelles para toalla
pince nappe

| REF | (cm) | | |
|------------|------|--|--------|
| 0732960801 | 5 | | 00/012 |



MENU/APRESENTAÇÃO

menu/presentation menú/presentación menu/présentation



RESINA
RESIN
RESINA
RESINE

MENU P/BALCÃO
menu menu menu

| REF | (cm) | |
|------------|-------|--------|
| 0933811247 | 21x30 | 01/008 |



RESINA
RESIN
RESINA
RESINE

COZINHEIRO P/GARRAFA
chef for bottle cocinero para botella chef pour bouteille

| REF | (cm) | |
|------------|------|--------|
| 0933811462 | 35 | 01/006 |



RESINA
RESIN
RESINA
RESINE

MENU COZINHEIRO
menu menu menu

| REF | (cm) | |
|------------|-------|--------|
| 0937167006 | 55x65 | 01/002 |



MADEIRA
WOOD
MADEIRA
BOIS

MENU
menu menu menu

| REF | (cm) | |
|------------|-------|--------|
| 0933815628 | 30x60 | 01/006 |



MADEIRA
WOOD
MADEIRA
BOIS

MENU
menu menu menu

| REF | (cm) | |
|------------|-------|--------|
| 0933812044 | 40x80 | 01/004 |



MADEIRA
WOOD
MADEIRA
BOIS

MENU BON APPETIT
menu menu menu

| REF | (cm) | |
|------------|-------|--------|
| 0933812620 | 50x70 | 01/004 |



MADEIRA
WOOD
MADEIRA
BOIS

MENU WINE SELECTION
menu menu menu

| REF | (cm) | |
|------------|-------|--------|
| 0933812525 | 30x60 | 01/006 |



MADEIRA
WOOD
MADEIRA
BOIS

MENU WINE SELECTION
menu menu menu

| REF | (cm) | |
|------------|-------|--------|
| 0933812532 | 35x70 | 01/006 |



MENU
menu menu menu

| REF | (cm) | |
|------------|--------|--------|
| 1138130003 | 45x80 | 01/001 |
| 1138130001 | 60x120 | 01/001 |

buffet buffet buffet buffet



RESINA
RESIN
RESINE

MADEIRA
WOOD
MADERA
BOIS

MENU COZINHEIRO
menu menú menu

| REF | (cm) | |
|------------|--------|--------|
| 0933810141 | 50x100 | 01/001 |



MADEIRA
WOOD
MADERA
BOIS

PLACARD "VICTORIA ARDUINO"
placard cartel cadre

| REF | (cm) | |
|------------|-------|--------|
| 0933812544 | 60x40 | 01/006 |



MADEIRA
WOOD
MADERA
BOIS

PLACARD C/RELÓGIO "BIG BEN"
placard cartel cadre

| REF | (cm) | |
|------------|-------|--------|
| 0933812182 | 60x40 | 01/006 |



MADEIRA
WOOD
MADERA
BOIS

PLACARD "HOME IS WHERE THE BEACH IS"
placard cartel cadre

| REF | (cm) | |
|------------|-------|--------|
| 0933811563 | 60x40 | 01/006 |



MADEIRA
WOOD
MADERA
BOIS

PLACARD "NO SMOKING AREA"
placard cartel cadre

| REF | (cm) | |
|------------|-------|--------|
| 0933810612 | 60x40 | 01/006 |



RESINA
RESIN
RESINE

PLACARD OPEN/CLOSE
placard cartel placard

| REF | (cm) | |
|------------|------|--------|
| 0933811307 | 30 | 01/012 |
| 0933811308 | 30 | 01/012 |



RESINA
RESIN
RESINE

VELHOTA C/BANDEJA
old lady with tray viejita con bandeja vieille dame avec plateau

| REF | (cm) | |
|------------|------|--------|
| 0937167003 | 110 | 01/001 |

INOX

COLUNA MÓVEL
barrier poste separación poteau

| REF | (cm) | |
|------------|-------|--------|
| 0733610394 | 30x85 | 01/006 |

CORDA SEPARADORA
belf cordón cordon

| REF | (MT) | |
|------------|------|--------|
| 0733610395 | 1.5 | 01/006 |







bar



INOX

BALDE GELO

ice bucket cubo de hielo seau à glace

| REF | (cm) | LT | |
|------------|--------|----|--------|
| 0433900051 | Ø19x18 | 3 | 01/012 |

parede dupla double wall doble pared paroi double



INOX

BALDE GELO

ice bucket cubo de hielo seau à glace

| REF | (cm) | LT | |
|------------|--------|-----|--------|
| 0431260035 | Ø16x18 | 1.9 | 01/012 |

parede dupla double wall doble pared paroi double



INOX

BALDE GELO

ice bucket cubo de hielo seau à glace

| REF | (cm) | LT | |
|------------|----------|-----|--------|
| 0433519001 | Ø15x16.5 | 1.5 | 01/006 |

ACRILICO
ACRYLIC
ACRILICO
ACRYLIQUE**BALDE GELO**

ice bucket cubo de hielo seau à glacen

| REF | (cm) | LT | |
|------------|--------|-----|--------|
| 0733800008 | Ø18x17 | 2.7 | 01/008 |



ABS

BALDE GELO GÔNDOLA

ice bucket cubo de hielo seau à glace

| REF | (cm) | LT | |
|------------|--------|----|--------|
| 0733997149 | Ø29x22 | 10 | 01/004 |
| 0733995719 | Ø19x20 | 4 | 01/009 |



ABS

BALDE GELO GÔNDOLA

ice bucket cubo de hielo seau à glace

| REF | (cm) | LT | |
|------------|--------|----|--------|
| 0733995718 | Ø19x20 | 4 | 01/009 |



1



2



3

INOX

BALDE GELO

ice bucket cubo de hielo seau à glace

| REF | (cm) | LT | |
|------------|----------|-----|--------|
| 0433654111 | Ø21x20.5 | 4.3 | 01/020 |
| 0433654524 | Ø24x21.5 | 8.1 | 01/008 |
| 0433654529 | Ø19x20 | 4.5 | 01/010 |





1



2



3



4

**BALDE GELO**

ice bucket cubo de hielo seau à glace

| REF | (cm) | LT | |
|-------------|--------------|------|--------|
| 0433652426 | 1 016x14.3 | 1.5 | 01/030 |
| 0431260046 | 2 021x20 | 3.9 | 06/024 |
| 04312600212 | 3 021.5x19.5 | 3.8 | 06/024 |
| 0433652711 | 4 012.5x12.5 | 1.25 | 01/030 |

**BALDE GELO SYLVANA**

ice bucket cubo de hielo seau à glace

| REF | (cm) | LT | |
|------------|--------|-----|--------|
| 0331593628 | 012x13 | 0.8 | 01/006 |

**BALDE GELO**

ice bucket cubo de hielo seau à glacen

| REF | (cm) | LT | |
|------------|------------|-----|--------|
| 0733800020 | 016.5x21.7 | 3.5 | 01/004 |

**BALDE GELO**

ice bucket cubo de hielo seau à glace

| REF | (cm) | LT | |
|------------|--------|-----|--------|
| 0731250031 | 023x23 | 4.2 | 01/006 |



1



2

**BALDE GELO VINO DUO**

ice bucket cubo de hielo seau à glace

| REF | (cm) | LT | |
|------------|--------------|-----|--------|
| 0731250012 | 1 25x14.5x21 | 4.4 | 00/006 |
| 0731250011 | 2 25x14.5x21 | 4.4 | 00/006 |



1



2

**BALDE GELO SALSA**

ice bucket cubo de hielo seau à glace

| REF | (cm) | LT | |
|-------------|--------------|-----|--------|
| 0731252447 | 1 020.5x25.3 | 3.5 | 01/006 |
| 07312524471 | 2 020.5x25.3 | 3.5 | 01/006 |



1



2

**BALDE GELO**

ice bucket cubo de hielo seau à glace

| REF | (cm) | LT | |
|-------------|------------------|----|--------|
| 0731252514 | 1 24.8x20.6x28.5 | 4 | 01/006 |
| 07312525141 | 2 24.8x20.6x28.5 | 4 | 01/006 |



1



2

**BALDE GELO SLOPE**

ice bucket cubo de hielo seau à glace

| REF | (cm) | LT | |
|-------------|------------------|-----|--------|
| 0731250013 | 1 25.3x18.5x23.8 | 3.8 | 01/006 |
| 07312500131 | 2 25.3x18.5x23.8 | 3.8 | 01/006 |



1

PS

BALDE GELO GÔNDOLA

ice bucket cubo de hielo seau à glace

| REF | (cm) | LT | |
|-------------|----------------|----|--------|
| 04329300032 | 1 26.6x20x19.7 | 4 | 01/012 |
| 04329300031 | 2 26.6x20x19.7 | 4 | 01/012 |
| 0731252498 | 3 35x27x26 | 5 | 01/006 |



2



3



PC

BALDE GELO BANHEIRA

ice bucket cubo de hielo seau à glace

| REF | (cm) | LT | |
|------------|----------|----|--------|
| 0731250019 | 48x34x28 | 10 | 01/004 |

ACRÍLICO
ACRYLIC
ACRÍLICO
ACRYLIQUE**BALDE GELO**

ice bucket cubo de hielo seau à glace

| REF | (cm) | LT | |
|------------|--------------|----|--------|
| 0734040074 | 30.7x21.5x26 | - | 01/004 |



PC

BALDE GELO DUPLO

ice bucket cubo de hielo seau à glace

| REF | (cm) | LT | |
|-------------|----------------|-----|--------|
| 07312524451 | 30.3x21.4x26.1 | 4.5 | 01/006 |



PC

BALDE GELO

ice bucket cubo de hielo seau à glace

| REF | (cm) | LT | |
|------------|----------------|----|--------|
| 0731252655 | 32.9x31.8x25.9 | 9 | 01/004 |

ACRÍLICO
ACRYLIC
ACRÍLICO
ACRYLIQUE**BALDE GELO HAPPY HOURS**

ice bucket cubo de hielo seau à glace

| REF | (cm) | LT | |
|-------------|----------------|----|--------|
| 07312500101 | 31.7x21.5x24.6 | 7 | 01/006 |



PC

BALDE GELO

ice bucket cubo de hielo seau à glace

| REF | (cm) | LT | |
|------------|----------|-----|--------|
| 0732960599 | Ø20x23 | 4.5 | 01/020 |
| 0732960598 | Ø13x14.5 | 0.9 | 01/020 |

INOX **NOVO
new****BALDE GELO**

ice bucket cubo de hielo seau à glace

| REF | (cm) | LT | |
|------------|----------|----|--------|
| 0433651410 | 43x29x19 | 10 | 01/001 |



INOX

BALDE GELO

ice bucket cubo de hielo seau à glace

| REF | (cm) | LT | |
|-------------|--------|------|--------|
| 04327900131 | Ø30x26 | 12.3 | 10/012 |



INOX

CHAMPANHEIRA

champagne bowl champañera seau à champagne

| REF | (cm) | LT | |
|------------|--------|----|--------|
| 0432619012 | Ø40x23 | 15 | 00/001 |



INOX

CHAMPANHEIRA

champagne bowl champañera seau à champagne

| REF | (cm) | LT | |
|-------------|----------|----|--------|
| 04324300341 | Ø35x20.2 | 9 | 01/006 |

**BALDE GELO**

ice bucket cubo de hielo seau à glace

| REF | (cm) | LT | |
|------------|--------|-----|--------|
| 0430943587 | Ø21x22 | 4.2 | 06/012 |

**SUPORTE P/BALDE DE GELO**

ice bucket holder soporte para cubo de hielo support seau à glace

| REF | (cm) | |
|------------|----------|--------|
| 0430940020 | Ø20.2x70 | 00/001 |

**BALDE GELO**

ice bucket cubo de hielo seau à glace

| REF | (cm) | LT | |
|------------|--------|-----|--------|
| 0430943587 | Ø21x22 | 4.2 | 06/012 |

**SUPORTE P/BALDE DE GELO**

ice bucket holder soporte para cubo de hielo support seau à glace

| REF | (cm) | |
|------------|-----------|--------|
| 0430947709 | Ø20x15x79 | 00/001 |

**SUPORTE P/BALDE DE GELO**

ice bucket holder soporte para cubo de hielo support seau à glace

| REF | (cm) | |
|-------------|--------|--------|
| 04324300013 | Ø21x60 | 00/001 |

**SUPORTE P/BALDE DE GELO**

ice bucket holder soporte para cubo de hielo support seau à glace

| REF | (cm) | |
|------------|----------|--------|
| 0433655005 | Ø21.5x60 | 00/004 |

**PINÇA**

fong pinza pince

| REF | (cm) | |
|--------------------------|------|--------|
| 04324300016 ¹ | 18 | 01/120 |
| 0432790026 ² | 15.5 | 24/144 |

**PINÇA CROCODILO**

fong pinza pince

| REF | (cm) | |
|-------------------------|------|---------|
| 0434070107 ¹ | 17.5 | 01/1000 |
| 0431260120 ² | 18 | 12/120 |

**PINÇA**

fong pinza pince

| REF | (cm) | |
|-------------------------|------|--------|
| 0433870455 ¹ | 17.5 | 00/072 |
| 0431260069 ² | 12 | 12/480 |

**PINÇA**

fong pinza pince

| REF | (cm) | |
|------------|------|--------|
| 0433518020 | 18.5 | 12/048 |
| 0432000101 | 18 | 01/150 |

**PINÇA**

fong pinza pince

| REF | (cm) | |
|--------------------------|------|--------|
| 04307210071 ¹ | 18.5 | 12/144 |
| 0733638301 ² | 16 | 12/144 |



INOX

CORREDOR
shovel librador pelle à glace

| REF | (cm) | ML | |
|-------------|------|-----|--------|
| 07336103011 | 26.5 | 532 | 00/120 |
| 0733610301 | 21.5 | 177 | 00/120 |



INOX

CORREDOR
shovel librador pelle à glace

| REF | (cm) | ML | |
|---------------------|-----------|------|--------|
| 0434070121 1 | 12.3x30.5 | 480 | 01/100 |
| 0434070122 | 10.5x29 | 360 | 01/100 |
| 0434070126 | 5.5x18 | 68 | 01/300 |
| 0430720300 2 | 5.5x18 | 3000 | 01/001 |



INOX

CORREDOR
shovel librador pelle à glace

| REF | (cm) | ML | |
|---------------------|------|------|--------|
| 0433941204 1 | 25 | 200 | 01/120 |
| 0430684604 2 | 24 | 24.2 | 12/072 |
| 0430684603 | 21.5 | 14.2 | 12/144 |
| 0430684702 3 | 26 | 360 | 01/048 |

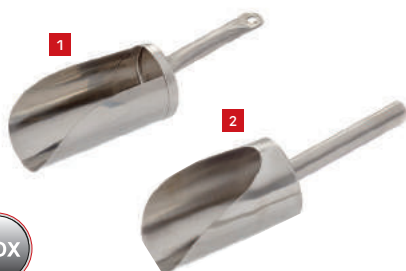

INOX

CORREDOR
shovel librador pelle à glace

| REF | (cm) | ML | |
|----------------------|----------|------|--------|
| 04312600011 1 | Ø10x37.5 | 800 | 02/024 |
| 04312600047 2 | Ø11.5x31 | 1300 | 01/036 |



AL

CORREDOR
shovel librador pelle à glace

| REF | (cm) | ML | |
|-------------|----------------------|-----|--------|
| 04307200061 | 18.5 | 180 | 12/060 |
| 0430720012 | 18.5 | 360 | 12/060 |
| 0733610086 | 21.5 NOVO new | 148 | 01/060 |

MELAMINA
melamine**CORREDOR**
shovel librador pelle à farine

| REF | (cm) | ML | |
|------------|--------------|-----|--------|
| 0734127027 | 18.7x6.4x3.8 | 160 | 69/192 |
| 0734127028 | 22.8x8.5x5 | 210 | 84/168 |

cor marfim ivory color color marfil couleur ivoire



PC

CORREDOR
shovel librador pelle à glace

| REF | (cm) | ML | |
|---------------------|------|-----|--------|
| 0730260040 1 | 19 | 180 | 00/036 |
| 0733638216 2 | 25 | 180 | 01/064 |



PC

CORREDOR
shovel librador pelle à glace

| REF | (cm) | ML | |
|------------|------|-----|--------|
| 0730260039 | 28 | 950 | 01/036 |

com ventosa
with suction cup
con ventosa
avec ventouse**PICADOR GELO**
ice crusher picadora de hielo broyeur à glace

| REF | (cm) | ML | |
|------------|------------|------|--------|
| 0733590805 | 12x12x24.5 | 1100 | 01/012 |

**PICADOR GELO**
ice crusher picadora de hielo broyeur à glace

| REF | (cm) | ML | |
|------------|------------|-----|--------|
| 0733590800 | 16x16x26.5 | 900 | 01/006 |

PICADOR GELO + ESPREMEDOR CITRINOS
ice crusher + citrus juicer
picadora de hielo + exprimidor para cítricos
broyeur à glace + presse citron

| REF | (cm) | ML | |
|------------|------------|------|--------|
| 0432170190 | 16x15x18.5 | 1110 | 01/001 |

**MÁQUINAS GELO**
ice cubes maker
máquina hacer hielo
machine à glaçons

pg. 298-299





INOX



SHAKER
shaker coctelera shaker

| REF | (cm) | CL | |
|------------|-------|------|--------|
| 0432790053 | Ø9x23 | 62.5 | 01/048 |
| 0433650156 | Ø9x23 | 60 | 01/048 |

INOX



SHAKER
shaker coctelera shaker

| REF | (cm) | CL | |
|------------|---------|----|--------|
| 0433890034 | Ø8.3x21 | 75 | 01/060 |

INOX



SHAKER
shaker coctelera shaker

| REF | (cm) | CL | |
|-------------|-------|----|--------|
| 04336501151 | Ø8x22 | 50 | 01/048 |

INOX



SHAKER
shaker coctelera shaker

| REF | (cm) | CL | |
|------------|---------|----|--------|
| 0433650117 | Ø8.6x24 | 75 | 01/024 |
| 0430681005 | Ø8.9x23 | 70 | 00/030 |

INOX



SHAKER
shaker coctelera shaker

| REF | (cm) | CL | |
|------------|--------|----|--------|
| 0433519002 | Ø10x19 | 75 | 01/012 |

INOX



SHAKER
shaker coctelera shaker

| REF | (cm) | CL | |
|-------------|-------|----|--------|
| 04312600243 | Ø9x24 | 70 | 01/078 |

ABS



SHAKER
shaker coctelera shaker

| REF | (cm) | CL | |
|------------|-----------|----|--------|
| 0733999999 | Ø7.5x19.5 | 50 | 01/090 |

INOX



SHAKER BOSTON
shaker coctelera shaker

| REF | (cm) | CL | |
|-------------|-----------|----|--------|
| 0432790090 | Ø9.2x17.5 | 82 | 01/072 |
| 04327900861 | Ø8.7x13 | 54 | 02/144 |

INOX



SHAKER BOSTON
shaker coctelera shaker

| REF | (cm) | CL | |
|-------------|-----------|----|--------|
| 0433651028 | Ø9.9x17.2 | 82 | 01/072 |
| 04324307501 | Ø9.2x17.7 | 75 | 01/096 |

INOX



SHAKER BOSTON
shaker coctelera shaker

| REF | (cm) | CL | |
|------------|-----------|----|--------|
| 0433651424 | 1 Ø9x18.3 | 82 | 01/030 |
| 0433651428 | 2 Ø9x18.3 | 82 | 01/030 |

**SHAKER BOSTON**
shaker coctelera shaker

| REF | (cm) | CL | |
|---------------------|---------|------|--------|
| 0433651138 1 | Ø9.5x17 | 82.5 | 01/058 |
| 0433651139 2 | Ø9.5x17 | 82.5 | 01/030 |

revestimento em cobre
copper coating
recubrimiento de cobre
revêtement de cuivre

**MEDIDOR**
jigger dosificador licor mesure à cocktail

| REF | (cm) | CL | |
|------------|---------|-----|--------|
| 0433659152 | Ø4 Ø4.5 | 3/5 | 25/100 |

**SHAKER BOSTON**
shaker coctelera shaker

| REF | (cm) | CL | |
|----------------------|-----------|----|--------|
| 0433651328 1 | Ø9.3x17.5 | 82 | 01/036 |
| 0730261004 | Ø9x17 | 80 | 01/024 |
| 07302610041 2 | Ø9x17 | 80 | 01/024 |

revestimento em cobre
copper coating
recubrimiento de cobre
revêtement de cuivre

**MEDIDOR**
jigger dosificador licor mesure à cocktail

| REF | (cm) | CL | |
|------------|----------------|-----|--------|
| 0431260037 | Ø4.5 Ø4.5x11.4 | 3/5 | 01/288 |

**SHAKER**
shaker coctelera shaker

| REF | (cm) | CL | |
|------------|---------|----|--------|
| 0733800011 | Ø9.7x26 | 75 | 01/020 |

**MEDIDOR NEO**
jigger dosificador licor mesure à cocktail

| REF | (cm) | CL | |
|------------|-----------|-----|--------|
| 0433659103 | Ø4.5x11.5 | 3/5 | 01/165 |

**MEDIDOR CÓNICO**
jigger dosificador licor mesure à cocktail

| REF | (cm) | CL | |
|-------------|-----------|-----|--------|
| 04312600107 | Ø5.2 Ø6x7 | 3/5 | 12/300 |

**MEDIDOR**
jigger dosificador licor mesure à cocktail

| REF | (cm) | CL | |
|------------|-------------|-----|--------|
| 0433659141 | Ø4 Ø4x9 | 3/5 | 01/100 |
| 0433659130 | Ø4 Ø3.7x7.7 | 2/4 | 01/100 |

**COADOR**
bar strainer colador de coctél passoire cocktail

| REF | (cm) | |
|------------|------|--------|
| 0431260002 | 15 | 12/288 |

**COADOR**
bar strainer colador de coctél passoire cocktail

| REF | (cm) | |
|------------|-----------|--------|
| 0433657152 | Ø9.5x20.5 | 10/100 |

**COADOR**
bar strainer colador de coctél passoire cocktail

| REF | (cm) | |
|---------------------|----------|--------|
| 0432790039 1 | Ø11.7x15 | 14/144 |
| 0432790040 2 | Ø11.7x15 | 06/144 |

**COADOR**
bar strainer colador de coctél passoire cocktail

| REF | (cm) | |
|---------------------|------|--------|
| 0433657105 1 | 16 | 01/100 |
| 0433657106 2 | 16 | 01/100 |



COADOR
bar strainer colador de coctél passoire cocktail

| REF | (cm) | |
|------------|------|--------|
| 0430685101 | 19.5 | 01/060 |



COADOR
bar strainer colador de coctél passoire cocktail

| REF | (cm) | |
|-------------|-----------|--------|
| 04327900021 | Ø9.5x20.5 | 04/072 |



COADOR
bar strainer colador de coctél passoire cocktail

| REF | (cm) | |
|----------------------|------|--------|
| 04312600085 1 | 8x16 | 01/144 |
| 0433657132 2 | 8x16 | 01/100 |



COADOR
bar strainer colador de coctél passoire cocktail

| REF | (cm) | |
|-------------|-----------|--------|
| 04327900044 | Ø7.5x15.8 | 04/120 |



BATEDOR
mixer batidor batteur

| REF | (cm) | |
|-------------|------|--------|
| 04322700012 | 20 | 00/100 |

2x AA não incluídas not included
no incluido non inclus



COLHER BAR
cocktail spoon cuchara batidora cullière à cocktail

| REF | (cm) | |
|---------------------|------|--------|
| 0433656124 1 | 40 | 24/240 |
| 0433656128 2 | 40 | 24/240 |



COLHER BAR
cocktail spoon cuchara batidora cullière à cocktail

| REF | (cm) | |
|------------|------|--------|
| 0433656144 | 30 | 24/240 |



COLHER BAR
cocktail spoon cuchara batidora cullière à cocktail

| REF | (cm) | |
|------------|------|--------|
| 0433656103 | 30 | 01/387 |



COLHER BAR
cocktail spoon cuchara batidora cullière à cocktail

| REF | (cm) | |
|------------|------|--------|
| 0433656102 | 30 | 01/200 |



COLHER BAR
cocktail spoon cuchara batidora cullière à cocktail

| REF | (cm) | |
|------------|------|--------|
| 0433940011 | 27.5 | 01/250 |



COLHER BAR
cocktail spoon cuchara batidora cullière à cocktail

| REF | (cm) | |
|------------|------|--------|
| 0433656101 | 30 | 01/200 |



COLHER BAR
cocktail spoon cuchara batidora cullière à cocktail

| REF | (cm) | |
|---------------------|------|--------|
| 0433518181 1 | 28 | 24/096 |
| 0433840001 2 | 28 | 01/096 |



COLHER BAR
cocktail spoon cuchara batidora cullière à cocktail

| REF | (cm) | |
|-------------|------|--------|
| 04312601201 | 30 | 24/600 |



COLHER DE REFERESCO
cocktail spoon cuchara batidora cullière à cocktail

| REF | (cm) | |
|------------|------|--------|
| 0433940999 | 26 | 01/500 |



PILÃO
pestle mortero pilon

| REF | (cm) | |
|------------|------|--------|
| 0432790036 | 4x24 | 03/120 |



PILÃO
pestle mortero pilon

| REF | (cm) | |
|------------|------|--------|
| 0432790003 | 21.7 | 25/250 |



PILÃO
pestle mortero pilon

| REF | (cm) | | |
|------------|------|-----------------|--------|
| 0432790002 | 1 | 21.7 | 25/250 |
| 0730260031 | 2 | 21 | 12/126 |
| 0733610072 | 21 | NOVO new | 00/000 |



ESPRESSADOR CITRINOS
citrus squeezer exprimidor para citricos presse-citron

| REF | (cm) | |
|------------|------|--------|
| 0430753024 | - | 01/012 |

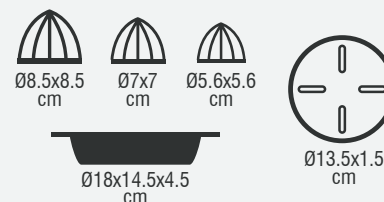

ESPRESSADOR CITRINOS
citrus squeezer exprimidor para citricos presse-citron

| REF | (cm) | |
|------------|------------|--------|
| 0432276120 | 29x16.5x41 | 01/002 |



ESPRESSADOR CITRINOS
citrus squeezer exprimidor para citricos presse-citron

| REF | (cm) | | |
|------------|------|---------|--------|
| 0432790007 | 1 | Ø7x19.5 | 04/048 |
| 0431260003 | 2 | 10.5x16 | 12/144 |



ESPRESSADOR CITRINOS
citrus squeezer exprimidor para citricos presse-citron

| REF | (cm) | |
|-------------|----------|--------|
| 04306820011 | 13x7x1.7 | 48/144 |



ESPRESSADOR LIMÃO
lemon squeezer exprimidor limón presse-citron

| REF | (cm) | | |
|------------|------|--------|--------|
| 0733597068 | 1 | 14x4.5 | 00/001 |
| 0733341011 | 2 | 11x4.5 | 00/001 |



ESPRESSADOR LIMÃO
lemon squeezer exprimidor limón presse-citron

| REF | (cm) | | |
|------------|------|-------|--------|
| 0432276126 | 1 | Ø6x20 | 01/036 |
| 0432270000 | 2 | Ø9x23 | 01/024 |

É um acessório utilizado no bar, constituído por vários discos de plástico ou metal, para aplicar sal e açúcar ou humedecer na borda do copo. A finalidade do Glass Rimmer é assentuar a estética e realçar o sabor de um cocktail.

It is an accessory used in the bar, made up of several disks of plastic or metal, to apply salt and sugar or moisten on the edge of the glass.

The purpose of the Glass Rimmer is to enhance the aesthetics and enhance the flavor of a cocktail.

Es un accesorio utilizado en la barra, que consta de varios discos de metal o de plástico, para aplicar el azúcar o la sal y humedecer el borde de la taza.

El propósito de Glass Rimmer es estética assentuar y mejorar el sabor de un cóctel.

Il est un accessoire utilisé dans le bar, constitué de divers disques en métal ou en plastique, pour appliquer le sucre ou le sel et humidifier le bord du gobelet.

Le but de Glass Rimmer est esthétique assentuar et d'améliorer la saveur d'un cocktail.



GLASS RIMMER TREVO

glass rimmer ribeteador de copas glass rimmer - trêfle

| REF | (cm) | |
|-------------|---------|--------|
| 07302600001 | Ø15.5x7 | 02/024 |



PORTA CONDIMENTOS

condiment stands porta condimentos porte condiments

| REF | (cm) | |
|------------|------------|--------|
| 0734040291 | 40x15.5x11 | 01/006 |



□□□□□ (5x)
 compartimentos removíveis
 removable compartments
 compartimientos removibles
 compartiments amovibles

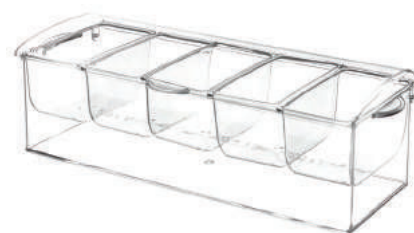

PORTA CONDIMENTOS

condiment stands porta condimentos porte condiments

| REF | (cm) | |
|------------|------------|--------|
| 0733800001 | 41x16x12.5 | 01/006 |



□□□□ (4x)
 compartimentos removíveis
 removable compartments
 compartimientos removibles
 compartiments amovibles



PORTA CONDIMENTOS

condiment stands porta condimentos porte condiments

| REF | (cm) | |
|------------|----------------|--------|
| 0731250006 | 42.2x16.7x12.5 | 01/004 |



□□□□□ (5x)
 compartimentos removíveis
 removable compartments
 compartimientos removibles
 compartiments amovibles



PORTA CONDIMENTOS

condiment stands porta condimentos porte condiments

| REF | (cm) | |
|------------|--------------|--------|
| 0731252382 | 49.5x14.5x14 | 01/006 |

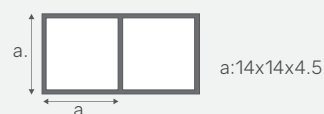

□□□ (3x)
 compartimentos removíveis
 removable compartments
 compartimientos removibles
 compartiments amovibles



PORTA CONDIMENTOS
condiment stands porta condimentos porte condiments

| REF | (cm) | |
|-------------|---------------|--------|
| 07302600041 | 49.5x15.5x9.5 | 01/012 |

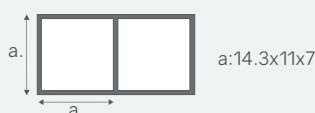

□□□□ (4x)
compartimentos removíveis
removable compartments
compartimientos removibles
compartiments amovibles



PORTA CONDIMENTOS
condiment stands porta condimentos porte condiments

| REF | (cm) | |
|-------------|--------------|--------|
| 07302600031 | 58.5x15.5x17 | 01/006 |

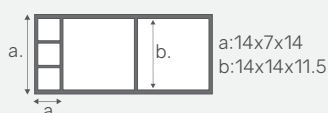

□□□□□ (3+2x)
compartimentos removíveis
removable compartments
compartimientos removibles
compartiments amovibles



PORTA CONDIMENTOS
condiment stands porta condimentos porte condiments

| REF | (cm) | |
|------------|---------|--------|
| 0433900004 | 31x15x9 | 01/012 |

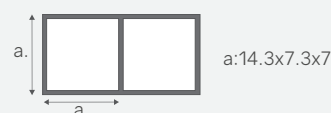

□□□□ (4x)
compartimentos removíveis
removable compartments
compartimientos removibles
compartiments amovibles



PORTA CONDIMENTOS
condiment stands porta condimentos porte condiments

| REF | (cm) | |
|-------------|---------------|--------|
| 07302600061 | 49.5x15.5x9.5 | 01/012 |

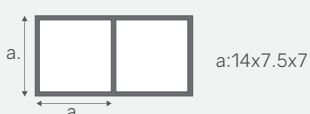

□□□□□□ (6x)
compartimentos removíveis
removable compartments
compartimientos removibles
compartiments amovibles



PORTA CONDIMENTOS
condiment stands porta condimentos porte condiments

| REF | (cm) | |
|-------------|--------------|--------|
| 07302600062 | 58.5x15.5x17 | 01/006 |

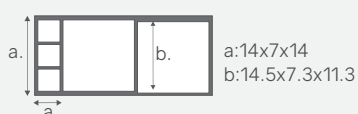

□□□□□□□ (6+2x)
compartimentos removíveis
removable compartments
compartimientos removibles
compartiments amovibles



PORTA CONDIMENTOS
condiment stands porta condimentos porte condiments

| REF | (cm) | |
|-------------|---------|--------|
| 04339000061 | 45x15x9 | 01/012 |

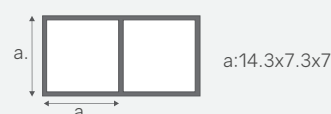

□□□□□□ (6x)
compartimentos removíveis
removable compartments
compartimientos removibles
compartiments amovibles





ANILHA ANTI-GOTA

wine drip collar anillo antigoteo anneau anti-gouttes

| REF | (cm) | |
|------------|------|--------|
| 0432270025 | Ø4x2 | 50/100 |



ROLHA UNIVERSAL P/CHAMPANHE

boffe stopper tapon universal bouchon universel

| REF | (cm) | |
|-------------|--------|--------|
| 04329300012 | Ø3.8x6 | 50/200 |



BOMBA VÁCUO P/VINHO

vacuum sealer bomba manual vacio pompe à vide

| REF | (cm) | |
|-------------|------|--------|
| 04329300082 | 14.5 | 01/050 |

com duas rolhas with two caps
con dos tapones avec deux bouchons



SACA ROLHAS D/BANCADA

countertop corkscrew sacacorchos tire-bouchon

| REF | (cm) | |
|------------|------|--------|
| 0419360002 | 54 | 01/006 |



SACA-ROLHAS

corkscrew sacacorchos tire-bouchon

| REF | (cm) | |
|-------------|------|--------|
| 04322702051 | 17 | 25/050 |



SACA-ROLHAS

corkscrew sacacorchos tire-bouchon

| REF | (cm) | |
|------------|------|-------------|
| 0432270305 | 1 | 13.5 25/100 |
| 0433870015 | 2 | 13.5 12/144 |
| 0432270037 | 3 | 13.5 30/120 |



SACA-ROLHAS 2 NÍVEIS

corkscrew sacacorchos tire-bouchon

| REF | (cm) | |
|------------|------|-----------|
| 0433871041 | 1 | 12 01/025 |
| 0433878090 | 2 | 12 01/025 |
| 0430751218 | | 12 01/120 |



SACA-ROLHAS + CANIVETE

corkscrew sacacorchos tire-bouchon

| REF | (cm) | |
|------------|------|--------|
| 0733610745 | 11 | 01/400 |
| 0430721005 | 11 | 12/144 |

inox polido polished stainless steel
acero inoxidable pulido inox poli



TIRA CÁPSULAS

foil cutter descápsulador décapsuleur

| REF | (cm) | |
|------------|------|--------|
| 0431260006 | 11 | 06/060 |





TIRA CÁPSULAS

foil cutter descápsulador décapsuleur

| REF | (cm) | |
|------------|------|--------|
| 0432790013 | 13.3 | 24/144 |



TIRA CÁPSULAS ESPALMADO

foil cutter descápsulador décapsuleur

| REF | (cm) | |
|-------------|------|--------|
| 04307544352 | 17.7 | 50/150 |
| 04312600211 | 10 | 12/432 |



TIRA CÁPSULAS ESPALMADO

foil cutter descápsulador décapsuleur

| REF | (cm) | |
|------------|------|--------|
| 0432790041 | 18 | 00/000 |
| 0432790042 | 18 | 00/000 |



TIRA CÁPSULAS ESPALMADO

foil cutter descápsulador décapsuleur

| REF | (cm) | |
|------------|------|--------|
| 0433657652 | 18 | 01/100 |
| 0433657653 | 18 | 01/196 |



TIRA CÁPSULAS ESPALMADO

foil cutter descápsulador décapsuleur

| REF | (cm) | |
|------------|------|--------|
| 0432790021 | 18 | 12/144 |



TIRA CÁPSULAS ESPALMADO

foil cutter descápsulador décapsuleur

| REF | (cm) | |
|-------------|------|---------|
| 07302600003 | 18 | 12/048 |
| 07302600004 | 18 | 12/048 |
| 07302600005 | 18 | 12/0486 |



DEPÓSITO P/CÁPSULAS

cap depository depósito para corchos dépôt pour capsules

| REF | (cm) | |
|-------------|-------------|--------|
| 04312600076 | 13.5x8x23.5 | 01/024 |



SUPORTE P/6 GARRAFAS

bottle holder soporte para botellas porte-bouteilles

| REF | (cm) | |
|------------|--------------|--------|
| 0433651306 | 56x10.5x16.5 | 01/008 |



SUPORTE P/10 GARRAFAS

bottle holder soporte para botellas porte-bouteilles

| REF | (cm) | |
|------------|---------------|--------|
| 0433651310 | 107x10.5x15.8 | 01/004 |



GANCHOS P/SUPORTE GARRAFAS

hook for bottle holder
ganchos para soporte para botellas
crochet pour porte-bouteilles

| REF | (cm) | |
|------------|------|--------|
| 0431260009 | 26 | 00/060 |



INOX

revestimento em cobre
copper coating
recubrimiento de cobre
revêtement de cuivre

CANECA CERVEJA
beer mug jarro de cerveza chope à bière

| REF | (cm) | CL | |
|------------|-----------|----|--------|
| 0433655305 | Ø8.5x10.5 | 50 | 04/048 |



INOX

revestimento em cobre
copper coating
recubrimiento de cobre
revêtement de cuivre

CANECA CERVEJA
beer mug jarro de cerveza chope à bière

| REF | (cm) | CL | |
|------------|----------|----|--------|
| 0431269014 | Ø7.8x8.5 | 40 | 01/096 |



INOX

revestimento em cobre
copper coating
recubrimiento de cobre
revêtement de cuivre

CANECA CERVEJA
beer mug jarro de cerveza chope à bière

| REF | (cm) | CL | |
|------------|--------|----|--------|
| 0432655301 | Ø8x8.5 | 40 | 01/048 |



INOX

**NOVO
new**

parede dupla
double wall
doble pared
paroi double

CANECA CERVEJA
beer mug jarro de cerveza chope à bière

| REF | (cm) | CL | |
|------------|------|----|--------|
| 0432270005 | - | 45 | 01/050 |



INOX

**NOVO
new**

CANECA CERVEJA
beer mug jarro de cerveza chope à bière

| REF | (cm) | CL | |
|------------|------|----|--------|
| 0432270010 | - | 55 | 01/048 |



INOX

parede dupla
double wall
doble pared
paroi double

CANECA CERVEJA
beer mug jarro de cerveza chope à bière

| REF | (cm) | CL | |
|------------|-------|----|--------|
| 0432270011 | Ø8x12 | 50 | 01/050 |



INOX

COPO
cup vaso fassé

| REF | (cm) | CL | |
|------------|--------|------|--------|
| 0432439998 | Ø7.7x9 | 32.5 | 01/120 |

PC

JARRO CANELADO
jug jarro pichet

| REF | (cm) | LT | |
|------------|----------|------|--------|
| 0730260601 | Ø13x21 | 1.8 | 12/060 |
| 0733610080 | Ø13x19.5 | 1.8 | 01/024 |
| 0730260602 | Ø8.3x18 | 1.4 | 12/024 |
| 0733610081 | Ø8.3x18 | 1.4 | 01/024 |
| 0730260603 | Ø11x7 | 0.95 | 12/024 |
| 0733610082 | Ø7.5x15 | 0.95 | 01/024 |



PC

JARRO CÔNICO CANELADO
conical jug jarro cónico pichet conique

| REF | (cm) | LT | |
|------------|------|--------|------------|
| 0430947699 | 1 | Ø14x23 | 1.6 01/012 |
| 0732090606 | 2 | Ø13x22 | 1.6 01/012 |





CAIXA DRENO
drain box caja de drenaje bac récepteur

| REF | (cm) | |
|------------|----------|--------|
| 0431261363 | 34x15x10 | 01/020 |



TULHA P/BORRA DE CAFÉ
coffee grounds box granero de café molido frappez boîte

| REF | (cm) | |
|-------------|------------|--------|
| 04306830011 | Ø11.3x12.2 | 01/012 |



TAPETE BALCÃO
drip map tapete escurridor tapis de bar

| REF | (cm) | |
|------------|------------|--------|
| 0733610048 | 59.5x8x1.7 | 00/000 |



TAPETE BALCÃO
drip map tapete escurridor tapis de bar

| REF | (cm) | |
|------------|---------|--------|
| 0733610049 | 45x31x1 | 01/012 |



SUPORTE ROTATIVO
routing holder soporte giratório support rotatif

| REF | (cm) | |
|------------|----------------------|--------|
| 0430750063 | Ø24x49 3x3cl + 3x5cl | 01/002 |

suporte rotativo com medidores
rotating holder with measurements
soporte giratorio con medidores
support rotatif avec mesureurs



6 garrafas
6 bottles
6 botellas
6 bouteilles



MEDIDOR
measuring equipment medidor doseur

| REF | (cm) | CL | |
|------------|---------|----|--------|
| 0432270030 | Ø0.8x12 | 3 | 50/100 |
| 0432270050 | Ø0.8x12 | 3 | 50/100 |



SUPORTE P/COPOS
cups stand soporte de copas support à coupes

| REF | (cm) | |
|------------|------|--------|
| 0433651140 | 40 | 01/024 |



VERTEDOR
spout vertedor verseur

| REF | (cm) | |
|-------------|------|--------|
| 04312600201 | 12 | 10/100 |



VERTEDOR C/RESPIRADOR
spout vertedor verseur

| REF | (cm) | |
|------------|------|--------|
| 0431260085 | 11 | 06/288 |
| 0431260099 | - | 06/288 |
| 0432790051 | - | 10/040 |



VERTEDOR C/TAMPA
spout vertedor verseur

| REF | (cm) | |
|------------|------|--------|
| 0431260220 | 11.5 | 10/100 |



VERTEDOR C/TAMPA
spout vertedor verseur

| REF | (cm) | |
|------------|------|--------|
| 0433650320 | - | 00/000 |



VERTEDOR VINHO + ROLHA
spout for wine + lid
vertedor del vino + tapa
verseur pour le vin + bouchon

| REF | (cm) | |
|------------|------|--------|
| 0432270022 | 11.5 | 50/100 |



DOSEADOR TIPO CO-RECT
bottle doser dosificador de botella doseur de bouteille

| REF | (cm) | CL | |
|------------|------|------|----------|
| 0430723000 | 1 | 00.6 | 3 12/360 |
| 0430725001 | 2 | 00.6 | 5 12/360 |



VERTEDOR
spout vertedor verseur

| REF | (cm) | | |
|-------------|----------|--|--------|
| 0431260000 | Ø0.4x7.5 | | 12/240 |
| 04307210062 | Ø0.4x7.5 | | 12/240 |



VERTEDOR
spout vertedor verseur

| REF | (cm) | | |
|------------|------|----------|--------|
| 0730269996 | 1 | Ø0.3x8.6 | 01/024 |
| 0730269995 | 2 | Ø0.3x8.6 | 01/024 |



GARRAFA C/VERTEDOR
bottle botella bouteille

| REF | (cm) | LT | |
|------------|-----------|-----|--------|
| 0730260003 | Ø8.5x30 | 1 | 01/048 |
| 0730260002 | Ø8.5x23.5 | 0.5 | 01/080 |



GARRAFA C/VERTEDOR
bottle botella bouteille

| REF | (cm) | LT | |
|-------------|---------|----|--------|
| 07302600021 | Ø8.5x32 | 2 | 01/040 |



GARRAFA "FLAIR" FBA
bottle botella bouteille

| REF | (cm) | LT | |
|------------|------|-----|--------|
| 0730261001 | 29 | 0.5 | 04/024 |



INOX

BANDEJA
serving tray bandeja camarero plateau

| REF | (cm) | |
|------------|---------|--------|
| 0433650430 | Ø30x1.5 | 01/025 |



INOX

BANDEJA
serving tray bandeja camarero plateau

| REF | (cm) | |
|------------|---------|--------|
| 0433650701 | Ø40x1.7 | 01/015 |



INOX

BANDEJA
serving tray bandeja camarero plateau

| REF | (cm) | |
|-------------|-------|--------|
| 04312600166 | Ø40x2 | 01/050 |
| 04312690142 | Ø36x2 | 01/050 |
| 04312690123 | Ø30x2 | 01/050 |
| 0433650720 | Ø40x2 | 01/015 |



INOX

BANDEJA
serving tray bandeja camarero plateau

| REF | (cm) | |
|-------------|------|--------|
| 04324300351 | Ø35 | 01/024 |
| 04309721051 | Ø30 | 00/048 |



INOX

BANDEJA
serving tray bandeja camarero plateau

| REF | (cm) | |
|-------------|---------|--------|
| 04336507351 | Ø35x2.5 | 01/025 |

revestimento em vinil vinyl coating
revestimiento en vinilo revêtement de vinyle



PP

BANDEJA
serving tray bandeja camarero plateau

| REF | (cm) | |
|------------|-------|--------|
| 0730372201 | Ø41.6 | 01/030 |
| 0730372202 | Ø35.8 | 01/030 |



BANDEJA ANTIDERRAPANTE
non-slip tray bandeja antideslizante platea antidérapant

| REF | (cm) | |
|-------------|------|--------|
| 0432930004 | Ø46 | 01/012 |
| 07336100151 | Ø40 | 01/012 |
| 0733610014 | Ø36 | 01/012 |
| 0430722014 | Ø36 | 01/052 |

NOVO
new

BANDEJA ANTIDERRAPANTE
non-slip tray bandeja antideslizante platea antidérapant

| REF | (cm) | |
|------------|-------|--------|
| 0433900991 | Ø35.5 | 01/024 |
| 0433900992 | Ø41 | 01/024 |



INOX

BANDEJA FUNDA
serving tray bandeja camarero plateau

| REF | (cm) | |
|------------|--------|--------|
| 0432930025 | Ø433x5 | 01/010 |

antiderrapante revistida em folha de alumínio escovado
non-slip with brushed aluminum foil coating
antideslizante revestida en lámina de aluminio pulido
antidérapant revêtu avec feuille en aluminium brossé



INOX

CAMPAINHA BALCÃO
reception call bell
campanilla de recepción
sonnette de réception

| REF | (cm) | |
|------------|-------|--------|
| 0434070401 | Ø10x7 | 01/120 |



ABS

ORGANIZER BALCÃO
bar caddy organizador de mesón organisateur de comptoir

| REF | (cm) | |
|------------|--------------|--------|
| 0733610024 | 23.5x13x10.5 | 05/010 |



ABS

revestimento em cobre
copper coating
recubrimiento de cobre
revêtement de cuivre

ORGANIZER Balcão
bar caddy organizador de mesón organisateur de comptoir

| REF | (cm) | |
|------------|--------------|--------|
| 0733997442 | 24x14.7x10.5 | 01/024 |



INOX

PORTA PALHINHAS
straw holder porta pajitas porte pailles

| REF | (cm) | |
|------------|---------|--------|
| 0430683301 | Ø8.5x12 | 12/036 |



INOX

COPO P/PALHINHAS
straw holder porta pajitas porte pailles

| REF | (cm) | |
|------------|--------|--------|
| 0433656537 | Ø7x9.5 | 06/048 |



INOX

DISPENSADOR PALHINHAS
straw holder porta pajitas porte pailles

| REF | (cm) | |
|------------|----------|--------|
| 0431261066 | 25x15x15 | 01/008 |



INOX

PORTA GUARDANAPOS
napkin holder servilletero distributeur de serviettes

| REF | (cm) | |
|-------------|-----------|--------|
| 04327900031 | 12.5x12.5 | 10/048 |



INOX

PORTA GUARDANAPOS TIPO L
napkin holder servilletero distributeur de serviettes

| REF | (cm) | |
|-------------|-------------|--------|
| 0733610222 | 10x12x14 | 01/012 |
| 04324300011 | 10x9.3x12.5 | 01/012 |



INOX

PORTA GUARDANAPOS TIPO L
napkin holder servilletero distributeur de serviettes

| REF | (cm) | |
|------------|-------------|--------|
| 0433980001 | 10.5x9.5x14 | 01/024 |



PORTA GUARDANAPOS
napkin holder servilletero distributeur de serviettes

| REF | (cm) | |
|---------------------|----------|--------|
| 0731280030 1 | 16x11x10 | 01/024 |
| 0731280031 2 | 16x11x10 | 01/024 |



PORTA GUARDANAPOS
napkin holder servilletero distributeur de serviettes

| REF | (cm) | |
|---------------------|--------------|--------|
| 0731280053 1 | 16x11x10 | 01/024 |
| 0731280097 2 | 16x11.2x16.5 | 01/024 |



ACRÍLICO
ACRYLIC
ACRILICO
ACRYLIQUE

PORTA GUARDANAPOS
napkin holder servilletero distributeur de serviettes

| REF | (cm) | |
|------------|---------------|--------|
| 0733639052 | 17.7x19.4x6.4 | 01/024 |
| 0733639053 | 17x15.7x6.4 | 01/012 |



PORCELANA
PORCELAIN
PORCELANA
PORCELAINE

BULE C/FILTRO
tea pot tetera théière

| REF | (cm) | LT | |
|-------------|------|------|--------|
| 0210760629 | Ø13 | 1 | 01/012 |
| 02107606291 | Ø12 | 0.51 | 01/024 |



PORCELANA
PORCELAIN
PORCELANA
PORCELAINE

BULE
tea pot tetera théière

com filtro no bico
with filter in beak
con filtro en pico
avec filtre dans le bec

| REF | (cm) | LT | |
|------------|----------|------|--------|
| 0233740001 | Ø13.5x12 | 0.75 | 01/012 |



PORCELANA
PORCELAIN
PORCELANA
PORCELAINE

BULE
tea pot tetera théière

| REF | (cm) | LT | |
|------------|----------|-----|--------|
| 0230760011 | Ø11x12.5 | 0.6 | 00/024 |



PORCELANA
PORCELAIN
PORCELANA
PORCELAINE

BULE C/FILTRO
tea pot with filter tetera con filtro théière avec filtre

| REF | (cm) | LT | |
|------------|------------|-----|--------|
| 0230760013 | Ø13.5x10.5 | 0.6 | 00/024 |



FERRO IRON HIERRO FER

BULE C/FILTRO
tea pot with filter tetera con filtro théière avec filtre

| REF | (cm) | LT | |
|------------|----------|-----|--------|
| 0432270047 | Ø14x11.5 | 0.8 | 01/008 |

INTERIOR ESMALTADO ENAMELED INTERIOR
INTERIOR ESMALTADO INTERIEUR ÉMAILLÉ



VIDRO GLASS VIDRIO VERRE
INOX
PP

BULE C/DIFUSOR
tea pot with diffuser tetera con difusor théière avec diffuseur

| REF | (cm) | LT | |
|------------|------------|------|--------|
| 0332990951 | Ø9.6x11.3 | 0.7 | 01/012 |
| 0332990095 | Ø13.5x13.7 | 1.25 | 01/012 |



VIDRO GLASS VIDRIO VERRE
INOX
PP

BULE C/DIFUSOR
tea pot with diffuser tetera con difusor théière avec diffuseur

| REF | (cm) | LT | |
|------------|------------|-----|--------|
| 0332990091 | Ø11.2x15.3 | 1.5 | 01/012 |



VIDRO GLASS VIDRIO VERRE
INOX

BULE C/DIFUSOR
tea pot with diffuser tetera con difusor théière avec diffuseur

| REF | (cm) | LT | |
|-------------|---------|-----|--------|
| 04322708111 | Ø6.7x12 | 1 | 01/012 |
| 0432270811 | Ø6.3x9 | 0.6 | 01/012 |



VIDRO GLASS VIDRIO VERRE
PLÁSTICO plastic

BULE C/DIFUSOR
tea pot with diffuser tetera con difusor théière avec diffuseur

| REF | (cm) | LT | |
|-------------|--------|------|--------|
| 0430752029 | Ø14x16 | 1.25 | 01/036 |
| 04307500032 | Ø11x14 | 0.75 | 01/048 |



BULES
tea pots
teteras
théières

pg. 138-139





INOX

BULE OVAL
oval tea pot tetera ovalada théière ovale

| REF | (cm) | LT | |
|------------|--------|-----|--------|
| 0433989114 | Ø9x9 | 0.4 | 01/036 |
| 0430680403 | Ø8.5x9 | 0.6 | 01/036 |

INOX

CAFETEIRA OVAL
coffee pot cafetera cafetière

| REF | (cm) | LT | |
|------------|-------|------|--------|
| 0430680302 | Ø7x10 | 0.6 | 01/036 |
| 0433989012 | Ø8x10 | 0.35 | 00/000 |

INOX

AÇUCAREIRO OVAL
sugar bowl azucarero sucrier

| REF | (cm) | LT | |
|------------|--------|-----|--------|
| 0430685032 | Ø8.3x9 | 0.6 | 00/072 |



INOX

BULE PREMIUM
tea pot tetera théière

| REF | (cm) | LT | |
|------------|-------|-----|--------|
| 0433900506 | Ø9x13 | 0.6 | 01/023 |

INOX

LEITEIRA
milk jug lechera laitière

| REF | (cm) | LT | |
|------------|--------|------|--------|
| 0433904035 | Ø7.5x9 | 0.35 | 01/024 |



INOX

CAFETEIRA LINHA DIREITA
coffee pot cafetera cafetière

| REF | (cm) | LT | |
|-------------|------------|-----|--------|
| 04306813061 | Ø12.5x18.5 | 2 | 01/020 |
| 04306813041 | Ø9x13 | 1 | 01/050 |
| 0433981132 | Ø8x13.5 | 0.6 | 01/050 |

INOX

BULE LINHA DIREITA
tea pot tetera théière

| REF | (cm) | LT | |
|------------|----------|------|--------|
| 0433981034 | Ø11x11.5 | 1 | 00/000 |
| 0433981031 | Ø10x10 | 0.6 | 01/050 |
| 0433981038 | Ø8.2x8.5 | 0.35 | 00/000 |
| 0430681201 | Ø7.5x6.5 | 0.35 | 01/050 |

INOX

CAFETEIRA
coffee pot cafetera cafetière

| REF | (cm) | LT | |
|------------|----------|----|--------|
| 0430680705 | Ø11.3x18 | 2 | 01/020 |



INOX

CAFETEIRA
coffee pot cafetera cafetière

| REF | (cm) | LT | |
|------------|----------|----|--------|
| 0433983172 | Ø14x20.5 | 2 | 00/000 |

INOX

CAFETEIRA
coffee pot cafetera cafetière

| REF | (cm) | LT | |
|------------|--------|----|--------|
| 0433651585 | Ø12x21 | 3 | 01/006 |

INOX

CAFETEIRA
coffee pot cafetera cafetière

| REF | (cm) | LT | |
|------------|------------|-----|--------|
| 0433890002 | Ø11.5x17.8 | 1.5 | 01/060 |



INOX

LEITEIRA
milk jug lechera laitière

| REF | (cm) | LT | |
|-------------|----------|------|--------|
| 0430722048 | Ø12x16 | 1.5 | 01/036 |
| 0733610043 | Ø11x17 | 1 | 01/020 |
| 07336100411 | Ø8.6x13 | 1 | 01/050 |
| 07336100401 | Ø7.5x11 | 0.6 | 01/050 |
| 0433901035 | Ø7.5x9.2 | 0.35 | 01/050 |
| 0733610038 | Ø5.5x8 | 0.25 | 01/100 |

INOX

LEITEIRA
milk jug lechera laitière

| REF | (cm) | LT | |
|------------|---------|--------|--------|
| 0733610133 | Ø10.3x6 | ** 1.5 | 01/050 |

** antiaderente non-stick antiaderente antiadhésif



INOX

LEITEIRA
milk jug lechera laitière

| REF | (cm) | LT | |
|------------|----------|-----|--------|
| 0433989350 | Ø12x15.5 | 1.5 | 01/024 |



INOX

revestimento em cobre
copper coating
recubrimiento de cobre
revêtement de cuivrePÚCARO
jug jarra pot

| REF | (cm) | LT | |
|-------------|------|------|--------|
| 04312600167 | Ø9x9 | 0.48 | 01/048 |
| 04312690143 | Ø9x8 | 0.42 | 01/048 |

INOX

PÚCARO
jug jarra pot

| REF | (cm) | LT | |
|-------------|--------|------|-------------|
| 04336501551 | 1 | Ø8 | 0.27 01/072 |
| 0433650155 | Ø7 | 0.2 | 01/072 |
| 04336501552 | 2 | Ø9x9 | 0.4 01/072 |
| 0432430007 | Ø7.8x8 | 0.2 | 01/120 |

INOX

SUPORTE P/ EMBALAGEM LEITE
milk carton holder soporte para envase de leche
support pour pack de lait

| REF | (cm) | |
|------------|-----------|--------|
| 0431116022 | 14.5x7x20 | 01/024 |

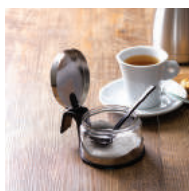
VIDRO
GLASS
VIDRIO
VERRE

INOX

AÇUCAREIRO
sugar bowl azucarero sucrier

| REF | (cm) | CL | |
|------------|----------|----|--------|
| 0430683001 | Ø9.5x7.5 | 20 | 01/060 |

açucareiro com colher sugar bowl with spoon
azucarero con cuchara sucrier avec cuillère

INOX

AÇUCAREIRO
sugar bowl azucarero sucrier

| REF | (cm) | CL | |
|-------------|-----------|----|--------|
| 04312600108 | Ø11.5x7.5 | 60 | 12/036 |

INOX

INFUSOR CHÁ
tea infuser infusor de té thé infuseur

| REF | (cm) | |
|------------|------|---------------|
| 0433870160 | 1 | 16x3.5 01/144 |
| 0433878004 | 2 | Ø5x18 01/144 |



INOX

INFUSOR CHÁ ALICATE
tea infuser infusor de té thé infuseur

| REF | (cm) | |
|------------|---------|--------|
| 0433870169 | Ø3.5x11 | 01/025 |



INOX

BOLA DIFUSORA CHÁ
tea infuser infusor de té thé infuseur

| REF | (cm) | |
|------------|------|--------|
| 0430750012 | Ø5 | 01/048 |

INOX

COADOR
tea strainer colador de té passoire à thé

| REF | (cm) | |
|-------------|----------|--------|
| 04307544801 | Ø5.5x2.4 | 24/144 |

INOX

FILTRO P/ CHÁ
tea filter filtro para té filtre pour thé

| REF | (cm) | |
|------------|----------|--------|
| 0433876021 | Ø8.8x7.5 | 01/048 |



CAIXA P/CHÁ/AÇÚCAR
tea / sugar bag box
caja para envases de té/azucar
boîte pour sachets de thé/sucre

| REF | (cm) | |
|------------|---------|--------|
| 0733638325 | 16x16x8 | 01/024 |

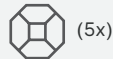

(5x)
compartimentos removíveis
removable compartments
compartimientos removibles
compartiments amovibles



CAIXA P/CHÁ/AÇÚCAR
tea / sugar bag box
caja para envases de té/azucar
boîte pour sachets de thé/sucre

| REF | (cm) | |
|------------|-------------|--------|
| 0730830339 | 27.5x17x8.5 | 01/015 |



(8x)
compartimentos removíveis
removable compartments
compartimientos removibles
compartiments amovibles



CAIXA P/CHÁ/AÇÚCAR
tea / sugar bag box
caja para envases de té/azucar
boîte pour sachets de thé/sucre

| REF | (cm) | |
|------------|--------------|--------|
| 0733638319 | 16.6x8.2x7.5 | 01/048 |



(2x)
compartimentos removíveis
removable compartments
compartimientos removibles
compartiments amovibles



CAIXA P/CHÁ/AÇÚCAR
tea / sugar bag box
caja para envases de té/azucar
boîte pour sachets de thé/sucre

| REF | (cm) | |
|------------|-------------|--------|
| 0430947006 | 23.5x9x11.5 | 01/012 |



(3x)
compartimentos removíveis
removable compartments
compartimientos removibles
compartiments amovibles



CAIXA P/CHÁ/AÇÚCAR
tea / sugar bag box
caja para envases de té/azucar
boîte pour sachets de thé/sucre

| REF | (cm) | |
|------------|-----------|--------|
| 0733638326 | 19x13x8.5 | 01/036 |



(4x)
compartimentos removíveis
removable compartments
compartimientos removibles
compartiments amovibles



CAIXA P/CHÁ/AÇÚCAR
tea / sugar bag box
caja para envases de té/azucar
boîte pour sachets de thé/sucre

| REF | (cm) | |
|------------|---------|--------|
| 1133710027 | 23x16x8 | 01/012 |



(3x)
compartimentos removíveis
removable compartments
compartimientos removibles
compartiments amovibles



CAIXA P/CHÁ/AÇÚCAR
tea / sugar bag box
caja para envases de té/azucar
boîte pour sachets de thé/sucre

| REF | (cm) | |
|------------|-----------|--------|
| 1133710003 | 31x17.5x8 | 01/012 |



(8x)
compartimentos removíveis
removable compartments
compartimientos removibles
compartiments amovibles



INOX

revestimento em cobre
copper coating
recubrimiento de cobre
revêtement de cuivre

CINZEIRO D'ÁGUA
ashtray cenicero cendrier

| REF | (cm) | |
|------------|---------|--------|
| 0433658132 | Ø10x5.5 | 12/048 |



INOX

CINZEIRO D'ÁGUA
ashtray cenicero cendrier

| REF | (cm) | |
|------------|-------|--------|
| 0433658195 | Ø11x7 | 01/072 |



1



2

INOX

CINZEIRO D'ÁGUA
ashtray cenicero cendrier

| REF | (cm) | |
|------------|------|----------------|
| 0433658191 | 1 | Ø11x6.3 01/048 |
| 0432430011 | 2 | Ø11x7 01/060 |



INOX

CINZEIRO D'ÁGUA
ashtray cenicero cendrier

| REF | (cm) | |
|------------|--------|--------|
| 0433847711 | Ø9.5x3 | 01/048 |



INOX

CINZEIRO D'ÁGUA
ashtray cenicero cendrier

| REF | (cm) | |
|------------|-------|--------|
| 0733610343 | Ø11x4 | 01/050 |



INOX

CINZEIRO
ashtray cenicero cendrier

| REF | (cm) | |
|-------------|-------|--------|
| 04324300015 | 11x11 | 01/288 |



PORCELANA
PORCELAIN
PORCELAINA
PORCELAINE

CINZEIRO ÁGUA TOP
ashtray cenicero cendrier

| REF | (cm) | |
|------------|-----------|--------|
| 0231420035 | Ø10.5x6.5 | 01/072 |



1



2

PORCELANA
PORCELAIN
PORCELAINA
PORCELAINE

CINZEIRO D'ÁGUA
ashtray cenicero cendrier

| REF | (cm) | |
|------------|------|----------------|
| 0230468796 | 1 | Ø10x8 01/072 |
| 0232748027 | 2 | Ø11x6.2 01/036 |



PORCELANA
PORCELAIN
PORCELAINA
PORCELAINE

CINZEIRO REDONDO
ashtray cenicero cendrier

| REF | (cm) | |
|------------|---------|--------|
| 0220030104 | Ø17x5.5 | 02/036 |



PORCELANA
PORCELAIN
PORCELANA
PORCELAINE

CINZEIRO TRIANGULAR
ashtray cenicero cendrier

| REF | (cm) | |
|------------|------|--------|
| 0220060009 | 14x4 | 01/096 |



PORCELANA
PORCELAIN
PORCELANA
PORCELAINE

CINZEIRO RETANGULAR
ashtray cenicero cendrier

| REF | (cm) | |
|-------------|---------|--------|
| 0220480117 | 20x17x3 | 06/048 |
| 02200200632 | 14x12x3 | 01/048 |



PORCELANA
PORCELAIN
PORCELANA
PORCELAINE

CINZEIRO QUADRADO
ashtray cenicero cendrier

| REF | (cm) | |
|------------|---------|--------|
| 0220050133 | 18x18x3 | 01/036 |



NOVO
new

PORCELANA
PORCELAIN
PORCELANA
PORCELAINE

CINZEIRO EMPILHÁVEL TOP
ashtray cenicero cendrier

| REF | (cm) | |
|------------|-----------|--------|
| 0231420999 | Ø10.5x3.1 | 01/144 |

empilhável
stackable
apilable
empilable



1



2

VIDRO
GLASS
VIDRIO
VERRE

CINZEIRO BISTRO
ashtray cenicero cendrier

| REF | (cm) | |
|-------------|-------------|--------|
| 03315940363 | 1 Ø10.5x3.5 | 02/012 |
| 0331594126 | 2 Ø7.2x3.5 | 01/024 |

empilhável
stackable
apilable
empilable



VIDRO
GLASS
VIDRIO
VERRE

CINZEIRO REDONDO
ashtray cenicero cendrier

| REF | (cm) | |
|------------|-----------|--------|
| 0333471105 | Ø10.5x3.5 | 01/072 |

empilhável
stackable
apilable
empilable



VIDRO
GLASS
VIDRIO
VERRE

CINZEIRO RECTANGULAR
ashtray cenicero cendrier

| REF | (cm) | |
|------------|------------|--------|
| 0331595020 | 18.5x9x3.5 | 01/006 |



MELAMINA
melamine

CINZEIRO QUADRADO
ashtray cenicero cendrier

| REF | (cm) | |
|------------|-----------|--------|
| 0432930005 | 14x14x3.5 | 01/200 |



1

2

MELAMINA
melamine

CINZEIRO D'ÁGUA
ashtray cenicero cendrier

| REF | (cm) | |
|-------------|-----------|--------|
| 07325601052 | 1 Ø10x4.5 | 30/120 |
| 07325601053 | 2 Ø10x4.5 | 30/120 |





descartáveis *disposable*
desechable *jetable*



EMBALAGEM
package embalaje emballage



PET **PACK 50**

COPO
glass vaso verre

| REF | (cm) | CL | |
|------------|-------------|----|--------|
| 0733701084 | 1 Ø8.4x10.4 | 30 | 50/020 |
| 0733701284 | Ø8.4x10.8 | 36 | 50/020 |

TAMPA
lid tapa couverture

| | | | |
|-------------|--------|--|--------|
| 0733700084 | 2 Ø8.4 | | 50/020 |
| 07337000841 | 3 Ø8.4 | | 50/020 |



PET **PACK 50**

COPO
glass vaso verre

| REF | (cm) | CL | |
|------------|-----------|------|--------|
| 0733700978 | 1 Ø7.8x10 | 27.5 | 50/020 |

TAMPA
lid tapa couverture

| | | | |
|-------------|--------|--|--------|
| 0733700078 | 2 Ø7.8 | | 50/020 |
| 07337000781 | 3 Ø7.8 | | 50/020 |



PET **PACK 50**

COPO
glass vaso verre

| REF | (cm) | CL | |
|------------|----------|----|--------|
| 0733701698 | 1 Ø10x12 | 50 | 50/020 |

TAMPA
lid tapa couverture

| | | | |
|-------------|--------|--|--------|
| 0733700098 | 2 Ø9.8 | | 50/020 |
| 07337000981 | 3 Ø9.8 | | 50/020 |



PP

COPO
glass vaso verre

| REF | (cm) | CL | |
|------------|---------|----|--------|
| 0732785773 | Ø8.1x11 | 30 | 01/040 |

PACK 50

PS

COPO SHOT AFERIDO 2CL
wine glass vaso de vino verre de vin

| REF | (cm) | CL | |
|------------|--------|----|--------|
| 0732785768 | Ø3.9x4 | 3 | 01/050 |



PACK 50



COPO PAPEL
glass vaso verre

| REF | (cm) | CL | |
|------------|------------|----|--------|
| 1533720035 | 1 Ø5.5x5.5 | 8 | 01/040 |
| 1533720008 | Ø8x9.5 | 28 | 01/020 |
| 1533720010 | Ø8x11.6 | 30 | 01/020 |

TAMPA
lid tapa couverture

| | | | |
|-------------|------|--|--------|
| 15337200081 | 2 Ø8 | | 01/020 |
|-------------|------|--|--------|



COPO TÉRMICO

termic cup vaso térmico gobelet thermique

| REF | (cm) | CL | |
|------------|-------------|------|--------|
| 1533864002 | 1 Ø8x12.8x5 | 35 | 01/050 |
| 1533863003 | 2 Ø8x9x4.8 | 23.7 | 01/040 |

TAMPA

lid tapa couverture

| | | | |
|------------|------|--|--------|
| 1533861000 | 3 Ø8 | | 01/012 |
|------------|------|--|--------|



PACK 25



COPO D/CARTÃO DUPLO CANELADO

glass vaso verre

| REF | (cm) | CL | |
|------------|----------|----|--------|
| 1533720081 | 1 Ø8x9.5 | 29 | 01/020 |

TAMPA

lid tapa couverture

| | | | |
|-------------|------|--|--------|
| 15337200811 | 2 Ø8 | | 01/020 |
|-------------|------|--|--------|



EMBALAGEM C/TAMPA

box with lid evase con tapa boite avec couvercle

| REF | (cm) | CL | |
|------------|------------|----|--------|
| 0732590032 | 1 Ø12x13.5 | 95 | 50/500 |
| 0737885388 | 2 Ø12x10 | 65 | 50/600 |
| 0732590016 | 3 Ø12x6.5 | 47 | 50/500 |



EMBALAGEM C/TAMPA

box with lid evase con tapa boite avec couvercle

| REF | (cm) | CL | |
|------------|---------------|----|--------|
| 0732590500 | 1 17.5x12x3.5 | 45 | 50/500 |
| 0737885483 | 2 17.5x12x7 | 95 | 50/400 |
| 0737885485 | 3 17.5x12x5.3 | 65 | 50/400 |



PACK 300



EMBALAGEM C/TAMPA

box with lid evase con tapa boite avec couvercle

| REF | (cm) | CL | |
|------------|-----------------|----|--------|
| 0732590729 | 1 Ø18.3x5.5 | 87 | 50/300 |
| 0732590868 | 2 22x15x4 | 60 | 50/300 |
| 0732590828 | 3 18.6x15.8x6.6 | 75 | 50/300 |



descartáveis disposable desechable /etable



EMBALAGEM

package embalaje emballage



PACK 12

PS

CHÁVENA

coffee cup / taza de café / tasse de café

| REF | (cm) | CL | |
|------------|------|----|--------|
| 0732785776 | Ø7x6 | 20 | 01/024 |



1



2

PS

PACK 50

TAÇA SOBREMESA

dessert bowl / cuencos de postre / bols à dessert

| REF | (cm) | CL | |
|------------|---------|------|--------|
| 0732783390 | Ø10x4.8 | 21.5 | 01/012 |

TAMPA

lid / tapa / couverture

| | | | |
|------------|---------|--|--------|
| 0732783390 | Ø10x2.6 | | 01/012 |
|------------|---------|--|--------|



PS

PACK 4

COLHER SERVIR

spoon / cuchara / cuillère

| REF | (cm) | |
|------------|------|--------|
| 0732787748 | 22.8 | 01/048 |



PS

PACK 4

GARFO SERVIR

fork / tenedor / fourchette

| REF | (cm) | |
|------------|------|--------|
| 0732787749 | 22.8 | 01/048 |



PACK 24

PS

MINI GARFO

mini forks / mini tenedores / mini fourchette

| REF | (cm) | |
|------------|------|--------|
| 0732783388 | 10.6 | 01/048 |



PS

PACK 1000

COLHER GELADO

spoon / cuchara / cuillère

| REF | (cm) | |
|------------|------|--------|
| 0732788119 | 9.2 | 01/010 |



PACK 100

MISTURADORES COCKTAIL

cocktail stirrers / agitadores de coctel / agitateurs cocktail

| REF | (cm) | |
|-------------|------|--------|
| 04307200201 | 19 | 01/010 |



PACK 100

MISTURADORES COCKTAIL

cocktail stirrers / agitadores de coctel / agitateurs cocktail

| REF | (cm) | |
|------------|------|--------|
| 0934460002 | 8.5 | 01/144 |



PACK 100

MISTURADORES COCKTAIL

cocktail stirrers / agitadores de coctel / agitateurs cocktail

| REF | (cm) | |
|------------|------|--------|
| 0934460005 | 7 | 01/144 |



PACK 500



AGITADOR

coffee stirrer / agitador de café / agitateurs pour café

| REF | (cm) | |
|------------|------|--------|
| 0932628635 | 17.8 | 01/100 |



PACK 100



GARFO

buffet fork / tenedor de buffet / fourchette buffet

| REF | (cm) | |
|------------|------|--------|
| 0932620090 | 9 | 01/100 |



PACK
500



PALITOS
toothpick paliton cure-dents

| REF | (cm) | |
|------------|------|--------|
| 0932620500 | 6.5 | 01/024 |

PACK
1000



PALITOS
toothpick paliton cure-dents

| REF | (cm) | |
|--|------|--------|
| 0932626501 | 6.5 | 01/024 |
| embalados individualmente individually packed emballados individualmente emballées individuellement | | |

2x

PACK
100



PALITOS
toothpick paliton cure-dents

| REF | (cm) | |
|------------|------|--------|
| 0932621002 | 6.5 | 05/240 |

PACK
200



PALITOS
toothpick paliton cure-dents

| REF | (cm) | |
|--|------|--------|
| 09326265011 | 6.5 | 10/120 |
| embalados individualmente individually packed emballados individualmente emballées individuellement | | |

1



PACK
100

ESPETOS
skewers pinchos brochettes

| REF | (cm) | |
|------------|------|-----------|
| 1530812525 | 1 | 25 01/100 |
| 0932620240 | 2 | 24 01/050 |
| 0932620300 | | 30 01/050 |

2



PACK
100

PAUZINHOS P/POP CAKES
sticks palillos batons

| REF | (cm) | |
|-------------|------|--------|
| 1533310005 | 10 | 00/100 |
| 15333100051 | 15 | 00/100 |



PACK
25

FORMAS
baking cups capsulas repostaria caissette/pâtisserie

| REF | (cm) | |
|------------|--------|--------|
| 1533310001 | 06x4.8 | 00/048 |



PACK
10

CAIXINHAS
baking cups capsulas repostaria caissette/pâtisserie

| REF | (cm) | |
|------------|---------|--------|
| 1533310015 | 5.5x5x4 | 00/048 |



PACK
24

FORMAS TULIPA
baking cups capsulas repostaria caissette/pâtisserie

| REF | (cm) | |
|------------|------|--------|
| 1533310004 | 09x9 | 00/048 |





EMBALAGEM

package embalaje emballage



FORMAS
baking cups capsulas repostaria caissette/pâtisserie

| REF | (cm) | |
|------------|--------|--------|
| 1533310003 | Ø9x1.8 | 00/100 |



FORMAS
baking cups capsulas repostaria caissette/pâtisserie

| REF | (cm) | |
|------------|----------|--------|
| 1533310002 | Ø7.5x3.5 | 00/100 |



FORMAS
baking cups capsulas repostaria caissette/pâtisserie

| REF | (cm) | |
|------------|--------|--------|
| 0732307236 | Ø9x2.8 | 01/150 |



NAPERONS RECTANGULARES
doilies blondas napperons

| REF | (cm) | |
|------------|-------|--------|
| 1530813040 | 40x30 | 20/060 |



NAPERONS RECTANGULARES
doilies blondas napperons

| REF | (cm) | |
|-------------|-------|--------|
| 15333100141 | 40x20 | 00/008 |



NAPERONS REDONDOS
doilies blondas napperons

| REF | (cm) | |
|------------|-------|--------|
| 1530810300 | Ø30 | 20/080 |
| 1530810345 | Ø34.5 | 20/080 |
| 1530810370 | Ø37 | 20/060 |

PROTECCÃO E HIGIENE

protection and hygiene
 protección e higiene
 protection et hygiène

A limpeza numa cozinha profissional é uma característica fundamental e muito importante, para garantir o sucesso.

Para auxiliar na limpeza e protecção dos alimentos, apresentamos várias soluções descartáveis: toucas, máscaras, aventais e luvas.

Cleaning in a professional kitchen is a key and very important feature to ensure success.

To assist in the cleaning and protection of food, we offer several disposable solutions: caps, masks, aprons and gloves.

Limpieza de una cocina profesional son una característica fundamental y muy importante para asegurar el éxito.

Para ayudar en la limpieza y protección de los alimentos, se presentan varias soluciones desechables: gorras, mascarillas, batas y guantes.

Le nettoyage d'une cuisine professionnelle est un point essentiel et très important pour garantir le succès. Pour faciliter le nettoyage et la protection des aliments, nous présentons plusieurs solutions jetables: coiffes, masques, tablier et gants.



PROTECCÃO

protection protección protection



PACK 50

MÁSCARA PROTECCÃO

protection mask máscara protectora masque de protection

| REF | (cm) | |
|------------|----------|--------|
| 0731360009 | 17.5x9.5 | 02/240 |



PACK 100

TOUCA DESCARTÁVEL

disposable cap tapa desechable chapeau jetable

| REF | (cm) | |
|------------|------|--------|
| 0731360010 | 45 | 01/010 |

PACK 100 LDPE

LUVAS

gloves guantes gants

| REF | (cm) | |
|------------|------|--------|
| 0731360005 | 26 | 01/100 |

em conformidade com a norma europeia EN240
 in compliance with European standard EN240
 en cumplimiento de la norma europea EN240
 en conformité avec la norme européenne EN240

não esterilizadas
 non-sterilized
 no esterilizadas
 non stérilisé



PACK 100 LATEX

LUVAS

gloves guantes gants

| REF | Nº | |
|-------------|----|--------|
| 0733460250 | M | 12/240 |
| 07334602501 | L | 12/240 |



PACK 100 LATEX

LUVAS

gloves guantes gants

| REF | Nº | |
|-------------|----|--------|
| 0733460102 | S | 01/010 |
| 07334601021 | M | 01/010 |
| 07334601022 | L | 01/010 |
| 07334601023 | XL | 01/010 |



PACK 100

AVENTAL

apron delantales tabliers

| REF | (cm) | GR | |
|--|--------|----|--------|
| 0731360004 | 80x125 | 10 | 01/010 |
| 18 microns 18 microns 18 micras 18 microns | | | |



descartáveis disposable /jetable



To stop toasting, red-cock,
just lift up the carriage control lever

DRINK MACHINE

HIGH PERFORMANCE COMMERCIAL TECHNOLOGY

TEMPERATURE SELECTION
POWER SWITCH
HEAT LIGHT



equipamentos equipments
equipamientos équipements



Equipamentos

equipments equipamientos équipements

293



PROCESSADORES DE ALIMENTOS

food processors procesadores de alimentos processeurs alimentaires

300



CONFECÇÃO

confection confección confection

308



CONSERVAÇÃO & EXPOSIÇÃO

conservation and exhibition conservación y exposición conservation et exposition

314



EQUIPAMENTOS PARA COZINHA

kitchen equipment equipos para cocina équipement de cuisine

NOVO
new

319



PROTECÇÃO

protection protección protection



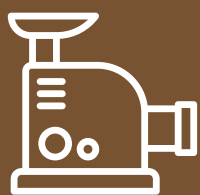

PROCESSADORES DE ALIMENTOS

food processors

procesadores de alimentos

processeurs alimentaires





PROCESSADORES DE ALIMENTOS

food processors procesadores de alimentos processeurs alimentaires



ESPREMEDOR DE CITRINOS
citrus juicer exprimidor de citricos press-citroen

| REF | (cm) | |
|------------|----------|--------|
| 1332380006 | 28x20x47 | 01/001 |

MODELO model modelo modèle **CJ6**
ROTAÇÕES rotations rotaciones rotations **980RPM**
PESO weight peso poids **10.5KG**
VOLTAGEM voltage voltaje voltage **220/240V**
FREQUÊNCIA frequency frecuencia fréquence **50/60HZ**
POTÊNCIA power potencia puissance **230W**



ESPREMEDOR DE CITRINOS
citrus juicer exprimidor de citricos press-citroen

| REF | (cm) | |
|------------|----------------|--------|
| 1332380005 | 33.5x20.2x47.5 | 01/001 |

MODELO model modelo modèle **CJ6A**
ROTAÇÕES rotations rotaciones rotations **1800RPM**
PESO weight peso poids **8KG**
VOLTAGEM voltage voltaje voltage **220/240V**
FREQUÊNCIA frequency frecuencia fréquence **50/60HZ**
POTÊNCIA power potencia puissance **230W**



ESPREMEDOR DE CITRINOS
citrus juicer exprimidor de citricos press-citroen

| REF | (cm) | |
|-------------|--------------|--------|
| 13303800081 | 21x24.6x40.6 | 01/001 |

MODELO model modelo modèle **CS-Z8**
ROTAÇÕES rotations rotaciones rotations **1500RPM**
PESO weight peso poids **15.2KG**
VOLTAGEM voltage voltaje voltage **220/230/240V**
FREQUÊNCIA frequency frecuencia fréquence **50/60HZ**
POTÊNCIA power potencia puissance **180W**



BLENDER/LIQUIDIFICADOR
blender mezcladora/licuadora mixeur/blender

| REF | (cm) | LT |
|------------|----------|----|
| 1332389020 | 21x23x52 | 2 |

MODELO model modelo modèle **O20B (PRO)-E**
ROTAÇÕES rotations rotaciones rotations **2800RPM**
PESO model modelo modèle **5.5KG**
VOLTAGEM voltage voltaje voltage **230V**
FREQUÊNCIA frequency frecuencia fréquence **50HZ**
POTÊNCIA power potencia puissance **1500W**



BLENDER/LIQUIDIFICADOR
blender mezcladora/licuadora mixeur/blender

| REF | (cm) | LT |
|------------|----------|----|
| 1332380008 | 20x25x50 | 2 |

MODELO model modelo modèle **BL-008**
ROTAÇÕES rotations rotaciones rotations **2800RPM**
VOLTAGEM voltage voltaje voltage **220/240V**
FREQUÊNCIA frequency frecuencia fréquence **50/60HZ**
POTÊNCIA power potencia puissance **1000W**



BLENDER/LIQUIDIFICADOR
blender mezcladora/licuadora mixeur/blender

| REF | (cm) | LT |
|------------|----------|----|
| 1332389000 | 20x23x49 | 2 |

MODELO model modelo modèle **BL-X**
ROTAÇÕES rotations rotaciones rotations **2800RPM**
PESO weight peso poids **5.5KG**
VOLTAGEM voltage voltaje voltage **220/240V**
FREQUÊNCIA frequency frecuencia fréquence **50/60HZ**
POTÊNCIA power potencia puissance **1500W**

equipamentos equipments equipamientos equipments



BLENDER/LIQUIDIFICADOR
blender mezcladora/licuadora mixeur/blender

| REF | (cm) | LT | |
|------------|------------|----|--------|
| 1332380020 | 20x23x43.2 | 2 | 01/001 |

MODELO model modelo modèle **BL-020B**
ROTAÇÕES rotations rotaciones rotations **2800RPM**
VOLTAGEM voltage voltaje voltage **220/240V**
FREQUÊNCIA frequency frecuencia fréquence **50/60HZ**
POTÊNCIA power potencia puissance **1500W**

- reduz em 80%, o ruído do blender
- serve para amortecer o som dos liquidificadores
- as dobradiças de fricção resistentes suportam a tampa em qualquer posição
- os pés em ventosa fixam a caixa ao balcão e impedem o balanço
- fácil de arrumar e limpar

- reduces by 80%, the noise of the blender
- serves to dampen the sound of the blenders
- heavy-duty friction hinges support the hood in any position
- the suction cup feet secure the box to the counter and prevent the swing
- easy to pack and clean

- reducido en un 80%, el ruido de la batidora
- sirve para amortiguar lo sonido de mezcladores
- las bisagras de fricción resistentes mantienen la capota en cualquier posición
- los pies en ventosa fijan la caja al balcón y previenen el oscilación
- fácil de guardar y limpiar

- réduit de 80%, le bruit du mixeur
- il sert à amortir les mélangeurs sonores
- les charnières de friction tenaces soutiennent le capot dans n'importe quelle position
- les pieds de ventouse fixent l'unité au comptoir et empêchent le balancement
- facile à stocker et nettoyer



CAIXA INSONORIZAÇÃO P/ BLENDER

blenders sound enclosures
caja de aislamiento acústico para blenders
boîte d'insonorisation pour blender

| REF | (cm) | |
|------------|--------------|--------|
| 1332380022 | 41x27.4x56.3 | 01/001 |

- motor com rolamento de esferas
- para uso comercial, motor pode trabalhar em contínuo durante 9h
- base pesada para manter o equipamento estável
- eixo de mistura e copo em aço inoxidável, cabeça de mistura em PC aprovado para uso alimentar

- will ball bearing motor
- commercial motor which can run over 9 hours without stop in one time
- heavy base to keep the machine steady, s/s blending axis and jug, PC mixing head, confirms to food sanitation

- motor con rodamiento de bolas
- para uso comercial, motor puede trabajar en continuo durante 9h
- base pesada para mantener el equipo estable
- eje de mezcla y vaso de acero inoxidable, cabeza de mezcla en PC aprobado para uso alimentario

- moteur à roulement à billes
- pour un usage commercial, le moteur peut fonctionner continu pendant 9 heures
- base lourde pour maintenir le matériel stable
- arbre mélangeur et coupelle en acier inoxydable, tête de mélange pour PC approuvée pour un usage alimentaire



MISTURADOR DE BEBIDAS
drink mixer mezclador de bebidas mélangeur de boisson

| REF | (cm) | |
|------------|--------------|--------|
| 1332389912 | 20.8x15.8x50 | 01/001 |

MODELO model modelo modèle **DM-A**
POTÊNCIA power potencia puissance **400W**



ESPRESSADOR DE CITRINOS
citrus juicer exprimidor de cítricos press-citroen

| REF | (cm) | LT | |
|------------|----------|----|--------|
| 1334140003 | 40x30x78 | 2 | 01/001 |

MODELO model modelo modèle **2000E-3**
PESO weight peso poids **50KG**
PRODUÇÃO production producción production **20PCS/MIN.**
VOLTAGEM voltage voltaje voltage **220V/110V**
FREQUÊNCIA frequency frecuencia fréquence **50/60HZ**
POTÊNCIA power potencia puissance **120W**



PROCESSADORES DE ALIMENTOS

food processors procesadores de alimentos processeurs alimentaires



INOX **NOVO**
new

AMASSADEIRA
kneader amasadora pétrisseur

| REF | (cm) | LT | |
|------------|-------------|----|--------|
| 1334140030 | 85x56x98 ** | 30 | 01/001 |



MODELO model modelo modèle **BMS30T**

PESO weight peso poids **98KG**

CAPACIDADE (CUBA) capacity (bowl) capacidad (taza) capacité (tasse) **30L**

CAPACIDADE (MASSA) capacity (dough) capacidad (masa) capacité (masse) **12kg**

VELOCIDADE (MISTURA) speed (mixing) velocidad (mezcla) vitesse (mélange) **105/158RPM/MIN.**

VOLTAGEM voltage voltaje voltage **220V**

FREQUÊNCIA frequency frecuencia fréquence **50HZ**

POTÊNCIA power potencia puissance **1500W**



INOX

AMASSADEIRA
kneader amasadora pétrisseur

| REF | (cm) | LT | |
|------------|--------------|-----|--------|
| 1330383130 | 122.2x75x143 | 130 | 01/001 |



MODELO model modelo modèle **HS130**

PESO weight peso poids **695KG**

CAPACIDADE (CUBA) capacity (bowl) capacidad (taza) capacité (tasse) **130L**

CAPACIDADE (MASSA) capacity (dough) capacidad (masa) capacité (masse) **50kg**

VELOCIDADE (MISTURA) speed (mixing) velocidad (mezcla) vitesse (mélange) **107/210RPM**

VELOCIDADE (CUBA) speed (bowl) velocidad (taza) vitesse (tasse) **16RPM**

VOLTAGEM voltage voltaje voltage **380V**

FREQUÊNCIA frequency frecuencia fréquence **50/60HZ**

POTÊNCIA power potencia puissance **5600W**



INOX **NOVO**
new

BATEDEIRA
blender batidora mixeur

| REF | (cm) | LT | |
|------------|---------------|----|--------|
| 1334140015 | 55x50x71 * | 15 | 01/001 |
| 1334140020 | 53x49.6x78 ** | 20 | 01/001 |



* **MODELO** model modelo modèle **ST-15K**

PESO weight peso poids **61KG**

CAPACIDADE (CUBA) capacity (bowl) capacidad (taza) capacité (tasse) **20L**

CAPACIDADE (MASSA) capacity (dough) capacidad (masa) capacité (masse) **3kg**

VELOCIDADE (MISTURA) speed (mixing) velocidad (mezcla) vitesse (mélange) **110/178/355RPM/MIN.**

VOLTAGEM voltage voltaje voltage **220V/3-380V**

FREQUÊNCIA frequency frecuencia fréquence **50HZ**

POTÊNCIA power potencia puissance **500W**

** **MODELO** model modelo modèle **ST-20K**

PESO weight peso poids **87KG**

CAPACIDADE (CUBA) capacity (bowl) capacidad (taza) capacité (tasse) **20L**

CAPACIDADE (MASSA) capacity (dough) capacidad (masa) capacité (masse) **4kg**

VELOCIDADE (MISTURA) speed (mixing) velocidad (mezcla) vitesse (mélange) **104/187/358RPM/MIN.**

VOLTAGEM voltage voltaje voltage **220V/3-380V**

FREQUÊNCIA frequency frecuencia fréquence **50HZ**

POTÊNCIA power potencia puissance **1100W**



INOX **NOVO**
new

BATEDEIRA
blender batidora mixeur

| REF | (cm) | LT | |
|------------|----------------|----|--------|
| 1334140007 | 41.2x23.5x43 * | 7 | 01/001 |



MODELO model modelo modèle **ST-7L**

PESO weight peso poids **22KG**

CAPACIDADE (CUBA) capacity (bowl) capacidad (taza) capacité (tasse) **7L**

CAPACIDADE (MASSA) capacity (dough) capacidad (masa) capacité (masse) **0.4kg**

VELOCIDADE (MISTURA) speed (mixing) velocidad (mezcla) vitesse (mélange) **780/MIN.**

VOLTAGEM voltage voltaje voltage **220V**

FREQUÊNCIA frequency frecuencia fréquence **50HZ**

POTÊNCIA power potencia puissance **350W**



BATEDEIRA
blender batidora mixeur

| REF | (cm) | LT | |
|------------|----------------|--------|--------|
| 1333501001 | 42.6x31.6x66.6 | * 10 | 01/001 |
| 1333501002 | 43.9x32.8x70 | ** 15 | 01/001 |
| 1333501003 | 54x41.5x76.3 | *** 20 | 01/001 |

*** MODELO** model modelo modèle **JSMX-01**

CAPACIDADE (CUBA) capacity (bowl) capacidad (taza) capacité (tasse) **10L**
VELOCIDADE (MISTURA) speed (mixing) velocidad (mezcla) vitesse (mélange) **193/377RPM**
VOLTAGEM voltage voltaje voltage **220V**
FREQUÊNCIA frequency frecuencia fréquence **60HZ**
POTÊNCIA power potencia puissance **370W**

**** MODELO** model modelo modèle **JSMX-02**

CAPACIDADE (CUBA) capacity (bowl) capacidad (taza) capacité (tasse) **15L**
VELOCIDADE (MISTURA) speed (mixing) velocidad (mezcla) vitesse (mélange) **193/377RPM**
VOLTAGEM voltage voltaje voltage **220V**
FREQUÊNCIA frequency frecuencia fréquence **60HZ**
POTÊNCIA power potencia puissance **370W**

*****MODELO** model modelo modèle **JSMX-03**

CAPACIDADE (CUBA) capacity (bowl) capacidad (taza) capacité (tasse) **20L**
VELOCIDADE (MISTURA) speed (mixing) velocidad (mezcla) vitesse (mélange) **94/165/386RPM**
VOLTAGEM voltage voltaje voltage **220V**
FREQUÊNCIA frequency frecuencia fréquence **60HZ**
POTÊNCIA power potencia puissance **750W**



BATEDEIRA
blender batidora mixeur

| REF | (cm) | LT | |
|------------|--------------|----|--------|
| 1332100007 | 41x20.5x39.5 | 7 | 01/001 |

MODELO model modelo modèle **HLB-7**

PESO weight peso poids **13KG**
CAPACIDADE (CUBA) capacity (bowl) capacidad (taza) capacité (tasse) **7L**
CAPACIDADE (MASSA) capacity (dough) capacidad (masa) capacité (masse) **0.8kg**
VELOCIDADE (MISTURA) speed (mixing) velocidad (mezcla) vitesse (mélange) **350RPM**
VOLTAGEM voltage voltaje voltage **220V**
FREQUÊNCIA frequency frecuencia fréquence **50HZ**
POTÊNCIA power potencia puissance **0.8KW**



PICADORA 123
grinder picadora hachoir

| REF | (cm) | |
|------------|----------|--------|
| 1331060303 | 37x23x22 | 01/001 |

MODELO model modelo modèle **SCP-303**

PESO weight peso poids **2KG**
CAPACIDADE capacity capacidad capacité **200GR**
ROTAÇÕES rotations rotaciones rotations **10.000RPM**
VOLTAGEM voltage voltaje voltage **220V**
FREQUÊNCIA frequency frecuencia fréquence **50HZ**
POTÊNCIA power potencia puissance **0.45KW**



NOVO
new

PICADORA
grinder picadora hachoir

| REF | (cm) | |
|------------|-------------------|--------|
| 1332380081 | 44.38x27.02x50.58 | 01/001 |

MODELO model modelo modèle **G81**

PESO weight peso poids **24.5KG**
CAPACIDADE capacity capacidad capacité **230KG/H**
VELOCIDADE (LÂMINA) speed (blade) velocidad (lámina) vitesse (lame) **200RPM**
POTÊNCIA power potencia puissance **800W**

10 horas de trabalho contínuo com alta estabilidade
 continuum work 10 hours with high stability
 10 horas de trabajo contínuo con alta estabilidad
 10 heures de travail continu avec une grande stabilité



PROCESSADORES DE ALIMENTOS

food processors procesadores de alimentos proceseurs alimentaires



INOX

PICADORA
grinder picadora hachoir

| REF | (cm) | | |
|------------|----------------|----|--------|
| 1332100012 | 60.2x45.4x26.2 | * | 01/001 |
| 1332100021 | 60.2x45.4x26.2 | ** | 01/001 |

* **MODELO** model modelo modèle **HM-12**

PESO weight peso poids **24KG**

PRODUÇÃO production producción production **120KG/H**

VOLTAGEM voltage voltaje voltage **220/230V**

FREQUÊNCIA model modelo modèle **60HZ**

POTÊNCIA power potencia puissance **0.85KW**

1 lâmina/1 disco 5/8mm 1 blade/1 disc 5/8mm
1 lâmina/1 disco 5/8mm 1 lame/1 disque 5/8mm

** **MODELO** model modelo modèle **HM-22A**

PESO weight peso poids **26.5KG**

PRODUÇÃO production producción production **300KG/H**

VOLTAGEM voltage voltaje voltage **220/230V**

FREQUÊNCIA model modelo modèle **60HZ**

POTÊNCIA power potencia puissance **1.1KW**

2 lâminas/3 discos 5/6/10mm 2 blades/3 discs 5/6/10mm
2 lâminas/3 discos 5/6/10mm 2 lames/3 disques 5/6/10mm



INOX

PICADORA
grinder picadora hachoir

| REF | (cm) | |
|------------|------------|--------|
| 1332380053 | 42x18.7x44 | 01/001 |

MODELO model modelo modèle **G53**

PESO weight peso poids **6KG**

PRODUÇÃO production producción production **75KG/H**

VOLTAGEM voltage voltaje voltage **220V**

FREQUÊNCIA model modelo modèle **50HZ**

POTÊNCIA power potencia puissance **1.2KW**

lacado branco white lacquered
lacado branco laque blanc



INOX

SERRA OSSOS
bone cutting machine aserrador de huesos scie à os

| REF | (cm) | |
|------------|--------------|--------|
| 1332101650 | 46.5x43.7x86 | 01/001 |

MODELO model modelo modèle **HLS-1650**

PESO weight peso poids **42KG**

DIMENSÕES MESA table dimensions

dimensiones mesa dimensiones de table **46.5x43.7CM**

DIÂMETRO DA SERRA saw diameter diámetro de sierra

diamètre scie **Ø21CM**

VOLTAGEM voltage voltaje voltage **230V**

FREQUÊNCIA model modelo modèle **50HZ**

POTÊNCIA power potencia puissance **0.75KW**



INOX

FATIADORA VEGETAIS/ENCHIDOS
sausage/vegetables slicer

rebanadora hortalizas/embutidos
francheuse légumes/saucisses

| REF | (cm) | |
|------------|----------------|--------|
| 1331060228 | 20.5x18.5x32.5 | 01/001 |

MODELO model modelo modèle **SW-22B**

VOLTAGEM voltage voltaje voltage **220/240V**

FREQUÊNCIA frequency frecuencia fréquence **50/60HZ**

POTÊNCIA power potencia puissance **130W**



INOX

CORTADORA D/VEGETAIS
vegetable cutter cortador de verduras coupe-légumes

| REF | (cm) | |
|------------|--------------|--------|
| 1330380023 | 27.5x58x45.5 | 01/001 |

MODELO model modelo modèle **MFC23**

PESO weight peso poids **30KG**

CAPACIDADE capacity capacidad capacité **15KG**

DISCOS discs discos disques **Ø20.4CM**

PRODUÇÃO production producción production **120KG/H**

VOLTAGEM voltage voltaje voltage **220V**

FREQUÊNCIA frequency frecuencia fréquence **50HZ**

POTÊNCIA power potencia puissance **500W**

8 discos 8 discs 8 discos 8 disques



INOX

NOVO
new

CE

DESCASCADORA D/BATATAS
potato peeler pelador de patatas éplucheur de pommes

| REF | (cm) | |
|-------------|------|-----------|
| 13341400151 | - | * 01/001 |
| 13341400301 | - | ** 01/001 |

* **MODELO** model modelo modèle **TP15**

PESO weight peso poids **94KG**

CAPACIDADE capacity capacidad capacité **15KG**

PRODUÇÃO production producción production **227R/MIN.**

VOLTAGEM voltage voltaje voltage **220V**

FREQUÊNCIA frequency frecuencia fréquence **50HZ**

POTÊNCIA power potencia puissance **1100W**

** **MODELO** model modelo modèle **TP30**

PESO weight peso poids **105KG**

CAPACIDADE capacity capacidad capacité **30KG**

PRODUÇÃO production producción production **227R/MIN.**

VOLTAGEM voltage voltaje voltage **220V**

FREQUÊNCIA frequency frecuencia fréquence **50HZ**

POTÊNCIA power potencia puissance **2000W**



AL **NOVO**
new

LAMINADOR D/GELO
ice laminator molino dehielo tranche glaçons

| REF | (cm) | |
|------------|----------|--------|
| 1332380777 | 42x21x43 | 01/001 |

MODELO model modelo modèle **IC-777**
PESO weight peso poids **8KG**
PRODUÇÃO production producción production **65KG/H**
ROTAÇÕES rotations rotaciones rotations **1400RPM**
VOLTAGEM voltage voltaje voltage **220V**
FREQUÊNCIA frequency frecuencia fréquence **50HZ**
POTÊNCIA power potencia puissance **250W**



INOX

MÁQUINA GELO (CUBOS)
ice cubes maker máquina de hacer cubitos de hielo
machine à glaçons

| REF | (cm) | |
|------------|----------|--------|
| 1334000020 | 38x45x60 | 01/024 |

MODELO model modelo modèle **ZB-20**
CAPACIDADE capacity capacidad capacité **8KG**
PRODUÇÃO production producción production **20KG/24H**
VOLTAGEM voltage voltaje voltage **110V**
FREQUÊNCIA frequency frecuencia fréquence **60HZ**
POTÊNCIA power potencia puissance **170W**



INOX

MÁQUINA GELO
ice cubes maker máquina de hacer cubitos de hielo
machine à glaçons

| REF | (cm) | |
|------------|------------|--------|
| 1330380015 | 35.5x40x43 | 01/001 |

MODELO model modelo modèle **ZB-15**
PESO weight peso poids **17KG**
PRODUÇÃO production producción production **9-12KG/24H**
CILINDRO cylinder cilindro cylindre **1.8KG**
VOLTAGEM voltage voltaje voltage **220V**
FREQUÊNCIA frequency frecuencia fréquence **50HZ**
POTÊNCIA power potencia puissance **0.15KW**

INOX

MÁQUINA GELO (CUBOS)
ice cubes maker
máquina de hacer cubitos de hielo
machine à glaçons

| REF | (cm) | | |
|------------|--------------|-----|--------|
| 1334000040 | 50.5x57x78 | * | 01/020 |
| 1334000060 | 61x65.6x96 | ** | 01/005 |
| 1334000090 | 71.5x65.6x96 | *** | 01/005 |

*** MODELO** model modelo modèle **ZBF-40E**
CAPACIDADE capacity capacidad capacité **10KG**
PRODUÇÃO production producción production **45-43KG/24H**
VOLTAGEM voltage voltaje voltage **240V**
FREQUÊNCIA frequency frecuencia fréquence **50HZ**
POTÊNCIA power potencia puissance **360/380W**

**** MODELO** model modelo modèle **ZBF-60**
CAPACIDADE capacity capacidad capacité **28KG**
PRODUÇÃO production producción production **62-56KG/24H**
VOLTAGEM voltage voltaje voltage **240V**
FREQUÊNCIA frequency frecuencia fréquence **50HZ**
POTÊNCIA power potencia puissance **400/420W**

***** MODELO** model modelo modèle **ZB-90**
CAPACIDADE capacity capacidad capacité **34KG**
PRODUÇÃO production producción production **102-94KG/24H**
VOLTAGEM voltage voltaje voltage **240V**
FREQUÊNCIA frequency frecuencia fréquence **50HZ**
POTÊNCIA power potencia puissance **740/760W**



AL **PLÁSTICO** **NOVO**
new **CE**

MÁQUINA GELO
ice cubes maker máquina de hacer cubitos de hielo
machine à glaçons

| REF | (cm) | |
|------------|----------|--------|
| 1334140188 | 37x29x56 | 01/001 |

MODELO model modelo modèle **WF-B188**
PESO weight peso poids **16KG**
PRODUÇÃO production producción production **80KG/H**
VELOCIDADE speed velocidad vitesse **1440R/MIN.**
CILINDRO cylinder cilindro cylindre **1.8KG**
VOLTAGEM voltage voltaje voltage **110/220V**
FREQUÊNCIA frequency frecuencia fréquence **50/60HZ**
POTÊNCIA power potencia puissance **250W**



CONFECÇÃO

confection confección confection

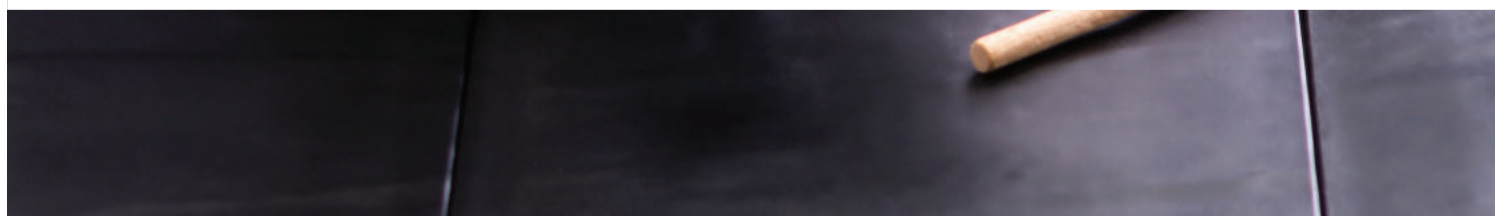



CHAPA
grill plancha plaque

| REF | (cm) | |
|------------|--------------|--------|
| 1330380538 | 46x27.5x28.5 | 01/001 |

MODELO model modelo modèle **LR-EG-538T**
PESO weight peso poids **16.5KG**
TEMPERATURA temperature temperatura température **50°-300°**
VOLTAGEM voltage voltaje voltage **220V**
FREQUÊNCIA frequency frecuencia fréquence **50HZ**
POTÊNCIA power potencia puissance **3KW**

rolos em inox stainless steel rolls
 rodillos de acero inoxidable rouleaux en acier inoxydable



GRELHADOR CONTACTO
contact grill grill de contacto grill panini

| REF | (cm) | | |
|-------------|------------|----|--------|
| 1332380002 | 41x30.5x21 | * | 01/001 |
| 13323800021 | 41x30.5x21 | ** | 01/001 |

*** MODELO** model modelo modèle **EG-02-C**
PESO weight peso poids **19KG**
TEMPERATURA temperature temperatura température **50°-300°**
VOLTAGEM voltage voltaje voltage **220V**
FREQUÊNCIA frequency frecuencia fréquence **50HZ**
POTÊNCIA power potencia puissance **2.2KW**

placa inferior lisa, placa superior canelada
 flat bottom plate, corrugated sheet plate
 placa de fondo plana, placa superior canelada
 plaque de fond plat, plaque supérieure ondulée

**** MODELO** model modelo modèle **EG-02-A**
PESO weight peso poids **19KG**
TEMPERATURA temperature temperatura température **50°-300°**
VOLTAGEM voltage voltaje voltage **220V**
FREQUÊNCIA frequency frecuencia fréquence **50HZ**
POTÊNCIA power potencia puissance **2.2KW**

placas caneladas
 corrugated sheets
 placas caneladas
 plaques ondulées



GRELHADOR HOT DOG
grill grill grill

| REF | (cm) | |
|-------------|----------------|--------|
| 13303800091 | 55.3x40.2x17.5 | 01/001 |

MODELO model modelo modèle **RG9 LR-HD-9**
TEMPERATURA temperature temperatura température **0°-200°**
PESO weight peso poids **12KG**
VOLTAGEM voltage voltaje voltage **220V**
FREQUÊNCIA frequency frecuencia fréquence **50HZ**
POTÊNCIA power potencia puissance **0.9KW**



GRELHADOR CONTACTO
contact grill grill de contacto grill panini

| REF | (cm) | | |
|-------------|----------|--|--------|
| 13303800021 | 49x37x26 | | 01/001 |

MODELO model modelo modèle **XSB-2**
PESO weight peso poids **19KG**
VOLTAGEM voltage voltaje voltage **220V**
FREQUÊNCIA frequency frecuencia fréquence **50HZ**
POTÊNCIA power potencia puissance **1.6KW**



MÁQUINA P/PÃO HOT DOG
machine for hot dog bread
maquina para panes hot dog
machine pour pain de hot dog

| REF | (cm) | | |
|------------|----------|--|--------|
| 1332100001 | 65x38x26 | | 01/001 |

MODELO model modelo modèle **HHD-1**
CAPACIDADE capacity capacidad capacité **4**
PESO weight peso poids **9.7KG**
VOLTAGEM voltage voltaje voltage **220V**
FREQUÊNCIA frequency frecuencia fréquence **50HZ**
POTÊNCIA power potencia puissance **0.30KW**



CONFEÇÃO

confection confección confection

1



construção geral em aço inox > grelha amovível com pega > tabuleiro aparador de migalhas > cabo de alimentação > resistência em tubo de sílica reforçada com buchas refratárias nas extremidades

stainless steel construction > removable grid with handle > crumb catcher stainless steel tray > power cord > reinforced quartz tubes resistors with refractory anchors (quartz models)

construcción en acero inoxidable > parrilla desmontable > cajón recoge migas > cable de alimentación > resistencia de tubo de cuarzo reforzados en los extremos

construction en acier inox > grille amovible avec poignée > tiroir ramasse miettes en acier inox > cordon d'alimentation > résistances sous tubes de quartz renforcées avec chevilles réfractaires aux extrémités



TORRADEIRA SILICA PREMIUM sandwich toaster tostadora toasteur

| REF | (cm) | | |
|-------------|--------------|----|--------|
| 1337933110 | 1 49x27x26.5 | * | 01/001 |
| 13379302011 | 2 49x27x37 | ** | 01/001 |

* **MODELO** model modelo modèle **31TRO10101**
PESO weight peso poids **6.7KG**
VOLTAGEM voltage voltaje voltage **230V**
FREQUÊNCIA frequency frecuencia fréquence **50HZ**
POTÊNCIA rotations rotaciones rotations **2400KW (2x3x400W)**

** **MODELO** model modelo modèle **31TRO10201**
PESO weight peso poids **8.2KG**
VOLTAGEM voltage voltaje voltage **230V**
FREQUÊNCIA frequency frecuencia fréquence **50HZ**
POTÊNCIA power potencia puissance **3600KW (3x3x400W)**

2



300 fatias/hora
300 slices/hour
300 rebanadas/tiempo
300 tranches/temps



TORRADEIRA DUPLA sandwich toaster tostadora toasteur

| REF | (cm) | |
|-------------|----------|--------|
| 13323800023 | 40x24x40 | 01/001 |

MODELO model modelo modèle **TS-02**
VOLTAGEM voltage voltaje voltage **220/240V**
FREQUÊNCIA frequency frecuencia fréquence **50HZ**
POTÊNCIA power potencia puissance **3KW**

as resistências podem funcionar separadamente
resistences can operate separately
las resistencias pueden funcionar por separad
les résistances peuvent fonctionner séparément

*200 fatias/hora
200 slices/hour
200 rebanadas/tiempo
200 tranches/temps



1



construção geral em aço inox
grelha amovível com pega
tabuleiro aparador de migalhas
resistência cromoniquel
isolamento térmico superior
interruptores bipolares
temporizador

stainless steel construction
removable grid with handle
crumb catcher stainless steel tray
top notch thermal insulation
shielded heating elements
switches indicator > timer

2



construcción en acero inoxidable
parrilla desmontable
cajón recoge migas
aislamineto térmico superior
resistencias blindadas
interruptores bipolares
temporizador

construcion en acier inox
grille amovible avec poignée
tiroir ramasse déchets en acier inox
isolement thermique supérieur
résistances blindées
interrupteurs bipolaire
timer



TORRADEIRA CROMONIQUEL C/TEMPORIZADOR sandwich toaster tostadora toasteur

| REF | (cm) | | |
|-------------|--------------|----|--------|
| 1337930102 | 1 49x27x26.5 | * | 01/001 |
| 13379301021 | 2 49x27x37 | ** | 01/001 |

* **MODELO** model modelo modèle **31TRO20102**
PESO weight peso poids **6.8KG**
VOLTAGEM voltage voltaje voltage **230V**
FREQUÊNCIA frequency frecuencia fréquence **50HZ**
POTÊNCIA power potencia puissance **2500KW (2x1x1250W)**

** **MODELO** model modelo modèle **31TRO20202**
PESO weight peso poids **8.3KG**
VOLTAGEM voltage voltaje voltage **230V**
FREQUÊNCIA frequency frecuencia fréquence **50HZ**
POTÊNCIA rotations rotaciones rotations **3750KW (3x1x1250W)**



TORRADEIRA SIMPLES sandwich toaster tostadora toasteur

| REF | (cm) | |
|-------------|------------|--------|
| 13323800003 | 61x40x28.5 | 01/001 |

MODELO model modelo modèle **TS-03**
CAPACIDADE capacity capacidad capacité **200***
VOLTAGEM voltage voltaje voltage **220/240V**
FREQUÊNCIA frequency frecuencia fréquence **50HZ**
POTÊNCIA power potencia puissance **3KW**

as resistências podem funcionar separadamente
resistences can operate separately
las resistencias pueden funcionar por separad
les résistances peuvent fonctionner séparément

*240 fatias/hora
240 slices/hour
240 rebanadas/tiempo
240 tranches/temps



TORRADEIRA ROTATIVA
sandwich toaster tostadora toasteur

| REF | (cm) | |
|------------|----------------|--------|
| 1332380000 | 36.5x41.5x38.5 | 01/001 |

MODELO model modelo modèle **EST-A MEDIUM**
CAPACIDADE capacity capacidad capacité **240***
VOLTAGEM voltage voltaje voltage **220/240V**
FREQUÊNCIA frequency frecuencia fréquence **50HZ**
POTÊNCIA power potencia puissance **1.94KW**

*300 fatias/hora
300 slices/hour
300 rebanadas/tiempo
300 tranches/temps



TORRADEIRA
sandwich toaster tostadora toasteur

| REF | (cm) | |
|------------|----------|--------|
| 1332380100 | 30x33x24 | 01/001 |

MODELO model modelo modèle **CT-100**
CAPACIDADE capacity capacidad capacité **300***
VOLTAGEM voltage voltaje voltage **220V**
FREQUÊNCIA frequency frecuencia fréquence **50HZ**
POTÊNCIA power potencia puissance **2.2KW**

permite seleccionar o número de torradas a fazer (2, 4 ou 6 peças), poupança de energia

allows you to select the number of toasts to do (2, 4 or 6 pieces), energy saving

permite seleccionar el número de tostadas a ahacer (2, 4 o 6 piezas), ahorro de energía

permet sélectionner le nombre de toasts à faire (2, 4 ou 6 pièces), économies d'énergie



TORRADEIRA
sandwich toaster tostadora toasteur

| REF | (cm) | |
|------------|--------------|--------|
| 1332380061 | 40.6x21x22.5 | 01/001 |

MODELO model modelo modèle **ETS-6A**
CAPACIDADE capacity capacidad capacité **6***
VOLTAGEM voltage voltaje voltage **220V**
FREQUÊNCIA frequency frecuencia fréquence **50HZ**
POTÊNCIA power potencia puissance **2.9KW**

*6 fatias
6 slices
6 rebanadas
6 tranches



FRITADEIRA A GÁS
fryer freidora friteuse

| REF | (cm) | |
|------------|-------------|--------|
| 1332389911 | 40x77.5x118 | 01/001 |

MODELO model modelo modèle **GEF-1**
TEMPERATURA temperature temperatura température **60°-200°**
POTÊNCIA power potencia puissance **9000BTU/Hr**



com opção: gás natural ou GPL

válvula de controlo Robertshaw importada dos EUA
pés aço ajustáveis, pegas em aço inox
queimadores verticais para uma melhor performance da chama
fornecimento do gás é cortado automaticamente logo que o piloto é desligado
acoplamentos térmicos duplos, um para o piloto, outro para o queimador principal
termostato Robertshaw
limitado de temperaturas (238°C) Robertshaw para maior segurança

with option: natural gas or LPG

Robertshaw control valve imported from USA adjustable steel feet, stainless steel handles vertical burners for better flame performance gas supply is automatically cut off as soon as the pilot is switched off
double thermal couplings, one for pilot, one for main burner Robertshaw thermostat limited temperature (238°C) Robertshaw for added safety

con opción: gas natural o GPL

válvula de control Robertshaw importada de los EUA
pies de acero ajustable, asas de acero inoxidable
quemadores verticales para un mejor rendimiento de la llama
el suministro de gas se corta automáticamente una vez que el piloto está apagado
acoplamientos térmicos dobles, uno para el piloto, otro para el quemador principal
termostato Robertshaw
limitado de temperaturas (238°C) Robertshaw para mayor seguridad

avec option: gaz naturel ou GPL

Robinet de commande Robertshaw importé des Etats-Unis
pieds en acier réglables, poignées en acier inoxydable
brûleurs verticaux pour une meilleure performance de la flamme
l'alimentation en gaz est automatiquement coupée dès que le pilote est éteint
doubles couplages thermiques, un pour le pilote, un pour le thermostat Robertshaw du brûleur principal
température limitée (238°C) Robertshaw pour plus de sécurité



CONFEÇÃO

confection confección confection



construção e resistência em aço inox
terminais faston em aço inox
cabeça desmontável para facilitar a limpeza da cuba
termostato regulável até 190°C
termostato de segurança 240°C

stainless steel construction and resistor
stainless steel fastoon terminals
lift out control panel for easy cleaning
adjustable thermostat till 190°C
safety thermostat 240°C

construcción y resistencia en acero inoxidable
cabeza desmontable para facilitar la limpieza de la cuba
terminales fastoon en acero inoxidable
termostato regulable 190°C
termostato de seguridad 240°C7

friteuse en acier inoxydable
fête démontable pour faciliter le nettoyage de la cuve
bornes de connexion Faston en acier inoxydable
thermostat réglable jusqu'à 190°C
thermostat de sécurité 240°C



FRITADEIRA TRIFÁSICA C/TORNEIRA

fryer freidora friteuse

| REF | (cm) | |
|------------|--------------|--------|
| 1337930204 | 65x49.5x34.5 | 01/001 |

MODELO model modelo modèle **31FR020204**
CAPACIDADE capacity capacidad capacité **10+10LT**
PESO weight peso poids **18KG**
VOLTAGEM voltage voltaje voltage **380V**
FREQUÊNCIA frequency frecuencia fréquence **50HZ**
POTÊNCIA power potencia puissance **7500x2W**



FRITADEIRA

fryer freidora friteuse

| REF | (cm) | |
|------------|--------------|--------|
| 1330380101 | 49x28.3x34.5 | 01/001 |

MODELO model modelo modèle **LR-EF-101V**
TEMPERATURA temperature temperatura température **30°-200°**
CAPACIDADE capacity capacidad capacité **10LT**
VOLTAGEM voltage voltaje voltage **220V**
FREQUÊNCIA frequency frecuencia fréquence **50HZ**
POTÊNCIA power potencia puissance **3KW**



1



2

3



FRITADEIRA MONOFÁSICA

fryer freidora friteuse

| REF | | (cm) | | |
|-------------|---|----------------|----|--------|
| 13379301031 | 1 | 41.5x26.5x34.5 | * | 01/001 |
| 13379301041 | 2 | 49.5x32.5x34.5 | ** | 01/001 |

*** MODELO** model modelo modèle **31FR010103**
CAPACIDADE capacity capacidad capacité **7LT**
PESO weight peso poids **7KG**
VOLTAGEM voltage voltaje voltage **230V**
FREQUÊNCIA frequency frecuencia fréquence **50HZ**
POTÊNCIA power potencia puissance **3500W**

**** MODELO** model modelo modèle **31FR020102**
CAPACIDADE capacity capacidad capacité **10LT**
PESO weight peso poids **9KG**
VOLTAGEM voltage voltaje voltage **230V**
FREQUÊNCIA frequency frecuencia fréquence **50HZ**
POTÊNCIA power potencia puissance **4500W**



FRITADEIRA TRIFÁSICA C/TORNEIRA

fryer freidora friteuse

| REF | (cm) | |
|------------|----------------|--------|
| 1337930104 | 49.5x32.5x34.5 | 01/001 |

***** MODELO** model modelo modèle **31FR020104**
CAPACIDADE capacity capacidad capacité **10LT**
PESO weight peso poids **9KG**
VOLTAGEM voltage voltaje voltage **380V**
FREQUÊNCIA frequency frecuencia fréquence **50HZ**
POTÊNCIA power potencia puissance **7500W**

construção e resistência em aço inox
terminais faston em aço inox
cabeça desmontável para facilitar a limpeza da cuba
termostato regulável até 190°C
termostato de segurança 240°C

stainless steel construction and resistor
stainless steel fastoon terminals
lift out control panel for easy cleaning
adjustable thermostat till 190°C
safety thermostat 240°C

construcción y resistencia en acero inoxidable
cabeza desmontable para facilitar la limpieza de la cuba
terminales fastoon en acero inoxidable
termostato regulable 190°C
termostato de seguridad 240°C7

friteuse en acier inoxydable
fête démontable pour faciliter le nettoyage de la cuve
bornes de connexion Faston en acier inoxydable
thermostat réglable jusqu'à 190°C
thermostat de sécurité 240°C





FRITADEIRA
fryer freidora friteuse

| REF | (cm) | |
|------------|--------------|--------|
| 1330380102 | 49x56.6x34.5 | 01/001 |

MODELO model modelo modèle **LR-EF-102V**
TEMPERATURA temperature temperatura température **30°-200°**
CAPACIDADE capacity capacidad capacité **10LT (2x)**
VOLTAGEM voltage voltaje voltage **220V**
FREQUÊNCIA frequency frecuencia fréquence **50HZ**
POTÊNCIA power potencia puissance **2x3KW**

temperatura máxima 230°C
 maximum temperature 230°C
 temperatura máxima 230°C
 température maximale 230°C



FRITADEIRA
fryer freidora friteuse

| REF | (cm) | |
|------------|----------------|--------|
| 1332100008 | 53.3x31.4x43.3 | 01/001 |

MODELO model modelo modèle **HDF-8**
TEMPERATURA temperature temperatura température **60°-190°**
CAPACIDADE capacity capacidad capacité **8LT**
VOLTAGEM voltage voltaje voltage **220V**
FREQUÊNCIA frequency frecuencia fréquence **50HZ**
POTÊNCIA power potencia puissance **3.25KW**



opção: gás natural ou GPL
 option: natural gas or GPL
 opción: gas natural o GPL
 option: gaz naturel ou GPL



FOGÃO A GÁS 6 BICOS C/FORNO
gas cooker with oven
cocina con horno
cuisinière à gaz avec four

| REF | (cm) | |
|-------------|--------------|--------|
| 13323800032 | 92x81x(90+5) | 01/001 |



FOGÃO A GÁS 4 BICOS C/FORNO
gas cooker with oven
cocina con horno
cuisinière à gaz avec four

| REF | (cm) | |
|-------------|--------------|--------|
| 13323800033 | 61x81x(90+5) | 01/001 |

função grill no topo
 função para bombear água

grill on the top
 function to pump water

function de parrilla en la parte superior
 función para bombear agua

fonction de grill en haut
 fonctionner pour pomper l'eau



FORNO CONVERTOR C/4 TABULEIROS
convection oven with 4 trays
horno convector con 4 fuentes
four convecteur avec 4 plateaux

| REF | (cm) | |
|-------------|------------|--------|
| 13323800040 | 59.5x53x57 | 01/001 |

* **MODELO** model modelo modèle **EN-40E**
PESO weight peso poids **47KG**
TABULEIROS trays fuentes plateaux **45.2x33CM**
INTERIOR FORNO
 oven interior interior horno intérieur four **46x24.5x28.5CM**
TEMPERATURA temperature temperatura température **50°-300°**
VOLTAGEM voltage voltaje voltage **110/120-220/240V**
FREQUÊNCIA frequency frecuencia fréquence **50/60HZ**
POTÊNCIA power potencia puissance **3.2+2KW**



FORNO P/PIZZA
pizza oven horno para pizza four à pizza

| REF | (cm) | |
|------------|--------------|--------|
| 1332380030 | 58.5x70x34.5 | 01/001 |

MODELO model modelo modèle **EO-30**
PESO weight peso poids **20KG**
VOLTAGEM voltage voltaje voltage **220V**
FREQUÊNCIA frequency frecuencia fréquence **50HZ**
POTÊNCIA power potencia puissance **21KW**

interior em cerâmica
dimensões do prato (pizza)

ceramic interior
plate dimensions

interior en cerámica
dimensiones de plato

intérieur dans céramique
dimensiones d'assiette 45cm



FORNO ROLANTE P/PIZZA
pizza oven horno para pizza four à pizza

| REF | (cm) | |
|------------|-------------|--------|
| 1330380001 | 138x55.5x42 | 01/001 |

MODELO model modelo modèle **HX-1**
PESO weight peso poids **47KG**
VOLTAGEM voltage voltaje voltage **220/240V**
FREQUÊNCIA frequency frecuencia fréquence **50HZ**
POTÊNCIA power potencia puissance **6.7KW**

este forno pode ser usado também para fazer pão
this oven can also be used to make bread
este horno también se puede utilizar para hacer pan
ce four peut également être utilisé pour faire du pain



Estrutura em aço inoxidável
permite uma forma saudável de preservar:
fruta, vegetais, carnes e pão...
termostato: 40°C-75°C / 105°-165°F
1,5 mt quadrados de superfície disponível
10 tabuleiros amovíveis
temporizador 12 horas
protecção contra sobre-aquecimentos

Stainless steel construction
healthy way to preserve:
fruits, meats, vegetables, herbs, breads and flowers...
thermostat: 40°C-75°C / 105°-165°F
1.5 square meters
10 removable food trays
12 hours timer
over heat protection

Estructura de acero inoxidable
permite una forma sana de preservar:
frutas, vegetales, carnes y pan...
termostato: 40°C - 75°C / 105-165°F
1,5 mt cuadrados de superficie disponible
10 bandejas extraíbles
temporizador 12 horas
protección contra sobrecalentamientos

Cadre en acier inoxydable
permet une façon saine de conserver:
les fruits, les légumes, les viandes et le pain...
thermostat: 40 ° C - 75 ° C / 105-165 ° F
1,5 mètre carré d'espace disponible
10 plateaux amovibles
Minuterie de 12 heures
protection contre la surchauffe



DESIDRATADOR DE ALIMENTOS
food dehydrator deshidratador de alimentos
deshydrateur des aliments

| REF | (cm) | |
|------------|----------------|--------|
| 1332389991 | 43.5x50.8x43.5 | 01/001 |

MODELO model modelo modèle **DF-1**
PESO weight peso poids **16.5KG**
VOLTAGEM voltage voltaje voltage **220/240 110/120V**
POTÊNCIA power potencia puissance **1KW**



CREPEIRA
crêpe maker crêpera crêpière

| REF | (cm) | |
|-------------|--------------|--------|
| 13323800011 | 45x51x23 Ø40 | 01/001 |

MODELO model modelo modèle **CM-001**
TEMPERATURA temperature temperatura température **0°-300°**
VOLTAGEM voltage voltaje voltage **220V**
FREQUÊNCIA frequency frecuencia fréquence **50HZ**
POTÊNCIA power potencia puissance **3KW**



CREPEIRA
crêpe maker crêpera crêpière

| REF | (cm) | |
|-------------|------|--------|
| 13323800031 | Ø40 | 01/020 |

MODELO model modelo modèle **CM-003**
VOLTAGEM voltage voltaje voltage **230V**
FREQUÊNCIA frequency frecuencia fréquence **50HZ**
POTÊNCIA power potencia puissance **3000W**



MÁQUINA DE WAFFLES
waffle maker gofrera gaufrier

| REF | (cm) | |
|-------------|----------|--------|
| 13303800019 | 25x43x25 | 01/001 |

MODELO model modelo modèle **LR-WB-01**
TEMPERATURA temperature temperatura température **0°-300°**
VOLTAGEM voltage voltaje voltage **220/240V**
FREQUÊNCIA frequency frecuencia fréquence **50/60HZ**
POTÊNCIA power potencia puissance **1.4KW**



MÁQUINA P/CONES
machine for making cones
máquin apara hacer conos
machine pour fair des cônes



| REF | (cm) | |
|-------------|----------------|--------|
| 13303800018 | 25x43x25 Ø21 | 01/020 |

MODELO model modelo modèle **5LR-CM-01**
TEMPERATURA temperature temperatura température **0°-300°**
VOLTAGEM voltage voltaje voltage **220/240V**
FREQUÊNCIA frequency frecuencia fréquence **50/60HZ**
POTÊNCIA power potencia puissance **1.4KW**



FORTE CHOCOLATE 3 NÍVEIS
chocolate fountain fuente de chocolate fontaine à chocolat

| REF | (cm) | |
|------------|--------------|--------|
| 0432272108 | 22.8x21.8x41 | 01/006 |

CAPACIDADE capacity capacidad capacité **1KG**
VOLTAGEM voltage voltaje voltage **220/240V**
FREQUÊNCIA frequency frecuencia fréquence **50HZ**
POTÊNCIA power potencia puissance **170W**



FORTE CHOCOLATE
chocolate fountain fuente de chocolate fontaine à chocolat

| REF | (cm) | | |
|------------|---------|-----|--------|
| 0430681311 | Ø33x68 | * | 01/010 |
| 0430681312 | Ø36x82 | ** | 01/010 |
| 0430681313 | Ø43x103 | *** | 01/020 |

*** MODELO** model modelo modèle **A11311**
CAPACIDADE capacity capacidad capacité **4KG**
PESO weight peso poids **9KG**
VOLTAGEM voltage voltaje voltage **220V**
FREQUÊNCIA frequency frecuencia fréquence **50/60HZ**
POTÊNCIA power potencia puissance **150W**

**** MODELO** model modelo modèle **A11312**
CAPACIDADE capacity capacidad capacité **6KG**
PESO weight peso poids **14KG**
VOLTAGEM voltage voltaje voltage **220V**
FREQUÊNCIA frequency frecuencia fréquence **50/60HZ**
POTÊNCIA power potencia puissance **150W**

***** MODELO** model modelo modèle **A11313**
CAPACIDADE capacity capacidad capacité **8KG**
PESO weight peso poids **14KG**
VOLTAGEM voltage voltaje voltage **220V**
FREQUÊNCIA frequency frecuencia fréquence **50/60HZ**
POTÊNCIA power potencia puissance **150W**



DISPENSADOR CHOCOLATE QUENTE
hot chocolate dispenser
dispensador de chocolate caliente
distributeur de chocolat chaud

| REF | (cm) | |
|-------------|----------|--------|
| 13323800101 | 28x41x58 | 01/006 |

MODELO model modelo modèle **CF-10**
PESO weight peso poids **14KG**
CAPACIDADE capacity capacidad capacité **10LT**
TEMP. MÁXIMA temp. max. temp.máx. temp. max. **32°C**
TEMP. MÍNIMA temp. min. temp. mín. temp. min. **10°C**
VOLTAGEM voltage voltaje voltage **220V**
FREQUÊNCIA frequency frecuencia fréquence **50HZ**
POTÊNCIA power potencia puissance **1006W**



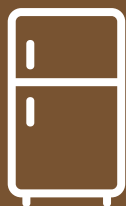

CONSERVAÇÃO & EXPOSIÇÃO

conservation and exhibition

conservación y exposición

conservation et exposition

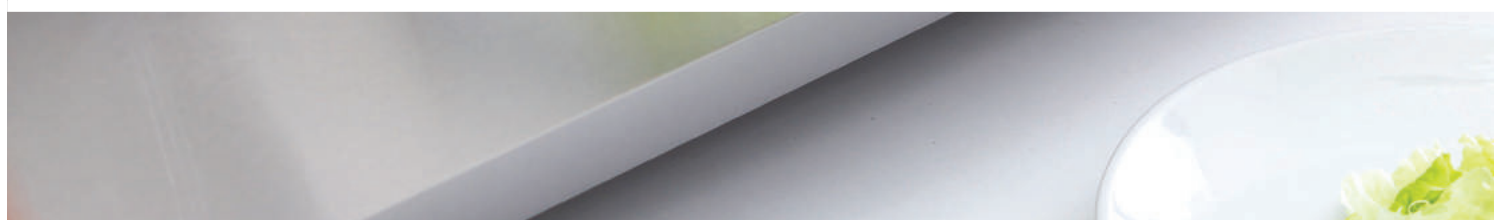



BANHO MARIA 4xGN1/2
bain marie baño maria bain-marie

| REF | (cm) | |
|-----------|----------|--------|
| 133238994 | 68x56x27 | 01/001 |

MODELO model modelo modèle **OPS-4**

PESO weight peso poids **18KG**

VOLTAGEM voltage voltaje voltage **220/240V**

FREQUÊNCIA frequency frecuencia fréquence **50/60HZ**

POTÊNCIA power potencia puissance **1.5KW**



BANHO MARIA 4xGN1/2 + 1xGN1/1
bain marie baño maria bain-marie

| REF | (cm) | |
|-----------|-----------|--------|
| 133238996 | 101x56x27 | 01/001 |

MODELO model modelo modèle **OPS-6**

PESO weight peso poids **23KG**

VOLTAGEM voltage voltaje voltage **220/240V**

FREQUÊNCIA frequency frecuencia fréquence **50/60HZ**

POTÊNCIA power potencia puissance **1.5KW**



VITRINE AQUECEDORA

food warmer display vitrina calentadora vitrine chauffante

| REF | (cm) | | |
|------------|--------------|----|--------|
| 1332380260 | 1 50x36x26 | * | 01/001 |
| 1332380395 | 2 50x36x29.5 | ** | 01/001 |

*** MODELO** model modelo modèle **SW-260**

PESO weight peso poids **10.8KG**

TEMPERATURA temperature temperatura température **30°-85°**

VOLTAGEM voltage voltaje voltage **220/240V**

FREQUÊNCIA frequency frecuencia fréquence **50/60HZ**

POTÊNCIA power potencia puissance **0.25KW**

**** MODELO** model modelo modèle **SW-395**

PESO weight peso poids **14.5KG**

TEMPERATURA temperature temperatura température **30°-85°**

VOLTAGEM voltage voltaje voltage **220/240V**

FREQUÊNCIA frequency frecuencia fréquence **50/60HZ**

POTÊNCIA power potencia puissance **0.25KW**



recipiente para a água para manter a humidade e o sabor dos alimentos | abertura dupla

container for water to maintain moisture and flavor of foods | double aperture

contenedor para el agua para mantener la humedad y el sabor de los alimentos | abertura doble

réipient pour l'eau pour maintenir l'humidité et le saveur des aliments | ouverture double



VITRINE REFRIGERADORA

refrigerated counter vitrina refrigeradora vitrine réfrigérée

| REF | (cm) | | |
|------------|------------|-----|--------|
| 0432610097 | 90x75x120 | * | 01/001 |
| 0432610127 | 120x75x120 | ** | 01/001 |
| 0432610157 | 150x75x120 | *** | 01/001 |

*** MODELO** model modelo modèle **WDF097F**

TEMPERATURA temperature temperatura température **0°-8°C°**

VOLTAGEM voltage voltaje voltage **220V**

POTÊNCIA power potencia puissance **615W**

**** MODELO** model modelo modèle **WDF127F**

TEMPERATURA temperature temperatura température **0°-8°C°**

VOLTAGEM voltage voltaje voltage **220/240V**

POTÊNCIA power potencia puissance **700W**

***** MODELO** model modelo modèle **WDF157F**

TEMPERATURA temperature temperatura température **0°-8°C°**

VOLTAGEM voltage voltaje voltage **220V**

POTÊNCIA power potencia puissance **800W**





VITRINE REFRIGERADORA

refrigerated counter vitrina refrigeradora vitrine réfrigérée

| REF | (cm) | |
|------------|----------|--------|
| 0432610120 | 70x56x57 | 01/001 |

MODELO model modelo modèle **WTF120L**

PESO weight peso poids **65KG**

TEMPERATURA temperature temperatura température **2°-8°**

VOLTAGEM voltage voltaje voltage **230V**

FREQUÊNCIA frequency frecuencia fréquence **50HZ**



KIT REFRIGERADO BANCADA 5xGN 1/4

refrigerated counter

encimera refrigeradora

comptoirs réfrigérée

| REF | (cm) | |
|------------|---------------|--------|
| 1332613880 | 120x33.5x43.5 | 01/001 |

MODELO model modelo modèle **ESL3880**

CAPACIDADE capacity capacidad capacité **5xGN 1/4**

TEMPERATURA temperature temperatura température **2°-8°C**

VOLTAGEM voltage voltaje voltage **220V**

FREQUÊNCIA frequency frecuencia fréquence **50HZ**

POTÊNCIA power potencia puissance **170W**



KIT REFRIGERADO BANCADA 6xGN 1/4

refrigerated counter

encimera refrigeradora

comptoirs réfrigérée

| REF | (cm) | |
|------------|---------------|--------|
| 1332613861 | 140x33.5x43.5 | 01/001 |

MODELO model modelo modèle **ESL3861**

CAPACIDADE capacity capacidad capacité **6xGN 1/4**

TEMPERATURA temperature temperatura température **2°-8°C**

VOLTAGEM voltage voltaje voltage **220V**

FREQUÊNCIA frequency frecuencia fréquence **50HZ**

POTÊNCIA power potencia puissance **170W**



KIT REFRIGERADO BANCADA 7xGN 1/4

refrigerated counter

encimera refrigeradora

comptoirs réfrigérée

| REF | (cm) | |
|------------|---------------|--------|
| 1332613883 | 150x33.5x43.5 | 01/001 |

MODELO model modelo modèle **ESL3883**

CAPACIDADE capacity capacidad capacité **7xGN 1/4**

TEMPERATURA temperature temperatura température **2°-8°C**

VOLTAGEM voltage voltaje voltage **220V**

FREQUÊNCIA frequency frecuencia fréquence **50HZ**

POTÊNCIA power potencia puissance **170W**



BANCADA REFRIGERADORA SNACK

refrigerated counter
encimera refrigeradora
comptoirs réfrigérée

| REF | (cm) | |
|------------|-----------|--------|
| 1332613421 | 136x60x85 | 01/001 |

MODELO model modelo modèle **EPF3421**

PESO weight peso poids **105KG**

CAPACIDADE capacity capacidad capacité **240LT**

TEMPERATURA temperature temperatura température **-2°~8°C**

VOLTAGEM voltage voltaje voltage **220V**

FREQUÊNCIA frequency frecuencia fréquence **50HZ**

POTÊNCIA power potencia puissance **250W**



BANCADA REFRIGERADORA SNACK

refrigerated counter
encimera refrigeradora
comptoirs réfrigérée

| REF | (cm) | |
|------------|-------------|--------|
| 1332613431 | 179.5x60x85 | 01/001 |

MODELO model modelo modèle **EPF3431**

PESO weight peso poids **125KG**

CAPACIDADE capacity capacidad capacité **420LT**

TEMPERATURA temperature temperatura température **-2°~8°C**

VOLTAGEM voltage voltaje voltage **220V**

FREQUÊNCIA frequency frecuencia fréquence **50HZ**

POTÊNCIA power potencia puissance **300W**



BANCADA REFRIGERADORA SNACK

refrigerated counter
encimera refrigeradora
comptoirs réfrigérée

| REF | (cm) | |
|------------|-----------|--------|
| 1332613441 | 223x60x85 | 01/001 |

MODELO model modelo modèle **EPF3441**

PESO weight peso poids **140KG**

CAPACIDADE capacity capacidad capacité **480LT**

TEMPERATURA temperature temperatura température **-2°~8°C**

VOLTAGEM voltage voltaje voltage **220V**

FREQUÊNCIA frequency frecuencia fréquence **50HZ**

POTÊNCIA power potencia puissance **350W**



BANCADA REFRIGERADORA GN 1/1

refrigerated counter
encimera refrigeradora
comptoirs réfrigérée

| REF | (cm) | |
|------------|---------------|--------|
| 1332613432 | 150x33.5x43.5 | 01/001 |

MODELO model modelo modèle **EPF3432**

PESO weight peso poids **170KG**

CAPACIDADE capacity capacidad capacité **415LT**

TEMPERATURA temperature temperatura température **-2°~8°C**

VOLTAGEM voltage voltaje voltage **220V**

FREQUÊNCIA frequency frecuencia fréquence **50HZ**

POTÊNCIA power potencia puissance **350W**





CONSERVAÇÃO e EXPOSIÇÃO

conservation and exhibition conservación y exposición conservation et exposition



BANCADA REFRIGERADORA

refrigerated counter
encimera refrigeradora
comptoirs réfrigérée

| REF | (cm) | |
|------------|--------------|--------|
| 1332613864 | 136.5x70x110 | 01/001 |

MODELO model modelo modèle **ESL3864**

CAPACIDADE capacity capacidad capacité **7xGN 1/3**

TEMPERATURA temperature temperatura température **2°-8°C**

VOLTAGEM voltage voltaje voltage **220/240V**

FREQUÊNCIA frequency frecuencia fréquence **50HZ**

POTÊNCIA power potencia puissance **300W**



BANCADA REFRIGERADORA

refrigerated counter
encimera refrigeradora
comptoirs réfrigérée

| REF | (cm) | |
|------------|--------------|--------|
| 1332613852 | 136.5x70x110 | 01/001 |

MODELO model modelo modèle **ESL3852**

TEMPERATURA temperature temperatura température **2°-8°C**

VOLTAGEM voltage voltaje voltage **220/240V**

FREQUÊNCIA frequency frecuencia fréquence **50HZ**

POTÊNCIA power potencia puissance **300W**



BANCADA REFRIGERADORA

refrigerated counter
encimera refrigeradora
comptoirs réfrigérée

| REF | (cm) | |
|------------|------------|--------|
| 1332613490 | 151x80x100 | 01/001 |

MODELO model modelo modèle **EFP3490**

TEMPERATURA temperature temperatura température **-2°-8°C**

VOLTAGEM voltage voltaje voltage **220V**

FREQUÊNCIA frequency frecuencia fréquence **50HZ**

POTÊNCIA power potencia puissance **330W**



1



2



ESTUFA P/ALIMENTOS

stove for food
estufa para comida
armoire chauffante cuisine

| REF | (cm) | |
|-------------|-----------|-----------|
| 13323800051 | 54x68x94 | * 01/004 |
| 1332380011 | 54x68x138 | ** 01/002 |

* MODELO model modelo modèle **FW-5**

CAPACIDADE capacity capacidad capacité **10xGN 1/1**

POTÊNCIA power potencia puissance **2620W**



** MODELO model modelo modèle **FW-11**

CAPACIDADE capacity capacidad capacité **22xGN 1/1**

POTÊNCIA power potencia puissance **2620W**





ARMÁRIO FRIGORÍFICO GN 2/1
refrigerated cabinet
armario frigorífico
armoire réfrigérée

| REF | (cm) | |
|------------|-------------|--------|
| 1332618116 | 73x84.5x213 | 01/001 |

MODELO model modelo modèle **MBF8116**
TEMPERATURA temperature temperatura température **-2°-8°C**
VOLTAGEM voltage voltaje voltage **220V**
FREQUÊNCIA frequency frecuencia fréquence **50HZ**
POTÊNCIA power potencia puissance **330W**



ARMÁRIO CONGELADOR GN 2/1 - 2 PORTAS
freezing cabinet
armario congelador
armoire congélateur

| REF | (cm) | |
|------------|-------------|--------|
| 1332618119 | 73x84.5x213 | 01/001 |

MODELO model modelo modèle **MBF8119**
TEMPERATURA temperature temperatura température **-22°-17°C**
VOLTAGEM voltage voltaje voltage **220V**
FREQUÊNCIA frequency frecuencia fréquence **50HZ**
POTÊNCIA power potencia puissance **600W**



ARMÁRIO FRIGORÍFICO GN 2/1 - 2 PORTAS
refrigerated cabinet
armario frigorífico
armoire réfrigérée

| REF | (cm) | |
|------------|-------------|--------|
| 1332618122 | 73x84.5x210 | 01/001 |

MODELO model modelo modèle **MBF8122**
TEMPERATURA temperature temperatura température **-2°-8°C**
VOLTAGEM voltage voltaje voltage **220V**
FREQUÊNCIA frequency frecuencia fréquence **50HZ**
POTÊNCIA power potencia puissance **338W**



30uni.

AQUECEDOR PRATOS
hot cupboards calentador de platos chauffe-assiettes

| REF | (cm) | |
|------------|------------|--------|
| 1332389003 | 45x42.5x52 | 01/010 |

MODELO model modelo modèle **EPW-MINI**
CAPACIDADE capacity capacidad capacité **30UNI.**
VOLTAGEM voltage voltaje voltage **220/240V**
FREQUÊNCIA frequency frecuencia fréquence **50/60HZ**
POTÊNCIA power potencia puissance **0.4KW**



60uni.

AQUECEDOR PRATOS
hot cupboards calentador de platos chauffe-assiettes

| REF | (cm) | |
|------------|------------|--------|
| 1332389001 | 45x42.5x82 | 01/010 |

MODELO model modelo modèle **EPW-1**
CAPACIDADE capacity capacidad capacité **60UNI.**
VOLTAGEM voltage voltaje voltage **220/240V**
FREQUÊNCIA frequency frecuencia fréquence **50/60HZ**
POTÊNCIA power potencia puissance **0.75KW**



120uni.

AQUECEDOR PRATOS
hot cupboards calentador de platos chauffe-assiettes

| REF | (cm) | |
|------------|------------|--------|
| 1332389002 | 75x42.5x82 | 01/010 |

MODELO model modelo modèle **EPW-2**
CAPACIDADE capacity capacidad capacité **120UNI.**
VOLTAGEM voltage voltaje voltage **220/240V**
FREQUÊNCIA frequency frecuencia fréquence **50/60HZ**
POTÊNCIA power potencia puissance **1.2KW**



NOVO
new

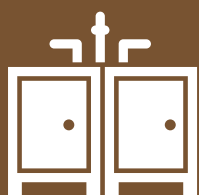

EQUIPAMENTOS PARA COZINHA

kitchen equipment
equipos para cocina
equipement de cuisine



EQUIPAMENTOS para cozinha

kitchen equipment equipos para cocina *équipement de cuisine*

Cada vez mais o espaço, organização e limpeza são factores muito importantes em qualquer serviço de alimentação especialmente numa cozinha. Foi a pensar nestas características, que pensamos em apostar em equipamentos para hotelaria, catering, restaurantes, bares, pastelarias e cozinhas profissionais.

Estes equipamentos permitem:

- organização do espaço
- criar áreas práticas para a preparação de comida e armazenagem dos alimentos
- facilidade na limpeza
- durabilidade

Increasingly space, organization and cleaning are very important factors in any food service especially in a kitchen.

It was to think of these characteristics, that we thought of betting on equipment for hotels, catering, restaurants, bars, pastry shops and professional kitchens.

These equipments allow:

- organization of space
- create practical areas for food preparation and food storage
- easy cleaning
- durability

Cada vez más el espacio, la organización y la limpieza son factores muy importantes en cualquier servicio de alimentación especialmente en una cocina.

Fue a pensar en estas características, que pensamos en apostar en equipamientos para hostelería, catering, restaurantes, bares, pastelerías y cocinas profesionales.

Estos equipos permiten:

- organización del espacio
- crear áreas prácticas para la preparación de alimentos y el almacenamiento de los alimentos
- facilidad en la limpieza
- durabilidad

De plus en plus d'espace, d'organisation et de nettoyage sont des facteurs très importants dans tout service de restauration, en particulier dans une cuisine.

C'est à penser à ces caractéristiques, que nous avons pensé à parier sur des équipements pour hôtels, traiteurs, restaurants, bars, pâtisseries et cuisines professionnelles.

Ces équipements permettent:

- organisation de l'espace
- créer des espaces pratiques pour la préparation et le stockage des aliments
- nettoyage facile
- la durabilité



BANCADA 2 NÍVEIS

working table mesa de trabajo table de travail

| REF | (cm) |  |
|------------|-----------|---|
| 1334130001 | 100x60x85 | 01/001 |
| 1334130002 | 120x60x85 | 01/001 |
| 1334130003 | 180x60x85 | 01/001 |



BANCADA C/ABA

working table mesa de trabajo table de travail

| REF | (cm) |  |
|------------|--------------|---|
| 1334130004 | 100x60x85+10 | 01/001 |
| 1334130005 | 120x60x85+10 | 01/001 |
| 1334130006 | 180x60x85+10 | 01/001 |





EQUIPAMENTO PARA COZINHA

kitchen equipment equipos para cocina équipement de cuisine



INOX **NOVO**
new

BANCADA

working table mesa de trabajo table de travail

| REF | (cm) | |
|------------|----------|--------|
| 1334130007 | 80x60x85 | 01/001 |
| 1334130008 | 80x70x85 | 01/001 |



INOX **NOVO**
new

ALÇADO C/2 NÍVEIS P/BANCADA

table shelves estantes para mesa étagères de table

| REF | (cm) | |
|------------|-----------|----------|
| 1334130009 | 100x30x60 | * 01/001 |



INOX **NOVO**
new

ALÇADO C/3 NÍVEIS P/BANCADA

table shelves estantes para mesa étagères de table

| REF | (cm) | |
|------------|-----------|-----------|
| 1334130010 | 120x30x90 | ** 01/001 |



INOX **NOVO**
new

PRATELEIRAS DUPLA P/PAREDE

wall shelves estantes para pared étagères murales

| REF | (cm) | |
|------------|-----------|--------|
| 1334130011 | 100x30x60 | 01/001 |

INOX **NOVO**
new

BANCADA C/2 PORTAS CORRER

cabinet with sliding doors
armario con puertas correderas
armoie à portes coulissantes

| REF | (cm) |  |
|------------|-----------|---|
| 1334130012 | 150x60x85 | 01/001 |
| 1334130013 | 200x60x85 | 01/001 |



INOX **NOVO**
new

BANCADA C/2 PORTAS CORRER C/ABA

cabinet with sliding doors
armario con puertas correderas
armoie à portes coulissantes

| REF | (cm) |  |
|------------|--------------|---|
| 1334130014 | 150x60x85+10 | 01/001 |
| 1334130015 | 200x60x85+10 | 01/001 |



INOX **NOVO**
new

BANCADA C/2 PORTAS CORRER

C/ 3 GAVETAS C/ABA
cabinet with sliding doors and drawers
armario con puertas correderas con calzoncillos
armoie à portes coulissantes avec tiroirs

| REF | (cm) |  |
|------------|--------------|---|
| 1334130016 | 200x60x85+10 | 01/001 |



INOX **NOVO**
new

PIA C/ABA

single sink lava platos lavar la vaisselle

| REF | (cm) |  |
|------------|-------------|---|
| 1334130017 | 60x60x85+10 | 01/001 |

CUBA 40x40x30cm





PIA DUPLA C/ABA
double sink lavabo doble lavar la vaisselle double

| REF | (cm) | |
|------------|--------------|--------|
| 1334130018 | 120x60x85+10 | 01/001 |

CUBAS 40x40x30cm



BANHO MARIA 4xGN1/1
bain marie baño maria bain-marie

| REF | (cm) | |
|------------|-----------|--------|
| 1334130019 | 150x70x85 | 01/001 |



BANHO MARIA 5xGN1/1
bain marie baño maria bain-marie

| REF | (cm) | |
|------------|-----------|--------|
| 1334130020 | 180x70x85 | 01/001 |



BANHO MARIA P/SELF SERVICE 4xGN1/1
bain marie baño maria bain-marie

| REF | (cm) | |
|------------|-----------|--------|
| 1334130021 | 150x70x85 | 01/001 |



PROTECÇÃO

protection
protección
protection



ELECTROCUTORES PAREDE
wall mounted mosquito killer
mata mosquitos de pared
appareil anti-moustiques muraux

| | (cm) | |
|------------|----------|--------|
| 1331440018 | 40x20x24 | 01/006 |

MODELO model modelo modèle **V18E**
LÂMPADAS lamps lámparas lampes **1 UNI.**
FREQUÊNCIA frequency frecuencia fréquence **50HZ**
POTÊNCIA power potencia puissance **230W**



LÂMPADA
lamp lámpara lampe

| REF | (cm) | |
|-------------|-------|--------|
| 13314400182 | - 13W | 01/001 |



PACK
4

RECARGA PAPEL AUTOCOLANTE
glueboard replacement
papel autoadhesivo
papier autocolant

| REF | (cm) | |
|-------------|--------------|--------|
| 13314400181 | 38.5-22.5x15 | 01/006 |



ELECTROCUTORES TECTO
ceiling suspend mosquito killer
mata mosquitos de techo
appareil anti-moustiques pour plafond

| REF | (cm) | | |
|------------|----------------|-----|--------|
| 1230278122 | 37x11.5x32.5 | * | 01/006 |
| 1230278320 | 64.5x11.5x39.5 | ** | 01/004 |
| 1230278220 | 64.5x11.5x41 | *** | 01/004 |

*** MODELO** model modelo modèle **JX888-1X22W**
LÂMPADAS lamps lámparas lampes **1 UNI.**
VOLTAGEM voltage voltaje voltage **1800-3000V**
POTÊNCIA power potencia puissance **1x22W**

**** MODELO** model modelo modèle **JX888-3X20W**
LÂMPADAS lamps lámparas lampes **3 UNI.**
VOLTAGEM voltage voltaje voltage **1800-3000V**
POTÊNCIA power potencia puissance **3x20W**

***** MODELO** model modelo modèle **JX888-2X20W**
LÂMPADAS lamps lámparas lampes **2 UNI.**
VOLTAGEM voltage voltaje voltage **1800-3000V**
POTÊNCIA power potencia puissance **3x20W**

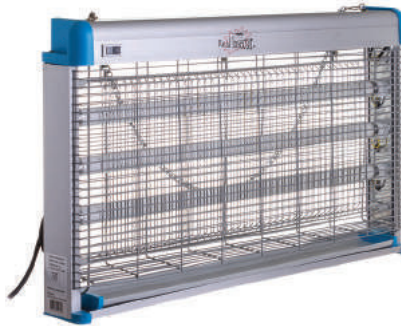

ELECTROCUTORES PAREDE
wall mounted mosquito killer
mata mosquitos de pared
appareil anti-moustiques muraux

| REF | (cm) | | |
|------------|-------------|----|--------|
| 1230270220 | 64.5x8x39.5 | * | 01/006 |
| 1230270320 | 64.5x8x39.5 | ** | 01/004 |

*** MODELO** model modelo modèle **JB20-2X20W**
LÂMPADAS lamps lámparas lampes **2 UNI.**
VOLTAGEM voltage voltaje voltage **1800-3000V**
POTÊNCIA power potencia puissance **2x20W**

**** MODELO** model modelo modèle **JB20-3X20W**
LÂMPADAS lamps lámparas lampes **3 UNI.**
VOLTAGEM voltage voltaje voltage **1800-3000V**
POTÊNCIA power potencia puissance **3x20W**



cadeira alta de bebé para restaurante
fabricada em polipropileno com arnês de segurança e uma barra em forma de T.
fácil de limpar e armazenar (empilhável)

baby high chair for restaurant
made of polypropylene with safety harness and a T-bar.
easy to clean and store (stackable)

silla alta de bebé para el restaurante
hecha de polipropileno con arnés de seguridad y una forma de barra en T
fácil de limpiar y almacenar (apilable)

chaise haute bébé pour le restaurant
en polypropylène avec harnais de sécurité et une forme de T-bar
facile à nettoyer et à ranger (empilable)

**a segurança das crianças
na hora da alimentação**

the safety of children at the time of feeding
seguridad para niños en el momento de la alimentación
la sécurité des enfants au moment de l'alimentation



CADEIRA BEBÉ
baby seat asiento infantil siège de bébé

| REF | (cm) | |
|------------|----------|--------|
| 0730372601 | 55x61x74 | 01/001 |

Soluções para o exterior

exterior solutions soluciones exteriores solutions à l'extérieur



As nossas soluções de luz e aquecimento exteriores, permitem transformar os seus espaços exteriores de convívio e de lazer em espaços confortáveis por diversas horas.

Our outdoor light and heating solutions allow you to transform your outdoor living and leisure spaces into comfortable spaces for several hours.

Nuestras soluciones de luz y calefacción al aire libre, le permiten transformar sus espacios de vida al aire libre y el ocio en espacios cómodos durante varias horas.

Nos solutions d'éclairage et de chauffage en plein air, vous permettent de transformer vos espaces de vie en plein air et de loisirs dans des espaces confortables pendant plusieurs heures.



CANDEEIRO D/JARDIM

garden lamp lâmpara de jardim lampe de jardin

| REF | (cm) |  |
|------------|---------|---|
| 1300410017 | Ø17x100 | 01/001 |

CANDEEIRO D/JARDIM

garden lamp lâmpara de jardim lampe de jardin

| REF | (cm) |  |
|------------|--------|--|
| 1300410026 | Ø23x62 | 01/001 |

CANDEEIRO D/JARDIM

garden lamp lâmpara de jardim lampe de jardin

| REF | (cm) |  |
|-------------|----------|---|
| 13004100271 | Ø30x64.5 | 01/001 |



AQUECEDOR JARDIM

outdoor gas heater
calentador de terraza
lampe chauffante extérieure

| REF | (cm) |  |
|------------|------|---|
| 1337490002 | 220 | 01/001 |

MODELO model modelo modèle PV-02

PESO weight peso poids 27KG

CONSUMO DE GÁS gas consumption consumo de gas consommation de gaz 0.9KG/H

CATEGORIA category categoria catégorie 50HZ

POTÊNCIA power potência puissance 1KW

aquecedor externo e interno para áreas amplas e ventiladas (jardins, piscinas, esplanadas, etc)
seguro, prático e económico

external and internal heater for large and ventilated areas (gardens, swimming pools, terraces, etc.)
safe, practical and economical

calentador externo e interno a las áreas grandes y ventilados (jardines, piscinas, terrazas, etc.)
seguro, práctico y económico

lampe chauffante extérieure et intérieure pour les espaces amples et ventilés (jardins, piscines, terrasses, etc.) sûre, pratique et économique





fardas/calçado
uniforms/footwear
uniformes/calzado
uniformes/chaussures



FARDAS/CALÇADO

uniformes/footwear uniformes/calzado uniformes/chaussures



JALECA COZINHEIRO
chef jacket chaquetas de jefe vestes de cuisine

| REF | N° | <input type="checkbox"/> | |
|------------|----|-------------------------------------|--------|
| 1433920111 | S | <input type="checkbox"/> | 01/025 |
| 1433920112 | M | <input type="checkbox"/> | 01/025 |
| 1433920113 | L | <input type="checkbox"/> | 01/025 |
| 1433920114 | XL | <input type="checkbox"/> | 01/025 |
| 1433920121 | S | <input checked="" type="checkbox"/> | 01/025 |
| 1433920122 | M | <input checked="" type="checkbox"/> | 01/025 |
| 1433920123 | L | <input checked="" type="checkbox"/> | 01/025 |
| 1433920124 | XL | <input checked="" type="checkbox"/> | 01/025 |



JALECA COZINHEIRO
chef jacket chaquetas de jefe vestes de cuisine

| REF | N° | <input type="checkbox"/> | |
|------------|----|-------------------------------------|--------|
| 1433920211 | S | <input type="checkbox"/> | 01/025 |
| 1433920212 | M | <input type="checkbox"/> | 01/025 |
| 1433920213 | L | <input type="checkbox"/> | 01/025 |
| 1433920214 | XL | <input type="checkbox"/> | 01/025 |
| 1433920221 | S | <input checked="" type="checkbox"/> | 01/025 |
| 1433920222 | M | <input checked="" type="checkbox"/> | 01/025 |
| 1433920223 | L | <input checked="" type="checkbox"/> | 01/025 |
| 1433920224 | XL | <input checked="" type="checkbox"/> | 01/025 |



JALECA COZINHEIRO
chef jacket chaquetas de jefe vestes de cuisine

| REF | N° | <input type="checkbox"/> | |
|------------|----|-------------------------------------|--------|
| 1433920311 | S | <input type="checkbox"/> | 01/025 |
| 1433920312 | M | <input type="checkbox"/> | 01/025 |
| 1433920313 | L | <input type="checkbox"/> | 01/025 |
| 1433920314 | XL | <input type="checkbox"/> | 01/025 |
| 1433920321 | S | <input checked="" type="checkbox"/> | 01/025 |
| 1433920322 | M | <input checked="" type="checkbox"/> | 01/025 |
| 1433920323 | L | <input checked="" type="checkbox"/> | 01/025 |
| 1433920324 | XL | <input checked="" type="checkbox"/> | 01/025 |



CALÇAS COZINHEIRO
chef pants pantalones de jefe pantalon de cuisine

| REF | N° | | |
|------------|----|--|--------|
| 1433920401 | S | | 01/025 |
| 1433920402 | M | | 01/025 |
| 1433920403 | L | | 01/025 |
| 1433920404 | XL | | 01/025 |



CALÇAS COZINHEIRO
chef pants pantalones de jefe pantalon de cuisine

| REF | N° | | |
|------------|----|--|--------|
| 1433920511 | S | | 01/025 |
| 1433920512 | M | | 01/025 |
| 1433920513 | L | | 01/025 |
| 1433920514 | XL | | 01/025 |



CALÇAS COZINHEIRO
chef pants pantalones de jefe pantalon de cuisine

| REF | N° | | |
|------------|----|--|--------|
| 1433920521 | S | | 01/025 |
| 1433920522 | M | | 01/025 |
| 1433920523 | L | | 01/025 |
| 1433920524 | XL | | 01/025 |



AVENTAL
apron delantal tablier

| REF | (cm) | | |
|------------|--------|--|--------|
| 1433920610 | 70x100 | | 01/050 |
| 1433920620 | 70x100 | | 01/050 |
| 1433920630 | 70x100 | | 01/050 |
| 1433920640 | 70x100 | | 01/050 |



AVENTAL
apron delantal tablier

| REF | (cm) | | |
|------------|-------|--|--------|
| 1433920720 | 90x45 | | 01/050 |
| 1433920740 | 90x45 | | 01/050 |



LENÇO
kerchief bufanda coiffe de cuisine

| REF | N° | | |
|------------|----|--|--------|
| 1433920810 | ** | | 01/100 |
| 1433920820 | ** | | 01/100 |

** tamanho único unique size
tamaño unico taille unique



BIVAQUE PASTELEIRO
confectioner's hat bivaque de confetteria toque de boulanger

| REF | N° | | |
|------------|----|--|--------|
| 1433920910 | ** | | 01/100 |

** tamanho único unique size
tamaño unico taille unique



Calçado de protecção

security shoes calzado protector chaussures de protection

A melhor gama de calçado de protecção para ambientes de trabalho

The best available range of security shoes for the working place

La mejor gama de calzado protector para al ambiente de trabajo

La meilleure gamme de chaussures de sécurité pour la restauration



sola anti choque
antichoc sole
absorción de energia



resistência a água
water repellent
resistencia a la agua
hydrofuge



resistente
a hidrocarbonetos
hydrocarbon repellent
resistente a los hidrocarburos
resistance aux hydrocarbures



resistance a 200j
resistent to 200j
resistencia hasta 200j
embout 200j



anti estático
antistatic
antiestático
antistaque



SAPATO BACHELITE
shoes calzado chaussures

| REF | N° | |
|------------|----|--------|
| 1439831501 | 38 | 01/001 |
| 1439831502 | 39 | 01/001 |
| 1439831503 | 40 | 01/001 |
| 1439831504 | 41 | 01/001 |
| 1439831505 | 42 | 01/001 |
| 1439831506 | 43 | 01/001 |
| 1439831507 | 44 | 01/001 |
| 1439831508 | 45 | 01/001 |
| 1439831509 | 46 | 01/001 |

EN ISO 20345:2011 S2 SRC
microfibra
palmilha: GIOVE
ponta: metal
forro: sem tecido
números: 38/48

EN ISO 20345:2011 S2 SRC
microfibra
insole: GIOVE
toe-cap: metal
lining: no fabric
numbers: 38 / 48

EN ISO 20345:2011 S2 SRC
microfibra
suela: GIOVE
punta: metal
forro: no tejido
numeros: 38/48

EN ISO 20345:2011 S2 SRC
microfibra
semelle de propretre:GIOVE
embout: metal
doublure: non tissé
pointure:38/48

SOLA ODEON sole suela semelle

Sola - Borracha resistente a temperaturas extremas de -20°C a + 300°C. Grande capacidade anti-derrapante. Excelente flexibilidade e grande flexibilidade resistência a la abrasión.
Excelente antiderrapante. Excelente resistência a hidrólise. Resistência a baixas temperaturas até -20°C. Máxima flexibilidade e resistência a abrasão.

Sole - Rubber resistant to extreme temperatures of between -20°C and +300°C. High slip resistance. Excellent softness and great flexibility. Very high abrasion resistance.
Excellent grip. High resistance to hydrolysis. Resistance to low temperatures up to -20°. Maximum flexibility and abrasion resistance.

Suela - Gomma resistente a temperaturas extremas de -20°C a + 300°C. Gran capacidad antideslizante. Excelente flexibilidad y gran flexibilidad muy fuerte resistencia a la abrasión.
Excelente antideslizante. Excelente resistencia a la hidrólisis. Resistencia a bajas temperaturas hasta -20°C. Máxima flexibilidad y resistencia a la abrasión.

Semelle - Caoutchouc résistante aux températures extrêmes de -20°C à +300°C. Grande capacité antidérapante. Excellente souplesse et grande flexibilité très forte résistance à l'abrasion.
Excellent antidérapant. Excellente résistance à l'hydrolyse. Résistance aux basses températures jusqu'à -20°C. Maximum de flexibilité et de résistance à l'abrasion.





SAPATO PLUTONE

shoes calzado chaussures

| REF | Nº | |
|------------|----|--------|
| 1439838501 | 38 | 01/001 |
| 1439838502 | 39 | 01/001 |
| 1439838503 | 40 | 01/001 |
| 1439838504 | 41 | 01/001 |
| 1439838505 | 42 | 01/001 |
| 1439838506 | 43 | 01/001 |
| 1439838507 | 44 | 01/001 |



EN ISO 20345:2011 S2 SRC
microfibra
palmilha: GIOVE
ponta: metal
forro: sem tecido
números: 38/48

EN ISO 20345:2011 S2 SRC
microfibra
insole: GIOVE
toe-cap: metal
lining: no fabric
numbers: 38/48

EN ISO 20345:2011 S2 SRC
microfibra
suela: GIOVE
punta: metal
forro: no tejido
numeros: 38/48

EN ISO 20345:2011 S2 SRC
microfibra
semelle de proprete: GIOVE
embout: metal
doublure: non tissé
pointure: 38/48

SOLA ODEON

sole suela semelle

Sola - Borracha resistente a temperaturas extremas de -20°C a +300°C. Grande capacidade anti-derrapante. Excelente flexibilidade e grande flexibilidade resistência muito forte à abrasão. Excelente antiderrapante. Excelente resistência à hidrólise. Resistência a baixas temperaturas até -20°C. Máxima flexibilidade e resistência à abrasão.

Sole - Rubber resistant to extreme temperatures of between -20°C and +300°C. High slip resistance. Excellent softness and great flexibility. Very high abrasion resistance. Excellent grip. High resistance to hydrolysis. Resistance to low temperatures up to -20°C. Maximum flexibility and abrasion resistance.

Suela - Gomma resistente a temperaturas extremas de -20°C a +300°C. Gran capacidad antideslizante. Excelente flexibilidad y gran flexibilidad muy fuerte resistencia a la abrasión. Excelente antideslizante. Excelente resistencia a la hidrólisis. Resistencia a bajas temperaturas hasta -20°C. Máxima flexibilidad y resistencia a la abrasión.

Semelle - Caoutchouc résistante aux températures extrêmes de -20°C à +300°C. Grande capacité antidérapante. Excellente souplesse et grande flexibilité très forte résistance à l'abrasion. Excellent antidérapant. Excellente résistance à l'hydrolyse. Résistance aux basses températures jusqu'à -20°C. Maximum de flexibilité et de résistance à l'abrasion.



SAPATO EBANITE

shoes calzado chaussures

| REF | Nº | |
|------------|----|--------|
| 1439831401 | 35 | 01/001 |
| 1439831402 | 36 | 01/001 |
| 1439831403 | 37 | 01/001 |
| 1439831404 | 38 | 01/001 |
| 1439831405 | 39 | 01/001 |
| 1439831406 | 40 | 01/001 |
| 1439831407 | 41 | 01/001 |



EN ISO 20345:2011 S2
SRA
microfibra
palmilha: GIOVE
ponta: metal
forro: sem tecido
números: 35/42

EN ISO 20345:2011 S2
SRA
microfibra
suela: GIOVE
punta: metal
forro: no tejido
numeros: 35/42

EN ISO 20345:2011 S2 SRA
microfibra
insole: GIOVE
toe-cap: metal
lining: no fabric
numbers: 35/42

EN ISO 20345:2011 S2 SRA
microfibra
semelle de proprete: GIOVE
embout: metal
doublure: non tissé
pointure: 35/42

SOLA LADY ITALY

sole suela semelle

Sola - densidade simples com PU antiderrapante

Sole - single density in PU slip resistance
Suela - densidad simple con PU antideslizante
Semelle - mono densité en PU antidérapante



SAPATO STELLA

shoes calzado chaussures

| REF | Nº | |
|------------|----|--------|
| 1439830401 | 35 | 01/001 |
| 1439830402 | 36 | 01/001 |
| 1439830403 | 37 | 01/001 |
| 1439830404 | 38 | 01/001 |
| 1439830405 | 39 | 01/001 |
| 1439830406 | 40 | 01/001 |



EN ISO 20345:2011 S2
SRA
microfibra
palmilha: GIOVE
ponta: metal
forro: sem tecido
números: 35/42

EN ISO 20345:2011 S2
SRA
microfibra
suela: GIOVE
punta: metal
forro: no tejido
numeros: 35/42

EN ISO 20345:2011 S2 SRA
microfibra
insole: GIOVE
toe-cap: metal
lining: no fabric
numbers: 35/42

EN ISO 20345:2011 S2 SRA
microfibra
semelle de proprete: GIOVE
embout: metal
doublure: non tissé
pointure: 35/42

SOLA LADY ITALY

sole suela semelle

Sola - densidade simples com PU antiderrapante

Sole - single density in PU slip resistance
Suela - densidad simple con PU antideslizante
Semelle - mono densité en PU antidérapante





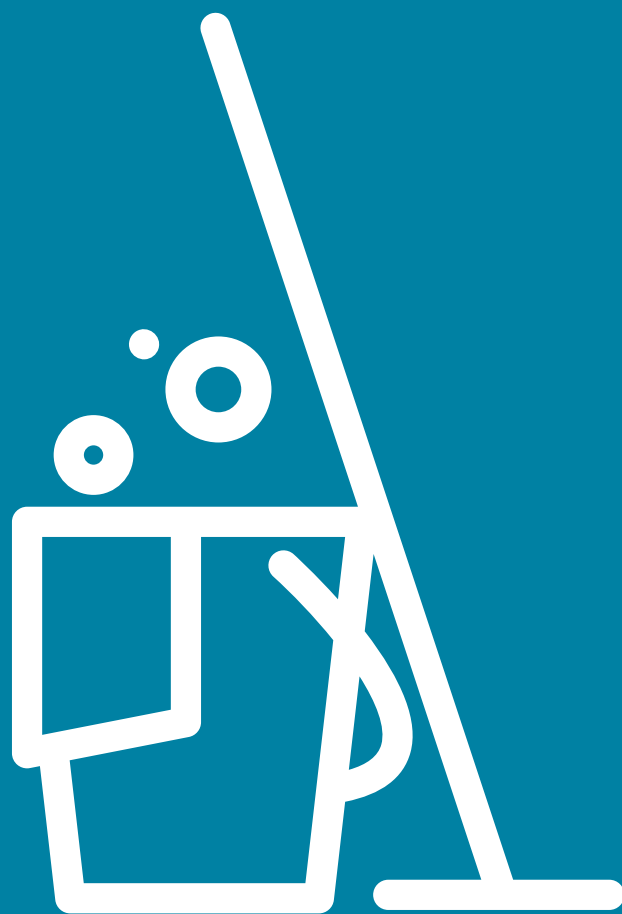

limpeza cleaning
limpieza nettoyage

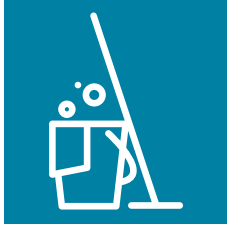

Limpeza

cleaning limpeza nettoyage

331



CARROS LIMPEZA/BALDES

cleaning cart/buckets carros de limpeza/cubos chariot de nettoyage/seaux

337



UTENSÍLIOS & MÁQUINAS

utensils and machines utensilios y maquinaria ustensiles et machines

341



HIGIENE & PROTECÇÃO

hygiene and protection higiene y protección hygiène et protection





CARROS LIMPEZA/BALDES

cleaning cart/buckets
carros de limpeza/ cubos
chariot de nettoyage seaux





CARROS de LIMPEZA/BALDES

cleaning cart/buckets carros de limpeza/cubos chariot de nettoyage/seaux



CARRO LIMPEZA
cleaning cart carro de limpeza chariot de nettoyage

| REF | (cm) | |
|------------|------------|--------|
| 0730378180 | 130x55x100 | 01/001 |



CARRO LIMPEZA MULTIFUNÇÕES
cleaning cart carro de limpeza chariot de nettoyage

| REF | (cm) | LT | |
|------------|--------------|----|--------|
| 0730269997 | 121x57.5x112 | 38 | 01/001 |



CARRO LIMPEZA C/SACO
cleaning cart with bag
carro de limpeza con bolsa
chariot de nettoyage avec sac

| REF | (cm) | |
|----------------------|------------------------|--------|
| 0730370160 1 | 105x55x95 | 01/001 |
| 07303701591 2 | 38x26x69 10KG 60LT | 01/001 |



CARRO LIMPEZA C/2 SACOS
cleaning cart with 2 bags
carro de limpeza con 2 bolsas
chariot de nettoyage avec 2 sacs

| REF | (cm) | |
|----------------------|------------------------|--------|
| 0730370159 1 | 143x54x98.5 | 01/001 |
| 07303701591 2 | 38x26x69 10KG 60LT | 01/001 |



CARRO LONA X
X folding canvas cart
carro de lona X
chariot en toile X

| REF | (cm) | |
|----------------------|-----------------|--------|
| 0730370157 1 | 60x60x100 | 01/001 |
| 07303701571 2 | 55x55x81 38LT | 01/001 |



CARRO LIMPEZA C/PRENSA
cleaning cart with wringer
carro de limpeza con prensa
chariot de nettoyage avec presse

| REF | (cm) | |
|------------|-------------------|--------|
| 0730378090 | 53x34x96.5 42LT | 01/001 |





CARRO LIMPEZA C/2 SACOS
cleaning cart with 2 bags
carro de limpeza con 2 bolsas
chariot de nettoyage avec 2 sacs

| REF | (cm) | |
|-------------|-------------------|--------|
| 0730370071 | 66x34x81 2x25LT | 01/001 |
| 07303700711 | 52x24.4x50 | 01/010 |
| 07303780721 | 35.5x32x32 25LT | 01/010 |
| 0730378072 | 35.5x32x32 25LT | 01/010 |



CARRO LIMPEZA C/PRENSA
cleaning cart with wringer
carro de limpeza con prensa
chariot de nettoyage avec presse

| REF | (cm) | |
|------------|-------------------|--------|
| 0730370070 | 49x40x96.5 23LT | 01/001 |

balde bucket cubo seu 35x32.5x31.5cm



CARRO LIMPEZA C/PRENSA
cleaning cart with wringer
carro de limpeza con prensa
chariot de nettoyage avec presse

| REF | (cm) | |
|-------------|-------------------|--------|
| 0730378083 | 39x32.5x79 25LT | 01/001 |
| 07303780831 | 25x22x56 | 01/010 |

balde bucket cubo seu 31x30.5x28cm



CARRO LIMPEZA C/PRENSA
cleaning cart with wringer
carro de limpeza con prensa
chariot de nettoyage avec presse

| REF | (cm) | |
|------------|-------------------|--------|
| 0730378068 | 43x27x66.5 20LT | 01/001 |



BALDE P/ENCERAR
bucket cubo seu

| REF | (cm) | |
|------------|-----------------|--------|
| 0730370219 | 55x27x35 25LT | 01/001 |



BALDE + CENTRIFUGADORA + ESFREGONA
bucket + centrifuge + mop
cubo + centrifuga + fregona
seau + centrifugeuse + serpillière

| REF | (cm) | LT | |
|------------|------|----|--------|
| 0730378059 | * | 25 | 01/001 |

balde bucket cubo seu 43x29x30.5
centrifugadora centrifuge centrifuga centrifugeuse Ø21x11
cabo esfregona cable mop fregona por cable câble vadrouille Ø16.5x119



PLACA INFORMATIVA
information panel placa de información plaque informative

| REF | (cm) | |
|------------|--------------|--------|
| 0730373042 | 31.5x28.5x64 | 01/001 |

"chão molhado" "wet floor" "suelo mojado" "sol mouillé"



CARROS de LIMPEZA/BALDES

cleaning cart/buckets carros de limpeza/cubos chariot de nettoyage/seaux



PP

BALDE LIXO

waste container cubo de basura poubelle

| REF | (cm) | LT | |
|-------------|-----------|-----|--------|
| 0730370303 | 65x68x105 | 240 | 01/004 |
| 07303703032 | 65x68x105 | 240 | 01/004 |
| 07303703031 | 65x68x105 | 240 | 01/004 |
| 07303703021 | 56x58x90 | 120 | 01/004 |
| 07303703023 | 56x58x90 | 120 | 01/004 |
| 07303703022 | 56x58x90 | 120 | 01/004 |
| 0730370302 | 56x58x90 | 120 | 01/004 |



PP

BALDE LIXO C/PEDAL

waste container cubo de basura poubelle

| REF | (cm) | LT | |
|------------|----------|-----|--------|
| 0732960993 | 60x50x95 | 125 | 01/003 |



PP

BALDE LIXO

waste container cubo de basura poubelle

| REF | (cm) | LT | |
|-------------|------------|----|--------|
| 0732960992 | 51x44x73 | 80 | 01/003 |
| 07329609921 | 50.5x45x73 | 80 | 01/003 |



PP

BALDE LIXO C/PEDAL

waste container cubo de basura poubelle

| REF | (cm) | LT | |
|-------------|------------|----|--------|
| 0730377317 | 49x41x65 | 68 | 01/003 |
| 07303773171 | 49x41x65 | 68 | 01/003 |
| 0730377331 | 41x39.8x60 | 45 | 01/003 |
| 07303773311 | 41x39.8x60 | 45 | 01/003 |



PP

BALDE LIXO C/PEDAL

waste container cubo de basura poubelle

| REF | (cm) | LT | |
|------------|------------|----|--------|
| 0730377040 | 32x29x42.5 | 18 | 01/004 |



PP

BALDE LIXO

waste container cubo de basura poubelle

| REF | (cm) | LT | |
|------------|----------|----|--------|
| 0730377312 | 41x41x70 | 60 | 01/005 |



PP

BALDE LIXO

waste container cubo de basura poubelle

| REF | (cm) | LT | |
|------------|----------|----|--------|
| 0730377006 | 36x27x64 | 35 | 01/001 |



BALDE LIXO
waste container cubo de basura poubelle

| REF | (cm) | LT | |
|------------|--------|----|--------|
| 0731030935 | Ø47x60 | 60 | 01/001 |



BALDE LIXO C/PEDAL
waste container cubo de basura poubelle

| REF | (cm) | LT | |
|------------|----------|----|--------|
| 0732960640 | 25x32x29 | 10 | 01/006 |



BALDE LIXO C/PEDAL
waste container cubo de basura poubelle

| REF | (cm) | LT | |
|------------|----------|----|--------|
| 0732960645 | 27x38x41 | 17 | 01/006 |



BALDE LIXO C/PEDAL
waste container cubo de basura poubelle

| REF | (cm) | LT | |
|------------|----------|------|--------|
| 0732961185 | Ø27x52.5 | 21.4 | 01/006 |
| 0732960186 | Ø23x26 | 6 | 01/006 |
| 0732960181 | Ø18x21 | 3 | 01/012 |



BALDE LIXO
waste container cubo de basura poubelle

| REF | (cm) | LT | |
|------------|--------------|----|--------|
| 0732960194 | 36.5x26.5x60 | 36 | 01/016 |
| 0732960191 | 27x22x44.5 | 14 | 01/024 |

fecho metálico metal clasp cierre metálico fermoir en métal



BALDE LIXO C/PEDAL
pedal bin papelera con pedal poubelle à pédale

| REF | (cm) | LT | |
|------------|--------|----|--------|
| 0431629648 | Ø30x70 | 33 | 01/001 |



BALDE LIXO C/PEDAL
pedal bin papelera con pedal poubelle à pédale

| REF | (cm) | LT | |
|------------|----------|----|--------|
| 0431629248 | 50x25x68 | 40 | 01/001 |



BALDE LIXO C/PEDAL
pedal bin papelera con pedal poubelle à pédale

| REF | (cm) | LT | |
|-------------|----------|----|--------|
| 04316292181 | 30x22x44 | 10 | 01/004 |

inox satinado satin stainless steel
acero inoxidable satinado acier inoxydable satin



PAPELEIRA
bin papelera poubelle

| REF | (cm) | LT | |
|-------------|----------|----|--------|
| 0433660608 | Ø22.5x27 | 10 | 01/006 |
| 04339000012 | Ø22.5x27 | 10 | 01/020 |

revestimento em pvc pvc coating
revestimiento en pvc revêtement en pvc



CARROS de LIMPEZA/BALDES

cleaning cart/buckets carros de limpeza/cubos chariot de nettoyage/seaux



CESTO/PAPELEIRA
bin papelera poubelle

| REF | (cm) | |
|-------------|----------|--------|
| 0431629474 | Ø26.5x29 | 01/012 |
| 04316294741 | Ø23.5x27 | 01/012 |

cesto em rede metálica
basket in metal mesh
papelera en malla de metal
poubelle un treillis métallique



CESTO/PAPELEIRA
bin papelera poubelle

| REF | (cm) | |
|------------|----------|--------|
| 0731280479 | Ø23.5x28 | 01/020 |

cesto em rede metálica
basket in metal mesh
papelera en malla de metal
poubelle un treillis métallique



CESTO/PAPELEIRA
bin papelera poubelle

| REF | (cm) | |
|------------|----------|--------|
| 0731280478 | Ø26x26.3 | 01/020 |



PAPELEIRA C/CINZEIRO
bin with astray papelera con cenicero poubelle avec cendrier

| REF | (cm) | |
|------------|----------|--------|
| 0731280473 | Ø22x58.7 | 01/008 |



PAPELEIRA C/CINZEIRO
bin with astray papelera con cenicero poubelle avec cendrier

| REF | (cm) | LT | |
|------------|--------|----|--------|
| 0730377500 | Ø27x58 | 8 | 01/001 |



CINZEIRO C/PÉ
astray cenicero poubelle

| REF | (cm) | |
|------------|------------|--------|
| 0731280903 | Ø20.8x66.7 | 01/001 |



CINZEIRO PAREDE
wall astray cenicero mural poubelle cendrier mural

| REF | (cm) | |
|------------|-------------|--------|
| 0432930001 | 25.7x7.5x32 | 01/006 |



UTENSÍLIOS & MÁQUINAS

utensils and machines
utensilios y maquinaria
ustensiles et machines





UTENSÍLIOS & MÁQUINAS

utensils and machines utensilios y maquinaria ustensiles et machines



MOPAC/CABO

mop with cable mopa con cable raclette avec câble

| REF | (cm) | |
|---|------|--------|
| 0730371051 1 | 124 | 01/050 |
| 0730371054 2 | - | 01/050 |



VASSOURA

broom escoba balai

| REF | (cm) | |
|------------|---------------|--------|
| 0730370010 | 60x16.5x142.5 | 01/120 |



RODO C/CABO

squeegee with cable rodo con cable raclette avec câble

| REF | (cm) | |
|------------|------|--------|
| 0730374001 | 46 | 01/060 |



RODO C/CABO

squeegee with cable rodo con cable relette avec câble

| REF | (cm) | |
|------------|--------|--------|
| 0730370059 | 60x130 | 01/040 |



CABO EXTENSÍVEL

extensible cable cable extensible câble extensible

| REF | (cm) | |
|------------|---------|--------|
| 0730370130 | 130-240 | 01/130 |
| 0730370129 | 70-120 | 01/040 |

CABO

cable cable câble

| REF | (cm) | |
|------------|------|--------|
| 0732730000 | 140 | 01/012 |



CABO

cable cable câble

| REF | (cm) | |
|------------|------|--------|
| 0730750140 | 140 | 01/012 |

RECARGA ESFREGONA

refill mop recarga fregona recharge balai

| REF | (cm) | GR | |
|------------|------|-----|--------|
| 0731280045 | - | 180 | 01/048 |



RODO

squeegee rodo raclette

| REF | (cm) | |
|------------|------|--------|
| 0730376101 | 46 | 01/100 |
| 0730376103 | 36 | 01/100 |



RODO

squeegee rodo raclette

| REF | (cm) | |
|------------|------|--------|
| 0730376101 | 46 | 01/001 |



RODO

squeegee rodo raclette

| REF | (cm) | |
|------------|------|--------|
| 0730376101 | 46 | 01/001 |



PLÁSTICO
plastic

LAVA VIDROS C/RECARGA
window cleaner with refill
limpiador de vidrios con recarga
laveur de vitres avec recharge

| REF | (cm) | |
|-------------|------|--------|
| 0730376404 | 1 46 | 01/010 |
| 0730376403 | 36 | 01/010 |
| 07303764041 | 2 46 | 01/010 |



METAL

RODO
squeegee rodo raclette

| REF | (cm) | |
|------------|------|--------|
| 0731280003 | 55 | 01/010 |
| 0731280002 | 40 | 01/010 |



PLÁSTICO
plastic

RODO
squeegee rodo raclette

| REF | (cm) | |
|------------|------|--------|
| 0731280012 | 40 | 01/001 |



PLÁSTICO
plastic

RODO
squeegee rodo raclette

| REF | (cm) | |
|------------|------|--------|
| 0731280004 | 34 | 01/050 |



PLÁSTICO
plastic

RODO
window cleaner with sprayer
limpiador de vidrios con rociador
raclette vitres avec pulvérisateur

| REF | (cm) | |
|------------|------|--------|
| 0731280008 | 21 | 01/050 |



PEDRA LIMPA GRELHAS
cleaning stone grills
piedra para limpiar parrillas
pierre pour nettoyer les grilles

| REF | (cm) | |
|------------|-----------|--------|
| 0430723480 | 20.3x10x8 | 01/012 |

em fibra de vidro e polimnito de pedra
in fiber glass with stone polishing
en fibra de vidrio y pulimiento de piedra
en fibre de verre et polissage de pierre



ESFREGÃO
scourer estropajo éponge

| REF | (cm) | |
|------------|-------|--------|
| 0430726906 | 23x15 | 01/040 |



ABS

RASPADOR P/VITROCERÂMICA
scraper for glass-ceramic
raspador para vitrocerâmica
grattoir pour la vitroceramique

| REF | (cm) | |
|-----------|------|--------|
| 043270501 | 21 | 01/100 |



METAL PLÁSTICO
plastic

RASPADOR P/VITROCERÂMICA
scraper for glass-ceramic
raspador para vitrocerâmica
grattoir pour la vitroceramique

| REF | (cm) | |
|------------|--------|--------|
| 0730376305 | 14x4.5 | 01/100 |



METAL PLÁSTICO
plastic

ESCOVA CHURRASCO
barbecue brush cepillo de barbacoa brosse barbecue

| REF | (cm) | |
|------------|------|--------|
| 0432270107 | 45 | 01/024 |



ESCOVA LAVAR COPOS
brush escoba brosse

| REF | (cm) | |
|------------|---------------|--------|
| 0430720095 | 18.5x9.5x19.5 | 01/010 |



UTENSÍLIOS & MÁQUINAS

utensils and machines utensillos y maquinaria ustensiles et machines



MÁQUINA LAVAR CHÃO

washing machine floor lavadora de piso monobrosse

| REF | (cm) | |
|------------|---------|--------|
| 0730370522 | Ø40x119 | 01/001 |

MODELO model modelo modèle **BF522**
PESO weight peso poids **74KG**
VELOCIDADE speed velocidad vitesse **175RPM**
VOLTAGEM voltage voltaje voltage **220V**
FREQUÊNCIA frequency frecuencia fréquence **50HZ**
POTÊNCIA power potencia puissance **1.2KW**



DEPÓSITO ÁGUA

water tank depósito de agua dépôt pour léau

| REF | (cm) | LT | |
|-------------|----------|----|--------|
| 07303705221 | 50x21x19 | 8 | 01/004 |



ESCOVA P/CARPETES

carpet brush escoba para carpetas brosses pour moquettes

| REF | (cm) | |
|------------|------|--------|
| 0730379204 | Ø40 | 01/001 |



ESCOVA P/PAVIMENTOS

floor brush escoba para pisos brosses pour étages

| REF | (cm) | |
|------------|------|--------|
| 0730379205 | Ø40 | 01/001 |



SUPORTE D/ESCOVAS

brush stand suporte para escobas support pour brosses

| REF | (cm) | |
|------------|------|--------|
| 0730379206 | Ø40 | 01/001 |



MÁQUINA ENGRAXAR SAPATOS

shoe polishing máquina lustradora de zapatos cireuse lustreuse chaussures

| REF | (cm) | |
|--------------|------------|--------|
| 13302911051* | 80x60x81 | 01/001 |
| 1330291105 | 80x47x81 | 01/001 |
| 13302910161 | 32x8x80 | 01/004 |
| 1330291016 | 46x29.5x30 | 01/001 |

*com moedeiro with coin operated con monedero avec monnayeur





HIGIENE & PROTECÇÃO

hygiene and protection

higiene y protección

hygiène et protection





CESTOS DE LIMPEZA

dishwasher racks cestas para vajilla paniers à vaisselle

Os cestos permitem uma limpeza mais eficiente, poupam tempo e reduzem custos.

São empilháveis, estão adaptados à maior parte dos cestos existentes no mercado.

A superfície texturada reduz os riscos que tendem a aparecer com a utilização.

As 4 pegas laterais existentes oferecem conforto e segurança no manuseamento e transporte dos cestos.

O sistema de encaixe é suficientemente forte para que as extensões não se soltem, por outro lado têm a vantagem de não enferrujar como os parafusos normais. Este sistema permite a lavagem perfeita dos copos desde o topo até à base passando pelas superfícies interiores e exteriores.

Permite também uma maior circulação do ar entre os cestos, fazendo com que sequem mais rapidamente e permitindo um armazenamento mais seguro.

Baskets allow more efficient cleaning, save time and reduce costs.

They are stackable, they are adapted to most of the baskets in the market.

The textured surface reduces the risks that tend to appear with the use.

The 4 existing side handles offer comfort and safety when handling and transporting the baskets.

The docking system is strong enough so that the extensions do not come loose, on the other hand they have the advantage of not rusting like the normal screws. This system allows the perfect washing of the cups from the top to the base through the inner and outer surfaces.

It also allows more air circulation between the baskets, making them dry faster and allowing safer storage.

Las cestas permiten una limpieza más eficiente, ahorrar tiempo y reducir costos.

Son apilables, se adaptan a la mayoría de las cestas existentes en el mercado.

La superficie con textura reduce los riesgos que tienden a aparecer con utilización.

Los cuatro asideros laterales existentes proporcionan comodidad y seguridad en la manipulación y el transporte de los cestos.

El sistema de bloqueo es lo suficientemente fuerte para que las extensiones no se suelten por otro lado tienen la ventaja de no oxidarse como tornillos normales. Este sistema permite un lavado a fondo de las copas de la parte superior a la parte inferior pasando a través de las superficies interior y exterior.

También permite una mayor circulación de aire entre las cestas, provocando que se seque más rápidamente y permite el almacenamiento más seguro.

Les paniers permettent un nettoyage plus efficace, un gain de temps et réduisent les coûts. Sont empilables, adaptés à la plupart des paniers existants sur le marché. La surface texturée réduit les risques qui ont tendance à apparaître avec leur utilisation. Les quatre poignées latérales offrent un confort et une sécurité pendant la manipulation et le transport des paniers. Le système de fixation est suffisamment fort pour que les extensions ne lâchent pas, d'autre part, il a l'avantage de ne pas rouiller pas comme les vis habituelles. Ce système permet un lavage parfait des verres, du haut vers le bas, en passant par les surfaces intérieures et extérieures. Il permet également une plus grande circulation d'air entre les paniers, permettant un séchage plus rapide et un stockage plus sécurisé.

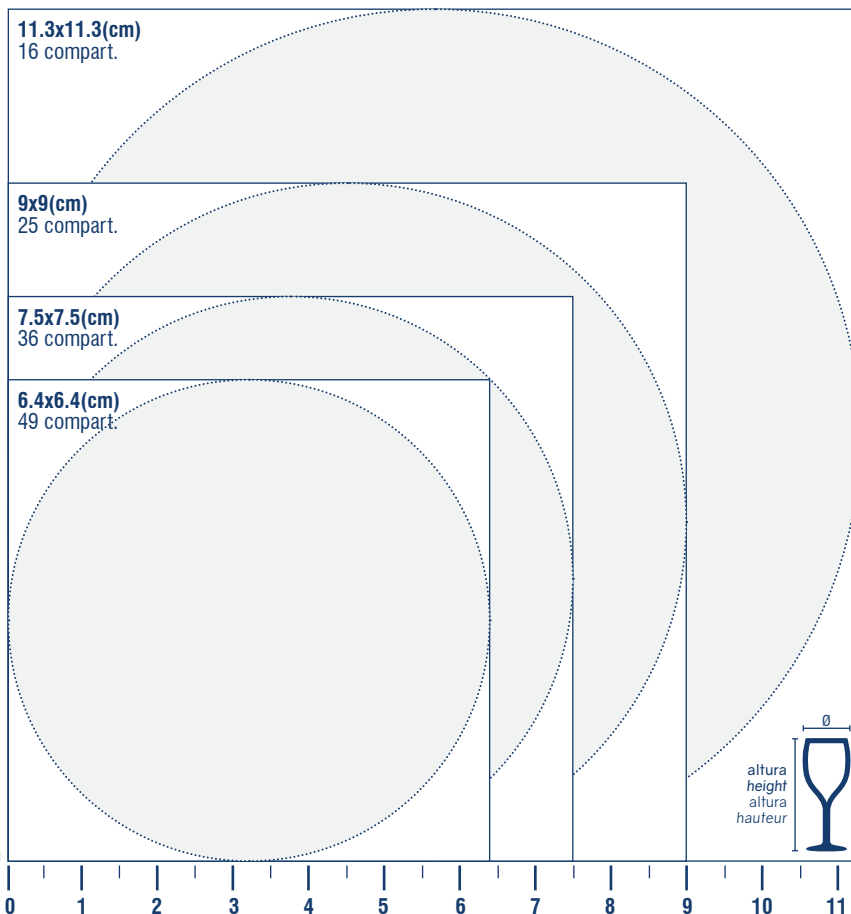

Como escolher o cesto correcto?

1) Medir a altura total do copo, desde a base até ao bordo.

2) Medir os diâmetros da base e do bordo (escolha o diâmetro maior). Os círculos servem para ajudar a medir o diâmetro dos copos para definir o número de compartimentos.

How to choose the right basket?

1) Measure the total height of the glass, from the base to the edge.

2) Measure the base and edge diameters (choose the largest diameter). The circles serve to help measure the diameter of the cups to define the number of compartments.

¿Cómo elegir el derecho cesta?

1) Para medir el tamaño total del vaso, desde la base hasta el borde.

2) Medir el diámetro de la base y la placa (elegir el diámetro mayor). Los círculos se utilizan para ayudar a medir el diámetro de los vasos para establecer el número de compartimentos.

Comment choisir le bon panier?

1) afin de mesurer la taille totale du verre, depuis la base jusqu'au bord.

2) Mesurer le diamètre de la base (choisir le plus grand diamètre). Les cercles sont utilisés pour mesurer les verres et définir le nombre de compartiments.

25

pinos pegs pinos tigs

**64**

pinos pegs pinos tigs

**CESTO P/TALHERES**

cutlery racks cesta para cubiertos panier à couverts

| REF | (cm) | |
|------------|----------|--------|
| 0730266000 | 50x50x10 | 01/006 |

**CESTO P/PRATOS**

plate racks cesta para platos panier pour assiettes

| REF | (cm) | |
|-------------|----------|--------|
| 07302600254 | 50x50x10 | 01/006 |

**CESTO P/PRATOS**

plate racks cesta para platos panier pour assiettes

| REF | (cm) | |
|------------|----------|--------|
| 0730260064 | 50x50x10 | 01/006 |

**9**

compart.

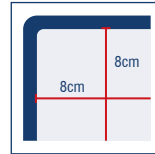
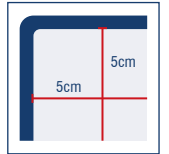
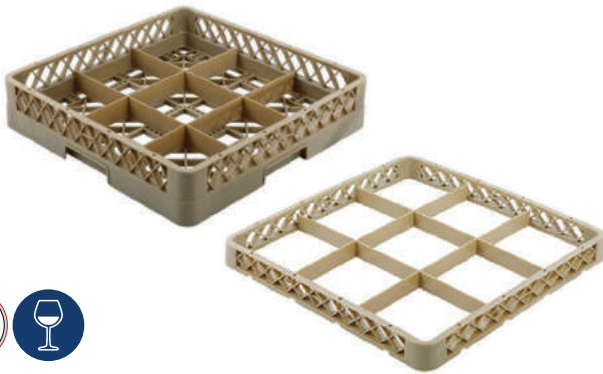
**CESTO P/COPOS**

glass racks cesta para tazas panier pour verres

| REF | (cm) | |
|-------------|----------|--------|
| 07302600092 | 50x50x10 | 01/006 |

EXTENSÃO

extension extensión extension

| REF | (cm) | |
|-------------|-----------|--------|
| 07302600092 | 50x50x4.5 | 01/006 |

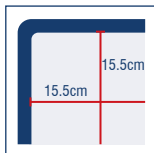
**16**

compart.

**CESTO P/COPOS**

glass racks cesta para tazas panier pour verres

| REF | (cm) | |
|------------|----------|--------|
| 0730260016 | 50x50x10 | 01/006 |

EXTENSÃO

extension extensión extension

| REF | (cm) | |
|-------------|-----------|--------|
| 07302600162 | 50x50x4.5 | 01/006 |

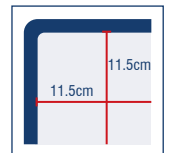
**25**

compart.

**CESTO P/COPOS**

glass racks cesta para tazas panier pour verres

| REF | (cm) | |
|------------|----------|--------|
| 0730260025 | 50x50x10 | 01/006 |

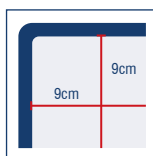
**EXTENSÃO**

extension extensión extension

| REF | (cm) | |
|-------------|-----------|--------|
| 07302600253 | 50x50x4.5 | 01/012 |

**EXTENSÃO**

extension extensión extension

| REF | (cm) | |
|-------------|---------|--------|
| 07302600252 | 50x50x7 | 01/006 |



36

compart.

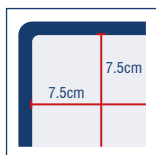

CESTO P/COPOS
 glass racks cesta para tazas panier pour verres

| REF | (cm) | |
|------------|----------|--------|
| 0730260036 | 50x50x10 | 01/006 |



EXTENSÃO
 extension extensión extension

| REF | (cm) | |
|-------------|-----------|--------|
| 07302600363 | 50x50x4.5 | 01/012 |



EXTENSÃO
 extension extensión extension

| REF | (cm) | |
|-------------|---------|--------|
| 07302600362 | 50x50x7 | 01/006 |

49

compart.

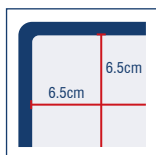

CESTO P/COPOS
 glass racks cesta para tazas panier pour verres

| REF | (cm) | |
|------------|----------|--------|
| 0730260049 | 50x50x10 | 01/006 |



EXTENSÃO
 extension extensión extension

| REF | (cm) | |
|-------------|-----------|--------|
| 07302600492 | 50x50x4.5 | 01/012 |



EXTENSÃO
 extension extensión extension

| REF | (cm) | |
|------------|-----------|--------|
| 0730260000 | 50x50x4.5 | 01/006 |

64

pinos pegs pinos tigs

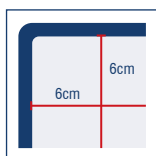

CESTO P/TABULEIROS
 plate racks cesta para pratos panier pour assiettes

| REF | (cm) | |
|-------------|----------|--------|
| 07302600641 | 50x50x10 | 01/006 |

08

compart.



CESTO P/TALHERES
 cutlery racks cesta para cubiertos panier à couverts

| REF | (cm) | |
|------------|----------|--------|
| 0730260008 | 43x21x15 | 01/016 |

08

compart.



CESTO P/TALHERES
 cutlery racks cesta para cubiertos panier à couverts

| REF | (cm) | |
|------------|--------------|--------|
| 0732960211 | 41.5x21.4x15 | 01/015 |



PP

MARCADORES P/CESTOS

markers for racks
 marcadores para cestas
 marqueurs pour identifier

| REF | (cm) |  |
|------------|------------|--|
| 0730260007 | 10.8x4.8x2 | 06/012 |

marcadores para identificar os cestos por secção ou funcionalidade e mantenha tudo organizado
 markers identify baskets by section or functionality and keep everything organized
 marcadores identificación cestas por sección o funcionalidad y mantener todo organizado
 marqueurs pour identifier les paniers par section ou fonction et maintenir le tout organisé



PP

TAMPA P/CESTOS

racks lid tapa para cesta couvercle pour casier

| REF | (cm) |  |
|------------|---------------|---|
| 0730260008 | 50.5x50.5x2.6 | 01/036 |

PP INOX

CARRO P/CESTOS

trolley for racks carro para cestas chariot pour casiers

| REF | (cm) |  |
|-------------|----------|---|
| 07336100011 | 54x54x80 | 01/001 |



PP INOX

CARRO P/CESTOS

trolley for racks carro para cestas chariot pour casiers

| REF | (cm) |  |
|------------|----------|---|
| 0430684011 | 73x49x86 | 01/001 |





HIGIENE & PROTEÇÃO

hygiene and protection higiene y protección hygiène et protection



DISPENSADOR PAPEL JUMBO

paper dispenser dispensador papel distributeur de papier

| REF | (cm) | |
|------------|----------|--------|
| 0731280165 | Ø25x12.5 | 01/008 |



DISPENSADOR MINI PAPEL JUMBO

paper dispenser dispensador papel distributeur de papier

| REF | (cm) | |
|------------|--------|--------|
| 0731280635 | Ø22x12 | 01/030 |



DISPENSADOR PAPEL JUMBO

paper dispenser dispensador papel distributeur de papier

| REF | (cm) | |
|-------------|--------------|--------|
| 07339603401 | 12x25.8x26.6 | 01/100 |



DISPENSADOR PAPEL JUMBO

paper dispenser dispensador papel distributeur de papier

| REF | (cm) | |
|------------|--------|--------|
| 0430720072 | Ø37x14 | 01/103 |



DISPENSADOR TOALHAS

paper dispenser dispensador papel distributeur de papier

| REF | (cm) | |
|------------|-------|--------|
| 0731280044 | 27x32 | 01/006 |



DISPENSADOR TOALHAS

paper dispenser dispensador papel distributeur de papier

| REF | (cm) | |
|------------|--------------|--------|
| 0732090418 | 31.5x24.5x30 | 01/003 |



DISPENSADOR TOALHAS

paper dispenser dispensador papel distributeur de papier

| REF | (cm) | |
|------------|----------|--------|
| 0732090408 | 28x14x32 | 01/006 |



1



2



DISPENSADOR TOALHAS CHAMINÉ

paper dispenser dispensador papel distributeur de papier

| REF | (cm) | |
|-------------|----------------|--------|
| 0733960330 | 1 21.3x21x35.6 | 01/100 |
| 07339603301 | 2 21.3x21x35.6 | 01/100 |

ABS

DISPENSADOR TOALHAS
paper dispenser dispensador papel distributeur de papier

| REF | (cm) | |
|---------------------|---------|--------|
| 0731280070 1 | 25x9x29 | 01/012 |
| 0731280090 2 | 25x9x29 | 01/012 |

1**2****1****2**

DISPENSADOR TOALHAS EM Z
paper dispenser dispensador papel distributeur de papier

| REF | (cm) | |
|----------------------|-----------|--------|
| 07312800702 1 | 26x9.5x20 | 01/012 |
| 0731280177 2 | 26x9.5x23 | 01/012 |

INOX

DISPENSADOR TOALHAS EM Z
paper dispenser dispensador papel distributeur de papier

| REF | (cm) | |
|------------|-----------|--------|
| 0731280632 | 25.8x9x20 | 01/030 |
| 0731280633 | 25.8x9x28 | 01/030 |

INOX

DISPENSADOR SABONETE
soap dispenser dispensador jabón distributeur à savon

| REF | (cm) | ML | |
|------------|------------|-----|--------|
| 0731280675 | 10x10x15.5 | 500 | 01/020 |

ABS

DISPENSADOR SABÃO
soap dispenser dispensador jabón distributeur à savon

| REF | (cm) | LT | |
|------------|-------------|-----------|--------|
| 0731280038 | 20.5x7.5x18 | 0.35 (2X) | 01/012 |

ABS SAN

DISPENSADOR ESPUMA
soap dispenser dispensador jabón distributeur à savon

| REF | (cm) | LT | |
|------------|-------------|------|--------|
| 0731280073 | 11x8.5x19.5 | 0.65 | 01/024 |

DISPENSADOR SABONETE
soap dispenser dispensador jabón distributeur à savon

| REF | (cm) | ML | |
|------------|-----------|---------|--------|
| 0731280029 | 20x9x18.5 | 350+350 | 01/012 |

1**2**

DISPENSADOR SABONETE
soap dispenser dispensador jabón distributeur à savon

| REF | (cm) | ML | |
|---------------------|---------------|-----|--------|
| 0731280015 1 | 16x9x9 | 350 | 01/024 |
| 0731280011 | 19.5x10.7x9.5 | 650 | 01/024 |
| 0731280017 2 | 16x9x9 | 350 | 01/024 |
| 0731280016 | 19.5x10.7x9.5 | 650 | 01/024 |

ABS SAN

DISPENSADOR ESPUMA
soap dispenser dispensador jabón distributeur à savon

| REF | (cm) | LT | |
|---------------------|-------------|-----|--------|
| 0731280049 1 | 13.5x6.5x21 | 0.5 | 01/024 |
| 0731280058 2 | 13.5x6.5x21 | 0.5 | 01/024 |

ABS

DISPENSADOR ESPUMA
soap dispenser dispensador jabón distributeur à savon

| REF | (cm) | ML | |
|------------|-------------|-----|--------|
| 0733960072 | 11.4x9.8x21 | 750 | 01/480 |

ABS**1****2**

DISPENSADOR SABONETE
soap dispenser dispensador jabón distributeur à savon

| REF | (cm) | ML | |
|---------------------|---------------|------|--------|
| 0733960064 1 | 10.1x9.3x20.9 | 500 | 01/720 |
| 0733960065 2 | 10.1x9.3x20.9 | 1000 | 01/720 |



HIGIENE & PROTECÇÃO

hygiene and protection higiene y protección hygiène et protection



TAPETE
carpet alfombra tapis

| REF | (cm) | KG | |
|-------------|------------|------|--------|
| 07320200032 | 100x50x1.6 | 2.28 | 01/003 |



TAPETE
carpet alfombra tapis

| REF | (cm) | KG | |
|-------------|-----------|-----|--------|
| 07320200031 | 60x40x1.2 | 0.9 | 01/010 |



PP

ESTRADO
toilet mat estrado estrade

| REF | (cm) | |
|-------------|-------------|--------|
| 07302600006 | 33.5x33.5x4 | 01/012 |



com encaixe with fitting
con enclavamiento avec montage



SINALÉTICA
signal indicadores signalétique

| REF | (cm) | |
|------------|------|--------|
| 0430683904 | Ø7.5 | 50/200 |
| 0430683902 | Ø7.5 | 50/200 |
| 0430683901 | Ø7.5 | 50/200 |



índice alfabético

alphabetical index índice alfabético *index alphabétique*



| | |
|-----------------------------------|------------------|
| A | |
| abre latas | 78 |
| acessório ravioli | 74 |
| açucareiros | 227-228 |
| adaptador placa de indução | 18 |
| agitadores cocktail | 286 |
| alçados/prateleiras | 316 |
| alisador fondant | 83 |
| almofariz | 60-61 |
| almotolia | 185 |
| amassadeiras | 296 |
| anilha anti-gota | 269 |
| apanha migalhas | 253 |
| aquecedor de pratos | 313 |
| aquecedor jardim | 321 |
| ardósia natural | 192 |
| armário frigorífico | 313 |
| aros inox | 93 |
| aventais | 325 |
| B | |
| balanças | 62 |
| balde (dejetos) | 64 |
| baldes (alimentos) | 64 |
| baldes gelo/suportes | 258-261 |
| baldes limpeza | 333 |
| baldes lixo | 334-335 |
| bancadas/ bancadas refrigeradoras | 310-317 |
| bandejas | 274 |
| banho maria | 231, 309, 318 |
| barra de pedidos | 52 |
| base pizza | 37 |
| bases bambu | 220 |
| bafedeiras | 296-297 |
| bafeador elétrico (bar) | 265 |
| bicos pasteleiro/sacos e suporte | 94-96 |
| bivaque pasteleiro | 325 |
| bolsa utensílios (decoradores) | 66 |
| bomba vácuo | 269 |
| bules | 138-139, 276-277 |
| C | |
| cabos (limpeza) | 338 |
| caçarolas | 10-17, 24-25 |
| caçaroletes | 11, 13, 18, 80 |
| cadeiros para jardim | 321 |
| cadeira bebé | 320 |
| cafeteiras | 277-278 |
| cafeteiras termos | 249-250 |
| caixa dreno | 272 |
| caixa insonorização | 295 |
| caixa p/pizza | 37 |
| caixas para chá | 279 |
| caixas/cubas p/alimentos/marmitta | 63, 181 |
| calçado | 327 |
| calças | 325 |
| cálices/copos | 154-172 |
| campainha | 274 |
| câmpanulas/cloches | 186, 209-217 |
| candeeiros para jardim | 321 |
| canecas cerveja | 140, 171, 271 |
| canecas com tampa | 142 |
| canecas vidro | 141-142 |
| carro lona | 332 |
| carros (cestos limpeza) | 345 |
| carros (GN) | 243 |
| carros (tabuleiros) | 243 |
| carros de limpeza | 332-333 |
| carros serviço | 244-245 |
| centrifugadora | 57 |
| cestos | 213-218 |
| cestos (cozer a vapor) | 56 |

| | |
|---------------------------------|---------------|
| cestos (limpeza) | 342-344 |
| cestos (tacos) | 56 |
| cestos (talheres) | 344 |
| cestos/papeleira | 335-336 |
| chafing dish | 228-230 |
| champanheira | 260 |
| chapas eléctricas | 301 |
| chávenas/pires vidro | 142 |
| cinzeiro parede | 336 |
| cinzeiros | 280-281 |
| coador (chá) | 278 |
| coadores (bar) | 264-265 |
| coadores (cozinha) | 57-58 |
| colher mel | 178 |
| colheres (bar) | 265-266 |
| colheres degustação | 130 |
| colheres esparguete | 41, 43-44 |
| colheres gelado | 97 |
| colheres servir | 40-45, 219 |
| coluna móvel | 255 |
| conchas | 39-44 |
| conchas acrílicas | 225 |
| conjunto utensílios (massa) | 93 |
| conjuntos Bife na pedra | 182 |
| contentores GN (inox) | 235-239 |
| contentores GN (melamina) | 201-202 |
| contentores GN (PC) | 240-241 |
| contentores GN (PP) | 242 |
| copos/baldes servir | 178-179 |
| corda separadora | 255 |
| corredores (cozinha) | 54 |
| corredores de gelo | 262 |
| corta massa (pastelaria) | 84 |
| corta massas | 75, 84, 91-93 |
| corta ovos | 73 |
| corta pizza | 75 |
| cortador feijão verde | 73 |
| cortador tomate | 73 |
| cortador/nivelador bolos | 84 |
| crepeira | 306 |
| cuba/panela | 231 |
| D | |
| decanter | 176 |
| decoradores | 66 |
| depósito cápsulas | 270 |
| descaroçadores | 67 |
| descartáveis (aventais) | 289 |
| descartáveis (copos) | 284-285 |
| descartáveis (embalagem) | 285-286 |
| descartáveis (luvas) | 289 |
| descartáveis (máscaras) | 289 |
| descartáveis (palitos/espertos) | 287 |
| descartáveis (talheres) | 286 |
| descascadores | 67-68, 298 |
| desidratador de alimentos | 306 |
| dispensador de frutos secos | 212 |
| dispensador palhinhas | 275 |
| dispensadores café | 225 |
| dispensadores cereais | 212 |
| dispensadores espuma | 347 |
| dispensadores leite | 224 |
| dispensadores líquidos | 223-224 |
| dispensadores molhos | 87 |
| dispensadores sumo | 224 |
| dispensadores toalhas | 346-347 |
| doseadores (bar) | 273 |
| doseadores (pastelaria) | 87 |
| E | |
| electrocutores | 320 |
| ementas | 253 |

| | |
|----------------------------------|----------------------|
| escamadores | 76 |
| escorredores | 56-57 |
| escova churrasco | 339 |
| escova lavar copos | 339 |
| escumadeira (arame/rede) | 39 |
| escumadeiras | 39-44 |
| esfregão | 339 |
| esmagadores alho | 60 |
| esmagadores batatas | 59-60 |
| espátulas (confeitaria) | 82 |
| espátulas (cozinha) | 49-50 |
| esperto pedido | 253 |
| espertos | 180-181 |
| espremedores citrinos | 61, 266 |
| espremedores citrinos eléctricos | 294 |
| estrado | 248 |
| estufa para alimentos | 312 |
| expositores | 87, 211 |
| expositores vidro | 211 |
| F | |
| faca ostra | 76 |
| faca pizza | 75 |
| facas | 75 |
| fatiador enchidos/vegetais | 298 |
| filtro chá | 278 |
| finger food | 226 |
| fogão | 305 |
| fondue | 181 |
| fonte chocolate | 307 |
| forma (laminar bolos) | 85 |
| forma muffins | 125 |
| formas (bolos) | 89, 90 |
| formas (papel) | 287 |
| formas p/pizza | 37 |
| forno convertor | 305 |
| fornos pizza | 306 |
| frappés | 225 |
| frascos com suportes | 211 |
| frascos vidro | 148 |
| frigideiras | 11, 13, 15-16, 29-30 |
| frigideiras ferro fundido | 26-27 |
| frigideiras/cestos servir | 179 |
| fritadeiras | 303-305 |
| fruteiros | 203 |
| fundos perfurados | 239 |
| funil | 58 |
| funil confeitaria | 80-81 |
| fuzil | 76 |
| G | |
| galhetas | 184-185 |
| galheteiros | 184 |
| ganchos | 52, 181 |
| garfo marisco | 178 |
| garfos trinchar | 39, 42-44 |
| garrafa "FLAIR" FBA | 273 |
| garrafa refrigeradora | 223 |
| garrafas (molhos) | 59 |
| garrafas (vidro) | 142, 176 |
| garrafas com vertedores | 273 |
| gel combustível | 232 |
| glass rimmer | 267 |
| grelhadores | 31 |
| grelhadores contacto | 301 |
| grelhadores HOT DOG | 301 |
| grelhas inox | 35 |
| grelhas pastelaria | 86 |
| guia divisória | 239 |
| I | |
| individuais/expositor | 187 |
| infusor chá | 278 |



| | | | | | |
|--|---------------|----------------------------------|----------------|------------------------------------|--------------|
| isqueiro | 62 | picadores gelo | 262 | rolos cozinha | 83 |
| J | | pilão | 266 | S | |
| jalecas | 324 | pinças churrasco | 47-48 | saca rolhas | 269 |
| jarros (bar) | 271 | pinças empilhar | 46 | saladeiras inox | 55 |
| jarros acrílico | 222-223 | pinças gelo | 261 | saladeiras PC/AS | 147 |
| jarros medidores | 54, 80 | pinças servir | 46-47, 218-219 | saladeiras porcelana | 120 |
| jarros porcelana | 140 | pinças tabuleiro | 36 | saladeiras vidro | 147 |
| jarros vidro | 174-176 | pinçais | 82 | saleiro/pimenteiro | 182-184 |
| L | | placa informativa (chão molhado) | 333 | separador claras | 81 |
| laminador gelo | 298 | placa p/saco chá | 140 | seringa (molhos) | 59 |
| lâmpadas de aquecimento | 233 | placards decorativos | 255 | seringa pasteleiro | 94 |
| lâmpadas para gel | 232 | placas (chá quente, café, leite) | 250 | serra ossos | 298 |
| leiteiras | 278 | placas aquecedoras | 231 | sertã | 15 |
| lenços | 325 | placas arrefecimento | 231 | shakers | 263-264 |
| limpa vidros | 339 | placas eléctricas | 232 | sifão natas | 93 |
| liquidificadores | 294-295 | placas numéricas | 252 | sinalética wc | 348 |
| luvas (forno) | 36 | placas precário | 252 | suporte (pacote leite) | 278 |
| M | | placas RESERVADO | 252 | suporte colheres | 219, 232 |
| maçarico pastelaria/recargas | 87 | polvilhadores | 88 | suporte cones | 179 |
| madeira/bambu (artigos) | 220 | poncheira | 225 | suporte copos | 272 |
| mandolinas | 72 | porcelana (assadeiras) | 115 | suporte magnético (facas) | 76 |
| mangas refrigeradoras | 225 | porcelana (caçarolas) | 114 | suporte para tabuleiros | 37 |
| manteigueira | 184 | porcelana (canecas) | 140 | suporte talheres | 221 |
| máquina cones | 309 | porcelana (chávenas/pires) | 131-137 | suporte/ganchos para garrafas | 270 |
| máquina enchidos | 74 | porcelana (contentores) | 203 | suportes espetadas | 180 |
| máquina engraxar sapatos | 340 | porcelana (frigideiras) | 114-115 | suportes menu | 252 |
| máquina estender massa | 74 | porcelana (porta aperitivos) | 126-129 | T | |
| máquina fazer waffles | 306 | porcelana (tábuas) | 192 | tábuas de apresentação | 192-193 |
| máquina gelo | 299 | porcelana (tarteira) | 115 | tábuas de corte/suportes | 77-78 |
| máquina hamburguers | 74 | porcelana (tigelas/faças) | 120-124 | tabuleiro p/chafing dish | 229 |
| máquina lavar chão/acessórios | 340 | porcelana (torteira) | 117 | tabuleiro p/talheres | 51, 221 |
| máquina palitar batatas | 72-74 | porcelana (travessas sushi) | 118 | tabuleiros forno | 33-35 |
| máquina pão HOT DOG | 301 | porcelana (travessas) | 116-119 | tabuleiros self-service | 243 |
| marcador (bolos) | 85 | porta condimentos | 267 | tabuleiros servir | 205 |
| marcadores (cestos) | 345 | porta contas | 252 | taças sobremesa | 143-146 |
| martelos | 60 | porta guardanapos | 275 | talheres /talheres para aperitivos | 150-152, 220 |
| mazagran | 140 | porta ovos | 186 | tampa ajustável | 18 |
| medidores (bar) | 272 | porta palhinhas | 275 | tampas GN | 238-239 |
| medidores (pastelaria) | 81 | porta talheres | 51 | tapetes balcão | 272 |
| melaminas | 193-202 | pratos (ferro fundido) | 27 | tapetes borracha | 348 |
| menus (figuras) | 254-255 | pratos bife | 111 | tapetes silicone | 86 |
| misturador de bebidas | 295 | pratos bolos | 148 | temporizador | 62 |
| misturadores cocktail | 286 | pratos com tampa | 207-208 | tenazes | 48 |
| moinhos pimenta/sal | 183 | pratos Coupe Hotel | 105 | termómetros | 62 |
| molas (toalhas mesa) | 253 | pratos diversos | 110-111 | termos | 249 |
| moldes (bombons) | 93 | pratos Filados | 108 | termos eléctricos | 248-249 |
| moldes (hamburger) | 60 | pratos Hotel (relevô) | 109 | termotrans | 246 |
| moldes (ovos) | 54 | pratos Hotel N | 104 | terrinas inox | 204 |
| moldes (rissóis) | 60 | pratos inox | 181 | tesouras | 76 |
| molheiras | 185 | pratos Lagos | 106 | tigelas/saladerias inox | 54-55 |
| mopas | 338 | pratos marcadores | 112 | tira cápsulas | 269-270 |
| N | | pratos Óbidos | 102 | torradeiras | 302-303 |
| naperons papel | 288 | pratos pasta/risotto | 111 | travessas/bandejas inox | 204-206 |
| ninho de arame | 56 | pratos pizza | 111-112 | tulha | 272 |
| O | | pratos Snack | 107 | V | |
| organizer | 274-275 | pratos Tokio | 103 | varas batedoras | 81-82 |
| P | | pratos Trocos | 253 | vertedores/ suporte rotativo | 272-273 |
| pá (batatas fritas) | 56 | pratos diversos | 110-111 | vitřines | 209-210, 217 |
| pá pizza | 37 | pratos Óbidos | 102 | vitřines aquecedoras | 309 |
| paelheiras | 11, 29 | pratos pasta/risotto | 111 | vitřines refrigeradoras | 309-312 |
| panelas | 10, 13-15, 18 | pratos pizza | 111-112 | W | |
| panelas (eléct.) / panelas (lâmparina) | 230-231 | pratos Snack | 107 | woks | 11, 17, 24 |
| panelas de pressão/acessórios | 20-22 | pratos Tokio | 103 | | |
| panelas termo | 247 | pratos Trocos | 253 | | |
| passé-vite | 59 | pratos diversos | 110-111 | | |
| pauzinhos pop cakes | 287 | pratos Óbidos | 102 | | |
| pedra limpa grelhas | 339 | pratos pasta/risotto | 111 | | |
| peneiras | 81 | pratos pizza | 111-112 | | |
| pias | 317 | pratos Snack | 107 | | |
| picadores carne | 73, 297-298 | pratos Tokio | 103 | | |
| | | pratos Trocos | 253 | | |
| | | pratos diversos | 110-111 | | |
| | | pratos Óbidos | 102 | | |
| | | pratos pasta/risotto | 111 | | |
| | | pratos pizza | 111-112 | | |
| | | pratos Snack | 107 | | |
| | | pratos Tokio | 103 | | |
| | | pratos Trocos | 253 | | |
| | | pratos diversos | 110-111 | | |
| | | pratos Óbidos | 102 | | |
| | | pratos pasta/risotto | 111 | | |
| | | pratos pizza | 111-112 | | |
| | | pratos Snack | 107 | | |
| | | pratos Tokio | 103 | | |
| | | pratos Trocos | 253 | | |
| | | pratos diversos | 110-111 | | |
| | | pratos Óbidos | 102 | | |
| | | pratos pasta/risotto | 111 | | |
| | | pratos pizza | 111-112 | | |
| | | pratos Snack | 107 | | |
| | | pratos Tokio | 103 | | |
| | | pratos Trocos | 253 | | |
| | | pratos diversos | 110-111 | | |
| | | pratos Óbidos | 102 | | |
| | | pratos pasta/risotto | 111 | | |
| | | pratos pizza | 111-112 | | |
| | | pratos Snack | 107 | | |
| | | pratos Tokio | 103 | | |
| | | pratos Trocos | 253 | | |
| | | pratos diversos | 110-111 | | |
| | | pratos Óbidos | 102 | | |
| | | pratos pasta/risotto | 111 | | |
| | | pratos pizza | 111-112 | | |
| | | pratos Snack | 107 | | |
| | | pratos Tokio | 103 | | |
| | | pratos Trocos | 253 | | |
| | | pratos diversos | 110-111 | | |
| | | pratos Óbidos | 102 | | |
| | | pratos pasta/risotto | 111 | | |
| | | pratos pizza | 111-112 | | |
| | | pratos Snack | 107 | | |
| | | pratos Tokio | 103 | | |
| | | pratos Trocos | 253 | | |
| | | pratos diversos | 110-111 | | |
| | | pratos Óbidos | 102 | | |
| | | pratos pasta/risotto | 111 | | |
| | | pratos pizza | 111-112 | | |
| | | pratos Snack | 107 | | |
| | | pratos Tokio | 103 | | |
| | | pratos Trocos | 253 | | |
| | | pratos diversos | 110-111 | | |
| | | pratos Óbidos | 102 | | |
| | | pratos pasta/risotto | 111 | | |
| | | pratos pizza | 111-112 | | |
| | | pratos Snack | 107 | | |
| | | pratos Tokio | 103 | | |
| | | pratos Trocos | 253 | | |
| | | pratos diversos | 110-111 | | |
| | | pratos Óbidos | 102 | | |
| | | pratos pasta/risotto | 111 | | |
| | | pratos pizza | 111-112 | | |
| | | pratos Snack | 107 | | |
| | | pratos Tokio | 103 | | |
| | | pratos Trocos | 253 | | |
| | | pratos diversos | 110-111 | | |
| | | pratos Óbidos | 102 | | |
| | | pratos pasta/risotto | 111 | | |
| | | pratos pizza | 111-112 | | |
| | | pratos Snack | 107 | | |
| | | pratos Tokio | 103 | | |
| | | pratos Trocos | 253 | | |
| | | pratos diversos | 110-111 | | |
| | | pratos Óbidos | 102 | | |
| | | pratos pasta/risotto | 111 | | |
| | | pratos pizza | 111-112 | | |
| | | pratos Snack | 107 | | |
| | | pratos Tokio | 103 | | |
| | | pratos Trocos | 253 | | |
| | | pratos diversos | 110-111 | | |
| | | pratos Óbidos | 102 | | |
| | | pratos pasta/risotto | 111 | | |
| | | pratos pizza | 111-112 | | |
| | | pratos Snack | 107 | | |
| | | pratos Tokio | 103 | | |
| | | pratos Trocos | 253 | | |
| | | pratos diversos | 110-111 | | |
| | | pratos Óbidos | 102 | | |
| | | pratos pasta/risotto | 111 | | |
| | | pratos pizza | 111-112 | | |
| | | pratos Snack | 107 | | |
| | | pratos Tokio | 103 | | |
| | | pratos Trocos | 253 | | |
| | | pratos diversos | 110-111 | | |
| | | pratos Óbidos | 102 | | |
| | | pratos pasta/risotto | 111 | | |
| | | pratos pizza | 111-112 | | |
| | | pratos Snack | 107 | | |
| | | pratos Tokio | 103 | | |
| | | pratos Trocos | 253 | | |
| | | pratos diversos | 110-111 | | |
| | | pratos Óbidos | 102 | | |
| | | pratos pasta/risotto | 111 | | |
| | | pratos pizza | 111-112 | | |
| | | pratos Snack | 107 | | |
| | | pratos Tokio | 103 | | |
| | | pratos Trocos | 253 | | |
| | | pratos diversos | 110-111 | | |
| | | pratos Óbidos | 102 | | |
| | | pratos pasta/risotto | 111 | | |
| | | pratos pizza | 111-112 | | |
| | | pratos Snack | 107 | | |
| | | pratos Tokio | 103 | | |
| | | pratos Trocos | 253 | | |
| | | pratos diversos | 110-111 | | |
| | | pratos Óbidos | 102 | | |
| | | pratos pasta/risotto | 111 | | |
| | | pratos pizza | 111-112 | | |
| | | pratos Snack | 107 | | |
| | | pratos Tokio | 103 | | |
| | | pratos Trocos | 253 | | |
| | | pratos diversos | 110-111 | | |
| | | pratos Óbidos | 102 | | |
| | | pratos pasta/risotto | 111 | | |
| | | pratos pizza | 111-112 | | |
| | | pratos Snack | 107 | | |
| | | pratos Tokio | 103 | | |
| | | pratos Trocos | 253 | | |
| | | pratos diversos | 110-111 | | |
| | | pratos Óbidos | 102 | | |
| | | pratos pasta/risotto | 111 | | |
| | | pratos pizza | 111-112 | | |
| | | pratos Snack | 107 | | |
| | | pratos Tokio | 103 | | |
| | | pratos Trocos | 253 | | |
| | | pratos diversos | 110-111 | | |
| | | pratos Óbidos | 102 | | |
| | | pratos pasta/risotto | 111 | | |
| | | pratos pizza | 111-112 | | |
| | | pratos Snack | 107 | | |
| | | pratos Tokio | 103 | | |
| | | pratos Trocos | 253 | | |
| | | pratos diversos | 110-111 | | |
| | | pratos Óbidos | 102 | | |
| | | pratos pasta/risotto | 111 | | |
| | | pratos pizza | 111-112 | | |
| | | pratos Snack | 107 | | |
| | | pratos Tokio | 103 | | |
| | | pratos Trocos | 253 | | |
| | | pratos diversos | 110-111 | | |
| | | pratos Óbidos | 102 | | |
| | | pratos pasta/risotto | 111 | | |
| | | pratos pizza | 111-112 | | |
| | | pratos Snack | 107 | | |
| | | pratos Tokio | 103 | | |
| | | pratos Trocos | 253 | | |
| | | pratos diversos | 110-111 | | |
| | | pratos Óbidos | 102 | | |
| | | pratos pasta/risotto | 111 | | |
| | | pratos pizza | 111-112 | | |
| | | pratos Snack | 107 | | |
| | | pratos Tokio | 103 | | |
| | | pratos Trocos | 253 | | |
| | | | | | |



| | |
|-------------------------------|---------------|
| A | |
| aprons | 325 |
| astrays | 201, 280 |
| B | |
| baby seat | 320 |
| bag utensils (cutters) | 66 |
| bamboo tablecloth protector | 220 |
| bar mat | 272 |
| bar spouts | 272-273 |
| barbecue brush/brush | 339 |
| barrier | 255 |
| baskets (tacos) | 56 |
| baskets/ paper basket | 335-336 |
| beer mugs | 140, 171, 271 |
| bell | 274 |
| belt | 255 |
| bill holder | 252 |
| bill spike | 253 |
| bird's nest mould | 56 |
| blenders | 296-297 |
| bone saw | 298 |
| bottle "FLAIR" FBA | 273 |
| bottle collar | 255 |
| bottle stopper | 269 |
| bottles (glass) | 142, 176 |
| bottles with holders | 211 |
| boxes for food | 64 |
| bread basket | 213-218 |
| brushes | 82 |
| bucket (debris) | 64 |
| buckets (food) | 64 |
| buckets cleaning | 333 |
| buffer dish | 184 |
| C | |
| cabinet/refrigerator cabinet | 310-317 |
| cables (cleaning) | 338 |
| cake marker | 85 |
| cake moulds | 89-90 |
| can opener | 78 |
| capsule reservoir | 270 |
| casseroles | 10-17, 24-25 |
| cereal dispenser | 212 |
| chafing dish | 228-230 |
| champagne bowl | 260 |
| change plates | 112 |
| cheese slicer | 70 |
| chef jacket | 324 |
| chocolate fountain | 307 |
| choppers/scrapers | 83 |
| cleaning cars | 332-333 |
| climatisation cabinet | 310-317 |
| cocktail mixers | 286 |
| cocktail spoon | 265-266 |
| cocktail strainers | 264-265 |
| coffee dispenser | 225 |
| coffee grounds box | 272 |
| coffee pot | 277-278 |
| colanders | 56-57 |
| colanders (steam cooker) | 56 |
| colour identification (racks) | 345 |
| condiments holder | 267 |
| cone support | 179 |
| confectioner's hat | 325 |
| contact grills | 301 |
| containers GN (melamine) | 201-202 |
| containers GN (PC) | 240-241 |
| containers GN (PP) | 242 |
| containers GN (st. steel) | 235-239 |
| containers GN lids | 238-239 |
| convection oven | 305 |

| | |
|-----------------------------------|----------------------|
| cookie press | 94 |
| cooler bottle | 223 |
| cooling plate | 231 |
| core remover | 67 |
| corkscrew | 269 |
| cream whipper | 93 |
| crumbs cleaner | 253 |
| cups stand | 272 |
| cups/glasses | 154-172 |
| cups/saucers glass | 142 |
| cut pasta | 74 |
| cut potatoes machine | 72-74 |
| cutlery dispenser | 51 |
| cutlery rack | 344 |
| cutlery/cutlery (appetizers) | 150-152, 220 |
| cutters - fruits/vegetables | 66 |
| cutting boards/support | 77-78 |
| D | |
| decanter | 176 |
| decorating bottles | 59 |
| decorative placards | 255 |
| dessert bowls | 143-146 |
| disposable (apron) | 551 |
| disposable (cutlery) | 545 |
| disposable (glasses) | 540-542 |
| disposable (gloves) | 552-553 |
| disposable (mask) | 551 |
| disposable (package) | 543-544 |
| disposable (toothpick/skewers) | 547-548 |
| dough cutters | 75, 84, 91-93 |
| drain box | 521 |
| drink mixer | 295 |
| drink revolver server | 272 |
| dry fruits dispenser | 212 |
| dumpling mould | 60 |
| E | |
| easy-glide fonfont smoothen | 83 |
| egg slicer | 73 |
| eggs holder | 186 |
| eggs separator | 81 |
| electric bain-marie | 231, 309, 318 |
| electric crepe maker | 306 |
| electric fryers | 303-305 |
| electric heating for chafing dish | 232 |
| electric mixer (pub) | 265 |
| electric soup kettle | 230-231 |
| electric squeezers | 294 |
| electric thermos | 248-249 |
| electric toasters | 302-303 |
| exhibitors | 87-211 |
| exhibitors (glass) | 211 |
| F | |
| finger food | 226 |
| fish scraper | 76 |
| floor lamps | 321 |
| floor washer/accessories | 340 |
| folding canvas cart | 332 |
| fondue | 181 |
| food dehydrator | 306 |
| food pan for chafing dish | 229 |
| forks | 39, 42-44 |
| fruit bowls | 203 |
| frying pan | 11, 13, 15-16, 29-30 |
| frying pan (cast iron) | 26-27 |
| fuel gel | 232 |
| funnel | 58 |
| G | |
| garlic press | 60 |
| gas lighter with flame | 62 |
| gel lamps | 232 |

| | |
|-------------------------------|-------------|
| glass bottles | 142, 176 |
| glass cleaner | 339 |
| glass mugs | 141-142 |
| glass rimmer | 267 |
| gloves (oven) | 36 |
| graters | 69-71 |
| gravy boat | 185 |
| gravy spoon holder | 219, 232 |
| green bean cutter | 73 |
| grill tongs | 47-48 |
| grills | 31 |
| H | |
| hamburguers maker | 60 |
| hammers | 60 |
| heat shade | 233 |
| hooks | 52, 181 |
| hot cupboards | 310-317 |
| HOT DOG bread machine | 301 |
| HOT DOG grills | 301 |
| I | |
| ice bucket/ice bucket stand | 258-261 |
| ice cream scoop | 97 |
| ice crusher | 262 |
| ice cubes maker | 299 |
| ice mill | 262 |
| ice shovel | 262 |
| ice tongs | 261 |
| individual plate mat/stand | 187 |
| induction adapter | 18 |
| information plate (wet floor) | 333 |
| J | |
| jigger | 272 |
| jugs (acrylic) | 222-223 |
| jugs (glass) | 174-176 |
| jugs (porcelaine) | 140 |
| jugs (pub) | 271 |
| juice dispenser | 224 |
| K | |
| kneaders | 296 |
| knives | 75 |
| L | |
| ladles | 39-44 |
| ladles acrylic (buffet) | 225 |
| liquid dispenser | 223-224 |
| lunch box | 181 |
| M | |
| mace mojito | 266 |
| magnet support for knives | 76 |
| mandolines | 72 |
| manual squeezers | 61, 266 |
| marking dishes | 112 |
| mazagran | 140 |
| measuring jugs | 54, 80 |
| measuring pastry | 81 |
| meat mincers | 73, 297-298 |
| melamines | 193-202 |
| menu holder | 253 |
| menu stand | 253 |
| menus (slate) | 254-255 |
| milk dispenser | 224 |
| milk jug | 278 |
| mixers | 296-297 |
| mop | 338 |
| mortar and pestle | 60-61 |
| moskito killer | 320 |
| mould for laminating cakes | 84 |
| moulds (bonbons) | 93 |
| moulds (eggs) | 54 |
| moulds (hamburger) | 60 |
| muffins moulds | 125 |



| | | | | | |
|------------------------------|--------------|---------------------------------|----------------|------------------------|------------------|
| mugs with lid | 142 | ravioli maker | 74 | straw dispenser | 275 |
| N | | recharge mop | 338 | straw holder | 275 |
| napkin holder | 275 | refrigerator counter | 310-317 | sugar bowls | 228-229 |
| natural slate | 192 | reserved signal | 252 | support (milk package) | 278 |
| nozzles/ pastry bags/support | 94-96 | roasters | 33-35 | support/hooks bottle | 270 |
| nut cracker | 78 | rolling pin | 83 | swedish saw | 84 |
| O | | round dish for paella | 11, 29 | syringe (sauces) | 59 |
| oil can | 185 | rubber map | 348 | T | |
| order bars | 52 | rubbish basket | 355-356 | table numbers | 252 |
| organizer | 274-275 | S | | tablecloths pegs | 253 |
| outdoor gas heater | 321 | salad bowls (glass) | 147 | tasting spoons | 130 |
| oven tray tongs | 36 | salad bowls (PC/AS) | 147 | tea bag plate | 140 |
| oyster opener | 76 | salad bowls (porcelaine) | 120 | tea boxes | 279 |
| P | | salad bowls (st. steel) | 55 | tea filter | 278 |
| pan with lamp | 230-231 | salad spinner | 57 | tea infusion | 278 |
| pans/baskets serving | 179 | salad/cake tongs | 46-47, 218-219 | teapots | 138-139, 276-277 |
| pants | 325 | salt/pepper | 182-184 | termotrans | 246 |
| paper dispenser | 346 | saucepan | 11, 13, 18, 80 | thermal pot | 247 |
| paper plates | 288 | saucers dispenser | 87 | thermometers | 62 |
| pastina machine slicer | 74 | sausage machine | 74 | thermos | 249 |
| pastry funnel | 80-81 | scales | 62 | timmer | 62 |
| pastry gas torch/recharge | 87 | scarves | 325 | finned skimmers | 39 |
| pedal bin | 355-356 | scissors | 76 | toilet signal | 348 |
| peelers | 67-68, 298 | scraper for glass-ceramic | 339 | tomato cutter | 73 |
| pepper/salt mill | 183 | scrapers | 50 | trolley for containers | 243 |
| pizza base | 37 | seafood forks | 178 | trolley for racks | 345 |
| pizza box | 75 | self-service trays | 243 | trolley for trays | 243 |
| pizza cutter | 75 | service trolley | 244-245 | W | |
| pizza oven | 306 | serving cups | 178-179 | waffle cones maker | 309 |
| pizza oven scoop | 37 | serving tongs | 46-47, 218-219 | waffle maker | 306 |
| plate covers | 186, 209-217 | serving trays | 205 | wall ashtrays | 336 |
| plates - cakes | 148 | set utensils (dough) | 93 | warming plate | 231 |
| plates - Coupe Hotel | 105 | sets steak on the stone | 182 | waste containers | 334-335 |
| plates - Filados | 108 | shakers | 263-264 | whisks | 81-82 |
| plates - Hotel (relief) | 109 | shapes (paper) | 287 | wine cooler | 225 |
| plates - Hotel N | 104 | sharpening | 76 | wine drop stop ring | 269 |
| plates - Lagos | 106 | shelves/table shelves | 316 | wine vacuum sealer | 269 |
| plates - Öbidos | 102 | shoe shine machine | 340 | woks | 11, 17, 24 |
| plates - pasta/risotto | 111 | shoes | 327 | wood/bamboo (buffet) | 220 |
| plates - pizza | 111-112 | shovels (kitchen/pastry) | 54 | | |
| plates - Snack | 107 | sieves | 81 | | |
| plates - steak | 111 | signals (hot tea, coffee, milk) | 250 | | |
| plates - Tokio | 103 | silicone covering | 86 | | |
| plates - various | 110-111 | sink | 317 | | |
| plates - st. steel | 181 | skewers | 180-181 | | |
| plates (cast iron) | 27 | skimmers | 39-44 | | |
| plates with lid | 207-208 | sliced sausage / vegetables | 298 | | |
| porcelain (appetizers) | 126-129 | soap dispenser | 347 | | |
| porcelain (boards) | 192 | soundproofing box | 295 | | |
| porcelain (bowls) | 120-124 | soup container | 231 | | |
| porcelain (casseroles) | 114 | spaghetti server | 41, 43-44 | | |
| porcelain (containers) | 203 | spatulas (kitchen) | 49-50 | | |
| porcelain (cup/saucer) | 131-137 | spatulas (pastry) | 82 | | |
| porcelain (frypan) | 114-115 | splitting guide | 239 | | |
| porcelain (mugs) | 140 | spoon | 40-45, 219 | | |
| porcelain (pie tray) | 115 | spoon for honey | 178 | | |
| porcelain (roasters) | 115 | st. steel bols | 54-55 | | |
| porcelain (sushi trays) | 118 | st. steel grates | 86 | | |
| porcelain (tart tray) | 117 | st. steel grills | 85-86 | | |
| porcelain (trays) | 116-119 | st. steel pastry frames | 93 | | |
| potato mashing machine | 59-60 | st. steel soup tureen | 204 | | |
| potatoes press | 59-60 | st. steel trays | 205 | | |
| powder shaker | 88 | stand for individual wipe | 187 | | |
| precision fongs | 46 | stand for trays | 37 | | |
| pressure cookers/accessories | 20-22 | sticks for por cakes | 287 | | |
| price holder | 252 | stock pots | 10, 13-15, 18 | | |
| punch bowl | 225 | stone clean grills | 339 | | |
| R | | stove /stove for food | 312 | | |
| racks | 342-344 | strainers (kitchen) | 57-58 | | |
| ramekin | 125 | strainers (tea) | 278 | | |



| | |
|------------------------------------|---------------|
| A | |
| abre ostras | 76 |
| abrelatas | 78 |
| accesorio para ravioli | 74 |
| aceiteras | 184-185 |
| adaptador induccion | 18 |
| agifadores coctél | 286 |
| alcuza | 185 |
| alfombra de goma | 348 |
| alfombra de silicona | 86 |
| alfombra escurridora bar | 272 |
| alisador pasta azúcar | 83 |
| amasadoras | 296 |
| anilla anti-goteo | 269 |
| armarios | 310-317 |
| armarios calentadores | 310-317 |
| armarios frigoríficos | 310-317 |
| armarios refrigeradores | 310-317 |
| aros inoxidable | 93 |
| asador grill | 31 |
| aserrador de huesos | 298 |
| asiento infantil | 320 |
| azucareros | 227-228 |
| B | |
| bandejas de camarero | 274 |
| bandejas servir | 205 |
| baño maria | 231, 309, 318 |
| barra sujeción notas | 52 |
| básculas | 62 |
| base rejilla para pizza | 37 |
| batedor eléctrico (bar) | 265 |
| batidoras | 296-297 |
| batidores | 81-82 |
| bivaque de confitería | 325 |
| blondas de papel | 287 |
| bolsa utensilios (cortadores) | 66 |
| bomba manual vacío | 269 |
| boquillas/manga repostería/soporte | 94-96 |
| botella "FLAIR" FBA | 273 |
| botella enfriadora | 223 |
| botellas (vidrio) | 142, 176 |
| botellas bar | 273 |
| botellas biberón | 59 |
| botellas con soportes | 211 |
| botellas vidrio (cocina) | 114 |
| bufandas | 325 |
| C | |
| cables (limpieza) | 338 |
| cacerolas | 10-17, 24-25 |
| cacillos | 39-44 |
| cacillos acrílicos | 225 |
| cafeteras | 277-278 |
| cafeteras termos | 249-250 |
| caixa para pizza | 37 |
| caja alimentos | 63, 181 |
| caja de drenaje | 272 |
| caja insonorización acústico | 295 |
| caja para té | 279 |
| cajas/cubetas para alimentos | 63, 181 |
| calentador de platos | 313 |
| calentador terraza | 321 |
| calzado | 327 |
| campanilla | 274 |
| carro lona | 332 |
| carros (cestas limpieza) | 345 |
| carros (cubetas GN) | 243 |
| carros (portabandejas) | 243 |
| carros de limpieza | 332-333 |
| carros servicio | 244-245 |
| carteles decorativos | 255 |

| | |
|----------------------------------|----------------|
| cascanueces | 78 |
| cazo | 11, 13, 18, 80 |
| cedazos | 81 |
| cenicero mural | 336 |
| ceniceros | 280-281 |
| centrifugadora | 57 |
| cepillo de barba | 339 |
| cestas (cubiertos) | 334 |
| cestas (tacos) | 56 |
| cestas (vapor) | 56 |
| cestas de pan | 231-218 |
| cestas para vajilla | 342-344 |
| chafing dish | 228-230 |
| chaira | 76 |
| champanero | 260 |
| chaquetas de jefe | 324 |
| coctelera | 263-264 |
| coladores (cocina) | 57-58 |
| coladores (coctél) | 264-265 |
| coladores (thé) | 278 |
| contenedor de combustible | 232 |
| contenedor sopa | 231 |
| contenedores cubiertos | 51 |
| copas/vases | 154-172 |
| cordón | 255 |
| corta judías verdes | 73 |
| corta tomate | 73 |
| cortador de patatas fritas | 72-74 |
| cortadores frutas | 66 |
| cortahuevos | 73 |
| cortamasas | 75, 84, 91-93 |
| cortapastas (repostería) | 84 |
| cortapizza | 75 |
| crêpera | 306 |
| cubetas GN (inox) | 235-239 |
| cubetas GN (melamina) | 201-202 |
| cubetas GN (PC) | 240-241 |
| cubetas GN (PP) | 242 |
| cubiertos/cubiertos (aperitivos) | 150-152, 220 |
| cubos (alimentos) | 64 |
| cubos (debris) | 64 |
| cubos de basura | 334-335 |
| cubos de hielo/pie porta-cubos | 258-261 |
| cubos de limpieza | 333 |
| cubreplatos | 186, 209-217 |
| cuchara de miel | 178 |
| cucharas de degustación | 130 |
| cucharas de servir | 40-45, 219 |
| cucharas medidoras | 81 |
| cucharillas cocktail | 264-265 |
| cuchillo para pizza | 75 |
| cuchillos | 75 |
| D | |
| decanter | 176 |
| delantales | 325 |
| depósito para corchos | 270 |
| descápsulador | 269-270 |
| descorazonadores | 67 |
| desechable (cubiertos) | 286 |
| desechable (delantales) | 289 |
| desechable (embalaje) | 285-286 |
| desechable (guantes) | 289 |
| desechable (máscaras) | 289 |
| desechable (palitons/pinchos) | 287 |
| desechable (vasos) | 284-285 |
| desescamador de pescado | 76 |
| deshidratador de alimentos | 306 |
| dispensador de frutas secas | 212 |
| dispensador de pajitas | 275 |
| dispensadores de café | 225 |

| | |
|--|---------|
| dispensadores de cereales | 212 |
| dispensadores de jabón | 347 |
| dispensadores de leche | 224 |
| dispensadores de líquidos | 223-224 |
| dispensadores de salsas | 87 |
| dispensadores de zumo | 224 |
| dispensadores toallas | 346-347 |
| doseadores respotería | 87 |
| dosificadores bar | 273 |
| dosificadores licor | 272 |
| E | |
| embudo | 58 |
| embudo respotería | 80-81 |
| encendedor de gas | 62 |
| encimera refrigeradora | 310-317 |
| enfriabotellas | 225 |
| ensaladeras inox | 55 |
| ensaladeras PC/AS | 147 |
| ensaladeras porcelana | 120 |
| ensaladeras vidrio | 147 |
| escoba | 339 |
| escurrideras | 56-57 |
| espátula recogedor | 253 |
| espátulas cocina | 49-50 |
| espátulas respotería | 82 |
| especieros | 88 |
| esprimidores eléctricos | 294 |
| esprimidores manuais | 61, 266 |
| espumadera (alambre) | 39 |
| espumaderas | 39-44 |
| estantes/estantes para mesa | 316 |
| estrado | 248 |
| estufa para comida | 312 |
| expositor para mantel individual | 187 |
| expositores | 87, 211 |
| expositores de vidrio | 211 |
| F | |
| fiambra | 181 |
| filtro de té | 278 |
| finger food | 226 |
| fondos perforados | 239 |
| fondue | 181 |
| freidoras | 303-305 |
| fruteros | 203 |
| fuelle de chocolate | 307 |
| fuelle para chafing dish | 229 |
| G | |
| ganchos | 52, 181 |
| gel combustible | 232 |
| glass rimmer | 267 |
| gofrera | 306 |
| granero de café molido | 272 |
| guantes (horno) | 36 |
| guía divisora | 239 |
| H | |
| horno de conveccion | 305 |
| hornos pizza | 306 |
| I | |
| indicador de precios | 252 |
| indicador RESERVADO | 252 |
| indicadores (cestas vajillas) | 345 |
| indicadores (té caliente, café, leche) | 250 |
| indicadores wc | 348 |
| infusor de té | 278 |
| J | |
| jarras (bar) | 271 |
| jarras acrílicas | 222-223 |
| jarras medidoras | 54, 80 |
| jarras porcelana | 140 |
| jarras vidrio | 174-176 |

| | | | | | |
|----------------------------------|---------------|-------------------------------------|----------------|---------------------------------|----------------------|
| jarros con tapa | 142 | passapurés | 59 | raspador de queso | 70 |
| jarros de cerveza | 140, 171, 271 | peladores | 67-68, 298 | raspadores | 50 |
| jarros de vidrio | 141-142 | picadoras de carne | 73, 297-298 | raspadores vitrocerámica | 339 |
| jeringa (salsas) | 59 | picadoras de hielo | 262 | rasquetas | 83 |
| juego carne a la piedra | 182 | piedra para limpiar parrillas | 339 | rebanador de embutidos/verduras | 298 |
| juego utensilios (massa) | 93 | pinceles | 82 | recarga fregona | 338 |
| juegos vinagreras-aceíferas | 184 | pincho a la orden | 253 | rodillos | 83 |
| L | | pinchos | 180-181 | rodos | 338-339 |
| laminador de hielo | 298 | pinchos para mariscos | 178 | rustideras | 33-35 |
| lámparas de calentamiento | 233 | pinza sujeta manteles | 253 | S | |
| lámparas de jardín | 321 | pinzas de hielo | 261 | sacacorchos | 269 |
| lava platos | 317 | pinzas emplatar | 46 | salero/pimentero | 182-184 |
| lecheras | 278 | pinzas grill | 47-48 | salsera chafing dish | 219, 232 |
| libradores (cocina) | 54 | pinzas para horno y bandejas | 36 | salseras | 185 |
| libradores (hielo) | 262 | pinzas servicio mesa | 46-47, 218-219 | salvamanteles en bambú | 220 |
| licuadoras | 294-295 | pistola repostería | 94 | sarténs | 11, 13, 15-16, 29-30 |
| limpia vidrios | 339 | pizarra natural | 192 | sarténs hierro fundido | 26-27 |
| M | | pizzarras menú | 254-255 | sarténs/cestillos | 179 |
| madera/bambú (buffet) | 220 | placa de información (suelo mojado) | 333 | separador de claras | 81 |
| mandolinas | 72 | placas calentamiento | 231 | servidores espaguetis | 41, 43, 44 |
| mantas enfriadoras | 225 | placas eléctricas | 232 | servilletero | 275 |
| manteles individuales | 187 | placas enfriadora | 231 | sierra sueca | 84 |
| mantequera | 184 | planchas grill | 301 | sifón crema | 93 |
| máq. lavadora de piso/accesorios | 340 | planchas HOT DOG | 301 | soperas inox | 204 |
| máquina de hamburguesas | 74 | platillo de cambio | 253 | soplete/recarga gas | 87 |
| máquina de hielo | 299 | plato para bolsa de té | 140 | soporte (envase leche) | 278 |
| máquina hacer conos | 309 | platos (hierro fundido) | 27 | soporte de conos | 179 |
| máquina hacer embutidos | 74 | platos (steak) | 111 | soporte de copas | 272 |
| máquina laminadora pasta | 74 | platos con tapa | 207-208 | soporte giratorio | 272 |
| máquina lustradora de zapatos | 340 | platos Coupe Hotel | 105 | soporte magnético cuchillos | 76 |
| máquina para pan HOT DOG | 301 | platos de presentación | 112 | soporte para rustideras | 37 |
| marcador de tartas | 85 | platos Filados | 108 | soporte/ganchos para botellas | 270 |
| martillos | 60 | platos Hotel (relieve) | 109 | soportes menú | 252 |
| mata mosquitos | 320 | platos Hotel N | 104 | soportes para pinchos | 180 |
| maza mojito | 266 | platos inoxidable | 181 | T | |
| mazagran | 140 | platos Lagos | 106 | tablas de corte/soportes | 77-78 |
| melaminas | 193-202 | platos Obidos | 102 | tapas para cubetas GN | 238-239 |
| mezclador de bebidas | 295 | platos para pasteles | 148 | tapón champán | 269 |
| mezcladores de cocktail | 286 | platos pasta/risotto | 111 | fazas de postre | 143-146 |
| molde para laminar pasteles | 84 | platos pizza | 111-112 | fazas/ensaladeras inox | 54-55 |
| molde para pizza | 37 | platos Snack | 107 | fazas/platillos vidrio | 142 |
| moldes (bombones) | 93 | platos Tokio | 103 | temporizador | 62 |
| moldes (empanadillas) | 60 | platos varios | 110-111 | tenedores | 39, 42-44 |
| moldes (hamburguesa) | 60 | ponchera | 225 | termómetros | 62 |
| moldes (huevos) | 54 | porcelana (asaderas) | 115 | termos | 249 |
| moldes (papel) | 287 | porcelana (bandejas sushi) | 118 | termos eléctricos | 248-249 |
| moldes (pasteles) | 89-90 | porcelana (bols) | 120-124 | termotrans | 246 |
| moldes muffins | 125 | porcelana (cacerolas) | 114 | teteras | 138-139, 276-277 |
| molinillos pimienta/salero | 182-184 | porcelana (cubetas) | 203 | tijeras | 76 |
| mopas | 338 | porcelana (fuentes) | 116-119 | tostadoras | 302-303 |
| morteros con mano | 60-61 | porcelana (plato gratinados) | 114-115 | V | |
| N | | porcelana (porta aperitivos) | 126-129 | vasos de servir | 178-179 |
| nidos de alambre | 56 | porcelana (tablas) | 192 | vertedores | 272-273 |
| números de mesa | 252 | porcelana (tartera) | 115 | vitriñas | 209-210, 217 |
| O | | porcelana (fazas) | 140 | W | |
| ollas | 10, 13-15, 18 | porcelana (fazas/platillo) | 131-137 | woks | 11, 17, 24 |
| ollas (lámpara) | 231 | porcelana (fortera) | 115 | | |
| ollas de presión/accesorios | 20-22 | porta cubiertos | 51 | | |
| ollas sopa (eléctricas) | 230-331 | porta facturas | 252 | | |
| ollas termo | 247 | porta huevos | 186 | | |
| organizador | 274-275 | porta menús | 252 | | |
| P | | porta pajitas | 275 | | |
| paelleras | 11, 29 | poste separación | 255 | | |
| pala patatas fritas | 56 | pots | 278 | | |
| palas/pala pizza | 37 | prensa ajos | 60 | | |
| palillos (pop cakes) | 287 | prensa patatas | 59-60 | | |
| pantalones | 325 | R | | | |
| papeleras | 335-336 | racionador helado | 97 | | |
| parrillas inoxidable | 35 | ralladores | 69-71 | | |
| parrillas repostería | 86 | ramequin | 125 | | |



| | |
|-----------------------------|---------------|
| A | |
| accessoire pour raviolis | 74 |
| adaptateur induction | 18 |
| agitateurs cocktail | 286 |
| allume-gaz à flamme | 62 |
| anneau stop gouttes | 269 |
| appareil anti-moustiques | 320 |
| armoire chauffante cuisine | 310-317 |
| armoires/armoire réfrigérée | 310-317 |
| assiettes Filados | 108 |
| assiettes Hotel (relief) | 109 |
| assiettes Hotel N | 104 |
| assiettes inoxydable | 181 |
| assiettes Lagos | 106 |
| assiettes Obidos | 102 |
| assiettes pasta/risotto | 111 |
| assiettes pizza | 111-112 |
| assiettes Snack | 107 |
| assiettes Tokio | 103 |
| assiettes (fer fondu) | 27 |
| assiettes avec couvercle | 207-208 |
| assiettes Coupe Hotel | 105 |
| assiettes divers | 110-111 |
| assiettes pour gâteaux | 148 |
| assiettes présentation | 112 |
| assiettes steak | 111 |
| B | |
| bac pour soup | 231 |
| bacs GN (inox) | 235-239 |
| bacs GN (melamina) | 201-202 |
| bacs GN (PC) | 240-241 |
| bacs GN (PP) | 242 |
| bain-marie | 231, 309, 318 |
| balances | 62 |
| barre à notes | 52 |
| base pour pizza | 37 |
| baçons | 287 |
| batteur électrique (bar) | 265 |
| batteurs | 296-297 |
| beurrer avec couvercle | 184 |
| bivague pâtisserie | 325 |
| bois/bambou (buffet) | 220 |
| boîte à condiments | 267 |
| boîte alimentaire | 63 |
| boîte d'insonorisation | 295 |
| boîte de vidange | 272 |
| boîte frappez | 272 |
| boîtes distributeur de thé | 279 |
| boîtes/cuves nourriture | 63, 181 |
| bol à punch | 225 |
| bols à dessert | 143-146 |
| bols mixeurs | 294-295 |
| bols/saladiers inox | 54-55 |
| bouchon de champagne | 269 |
| bouteille réfrigérant | 223 |
| bouteille "FLAIR" FBA | 273 |
| bouteilles biberon | 59 |
| bouteilles de bar | 273 |
| bouteilles verre | 142, 176 |
| brochette de commander | 253 |
| brochettes | 180-181 |
| brosse barbecue/brosse | 339 |
| broyeur à glace | 262 |
| C | |
| câbles de nettoyage | 338 |
| cafetières | 277-278 |
| cafetières thermos | 249-250 |
| casiers à vaisselle | 342-344 |
| casse noix | 78 |
| chandrier mural | 336 |

| | |
|-----------------------------------|---------------|
| chandriers | 280-281 |
| cercles inox | 93 |
| chafing dish | 228-230 |
| chalumeau de cuisine | 87 |
| chariot en toile X | 332 |
| chariot pour casiers | 345 |
| chariots (plateaux) | 243 |
| chariots de nettoyage | 332-333 |
| chariots de service | 244-245 |
| chariots pour bacs GN | 243 |
| chauffage de terrasse | 321 |
| chauffe-assiettes | 313 |
| chaussure | 327 |
| chope à bière | 140, 171, 271 |
| ciseaux | 76 |
| cloches | 186, 209-217 |
| cocottes à pression/accessoires | 20-22 |
| cocottes avec lampe | 230 |
| comptoirs réfrigérée | 310-317 |
| corbeille à pain | 213-218 |
| cordons | 255 |
| corp de chauffe | 232 |
| coupe capsule | 269-270 |
| coupe pate | 83 |
| coupe-frites | 72-74 |
| coupe-légumes/viande | 298 |
| coupe-oeuf | 73 |
| couteau à huîtres | 76 |
| couteau à pizza | 75 |
| couteau pour fruits | 66 |
| couteaux de cuisine | 75 |
| couvercle por bacs GN | 238-239 |
| couverts/couverts (apéritifs) | 150-152, 220 |
| cremiere | 278 |
| crêpière | 306 |
| crochets | 52, 181 |
| cuillère à doser | 81 |
| cuillères | 40-45, 219 |
| cuillères à glace | 97 |
| cuillères à spaghetti | 41, 43-44 |
| cuillères cocktail | 265-266 |
| cuillères dégustation | 130 |
| cuillère pour miel | 178 |
| cuisinière | 305 |
| cuit-pâtes | 56 |
| curettes à homard | 178 |
| D | |
| decanter | 176 |
| decoupoirs | 91-93 |
| dénoyauteur | 67 |
| dépôt pour capsules | 270 |
| deshydrateur | 306 |
| dessous de plats bambou | 220 |
| dispensateur de jus | 224 |
| dispensateurs d'essuie | 275 |
| dispensateurs de café | 225 |
| dispensateurs de céréales | 212 |
| dispensateurs de lait | 224 |
| dispensateurs de liquide | 223-224 |
| dispensateurs sauces | 87 |
| dispensateurs à savon | 347 |
| distributeur de pailles | 275 |
| distributeur de serviettes | 275 |
| distributeur fruits secs | 212 |
| doseurs (pâtisserie) | 87 |
| douilles/poche à décorer/supporte | 94-96 |
| E | |
| écumoirs | 39-44 |
| écumoirs (etamee) | 39 |
| électrique marmite | 230-231 |

| | |
|---------------------------------------|--------------|
| emballage à pizza | 37 |
| ensemble steak dans la pierre | 182 |
| entonnoir | 58 |
| entonnoir pâtisserie | 80-81 |
| éplucheuses | 67-68, 298 |
| éponge | 339 |
| essoreuse à salade | 57 |
| estrade | 248 |
| étagères/étagères de table | 316 |
| exposant pour nappe individuel | 187 |
| F | |
| faitouts | 10-17, 24-25 |
| filtre pour le thé | 278 |
| finger food | 226 |
| flacons avec support | 211 |
| flacons verre | 148 |
| fonds perforée | 239 |
| fondue | 181 |
| fontaine à chocolat | 307 |
| fouets | 81-82 |
| foulards | 325 |
| four à air pulse | 305 |
| fourchettes | 39, 42-44 |
| fours pizza | 306 |
| frappés | 225 |
| friteuses | 303-305 |
| fusil à affûter | 76 |
| G | |
| gants de cuisine | 36 |
| gaufrier | 306 |
| gel de chauffe | 232 |
| glass rimmer | 267 |
| grattoir de poissons | 76 |
| grattoir pour vitrocéramique | 339 |
| gril | 31 |
| grille-pain | 302-303 |
| grilles de contact | 301 |
| grilles HOT DOG | 301 |
| grilles inox | 35 |
| grilles pâtisserie | 86 |
| guide de division | 239 |
| H | |
| hachoir haricots verts | 73 |
| hachoir tomate | 73 |
| hachoirs | 73, 297-298 |
| huile et vinaigrie | 184-185 |
| huilier | 185 |
| I | |
| identificateurs (paniers à vaisselle) | 345 |
| indicateur réservée | 252 |
| infuseur à thé | 278 |
| J | |
| jetable (couverts) | 286 |
| jetable (cure-dents/brochettes) | 287 |
| jetable (emballage) | 285-286 |
| jetable (gants) | 289 |
| jetable (masques) | 289 |
| jetable (tabliers) | 209 |
| jetable (verres) | 284-286 |
| L | |
| laminoir pour le fromage | 70 |
| lampe chauffante | 233 |
| lampe jardin | 321 |
| laver la vaisselle | 317 |
| laveur de vitres | 339 |
| lisseur fondant | 83 |
| louches | 39-44 |
| louches acryliques | 225 |
| M | |
| machine à glace | 299 |



FR

index alphabétique

| | | | | | |
|---------------------------------|----------------|----------------------------------|----------------------|-----------------------------------|------------------|
| machine à laver planches/acces. | 340 | plaque chauffante | 231 | seau (débris) | 64 |
| machine à polir chussures | 340 | plaque informative (sol mouillé) | 333 | seau (nourriture) | 64 |
| machine faire cônes | 309 | plaque list de prix | 252 | seau nettoyage | 333 |
| machine faire hamburguers | 74 | plaque réfrigérant | 231 | seaux à glace/porte-seau | 258-261 |
| machine lamineuse à pâte | 74 | plaques (thé chaud, café, lait) | 250 | séparateur à oeuf | 81 |
| machine pain HOT DOG | 301 | plaques électrique | 232 | set huilier et vinaigries | 184 |
| machine pour saucisses | 74 | plat à paella | 11, 29 | shakers | 263-264 |
| mandolines | 72 | plat à rotir | 33-35 | siège de bébé | 320 |
| marmites | 10, 13-15, 18 | plat petit pour changement | 253 | signalétique lieux publics | 348 |
| marmites ferme | 247 | plat pour bain marie | 229 | siphon à crème | 93 |
| marqueur à gateaux | 85 | plat pour sachet de thé | 140 | sonnette de réception | 274 |
| mardeaux | 60 | plateau ardoise | 191 | soupières inox | 204 |
| mazagran | 140 | plateau de service | 205 | spatules (cuisine) | 49-50 |
| melamines | 193-202 | plateaux antidérapant | 274 | spatules (pâtisserie) | 82 |
| mélangeur de boisson | 295 | plateaux inox | 274 | sucriers | 227-228 |
| mélangeurs à cocktail | 286 | poche pour utensiles | 66 | support (emballage lait) | 278 |
| ménus ardoise | 254-255 | pochons | 11, 13, 18, 80 | support à coupes | 272 |
| mesure à cocktail | 272 | poêles | 11, 13, 15-16, 29-30 | support coupes | 179 |
| mil de glace | 262 | poêles fer fondu | 26-27 | support magnetique pour couteaux | 76 |
| minuteur | 62 | poêles/paniers à servir | 179 | support pour plateaux | 37 |
| mortiers avec pilon | 60-61 | pompe à vide pour bouteille | 269 | support rotatif | 272 |
| moule à pizza | 37 | porcelaine (bacs) | 203 | supports brochettes | 180 |
| moules (bonbons) | 93 | porcelaine (bols) | 120-124 | supports menus | 252 |
| moules (hamburger) | 60 | porcelaine (cocottes) | 114 | supports/crochets pour bouteilles | 270 |
| moules à chaussons | 60 | porcelaine (planches) | 192-193 | T | |
| moules à œufs | 54 | porcelaine (plat à four) | 115 | tabliers | 325 |
| moules muffins | 125 | porcelaine (plat à gratin) | 114-115 | famis | 81 |
| moules papier | 89, 90 | porcelaine (plat à tarte) | 115 | tapis caoutchouc /sisal | 348 |
| moules tartes | 89, 90 | porcel. (présentation) | 116-119 | tapis égouttoir pour verres | 272 |
| moulin à poivre/salière | 183 | porcelaine (plateau sushi) | 118 | tapis silicone | 86 |
| N | | porcelaine (porte-apéritifs) | 126-129 | tasses avec couvercle | 142 |
| napérons papier | 288 | porcelaine (tasses) | 140 | tasses et gobelets | 154-172 |
| nappe individuel/exposant | 187 | porcelaine (tasses/soucoupes) | 131-137 | tasses pour servir | 178-179 |
| numéros de table | 252 | porcelaine (fourrière) | 117 | tasses verre | 141-142 |
| O | | porte-addition | 252 | tasses/soucoupes verre | 142 |
| organisateur | 274-275 | porte-bruleur | 232 | termotrans | 246 |
| ouvre-boîte | 78 | porte-couverts | 51 | théières | 138-139, 276-277 |
| P | | porte-menus | 253 | thermomètre | 62 |
| panier à nid | 56 | porte-oeufs | 186 | thermos | 249 |
| paniers à fruits | 203 | porte-pailles | 275 | tire-bouchon | 269 |
| paniers (facos) | 56 | pot mesureur | 54, 80 | U | |
| paniers à couverts | 344 | poteau | 255 | ustensiles pâtisserie | 93 |
| pantalon | 325 | poubelles | 334-335 | V | |
| passoire à cocktail | 264-265 | présentoirs buffet | 87-211 | verseurs pour bouteille | 272-273 |
| passoire à thé | 278 | présentoirs verre | 211 | vestes au chef | 324 |
| passoires cuisine | 57-58 | presse ail coupe | 60 | vitrines | 209-210, 217 |
| pelle à farine | 54 | presse-fruits électrique | 294 | W | |
| pelle à glace | 262 | presse-fruits manueles | 61, 226 | woks | 11, 17, 24 |
| pelle frit | 56 | presse-pomme de terre | 59-60 | | |
| pelles /pelle pizza | 37 | presse-purée | 59 | | |
| pelle ramasse-miettes | 253 | R | | | |
| pétrisseur | 296-297 | raclettes (nettoyage) | 338-339 | | |
| pichets acryliques | 222-223 | rafraichisseur à bouteilles | 225 | | |
| pichets bar | 271 | ramequin | 125 | | |
| pichets porcelaine | 140 | râpes | 50 | | |
| pichets verre | 174-176 | recharge balai | 338 | | |
| pièce nettoyer les grilles | 339 | rafraichisseur à champagne | 260 | | |
| pilon mojito | 266 | rouleau pâtisier | 83 | | |
| pince à glace | 261 | roulette pizza | 75 | | |
| pince à nappe | 253 | S | | | |
| pince pour bac | 36 | saladiers inox | 55 | | |
| pinces | 82 | saladiers PC/AS | 147 | | |
| pinces (précision) | 46 | saladiers porcelaine | 120 | | |
| pinces à grill | 47-48 | saladiers verre | 147 | | |
| pinces à salade/gateaux | 46-47, 218-219 | salière/poivre | 182-184 | | |
| pinces à servir | 46-47, 218-219 | saucière chafing-dish | 219-232 | | |
| pistolet (sauces) | 59 | saucieres | 185 | | |
| pistolet pâtisserie | 94 | saupoudreuses | 88 | | |
| placards décoratifs | 255 | scie à gateaux | 84 | | |
| planche à découper | 77-78 | scie de os | 298 | | |

NOTAS

notes notas notes

A series of horizontal dotted lines for writing notes.

A series of horizontal dotted lines for writing.



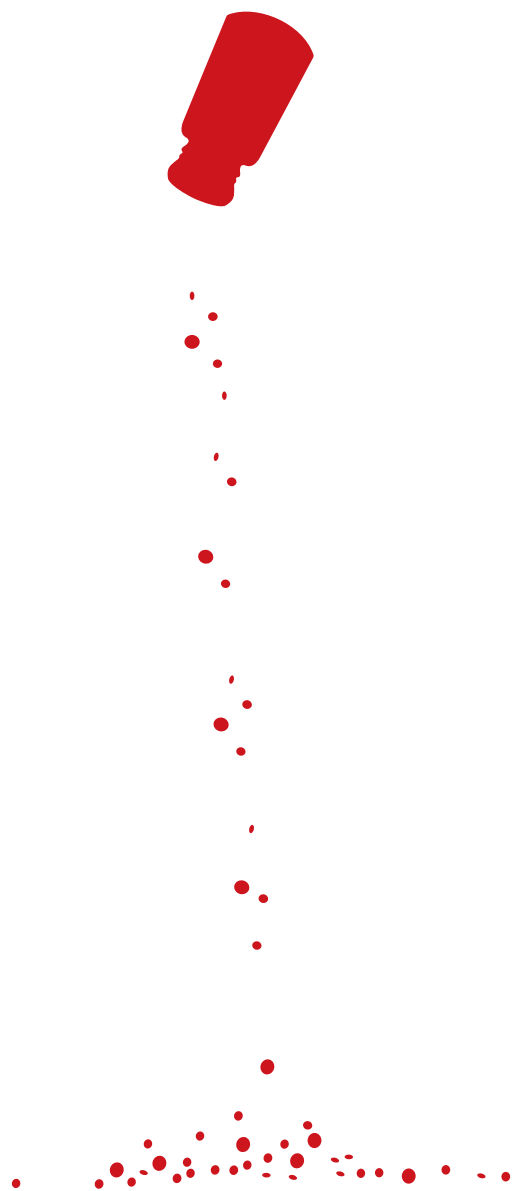

www.lizotel.pt
SINCE 2002



SHOWROOM
LIZOTEL PROFESSIONAL
Estrada Nacional Nr. 8, Nr. 82
2500 - 294 Caldas da Rainha
PORTUGAL

Tel.: +351 262 870 290
Telm.: +351 961 221 039

www.lizotel.pt
geral@lizotel.pt