



buffet | tabletop | bar

GASTRONOMIE- UND SERVIERARTIKEL

FOOD SERVICE EQUIPMENT
EQUIPAMIENTOS PROFESIONALES
EQUIPEMENT PROFESSIONNEL



2023

SINCE 1933

90
years

run by family

APS – Werkstatt und Bühne für den Genuss

APS – Workshop and
stage for enjoyment



family-run company
since 1933

managing director Reinhold Pott | Bastian Becker



- Eigene Produktion in Deutschland
- 25.000 Euro-Palettenlagerplätze
- own production in Germany
- 25,000 Euro pallet storage spaces



buffet | tabletop | bar

Assheuer + Pott GmbH & Co. KG
Talweg 11 | 59846 Sundern
Germany

Phone: +49 (0) 2933 / 97 35 - 0
E-Mail: info@aps-germany.de
aps-germany.de



Keep in touch! [aps_germany](https://www.aps-germany.de)



Visit our website!



Ihr Mehrwert: Inspiration & Service

- ✓ aktuellste Nonfood-Trends im Sortiment
- ✓ hohe Warenverfügbarkeit

Your added value: Inspiration & Service

- ✓ latest nonfood-trends in the range
- ✓ high availability of goods

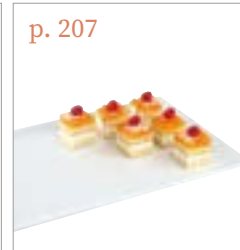

Buffet & Display

Buffet & Tableware
Melamin

Tableware &
Table Presentation

Baskets

Chafing Dish,
GN Container & Transport

Bar, Café & Drinkware

Kitchen & Servingtools

Covers & Accessories

APS – KNOW-HOW

We only work with the raw material manufacturer who has the best technology in the industry.



MELAMINE

- ✓ 100% pure melamine
- ✓ BPA free, urea free
- ✓ perfect for serving dishes
- ✓ extremely break and shock resistant
- ✓ sustainable due to durability and robustness
- ✓ hygienic surfaces
- ✓ environmentally friendly due to low processing temperature
- ✓ 100% dishwasher safe
- ✓ useable up to max. 70°C

STAINLESS STEEL

Chrome-nickel steel is used in a wide variety of products due to its attractive appearance, as a brightly polished, ground or brushed variant.

- ✓ hygienic surface
- ✓ durable and easy to clean
- ✓ recyclable
- ✓ good temperature conductor
- ✓ 100% dishwasher safe

PLASTIC PP - PS - SAN - TRITAN

- ✓ crystal clear
- ✓ BPA free
- ✓ hygienic surface
- ✓ high resistance to heat
- ✓ easy to clean
- ✓ durable, no disposable plastic
- ✓ recyclable



WOOD

acacia-beech-oak-olive



PORCELAIN



Präzisionsarbeit und Design für Ihren Erfolg

Precision work and design for your success

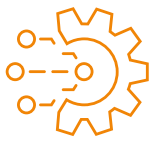

state-of-the-art
manufacturing
technology



eco-friendly



high
professional
usability

QUALITÄT

- ✓ Jedes Produkt muss mehr als zwei Qualitätskontrollen bestehen.
- ✓ Wir verwenden nur 100% reines Material.
- ✓ Jedes Rohmaterial wird streng geprüft.

QUALITY

- ✓ Each product must pass more than two quality checks.
- ✓ We only use 100% pure material.
- ✓ Each raw material is strictly tested.

DESIGN

- ✓ Unsere eigenständig entwickelten Produkte verfügen über zahlreiche Design-Patente im In- und Ausland.
- ✓ Wir entwickeln Produktlösungen für jeden individuellen Kundenbedarf.

DESIGN

- ✓ Our independently developed products have rich / multi design patents at home and abroad.
- ✓ We develop product solutions for every individual customer need.



APS production | Made in Germany



Design team

DEUTSCH

Artikel Seite

A

| | |
|------------------------|---|
| Abräumwagen | 360, 364-365 |
| Abtropfmatte | 409 |
| Adapter / Zwischensteg | 354, 356 |
| Allzweckgießer | 368-369, 416 |
| Antirutschmatte | 36, 383 |
| Aschenbecher | 427-430 |
| Aufstrichmesser | 461 |
| Auslagenplatte | 135, 289, 311 |
| Ausgießer | 50-51, 260-263, 265-266, 369, 400, 411-412, 470 |
| Ausstellblech | 251, 469 |
| Austernmesser | 458 |

B

| | |
|------------------------|---|
| Backblech | 111, 251, 360 |
| Backform | 469, 478-479 |
| Backhandschuhe | 478 |
| Baguette Korb | 92, 310, 316 |
| Bain-Marie | 335-336, 338-340, 343-346, 348, 466 |
| Bar-Caddy | 409 |
| Barlöffel | 399 |
| Barmaß | 397, 398 |
| Barmatte | 409 |
| Barsieb | 400, 464 |
| Becher | 39-40, 123, 218, 240, 270, 280, 305, 385, 387-396, 427-432, 434, 467-468, 497 |
| Becher Emaille | 280 |
| Behälter | 294-296, 312, 368, 401 |
| Bento Box | 156-157 |
| Beschriftungsetiketten | 304 |
| Beschriftungskarten | 298-301 |
| Besteckablage | 218, 351 |
| Besteckbehälter | 21, 137-138, 295, 312, 366-367 |
| Besteckkorb | 294, 317 |
| Besteckständer | 294 |
| Bestecktaschen | 277 |
| Beton | 141, 168, 260, 272, 274-275, 298, 381, 384 |

| | |
|-------------------------------|---|
| Bierglasträger | 131, 423 |
| Blattschale Melamin | 176, 217, 490 |
| Bonleiste | 473 |
| Bonspieß | 473 |
| Brennpastenbehälter Edelstahl | 350 |
| Brezel- oder Wurstständer | 84 |
| Brotstation | 88 |
| Brotkorb | 88, 93, 318-319, 326-327 |
| Brot Schneidebrett | 59, 88, 130 |
| Brötchenschütze | 215 |
| Brötchenspender Edelstahl | 93 |
| Brottasche | 320-322 |
| Buffet Box | 70 |
| Buffet Kühlset | 18, 112 |
| Buffet-Set | 93 |
| Buffetbrett | 52, 117-118, 129 |
| Buffetgestell | 93 |
| Buffetkorb | 16, 93, 314-315, 319 |
| Buffetleiter | 77, 78, 80-81, 93 |
| Buffetschilder | 20, 45, 304, 495 |
| Buffetständer | 61, 66, 69, 74-75, 91, 96-98, 118, 157, 184, 217, 287 |
| Buffetständer Edelstahl | 98 |
| Buffetständer Holz | 61, 66, 74-75, 98 |
| Buffetständer Metall | 69, 96-97, 118, 157, 184, 287 |
| Buffetvitrine | 25-28, 34 |
| Buffetvitrine Edelstahl | 25-26, 28, 34 |
| Butterdose | 270 |
| Butterservierer | 270 |
| Bürste Bar | 412 |

C

| | |
|-------|----------------------------------|
| Caddy | 126, 141, 246, 272-273, 296, 409 |
|-------|----------------------------------|

| | |
|----------------------------|-----------|
| Cerealienspender | 21, 59-62 |
| Cerealienspender Edelstahl | 21, 59-62 |
| Chafing Dish | 334-346 |
| Chafing Dish Rolltop | 348 |
| Champagnerkühler | 376-378 |
| Cocktailmesser | 401 |

D

| | |
|--------------------------|---|
| Darioform | 469 |
| Deckel | 65, 77, 209-210, 214, 225, 286, 355-358, 480, 493-495 |
| Deckel Edelstahl | 355-356 |
| Dekoriermesser | 401, 458 |
| Dip-Schälchen | 196, 202, 213, 221, 223, 229, 237-239 |
| Dispenser Saft | 20, 41, 43-45 |
| Dispenser Milch | 20, 44-46 |
| Dosier- & Vorratsflasche | 411, 475-476 |
| Dosierer Zucker | 267-268, 417-418 |
| Dosierpumpe | 477 |
| Dosierspender | 477 |
| Dressingtopf Edelstahl | 73 |
| Dressingtopf Melamin | 73 |
| Dressingtopf Porzellan | 73 |

E

| | |
|-------------------|-----------------------------|
| Eier-Box | 368, 477 |
| Eierbecher | 218, 270 |
| Eierkorb | 311 |
| Eierschneider | 462 |
| Eimer | 369 |
| Eis-Kugel-Former | 404 |
| Eisbox | 405 |
| Eiseimer | 373, 405-406 |
| Eisportionierer | 474 |
| Eisschaufel | 406 |
| Eiswaffel-Ständer | 474 |
| Eiswasserröhre | 36, 52-53, 383 |
| Eiswürfelform | 404 |
| Eiszange | 407 |
| Eiszerkleinerer | 406 |
| Emaille-Artikel | 211, 270, 279-280, 287 |
| Entkerner | 457 |
| Etagère | 67-68, 82-87, 116, 186, 216 |

F

| | |
|--------------------------|--|
| Fadenschneider | 456 |
| Fast-Food Tablett | 133 |
| Feuerzangenbowle-Set | 271, 347 |
| Fingerfood-Löffel | 200, 219-220 |
| Flambierbrenner | 474 |
| Flasche | 52-53, 266, 281, 411, 413, 433, 475-476 |
| Flaschenhalter Wein | 382 |
| Flaschenkühler | 54, 56, 228, 372, 375-376, 379-382, 388, 410 |
| Flaschenöffner | 56, 413 |
| Folien-Abreißvorrichtung | 473 |
| Fondue-Set | 271, 347 |
| Frischhaltedeckel | 19, 286 |

G

| | |
|-----------------------|---|
| Gabel Fleisch | 439, 442-443 |
| Gabel Salat | 438, 441, 454 |
| Spitzsieb | 464 |
| Gebäckpalette | 459 |
| Gebäckzange | 446-447, 450-451 |
| Gemüsehobel | 466 |
| Getränkspender | 36-40, 383-384 |
| Getränkewanne | 55, 377 |
| Gewürzständer | 265 |
| Gewürzstreuer | 258 |
| Gläsernschiene | 392 |
| Glasumrander | 409 |
| Glocke | 292, 426 |
| Gourmetlöffel | 240, 453 |
| GN Abtropfgitter | 356, 358 |
| GN Behälter | 100, 224-225, 353-354, 357-359, 361-363 |
| GN Behälter Edelstahl | 100, 353-354 |

| | |
|----------------------------|---------------------------|
| GN Besteckbehälter | 137-138, 312, 360, 367 |
| GN Buffetgestell | 316 |
| GN Buffetleiter | 80-81 |
| GN Buffetständer | 157 |
| GN Buffetvitrine Edelstahl | 25-26, 28 |
| GN Chafing Dish | 335-336, 338-339, 343-346 |

| | |
|-----------|------------------------------------|
| GN Deckel | 225, 355-358, 362 |
| GN Haube | 17, 99-100, 316, 318, 348, 484-487 |

| | |
|------------------------|-----------------------|
| GN Korb | 16, 309, 312-314, 324 |
| GN Korb Metall | 324 |
| GN Korb Polypropylen | 16, 309, 312-314 |
| GN Naturschieferplatte | 24, 250 |
| GN Partyplatte | 108 |
| GN Rost | 360 |
| GN Schale Melamin | 153-154, 182, 224-225 |
| GN Servierbrett | 424 |
| GN Serviergestell | 17 |

| | |
|------------|--|
| GN Tablett | 153, 156, 159, 161, 166, 169-170, 173, 183, 185, 188, 193, 202, 204, 206-207 |
|------------|--|

| | |
|----------------------|--|
| GN Tablett Edelstahl | 15, 29, 99-101, 204 |
| GN Tablett Melamin | 24, 66, 153, 156, 159, 161, 166, 169-170, 173, 183, 185, 188, 193, 202, 204, 206-207 |
| GN Tablett Porzellan | 15, 360 |
| GN Wanne | 15, 24 |

| | |
|---------------|-----|
| Gourmetgläser | 285 |
|---------------|-----|

H

| | |
|-------------------------|---|
| Häkelkorb | 322 |
| Haube | 14, 16-17, 94, 99-102, 104-107, 122, 136, 166, 170, 180, 217, 290, 316, 318, 348, 484-497 |
| Haube Rolltop | 16-17, 25-30, 102, 112, 129, 217, 315, 348, 487 |
| Haube Rolltop Edelstahl | 348 |
| Haubenhalterung | 94 |
| Heizelement | 47, 348-350 |
| Hobel | 84, 458, 466 |
| Holzbox | 128, 246, 272-273 |
| Honiglöffel | 455 |
| Hummerbrecher | 462 |
| Hygieneschutz | 84, 90, 93 |

I

| | |
|----------------------|--------------------------------|
| Induktionskochplatte | 76, 334, 336-338, 340-341, 349 |
| Iso-Dispenser | 41 |
| Isolierkanne | 47-49 |

K

| | |
|---------------------------|--|
| Kaffeebecher | 280, 305, 432 |
| Kaffeedispenser Edelstahl | 47, 348 |
| Kaffeekanne | 415 |
| Kanne | 45-50, 52-53, 57, 235, 269, 414-416, 419 |
| Kanne Saft | 50, 52-53 |
| Karaffe Glas | 50-53 |
| Kartenhalter | 297-302 |
| Käsehobel | 458 |
| Kaviarkühler | 106, 271 |
| Kellnermesser | 413 |
| Kerzenleuchter | 274 |
| Kreide-Marker | 304 |
| Konditorplatte | 216 |
| Konferenzkühler | 410 |
| Korb Edelstahl | 234, 326-327 |
| Korb Metall | 234, 323-325, 327-328 |
| Korb Polypropylen | 294, 308-319 |
| Korkenzieher | 413 |
| Kronkorkenschale | 56 |
| Kugelausstecher | 456 |
| Kühlakku | 27-34, 42, 496 |
| Kühlbox | 18, 28-30, 54, 112 |
| Kühlkaraffe | 50 |
| Kühlmanschette | 382 |
| Kühlschale | 19, 31-33 |

| | |
|-------------|------------|
| Kühltablett | 14, 27, 29 |
|-------------|------------|

L

| | |
|----------------------------|---|
| Likör- und Fondanttrichter | 466 |
| Limettenpresse | 403, 472 |
| Löffel | 218-220, 240, 399, 438-445, 453, 455, 465 |
| Löffel Backen | 465 |
| Löffel Feinkost | 453 |
| Löffel Fingerfood | 2000, 219-220 |
| Löffel Frittieren | 465 |
| Löffel Gourmet | 240, 253 |
| Löffel Salat | 218, 438, 441, 454 |
| Löffel Saucen, Dressing | 441, 453, 481 |
| Löffel Spaghetti | 440 |
| Lunchbag | 322, 434 |
| Lunchbox | 329, 435 |

M

| | |
|---------------------------------------|---|
| Magnet-Messerhalter | 473 |
| Mandoline | 466 |
| Mehrwegbecher | 305, 432, 497 |
| Menage | 256, 259-266 |
| Messbecher | 467-468 |
| Messlöffelsatz | 451 |
| Metallrahmen für Induktionskochplatte | 336-338, 349 |
| Milchdispenser | 20, 44 |
| Milchgießer/-kännchen | 235, 269 |
| Milchkanne | 45-46, 235, 269, 414-416 |
| Minis | 212, 220-221, 232-233, 235, 257, 269, 394, 416, |

| | |
|--------------------|---------|
| Moscow Mule Becher | 388-390 |
|--------------------|---------|

| | |
|---------------|--------------|
| Mühle Pfeffer | 252-257, 266 |
|---------------|--------------|

| | |
|------------|--------------|
| Mühle Salz | 252-257, 266 |
|------------|--------------|

| | |
|----------------------|----|
| Multi Rack Edelstahl | 95 |
|----------------------|----|

| | |
|----------|----|
| Multibox | 58 |
|----------|----|

| | |
|-------------|-----|
| Muscheltopf | 287 |
|-------------|-----|

| | |
|--------------|-----------|
| Müslispender | 21, 59-61 |
|--------------|-----------|

N

| | |
|---------------------|--|
| Naturschieferplatte | 24, 87, 112-116, 120-121, 249-250, 256 |
|---------------------|--|

P

| | |
|------------------------|---------------|
| Palmbattschale Melamin | 176, 190, 214 |
| Panierstation | 472 |
| Parmesan Menage | 264-265 |
| Partyplatte | 108 |
| Passiersieb | 463-464 |
| Pendelschäler | 457 |
| Permanent-Ausgießer | 412 |
| Pfanne | 102, 231-233 |
| Pfannenwender | 439, 444 |
| Pfeffermühle | 252-257, 266 |
| Pinsel | 272, 281 |
| Pinzettzange | 407, 452 |
| Pitcher | 54, 380 |
| Pizzaform | 478-480 |
| Pizzaschaufel | 479 |
| Pizzaschneider | 457, 462, 480 |
| Platzsets | 276-278 |
| Platzteller | 292 |
| Pommes-Frites-Seiher | 465 |
| Porzellan | 46, 338, 340 |
| Pump-Isolierkanne | 47 |

Q

| | |
|----------------|---------|
| Quetschflasche | 475-476 |
|----------------|---------|

R

| | |
|------------------|--------------|
| Rechnungstablett | 293, 426 |
| Regalwagen | 365 |
| Reinigungsbürste | 412 |
| Rezeptionsglocke | 426 |
| Rolltop-Set | 30, 106, 115 |
| Rührbecher | 468 |
| Rührglas | 411 |

S

| | |
|---------------|---------------|
| Saftdispenser | 20, 41, 43-45 |
| Saftkanne | 50, 52-53 |
| Salatbesteck | 438, 454 |

| | | | |
|-----------------------------------|--|---|---|
| Salatzange | 445-449 | Stößel | 402 |
| Salat-Löffel | 441 | Stövchen | 58 |
| Salzmühle | 252-257, 266 | Streichpalette | 459 |
| Sauciere | 291-292 | Streuer | 257-258, 465 |
| Schälchenspender | 79 | Streuer Pfeffer | 257, 465 |
| Schale Aluminium | 237, 323 | Streuer Salz | 257-258, 465 |
| Schale Beton | 74 | Superbox | 21-24, 330-331 |
| Schale Edelstahl | 19, 102, 229, 232, 235-237, 327 | Suppenkelle | 441, 443, 445 |
| Schale Emaille | 279-280, 287 | Suppentopf | 337, 345-346 |
| Schale Glas | 77, 106 | Sushiboard Holz | 124, 247 |
| Schale Holz | 69, 119, 127-128, 241-242, 495 | Sushiboard Melamin | 147-148, 198 |
| Schale Melamin | 145-154, 156, 160, 162-165, 167-169, 172, 174, 176, 179, 181-186, 190-191, 194-199, 201-223, 493 | T | |
| Schaufel Eis | 406 | Tablet Caddy | 126, 128, 141, 246, 272-273 |
| Schaufel Mehl | 470, 481 | Tablett 14-15, 24, 27, 29, 35, 72, 83, 88, 94, 99-106, 109-111, 124-125, 131-133, 144, 146-148, 153, 156, 159-161, 163, 166, 169-174, 179, 183, 185-189, 192-194, 198, 200, 202, 204, 206-207, 210, 215, 217, 360, 423, 426 | |
| Schaumlöffel | 440, 445 | Tablett Edelstahl | 14-15, 34-35, 99-106, 109-111, 228, 251, 293, 420-422, 426 |
| Schaumspeisering | 468 | Tablett Fast Food | 133, 425 |
| Schiefer | 24, 28, 87, 112-116, 120-121, 244, 249-250, 256 | Tablett Holz | 83, 88, 94, 107, 124-125, 132, 243, 246-247, 424 |
| Schilder | 297-299, 304, 495 | Tablett Melamin | 83, 88, 144, 146-148, 153, 156, 159-161, 163, 166, 169-174, 179, 183, 185-189, 192-194, 198, 200, 202, 204, 206-207, 210, 215, 217, 363 |
| Schlüsselschnur | 410 | Teebox | 58 |
| Schneebesen | 462 | Teebrühsieb | 418 |
| Schneidbrettständer | 474 | Teekanne ASIA | 57, 419 |
| Schneidebrett | 15, 88-89, 130, 401 | Teigbehälter | 368, 480 |
| Schöpflöffel | 438, 440, 442-443, 445 | Teigschaber / Abstecher | 461, 480 |
| Schutzmantel | 48 | Teller Emaille | 279 |
| Sektkühler | 55, 372-375, 377-378 | Teller Fingerfood | 204 |
| Senftöpfchen | 261 | Teller Melamin | 144, 146-148, 160, 162, 164, 175, 192, 194, 198, 204, 208, 217, 222 |
| Servierbox | 187 | Thermometer | 415 |
| Serviertöpfchen | 106, 232-233 | Thermo Tablett-Set | 35 |
| Servier- / Tortenplatte Edelstahl | 105, 135, 289 | Thermo-Set | 30 |
| Servier- / Tortenplatte Holz | 122, 134-135, 288-289 | Tischrestehbehälter | 295-296 |
| Servier- / Tortenplatte Melamin | 134, 216, 288 | Tischaufsteller | 300, 304 |
| Servierbrett | 83, 119-126, 128-129, 242-249 | Tischkartenhalter | 297-302 |
| Servierfrittierkorb | 114, 234 | Tischkrümelentferner | 292, 426 |
| Serviergabel | 438-439, 442-443, 453 | Tischsets | 276-278 |
| Serviergestell | 79, 84-86, 286 | Tortenheber | 439, 441 |
| Servierkelle | 230, 441 | Tortenmesser | 439 |
| Servierkorb | 234, 237 | Tortenplatte | 105, 115, 122, 134-135, 216, 288-289 |
| Servierlöffel | 218, 438, 440-443, 445 | Tortenring | 469 |
| Servierpfanne | 102, 232-233 | To-Go Becher | 305, 432, 497 |
| Servierpfanne Gusseisen | 231 | Transportwagen | 364-365 |
| Servierset | 150-151 | Tretbeutelhalter | 431 |
| Serviertablett | 109-111, 125, 131-132, 246, 251, 421-424 | Trichter | 369, 466, 471 |
| Servierwagen | 364-365 | Trinkbecher | 39-40, 385, 387 |
| Servierzange | 446 | Trinkflasche | 433 |
| Serviettenhalter | 139-141 | Trinkglas | 38, 386 |
| Serviettenringe | 293 | Trinkhalme | 408 |
| Serviettentaschen | 277 | Tropfenschale Melamin | 37, 39, 384 |
| Shaker | 395-396 | U | |
| Sieb | 400-401, 418, 463-464 | Universalbox | 65 |
| Snackbox | 126-127, 230, 243 | Universalkanne | 414-415 |
| Snackholder | 232-239 | Untersetzer Edelstahl | 293 |
| Snackpresenter | 92 | Untersetzer Kork | 40 |
| Snackspender | 240, 393 | Untersetzer Naturschiefer | 114, 250, 256 |
| Spachtel | 461 | V | |
| Spaghettizange | 445, 449 | Vase | 275 |
| Spargelzange | 486 | Verschluss Wein / Champagner | 412 |
| Sparschäler | 456 | Vorspeisenzange | 449 |
| Speisenwärmer | 350 | Vorratsglas | 63-64 |
| Spießständer / Spieße | 271 | W | |
| Spritzflasche | 266, 411 | Wachspapier | 111, 114, 126, 236, 251, 420 |
| Standascher | 430 | Wanne | 15, 368 |
| Ständer | 61, 66, 69, 74-75, 84, 96-98, 157, 179-180, 184, 216-217, 271, 287, 328, 474 | Warenträger | 108, 276 |
| Ständer Wein- / Sektkühler | 374 | Wärme-Kies | 351 |
| Staubkappen | 410 | | |
| Stielkasserolle | 233 | | |
| Stift | 304 | | |

| | |
|-------------------|---------------------------|
| Warnschild | 477, 496 |
| Wasserbadschüssel | 466 |
| Wasserkanne | 50, 52-53 |
| Wasserspender | 36-40, 383-384 |
| Weck Gläser | 65, 282-286 |
| Weinkühler | 55, 372-375, 377-378, 382 |
| Weinkühlerständer | 374 |
| Wender | 439-440, 443-444, 459-460 |
| Windaschenbecher | 427-429 |
| Windlicht | 274 |

| | |
|-------------------------|------------------|
| Z | |
| Zange | 407, 445-452 |
| Ziseliermesser | 456 |
| Zitronenschnitzelpresse | 418 |
| Zitruspresse | 403, 472 |
| Zuckerdosierer | 267-268, 417-418 |
| Zuckerkuigel | 267, 417 |
| Zuckerspender | 267-268, 417-418 |
| Zutatenbehälter | 401 |



ENGLISH

| | |
|------------------------|--|
| item | page |
| A | |
| adapter | 354, 356 |
| air pot | 47 |
| airtight cover | 19, 286 |
| ashtray | 427-430 |
| asparagus tongs | 486 |
| B | |
| baguette basket | 92, 310, 316 |
| Bain-Marie | 335-336, 338-340, 343-346, 348, 466 |
| baking mittens | 478 |
| baking pan | 469, 478-479 |
| baking sheet | 111, 251, 360 |
| bar caddy | 409 |
| bar knife | 401 |
| bar spoon | 399 |
| bar strainer | 400, 464 |
| barrel mug | 39-40, 123, 218, 240, 270, 280, 305, 385, 387-396, 427-432, 434, 467-468, 497 |
| basket metal | 234, 323-325, 327-328 |
| basket polypropylene | 294, 308-319 |
| basket stainless steel | 234, 326-327 |
| beaker | 280 |
| beer rack | 131, 423 |
| Bento Box | 156-157 |
| beverage dispenser | 36-40, 383-384 |
| beverage tub | 55, 377 |
| bill presenter | 293, 426 |
| bill rail | 473 |
| bill spike | 473 |
| bottle | 52-53, 266, 281, 411, 413, 433, 475-476 |
| bottle cooler | 54, 56, 228, 372, 375-376, 379-382, 388, 410 |
| bottle fuel | 350 |
| bottle opener | 56, 413 |
| bowl aluminium | 237, 323 |
| bowl concrete | 74 |
| bowl enamel | 279-280, 287 |
| bowl glass | 77, 106 |
| bowl holder | 79 |
| bowl melamine | 145-154, 156, 160, 162-165, 167-169, 172, 174, 176, 179, 181-186, 190-191, 194-199, 201-223, 493 |
| bowl stainless steel | 19, 102, 229, 232, 235-237, 327 |
| bowl wood | 69, 119, 127-128, 241-242, 495 |
| bread basket | 320-322 |
| bread station | 88 |
| Breadbox | 88, 93, 318-319, 326-327 |
| breeding set | 472 |
| brush | 272, 281 |

| | |
|----------------------------------|---|
| bucket | 369 |
| buffet basket | 16, 93, 314-315, 319 |
| buffet box | 70 |
| buffet ladder | 77, 78, 80-81, 93 |
| buffet set | 93 |
| buffet signs | 20, 45, 304, 495 |
| buffet stand | 61, 66, 69, 74-75, 91, 93, 96-98, 118, 157, 184, 217, 287 |
| buffet stand metal | 69, 96-97, 118, 157, 184, 287 |
| buffet stand stainless steel | 98 |
| buffet stand wood | 61, 66, 74-75, 98 |
| Buffett-board | 52, 117-118, 129 |
| butter dish | 270 |
| butter dish | 270 |
| C | |
| caddy | 126, 141, 246, 272-273, 296, 409 |
| cake lifter | 439, 441 |
| cake plate melamine | 134, 216, 288 |
| cake plate stainless steel | 105, 135, 289 |
| cake plate wood | 122, 134-135, 288-289 |
| cake setting ring | 469 |
| cake slice | 439 |
| cake stand | 105, 115, 122, 134-135, 216, 288-289 |
| candle holder | 274 |
| cap bowl | 56 |
| cast iron pan | 231 |
| caviar cooler | 106, 271 |
| cereal dispenser | 21, 59-62 |
| cereal dispenser stainless steel | 21, 59-62 |
| Chafing Dish | 334-346 |
| Chafing Dish Rolltop | 348 |
| chalk marker | 304 |
| champagne bowl | 55, 372-375, 376-378 |
| cheese dish | 264-265 |
| cheese slicer | 458 |
| chefs blow torch | 474 |
| chopping board | 15, 88-89, 130, 401 |
| cleaning brush | 412 |
| clingfilm tear-off dispenser | 473 |
| cloche / dome cover | 292, 426 |
| coaster cork | 40 |
| coaster natural slate | 114, 250, 256 |
| coaster stainless steel | 293 |
| coffee cup | 280, 305, 432 |
| coffee dispenser stainless steel | 47, 348 |
| coffee pot | 415 |
| concrete | 141, 168, 260, 272, 274-275, 298, 381, 384 |
| confectionery funnel | 466 |
| conference bottle cooler | 410 |
| conical strainer | 464 |
| container | 294-296, 312, 368, 401 |
| cool collar | 382 |
| cooler | 27-34, 42, 496 |
| cooling bowl | 19, 31-33 |
| cooling box | 18, 28-30, 54, 112 |
| cooling carafe | 50 |
| cooling plates | 14, 27, 29 |
| corer | 457 |
| corkscrew | 413 |
| cornet stand | 474 |
| cover | 14, 16-17, 65, 77, 94, 99-102, 104-107, 122, 136, 166, 170, 180, 209-210, 214, 217, 225, 286, 290, 316, 318, 348, 355-358, 480, 484-497 |
| cover holder | 94 |
| cover stainless steel | 355-356 |
| crochet rope basket | 322 |
| crumber | 292, 426 |
| curler | 84, 458, 466 |
| cutlery bag | 277 |
| cutlery basket | 294 |
| cutlery dispenser | 294, 317 |

| | | | | | | | |
|-----------------------------------|--|----------------------------|---|---|---|---|---|
| cutlery organizer | 21, 137-138, 295, 312, 366-367 | GN-container | 100, 224-225, 353-354, 357-359, 361-363 | peeler | 456 | spice rack | 265 |
| cutlery rest | 218, 351 | GN-drainer | 356, 358 | pen | 304 | spice shaker | 258 |
| cutting board | 59, 88, 130 | GN-lid | 225, 355-358, 362 | pepper mill | 252-257, 266, 465 | spider spoon | 465 |
| cutting board rack | 474 | gourmet glasses | 285 | pitcher | 45-50, 52-54, 57, 235, 269, 380, 414-416, 419 | spoon | 218-220, 240, 399, 438-445, 453, 455, 465 |
| C | | graduated jug | 467-468 | pizza cutter | 457, 462, 480 | squeeze bottle | 266, 411, 475-476 |
| Dariol moulds | 469 | gravy boat | 291-292 | pizza dish | 478-480 | stainless steel frame for induction plate | 336-338, 349 |
| decorating knife | 401, 458 | H | | pizza peel | 479 | stand for wine / champagne bowl | 374 |
| decorator / zester | 456 | heating unit | 47, 348-350 | placemat | 276-278 | standing ashtray | 430 |
| delicatessen spoon | 453 | honey spoon | 455 | plate enamel | 279 | stirring cup | 468 |
| designation cards | 298-301 | hygienic cover | 84, 90, 93 | plate melamine | 144, 146-148, 160, 162, 164, 175, 192, 194, 198, 204, 208, 217, 222 | strainer | 400-401, 418, 463-464 |
| dip bowl | 196, 202, 213, 221, 223, 229, 237-239 | I | | plate tray | 292 | straws | 408 |
| dispenser | 477 | ice ball former | 404 | plate warmer | 350 | superbox | 21-24, 330-331 |
| dispenser sugar | 267-268, 417-418 | ice box | 405 | porcelain | 46, 338, 340 | sushiboard melamine | 147-148, 198 |
| display plate | 135, 289, 311 | ice bucket | 373, 405-406 | pourer | 368-369, 416 | sushiboard wood | 124, 247 |
| display tray | 251, 469 | ice cream scoop | 474 | pourers 50-51, 260-263, 265-266, 369, 400, 411-412, 470 | | swivel peeler | 457 |
| dosing pump | 477 | ice crusher | 406 | pouring container | 411, 475-476 | T | |
| dough container | 368, 480 | ice cube cooling tube | 36, 52-53, 383 | pretzel-/ sausage stand | 84 | table caddy | 126, 128, 141, 246, 272-273 |
| dough scraper | 461, 480 | ice cube maker | 404 | protective coat | 48 | table garbage bin | 295-296 |
| dressing pot melamine | 73 | ice scoop | 406 | R | | table stands | 297-302, 304 |
| dressing pot porcelain | 73 | ice tong | 407 | refrigerated buffet display | 18, 112 | tea-box | 58 |
| dressing pot stainless steel | 73 | induction plate | 76, 334, 336-338, 340-341, 349 | reusable cup | 305, 432, 497 | teapot ASIA | 57, 419 |
| dressing/sauce spoon | 441, 453, 481 | insulated dispenser | 41 | ring bell | 426 | teapot warmer | 58 |
| drinking bottle | 433 | J | | roll / bun basket | 215 | thermo set | 30 |
| drinking cups | 38-40, 385-387 | jigger | 397, 398 | roll dispenser stainless | 93 | thermo tray | 35 |
| drip mat | 39, 389 | jug | 414-415 | rolltop cover | 16-17, 25-30, 102, 112, 129, 217, 315, 348, 487 | thermometer | 415 |
| drip tray melamine | 37, 39, 404 | juice dispenser | 20, 41, 43-45 | rolltop set | 30, 106, 115 | To-Go cup | 305, 432, 497 |
| dust & fly cap | 410 | juice pitcher | 50, 52-53 | rolltop-cover stainless steel | 348 | tray | 14-15, 24, 27, 29, 35, 67-68, 72, 82-88, 94, 99-106, 109-111, 116, 124-125, 131-133, 144, 146-148, 153, 156, 159-161, 163, 166, 169-174, 179, 183, 185-189, 192-194, 198, 200, 202, 204, 206-207, 210, 215-217, 246, 251, 360, 421-424, 426 |
| E | | K | | S | | tray melamine | 83, 88, 144, 146-148, 153, 156, 159-161, 163, 166, 169-174, 179, 183, 185-189, 192-194, 198, 200, 202, 204, 206-207, 210, 215-217, 246, 251, 360, 421-424, 426 |
| egg basket | 311 | key cord | 410 | salad fork | 438, 441, 454 | tray stainless steel | 14-15, 34-35, 99-106, 109-111, 228, 251, 293, 420-422, 426 |
| egg cutter | 462 | L | | salad spoon | 218, 438, 441, 454 | tray wood | 83, 88, 94, 107, 124-125, 132, 243, 246-247, 424 |
| egg holder | 218, 270 | labeling labels | 304 | salad spoon + fork | 438, 454 | trolley | 365 |
| eggs box | 368, 477 | labels | 297-299, 304, 495 | salad tong | 445-449 | turner | 439, 444 |
| enamel articles | 211, 270, 279-280, 287 | ladle | 438, 440, 442-443, 445 | salt mill | 252-258, 266, 465 | tweezer | 407, 452 |
| F | | leaf melamine | 176, 217, 490 | sandwich knife | 461 | U | |
| fingerfood plate | 204 | lime press | 403, 472 | sauté pan / mini sauce pan | 233 | universal box | 65 |
| fire punch bowl set | 271, 347 | lobster cracker | 462 | scoop | 248, 454-455 | V | |
| flower vase | 275 | lunch bag | 322, 434 | scoop flour | 470, 481 | vacuum jug | 47-49 |
| fondue set | 271, 347 | lunchbox | 329, 435 | scraper | 461 | W | |
| fork | 438-439, 442-443, 453 | M | | service trolley | 364-365 | waiter's corkscrew | 413 |
| free flow pourer | 412 | magnetic knife rack | 473 | serving basket | 234, 237 | whisk | 462 |
| fry baskets | 114, 234 | mandolin | 466 | serving board | 83, 119-126, 128-129, 242-249 | winebottle-stand | 382 |
| fry dripping tray | 465 | mandolin | 466 | serving box | 187 | woodbox | 128, 246, 272-273 |
| funnel | 369, 466, 471 | meatfork | 439, 442-443 | serving cup | 232-239 | | |
| G | | melon baller | 456 | serving set | 150-151 | | |
| glass carafe | 50-53 | menage | 256, 259-266 | serving spoon | 218, 438, 440-443, 445 | | |
| glass rack | 392 | milk dispenser | 20, 44-46, 235, 269, 414-416 | serving stand | 61, 66, 69, 74-75, 79, 84-86, 96-98, 157, 179-180, 184, 216-217, 271, 286-287, 328, 474 | | |
| glass rimmer | 409 | milk jug | 235, 269 | serving tongs | 446 | | |
| GN basket | 16, 309, 312-314, 324 | mini bowl | 212, 220-221, 232-233, 235, 257, 269, 394, 416, 411 | serving trolley | 360, 364-365 | | |
| GN basket metal | 324 | mixing glass | 411 | serving trowel | 230, 441 | | |
| GN basket polypropylene | 16, 309, 312-314 | Moscow Mule barrel mug | 388-390 | set measuring spoon | 451 | | |
| GN bowl melamine | 153-154, 182, 224-225 | mousse ring | 468 | shaker | 257-258, 395-396, 465 | | |
| GN buffet display stainless steel | 25-26, 28 | muddler | 402 | showcase | 25-28, 34 | | |
| GN buffet ladder | 80-81 | multi rack stainless steel | 95 | showcase stainless steel | 25-26, 28, 34 | | |
| GN buffet stand | 157, 316 | multibox | 58 | skewer rack/skewer | 271 | | |
| GN Chafing Dish | 335-336, 338-339, 343-346 | mussel pot | 287 | skimmer | 440, 445 | | |
| GN cover | 17, 99-100, 316, 318, 348, 484-487 | mustard glass | 261 | skimmer spoon | 465 | | |
| GN cutlery organizer | 137-138, 312, 360, 367 | N | | slate | 24, 28, 87, 112-116, 120-121, 244, 249-250, 256 | | |
| GN grid | 360 | napkin bag | 277 | small serving pot | 106, 232-233 | | |
| GN natural slate tray | 24, 250 | napkin holder | 139-141 | snack dispenser | 240, 393 | | |
| GN pan stainless steel | 100, 353-354 | napkin rings | 293 | snack tray | 133, 425 | | |
| GN partytray | 108 | natural slate tray | 24, 87, 112-116, 120-121, 249-250, 256 | snackbox | 126-127, 230, 243 | | |
| GN serving board | 424 | non slip mat | 36, 383 | snackpresenter | 92 | | |
| GN serving stand | 17 | oyster knife | 458 | snap mesh tea ball | 418 | | |
| GN tray | 15, 24, 153, 156, 159, 161, 166, 169-170, 173, 183, 185, 188, 193, 202, 204, 206-207 | P | | soup ladle | 441, 443, 445 | | |
| GN tray melamine | 24, 66, 153, 156, 159, 161, 166, 169-170, 173, 183, 185, 188, 193, 202, 204, 206-207 | palm leaf melamine | 176, 190, 214 | soup pot | 337, 345-346 | | |
| GN tray porcelain | 15, 360 | pan | 102, 231-233 | spaghetti spoon | 440 | | |
| GN tray stainless steel | 15, 29, 99-101, 204 | pan | 102, 232-233 | spaghetti tong | 445, 449 | | |
| | | party spoon | 200, 219-220, 240, 453 | spatula | 459 | | |
| | | partytray | 108 | | | | |
| | | pastry spatula | 459 | | | | |
| | | pastry tongs | 446-447, 450-451 | | | | |
| | | pedal bin | 431 | | | | |

artículos **pág.**

| | |
|--|---|
| A | |
| abridor | 56, 413 |
| adaptador | 354, 356 |
| aro anti-goteo melamina | 37, 39, 384 |
| aro de tarta | 469 |
| aro redondo para semifríos | 468 |
| artículos esmaltados | 211, 270, 279-280, 287 |
| azucarero | 267-268, 417-418 |
| B | |
| bajo plato | 292 |
| bandeja | 14-15, 24, 27, 29, 35, 72, 83, 88, 94, 99-106, 109-111, 124-125, 131-133, 144, 146-148, 153, 156, 159-161, 163, 166, 169-174, 179, 183, 185-189, 192-194, 198, 200, 202, 204, 206-207, 210, 215, 217, 246, 251, 360, 421-423, 426 |
| bandeja acero inoxidable | 14-15, 34-35, 99-106, 109-111, 228, 251, 293, 420-422, 426 |
| bandeja autoservicio y snacks | 133 |
| bandeja autoservicio y snacks | 133, 425 |
| bandeja con alturas | 67-68, 82-87, 116, 186, 216 |
| bandeja de pizarra natural | 24, 87, 112-116, 120-121, 249-250, 256 |
| bandeja isotérmica | 30 |
| bandeja madera | 83, 88, 94, 107, 124-125, 132, 243, 246-247, 424 |
| bandeja para sushi de madera | 124, 247 |
| bandeja para sushi melamina | 147-148, 198 |
| bandeja pastelera | 251, 469 |
| bandeja tartas acero inoxidable | 105, 135, 289 |
| bandeja tartas madera | 122, 134-135, 288-289 |
| bandeja tartas melamina | 134, 216, 288 |
| bandeja termo | 35 |
| bandejas refrigeradas | 14, 27, 29 |
| baño María | 335-336, 338-340, 343-346, 348, 466 |
| barra magnética para cuchillos | 473 |
| barreño botellines | 55, 377 |
| Bento Box | 156-157 |
| bolsa cubiertos | 277 |
| bolsa de almuerzo | 322, 434 |
| bolsa de servilletas | 277 |
| bomba dosificadora | 477 |
| bote | 63-64 |
| bote dosificador flexible | 475-476 |
| bote vertedor universal | 368-369, 416 |
| botella | 52-53, 266, 281, 411, 413, 433, 475-476 |
| botella de combustible líquido | 350 |
| botella exprimible | 266, 411 |
| botes especieros | 258 |
| brocha | 272, 281 |
| C | |
| caballetes buffet | 20, 45, 304, 495 |
| caballetes de mesa | 300, 304 |
| cacerola | 102, 231-233 |
| caddy de mesa | 126, 128, 141, 246, 272-273 |
| cafetera | 415 |
| caja comida | 187 |
| caja de buffet | 70 |
| caja de pan para buffet | 88, 93, 318-319, 326-327 |
| caja dispensadora | 65 |
| caja madera | 128, 246, 272-273 |
| caja para huevos | 368, 477 |
| caja para té | 58 |
| calentador de tetera | 58 |
| campana | 14, 16-17, 94, 99-102, 104-107, 122, 136, 166, 170, 180, 217, 290, 316, 318, 348, 484-497 |
| campana esférica | 292, 426 |
| campana rolltop | 16-17, 25-30, 102, 112, 129, 217, 315, 348, 487 |
| campana rolltop acero inoxidable | 348 |
| candelabro | 274 |
| cantimplora | 433 |
| carro | 365 |
| carro de servicio | 360, 364-365 |
| cazo recto bajo | 233 |
| cenicero | 427-429 |
| cenicero de pie | 430 |
| cepillo de limpieza | 412 |
| cesta acero inoxidable | 234, 326-327 |
| cesta de baguette | 92, 310, 316 |
| cesta de buffet | 16, 93, 314-315, 319 |
| cesta de cuerda de ganchillo | 322 |
| cesta de huevos | 311 |
| cesta metal | 234, 323-325, 327-328 |
| cesta para bollos | 215 |
| cesta para servir | 234, 237 |
| cesta polipropileno | 294, 308-319 |
| Chafing Dish | 334-346 |
| Chafing Dish Rolltop | 348 |
| champañera | 376-378 |
| coctelera | 395-396 |
| colador | 400-401, 418, 463-464 |
| colador cónico | 464 |
| colador de cóctel | 400, 464 |
| conjunto aperitivo | 256, 259-266 |
| corta huevos | 462 |
| corta pasta | 461, 480 |
| cortador de pizza | 457, 462, 480 |
| cubeta | 15, 368 |
| cubierta higiénica antialiento | 84, 90, 93 |
| cubitera | 405 |
| cubitera isotérmica | 373, 405-406 |
| cubitera para cava | 55, 372-375, 377-378 |
| cubitera para vino | 55, 372-375, 377-378, 382 |
| cubo | 369 |
| cuchara | 218-220, 240, 399, 438-445, 453, 455, 465 |
| cuchara de espaguetis | 440 |
| cuchara de miel | 455 |
| cuchara gourmet | 240, 253 |
| cuchara para ensalada | 218, 438, 441, 454 |
| cuchara para helado | 474 |
| cuchara para hornear | 465 |
| cuchara para servir | 218, 438, 440-443, 445 |
| cuchara party | 200, 219-220 |
| cucharilla de cóctel | 399 |
| cucharón | 438, 440, 442-443, 445 |
| cucharón de salsa/aliño | 441, 453, 481 |
| cucharón de sopa | 441, 443, 445 |
| cuchillo acanalador | 401, 458 |
| cuchillo de decoración cincelador | 456 |
| cuchillo para cóctel | 401 |
| cuchillo para untar | 461 |
| cuenco acero inoxidable | 19, 102, 229, 232, 235-237, 327 |
| cuenco aluminio | 237, 323 |
| cuenco de vidrio | 77, 106 |
| cuenco esmaltado | 279-280, 287 |
| cuenco hormigón | 74 |
| cuenco melamina | 145-154, 156, 160, 162-165, 167-169, 172, 174, 176, 179, 181-186, 190-191, 194-199, 201-223, 493 |
| cuenco mini | 212, 220-221, 232-233, 235, 257, 269, 394, 416, |
| cuenco para chapas | 56 |
| cuenco para dip | 196, 202, 213, 221, 223, 229, 237-239 |
| D | |
| descorazonador | 457 |
| dispensador buffet en escalera | 77, 78, 80-81, 93 |
| dispensador de bebidas | 36-40, 383-384 |
| dispensador de bocadillos | 92 |
| dispensador de cereales | 21, 59-62 |
| dispensador de cereales acero inoxidable | 21, 59-62 |
| dispensador de film | 473 |
| dispensador de leche | 20, 44-46, 235, 269, 414-416 |
| dispensador de snacks | 240, 393 |
| dispensador de zumo | 20, 41, 43-45 |
| dispensador en escalera acero inoxidable | 95 |
| dispensador isotérmico | 41 |
| E | |
| embudo | 369, 466, 471 |
| embudo dosificador | 466 |
| enfriador de caviar | 106, 271 |
| enfriador múltiple | 410 |
| escurridor de fritos | 465 |
| espátula | 439-440, 443-444, 459-460 |
| espátula plancha | 461 |
| especiero | 265 |
| espumadera | 440, 445 |
| espumadera para fritos | 465 |
| estación de empanado | 472 |
| estación pan | 88 |
| esterilla antideslizante | 36, 383 |
| esterilla escurridora | 409 |
| etiquetas | 297-299, 304, 495 |
| expositor | 108, 276 |
| expositor buffet | 93 |
| expositor buffet frío | 18, 28-30, 54, 112 |
| expositor de buffet | 61, 66, 69, 74-75, 91, 96-98, 118, 157, 184, 217, 287 |
| expositor de buffet acero inoxidable | 98 |
| expositor de buffet madera | 61, 66, 74-75, 98 |
| expositor de buffet metal | 69, 96-97, 118, 157, 184, 287 |
| expositor para tartas | 135, 289, 311 |
| exprimidor cítricos | 403, 472 |
| F | |
| fiambrera | 329, 435 |
| flaneras | 469 |
| florero | 275 |
| fuelle en forma de hoja de palmera | |
| melamina | 176, 190, 214 |
| fuelle en forma de hoja melamina | 176, 217, 490 |
| fuelle para la mesa | 102, 232-233 |
| funda de frío | 382 |
| funda protectora | 48 |
| G | |
| GN bandeja | 153, 156, 159, 161, 166, 169-170, 173, 183, 185, 188, 193, 202, 204, 206-207 |
| GN bandeja acero inoxidable | 15, 29, 99-101, 204 |
| GN bandeja de pizarra natural | 24, 250 |
| GN bandeja melamina | 24, 66, 153, 156, 159, 161, 166, 169-170, 173, 183, 185, 188, 193, 202, 204, 206-207 |
| GN bandeja party | 108 |
| GN bandeja porcelana | 15, 360 |
| GN campana | 17, 99-100, 316, 318, 348, 484-487 |
| GN cesta | 16, 309, 312-314, 324 |
| GN cesta metal | 324 |
| GN cesta polipropileno | 16, 309, 312-314 |
| GN Chafing Dish | 335-336, 338-339, 343-346 |
| GN cubeta | 15, 24 |
| GN cubeta acero inoxidable | 100, 353-354 |
| GN cuenco melamina | 153-154, 182, 224-225 |
| GN dispensador buffet en escalera | 80-81 |
| GN escurridor | 356, 358 |
| GN expositor buffet acero inoxidable | 25-28 |

| | |
|---|---|
| GN porta cubiertos | 137-138, 312, 360, 367 |
| GN rejilla | 360 |
| GN soporte buffet | 17, 316 |
| GN soporte para buffet | 157 |
| GN tapa | 225, 355-358, 362 |
| granulado térmico | 351 |
| H | |
| hormigón | 141, 168, 260, 272, 274-275, 298, 381, 384 |
| huevo | 218, 270 |
| I | |
| infusor de té, pinza con malla | 418 |
| J | |
| jarra | 45-50, 52-54, 57, 235, 269, 380, 414-416, 419 |
| jarra de agua | 50, 52-53 |
| jarra de leche | 235, 269 |
| jarra de vidrio | 50-53 |
| jarra de zumo | 50, 52-53 |
| jarra enfriadora | 50 |
| jarra graduada | 467-468 |
| jarra termo | 47-49 |
| juego de cucharas medidoras | 451 |
| L | |
| llavero enrollable | 410 |
| M | |
| mandolina | 466 |
| manoplas de panadero | 478 |
| mantelín | 276-278 |
| mantequera | 270 |
| mantequillera | 270 |
| marco de acero inoxidable para placa de inducción | 336-338, 349 |
| marco pastelero | 469, 478-479 |
| marmita | 337, 345-346 |
| medidor jigger | 397, 398 |
| mejillonera | 287 |
| molde de cubitos de hielo esféricos | 404 |
| molde de pizza | 478-480 |
| molde para cubitos de hielo | 404 |
| molinillo de pimienta | 252-258, 266, 465 |
| molinillo de sal | 252-258, 266, 465 |
| mortero | 402 |
| Moscow Mule taza | 388-390 |
| O | |
| organizador de bar | 409 |
| P | |
| pajas | 408 |
| pala | 248, 454-455 |
| pala de hielo | 406 |
| pala de pizza | 479 |
| pala de tartas | 439, 441 |
| pala para harina | 470, 481 |
| paleta para servir | 230, 441 |
| paleta pastelera | 459 |
| panera | 320-322 |
| papel alimenticio | 111, 114, 126, 236, 251, 420 |
| papelera de sobremesa | 295-296 |
| pelador reversible | 457 |
| picadora de hielo | 406 |
| pie porta champañera / vino | 374 |
| pie porta vino | 374 |
| pinchanotas | 473 |
| pinza | 407, 445-452 |
| pinza bogavante | 462 |
| pinza de emplatar | 407, 452 |
| pinza ensalada | 445-449 |
| pinza exprime limón | 418 |
| pinza para aperitivos | 449 |
| pinza para cubitos de hielo | 407 |
| pinza para pasteles | 446-447, 450-451 |
| pinza universal | 446 |
| pizarra | 24, 28, 87, 112-116, 120-121, 244, 249-250, 256 |

| | | | |
|----------------------------------|--|------------------------------------|---|
| placa de inducción | 76, 334, 336-338, 340-341, 349 | tapa hermética | 19, 286 |
| plato esmaltado | 279 | tapete escurridor | 409 |
| plato melamina | 144, 146-148, 160, 162, 164, 175, 192, 194, 198, 204, 208, 217, 222 | tapón antipolvo | 410 |
| plato para el aperitivo | 204 | tapón vertedor | 412 |
| polvoreador | 257-258, 465 | tartetas | 298-301 |
| porcelana | 46, 338, 340 | tarros gourmet | 285 |
| porcionador de pastel | 439 | taza | 39-40, 123, 218, 240, 270, 280, 305, 385, 387-396, 427-432, 434, 467-468, 497 |
| porta cubiertos | 21, 137-138, 295, 312, 366-367 | taza de café | 280, 305, 432 |
| porta cubiertos | 294, 317 | tenedor de carne | 439, 442-443 |
| porta cuenta | 293, 426 | tenedor de ensalada | 438, 441, 454 |
| porta menú | 297-302 | termómetro | 415 |
| porta vasos de cerveza | 131, 423 | tetera ASIA | 57, 419 |
| portafichas | 473 | timbre | 426 |
| porta-tartetas | 297-302 | tubo enfriador para cubitos | 36, 52-53, 383 |
| portavelas antiviento | 274 | V | |
| posavasos acero inoxidable | 293 | vaciador de melón redondo | 456 |
| posavasos pizarra natural | 114, 250, 256 | vaso | 38, 386 |
| prensa de limón | 403, 472 | vaso agitador | 468 |
| R | | vaso coctelero | 280 |
| rack de copas | 392 | vaso mezclador vertedor | 411 |
| rack dispensador de cuencos | 79 | vaso para servir | 232-239 |
| rebanador de queso | 458 | vaso reutilizable | 305, 432, 497 |
| recipiente de ingredientes | 401 | vaso To-Go | 305, 432, 497 |
| recipiente organizador | 294-296, 312, 368, 401 | vasos | 39-40, 385, 387 |
| recipiente para masa | 368, 480 | vertedor continuo | 412 |
| recogemigas | 292, 426 | vertedores | 50-51, 260-263, 265-266, 369, 400, 411-412, 470 |
| reposa cuchara | 218, 351 | vitrina de buffet | 25-28, 34 |
| resistencia | 47, 348-350 | vitrina de buffet acero inoxidable | 25-26, 28, 34 |
| ribeteador de vasos | 409 | W | |
| rizador | 84, 458, 466 | Weck-botellas | 65, 282-286 |
| rotulador de tiza | 304 | | |
| S | | | |
| sacacorchos | 413 | | |
| sacacorchos de camarero | 413 | | |
| salsera | 291-292 | | |
| salsera acero inoxidable | 73 | | |
| salsera melamina | 73 | | |
| salsera porcelana | 73 | | |
| sartén de hierro fundido | 231 | | |
| Servidor de ensalada | 438, 454 | | |
| servilletero | 139-141 | | |
| servilleteros/aros | 293 | | |
| set de buffet | 93 | | |
| set de buffet refrigerado | 18, 112 | | |
| set para fondue | 271, 347 | | |
| set para servir | 150-151 | | |
| set rolltop | 30, 106, 115 | | |
| snackbox | 126-127, 230, 243 | | |
| soplete de cocina para flambeo | 474 | | |
| soporte | 61, 66, 69, 74-75, 84, 96-98, 157, 179-180, 184, 216-217, 271, 287, 328, 474 | | |
| soporte a pedal | 431 | | |
| soporte campana | 94 | | |
| soporte cucurucho | 474 | | |
| soporte de pretzels o salchichas | 84 | | |
| soporte para botella de vino | 382 | | |
| soporte para brochetas | 274 | | |
| soporte para pastel | 105, 115, 122, 131-135, 216, 288-289 | | |
| soporte para tablas de cortar | 474 | | |
| soporte platos | 79, 84-86, 286 | | |
| superbox | 21-24, 330-331 | | |
| T | | | |
| tabla de corte | 59, 88, 130 | | |
| tabla de servir | 83, 119-126, 128-129, 242-249 | | |
| tabla para cortar | 15, 88-89, 130, 401 | | |
| tabla para el buffet | 52, 117-118, 129 | | |
| tapa | 65, 77, 209-210, 214, 225, 286, 355-358, 480, 493-495 | | |
| tapa acero inoxidable | 355-356 | | |

FRANÇAIS

| item | pág. |
|--|--|
| A | |
| accumulateur de froid | 27-34, 42, 496 |
| adaptateur | 354, 356 |
| anneaux à serviettes | 293 |
| ardoise | 24, 28, 87, 112-116, 120-121, 244, 249-250, 256 |
| articles en email | 211, 270, 279-280, 287 |
| assiette de présentation | 292 |
| assiette email | 279 |
| assiette mélamine | 144, 146-148, 160, 162, 164, 175, 192, 194, 198, 204, 208, 217, 222 |
| assiette pour apéritif | 204 |
| B | |
| Bain-Marie | 335-336, 338-340, 343-346, 348, 466 |
| barre aimantée pour couteaux | 473 |
| barre porte-bons | 473 |
| base bois | 128, 246, 272-273 |
| bassine à glace | 55, 377 |
| Bento Box | 156-157 |
| béton | 141, 168, 260, 272, 274-275, 298, 381, 384 |
| beurrer | 270 |
| boîte à lunch | 329, 435 |
| boîte à œufs | 368, 477 |
| boîte à pain pour le buffet | 88, 93, 318-319, 326-327 |
| boîte à thés et infusions | 58 |
| boîte de buffet | 70 |
| boîte-repas | 187 |
| bol acier inox | 19, 102, 229, 232, 235-237, 327 |
| bol aluminium | 237, 323 |
| bol béton | 74 |
| bol bois | 69, 119, 127-128, 241-242, 495 |
| bol email | 279-280, 287 |
| bol en verre | 77, 106 |
| bol mélamine | 145-154, 156, 160, 162-165, 167-169, 172, 174, 176, 179, 181-186, 190-191, 194-199, 201-223, 493 |
| bol mélangeur | 280 |
| bol mini | 212, 220-221, 232-233, 235, 257, 269, 394, 416, |
| bol récupérateur de capsules | 56 |
| bol réfrigéré | 19, 31-33 |
| bordeur à verres | 409 |
| bouchon anti-poussières et anti-insectes | 410 |
| bouchons verseurs | 50-51, 260-263, 265-266, 369, 400, 411-412, 470 |
| boule à thé avec pince | 418 |
| bouteille | 52-53, 266, 281, 411, 413, 433, 475-476 |
| bouteille store & pour | 411, 475-476 |
| bouteille de combustible liquide | 350 |
| bouteille isotherme | 47-49 |
| bouteille verseuse souple | 475-476 |
| brosse lave | 412 |
| broyeur à glaçons | 406 |
| C | |
| caddy | 126, 141, 246, 272-273, 296, 409 |
| caddy de table | 126, 128, 141, 246, 272-273 |
| cadre support inox pour plaque induction | 336-338, 349 |
| caisson thermo | 35 |
| carafe en verre | 50-53 |
| casserole | 102, 231-233 |
| casserole à moules | 287 |
| cendrier | 427-430 |
| cendrier sur pied | 430 |
| cercle à gâteaux | 469 |
| cercle à mousse rond | 468 |
| Chafing Dish | 334-346 |
| Chafing Dish Rolltop | 348 |
| chalumbeau e cuisine | 474 |
| chandelier | 274 |
| chariot | 365 |
| chariot de service | 360, 364-365 |
| chauffe-plat | 350 |
| chauffe-théière | 58 |
| chevalets de table | 300, 304 |
| chinois | 464 |
| cloche | 14, 16-17, 94, 99-102, 104-107, 122, 136, 166, 170, 180, 217, 290, 316, 318, 348, 484-497 |
| cloche demi-sphère | 292, 426 |
| cloche rolltop | 16-17, 25-30, 102, 112, 129, 217, 315, 348, 487 |
| cloche rolltop acier inox | 348 |
| coquetier | 218, 270 |
| corbeille | 320-322 |
| corbeille à baquette | 92, 310, 316 |
| corbeille à petits pains | 215 |
| corbeille acier inox | 234, 326-327 |
| corbeille de buffet | 16, 93, 314-315, 319 |
| corbeille de service | 234, 237 |
| corbeille métal | 234, 323-325, 327-328 |
| corbeille polypropylène | 294, 308-319 |
| coupe-œufs | 462 |
| coupe-pâte | 461, 480 |
| coupe-pizza | 457, 462, 480 |
| couteau à huitres | 458 |
| couteau à tarte | 439 |
| couteau à tartiner | 461 |
| couteau cannelé | 401, 458 |
| couteau cocktail | 401 |
| couteau tranche-fromage | 458 |
| couteau zesteur | 456 |
| couvercle | 65, 77, 209-210, 214, 225, 286, 355-358, 480, 493-495 |
| couvercle acier inox | 355-356 |
| couvercle hermétique | 19, 286 |
| couvert à salade | 438, 454 |
| cuillère | 218-220, 240, 399, 438-445, 453, 455, 465 |
| cuillère à cocktail | 399 |
| cuillère à glace | 474 |
| cuillère à miel | 455 |
| cuillère à salade | 218, 438, 441, 454 |
| cuillère à sauce | 441, 453, 481 |
| cuillère à spaghettis | 440 |
| cuillère de service | 218, 438, 440-443, 445 |
| cuillère gourmet | 240, 453 |
| cuillère party | 200, 219-220 |
| cuillère party | 2000, 219-220 |
| cuillère pâtisserie | 465 |
| D | |
| décapsulateur | 56, 413 |
| dénoyauteur | 457 |
| dérouleur de film | 473 |
| distributeur de petits pains acier inox | 93 |
| distributeur à jus | 20, 41, 43-45 |
| distributeur à lait | 20, 44-46, 235, 269, 414-416 |
| distributeur de boisson isothermique | 41 |
| distributeur de boissons | 36-40, 383-384 |
| distributeur de café acier inox | 47, 348 |
| distributeur de céréales | 21, 59-62 |
| distributeur de céréales acero inox | 21, 59-62 |
| distributeur de snacks | 240, 393 |
| doseur à sauce | 477 |
| E | |
| écumoire | 440, 445 |
| égouttoir à friture | 465 |
| entonnoir à piston | 466 |
| étagère | 67-68, 82-87, 116, 186, 216 |
| étiquettes | 297-301, 304, 495 |
| F | |
| flacon pulvérisateur | 266, 411 |

| | | | | | | | |
|----------------------------------|--|-------------------------------------|---|-------------------------------|---|------------------------------|----------------|
| forme à gateaux | 469, 478-479 | pelle à gâteaux | 439, 441 | pot à épices | 257-258, 465 | tapis égouttoir | 409 |
| fouet | 462 | pelle à glaçons | 406 | pot à sauce acier inox | 73 | tasse à café | 280, 305, 432 |
| fourchette à salade | 438, 441, 454 | pelle à pizza | 479 | pot à sauce mélamine | 73 | tasse à remuer | 468 |
| fourchette à viande | 439, 442-443 | petits chevaux de buffet | 20, 45, 304, 495 | pot à sauce porcelaine | 73 | tasse réutilisable | 305, 432, 497 |
| fourchette de service | 438-439, 442-443, 453 | pichet | 45-50, 52-54, 57, 235, 269, 380, 414-416, 419 | pot de moutarde | 261 | tasse To-Go | 305, 432, 497 |
| frisette | 84, 458, 466 | pichet à café | 415 | pot verseur universel | 368-369, 416 | théière ASIA | 57, 419 |
| G | | pichet à jus de fruit | 50, 52-53 | poubelle de table | 295-296 | thermomètre | 415 |
| gants de boulanger | 478 | pichet à lait | 235, 269 | présentoir à assiettes | 79, 84-86, 286 | tire-bouchons | 413 |
| GN bac | 15, 24, 100, 224-225, 353-354, 357-359, 361-363 | pichet gradué | 467-468 | présentoir à gâteaux | 105, 115, 122, 134-135, 216, 288-289, 311 | truille de service | 230, 441 |
| GN bac acier inoxydable | 100, 353-354 | pichet rafraîchisseur | 50 | présentoir à sandwiches | 92 | tube pour glaçons | 36, 52-53, 383 |
| GN bol mélamine | 153-154, 182, 224-225 | piéd pour seau à champagne / vin | 374 | présentoir buffet | 61, 66, 69, 74-75, 91, 93, 96-98, 118, 157, 184, 217, 287 | V | |
| GN Chafing Dish | 335-336, 338-339, 343-346 | pilon muddler | 402 | présentoir buffet acier inox | 98 | verre mélangeur | 411 |
| GN cloche | 17, 99-100, 316, 318, 348, 484-487 | pince à asperges | 486 | présentoir buffet bois | 61, 66, 74-75, 98 | verres gourmet | 285 |
| GN corbeille | 16, 309, 312-314, 324 | pince à dressers | 407, 452 | présentoir buffet en escalier | 77, 78, 80-81, 93 | verseurs continus | 412 |
| GN corbeille métal | 324 | pince à gâteaux | 446-447, 450-451 | | | vitrine de buffet | 25-28, 34 |
| GN corbeille polypropylène | 16, 309, 312-314 | pince à glaçons | 407 | | | vitrine de buffet acier inox | 25-26, 28, 34 |
| GN couvercle | 225, 355-358, 362 | pince à homard | 462 | | | | |
| GN égouttoir | 356, 358 | pince à salade | 445-449 | | | | |
| GN grille | 360 | pince à spaghetti | 445, 449 | | | | |
| GN planche de service | 424 | pince universelle | 446 | | | | |
| GN plateau | 153, 156, 159, 161, 166, 169-170, 173, 183, 185, 188, 193, 202, 204, 206-207 | pinceau pâtissier | 272, 281 | | | | |
| GN plateau acier inox | 15, 29, 99-101, 204 | pique-bons | 473 | | | | |
| GN plateau ardoise naturelle | 24, 250 | planche à découper | 15, 59, 88-89, 130, 401 | | | | |
| GN plateau buffet acier inox | 25-26, 28 | planche à découper buffet | 52, 117-118, 129 | | | | |
| GN plateau mélamine | 24, 66, 153, 156, 159, 161, 166, 169-170, 173, 183, 185, 188, 193, 202, 204, 206-207 | planche de service | 83, 119-126, 128-129, 242-249 | | | | |
| GN plateau party | 108 | plaque à induction | 76, 334, 336-338, 340-341, 349 | | | | |
| GN plateau porcelaine | 15, 360 | plaque à pâtisserie | 251, 469 | | | | |
| GN présentoir buffet | 157, 316 | plaque à pâtisserie | 111, 251, 360 | | | | |
| GN présentoir buffet en escalier | 80-81 | plat à gâteau acier inox | 105, 135, 289 | | | | |
| GN range couverts | 137-138, 312, 360, 367 | plat à gâteau bois | 122, 134-135, 288-289 | | | | |
| GN support buffet | 17 | plat à gâteau mélamine | 134, 216, 288 | | | | |
| gobelet | 39-40, 123, 218, 240, 270, 280, 305, 385, 387-396, 427-432, 434, 467-468, 497 | plat à sauter | 233 | | | | |
| gobelet à apéritif | 232-239 | plat ardoise naturelle | 24, 87, 112-116, 120-121, 249-250, 256 | | | | |
| H | | plat pour la table | 102, 232-233 | | | | |
| housse de protection | 48 | plateau | 14-15, 24, 27, 29, 35, 72, 83, 88, 94, 99-106, 109-111, 124-125, 131-133, 144, 146-148, 153, 156, 159-161, 163, 166, 169-174, 179, 183, 185-189, 192-194, 198, 200, 202, 204, 206-207, 210, 215, 217, 246, 251, 360, 421-424, 426 | | | | |
| housse isotherme | 382 | plateau acier inox | 14-15, 34-35, 99-106, 109-111, 228, 251, 293, 420-422, 426 | | | | |
| J | | plateau bois | 83, 88, 94, 107, 124-125, 132, 243, 246-247, 424 | | | | |
| jeu de cuillère à mesure | 451 | plateau feuille de palme mélamine | 176, 190, 214 | | | | |
| L | | plateau feuille mélamine | 176, 217, 490 | | | | |
| louche | 438, 440, 442-443, 445 | plateau mélamine | 83, 88, 144, 146-148, 153, 156, 159-161, 163, 166, 169-174, 179, 183, 185-189, 192-194, 198, 200, 202, 204, 206-207, 210, 215, 217, 363 | | | | |
| louche de service | 441, 443, 445 | plateau party | 108 | | | | |
| M | | plateau self-service et snacks | 133, 425 | | | | |
| mandoline | 466 | plateau sushi en bois | 124, 247 | | | | |
| marmite | 337, 345-346 | plateau sushi mélamine | 147-148, 198 | | | | |
| marmite petite de servir | 106, 232-233 | plateaux réfrigérés | 14, 27, 29 | | | | |
| marqueur à la craie liquide | 304 | plucheur droitier/gaucher | 457 | | | | |
| mesure jigger | 397, 398 | pochette à serviettes | 277 | | | | |
| Moscow Mule gobelet | 388-390 | pochette couverts | 277 | | | | |
| moule à boule ronde simple | 456 | poêle en fonte | 231 | | | | |
| moule à glaçons | 404 | pompe de dosage | 477 | | | | |
| moule à glaçons en boules | 404 | porcelaine | 46, 338, 340 | | | | |
| moule à pizza | 478-480 | porte verres à bière | 131, 423 | | | | |
| moules à flan | 469 | porte-addition | 293, 426 | | | | |
| moulin à poivre | 252-257, 266, 465 | porte-bols | 79 | | | | |
| moulin à sel | 252-258, 266, 465 | porte-bouteille à vin | 382 | | | | |
| multibox | 58 | porte-cartes | 297-302 | | | | |
| N | | porte-clés avec câble à enroulement | 410 | | | | |
| organisateur bar caddy | 409 | porte-épices | 265 | | | | |
| P | | porte-épices | 265 | | | | |
| panier à œufs | 311 | porte-serviettes | 139-141 | | | | |
| panier en corde au crochet | 322 | pose-cuillère | 218, 351 | | | | |
| panier pour le service sur table | 114, 234 | | | | | | |
| pare-haleine | 84, 90, 93 | | | | | | |
| passoire | 463-464 | | | | | | |
| peleur | 456 | | | | | | |
| pelle | 248, 454-455 | | | | | | |
| pelle à farine | 470, 481 | | | | | | |





Buffet & Display

| | |
|--------------------------------------|-----|
| FRAMES | 14 |
| BRIDGE | 18 |
| SUPERBOX | 22 |
| COOLING DISPLAYS | 25 |
| BEVERAGE DISPENSERS | 36 |
| VACUUM JUGS | 48 |
| CARAFES | 50 |
| BEVERAGE BOWLS | 54 |
| TEAPOTS | 57 |
| CEREAL DISPENSERS | 59 |
| CANISTERS | 63 |
| BUFFET DISPLAY | 66 |
| ETAGERES | 82 |
| CUTTING BOARDS | 88 |
| BUFFET GUARDS SHOWCASES | 90 |
| MULTI RACKS | 95 |
| BUFFET STANDS | 96 |
| TRAYS BOARDS | 99 |
| SERVING BOARDS NATURAL SLATE | 112 |
| SERVING BOARDS WOOD | 117 |
| TRAYS | 131 |
| FAST FOOD TRAYS | 133 |
| CAKE STANDS | 134 |
| SUPER DOME | 136 |
| CUTLERY BOXES | 137 |
| NAPKIN HOLDERS | 139 |

FRAMES



Die reduzierte, archetypische Formsprache von FRAMES nimmt sich elegant zurück und lässt damit viel Raum für die Inszenierung der Buffet-Speisen. Ein scheinbarer Widerspruch löst sich auf: das Design ist zeitgemäß und zeitlos zugleich.

Design in detail – The classic minimalist visual style of FRAMES is elegantly understated, leaving plenty of potential for creating appealing buffet arrangements. Its design transcends what at first seems to be an irreconcilable paradox, being at once both timeless and highly contemporary.

Diseño en detalle - El estilo visual clásico y minimalista de FRAMES es elegantemente sobrio, dejando mucho potencial para crear atractivas composiciones para el buffet. Su diseño supera lo que a primera vista parece una paradoja irreconciliable, siendo a la vez intemporal y muy contemporáneo.

Le design dans le détail - Le style visuel minimaliste classique de FRAMES est élégamment discret, laissant beaucoup de potentiel pour créer des arrangements de buffet attrayants. Son design transcende ce qui semble à première vue être un paradoxe irréconciliable, étant à la fois intemporel et très contemporain.



Kühltablets SET 1 „FRAMES“

cooling plates
bandejas refrigeradas
plateaux réfrigérés



GN 1/1 Basiselement, GN 1/1 Edelfstahl Tablett 18/10, Kühlakku
GN 1/1 base element, GN 1/1 stainless steel platter 18/10, cooler
elemento básico GN 1/1, bandeja GN 1/1 de acero inoxidable 18/10, acumulador de frío
élément de base GN 1/1, plateau GN 1/1 en acier inox 18/10, accumulateur de froid

| | cm | ↑ cm | GN | Farbe / Colour | |
|-------|-----------|------|-----|----------------|-----------------|
| 12940 | 53 x 32,5 | 8,5 | 1/1 | | stainless steel |
| 14940 | 53 x 32,5 | 8,5 | 1/1 | | wenge wood |
| 13940 | 53 x 32,5 | 8,5 | 1/1 | | maple wood |



Kühltablets SET 2 „FRAMES“

cooling plates
bandejas refrigeradas
plateaux réfrigérés



GN 1/1 Basiselement, GN 1/1 Edelfstahl Tablett 18/10, Rolltophaube, Kühlakku
GN 1/1 base element, GN 1/1 stainless steel platter, rolltop cover, cooler
elemento básico GN 1/1, bandeja GN 1/1 de acero inoxidable 18/10, campana rolltop, acumulador de frío
élément de base GN 1/1, plateau GN 1/1 en acier inox 18/10, cloche rolltop, accumulateur de froid

| | cm | ↑ cm | GN | Farbe / Colour | |
|-------|-----------|------|-----|----------------|-----------------|
| 12941 | 53 x 32,5 | 27,5 | 1/1 | | stainless steel |
| 14941 | 53 x 32,5 | 27,5 | 1/1 | | wenge wood |
| 13941 | 53 x 32,5 | 27,5 | 1/1 | | maple wood |



Schneidebrett „FRAMES“

cutting board
tabla de cortar
planche à découper

Ahorn, massiv
maple wood, solid
madera de arce, maciza
bois d'érable, massif



| | cm | ↑ cm | GN |
|-------|-----------|------|-----|
| 13955 | 53 x 32,5 | 2,5 | 1/1 |



Schneidebrett „FRAMES“

cutting board
tabla de cortar
planche à découper



| | cm | ↑ cm | GN |
|-------|-----------|------|-----|
| 17910 | 53 x 32,5 | 2,5 | 1/1 |



82355
GN 1/1

GN Tablett „FRAMES“

GN tray
GN bandeja
GN plateau

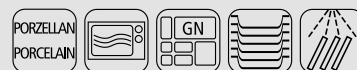

| | cm | ↑ cm | GN |
|-------|-------------|------|-----|
| 82355 | 53,0 x 32,5 | 2 | 1/1 |
| 82356 | 32,5 x 26,5 | 2 | 1/2 |
| 82357 | 32,5 x 17,6 | 2 | 1/3 |



11119

11118

GN Edelstahl Tablett „FRAMES“

GN stainless steel platter
GN bandeja acero inoxidable
GN plateau acier inox



| | cm | ↑ cm | GN |
|-------|-------------|------|-----|
| 11119 | 53,0 x 32,5 | 2 | 1/1 |
| 11118 | 32,5 x 26,5 | 2 | 1/2 |



84046

GN Tablett „FRAMES“

GN tray
GN bandeja
GN plateau



| | cm | ↑ cm | GN |
|-------|-------------|------|-----|
| 84046 | 53,0 x 32,5 | 2 | 1/1 |
| 84047 | 32,5 x 26,5 | 2 | 1/2 |
| 84048 | 32,5 x 17,6 | 2 | 1/3 |



GN Wanne „FRAMES“

GN tray
GN bandeja
GN plateau



| | cm | ↑ cm | GN |
|-------|-----------|------|-----|
| 17922 | 53 x 32,5 | 8 | 1/1 |

FRAMES



Korb „GN LINE“

GN basket

GN cesta

GN corbeille



stabile Ausführung mit Edelstahldraht im Rand zur Stabilisierung

very solid with stainless steel wire frame to stabilize the basket

muy resistente con alambre de acero inoxidable en el borde para la estabilización

très résistante avec fil d'acier inox dans le bord pour la stabilisation

| | cm | ↑ cm | GN |
|-------|-------------|------|-----|
| 40291 | 53,0 x 32,5 | 6,5 | 1/1 |
| 40290 | 32,5 x 26,5 | 6,5 | 1/2 |
| 40293 | 53,0 x 32,5 | 10,0 | 1/1 |
| 40292 | 32,5 x 26,5 | 10,0 | 1/2 |



Buffetkorb „ECONOMIC“

basket

cesta

corbeille

Polyrattan, mit Haubenschiene (ohne Haube)

polyrattan, with frame to fix the cover (without cover)

polyrattan, con fijación para campana (sin campana)

polyrattan, avec fixation pour la cloche (sans cloche)



| | cm | ↑ cm |
|-------|-------------|------|
| 40294 | 56,5 x 36,0 | 10 |



Buffetkorb „ECONOMIC“

buffet basket

cesta de buffet

corbeille de buffet

Polyrattan, mit Haubenschiene (ohne Haube)

polyrattan, with frame to fix the cover (without cover)

polyrattan, con fijación para campana (sin campana)

polyrattan, avec fixation pour la cloche (sans cloche)



| | Ø cm | ↑ cm |
|-------|------|------|
| 40295 | 40 | 12,5 |



Rolltophaube

rolltop cover

campana abatible

cloche basculante



| | Ø cm | ↑ cm |
|-------|------|------|
| 18389 | 38 | 20 |



Eisbox „FRAMES“

ice box

bandeja para hielo

caisse à glaçons

3-teilig: 1 Basiselement Wenge + 1 Polystyrolwanne + 1 Tropfgitter

3 pcs. set: 1 box wenge + 1 plastic deep tray + 1 drainer plate

set de 3: 1 cajón color wengué + 1 cubeta plástico + 1 rejilla

set de 3: 1 caisson couleur wengé + 1 bac plastique + 1 plaque perforée



| | cm | ↑ cm | GN | Farbe / Colour |
|-------|-----------|------|-----|----------------|
| 14970 | 53 x 32,5 | 12,5 | 1/1 | ■ |



vielseitig einsetzbar für alle GN 1/1 Artikel



11008
2x 85146
GN 1/2

passendes Kühltablett Set

Gestell für GN 1/1 „FRAMES“

serving stand GN 1/1
soporte para GN 1/1
support pour GN 1/1

Buche massiv, Wenge
solid beech, colour wenge
haya maciza, color wengué
hêtre massif, couleur wengé



| | cm | ↑ cm | Farbe / Colour |
|-------|-------------|------|----------------|
| 14953 | 57,5 x 27,5 | 22 | |



84047
GN 1/2

84047
GN 1/2

passendes Kühltablett Set



14956

14953

passende Besteck / Universal-Box GN 1/1



14954

Einsatz / insert

Besteck- / Universal-Box, 2-teilig „FRAMES“

cutlery tray, 2 pcs.
cubertero o cajón multi-usos, set de 2
caisson à couverts ou multi-usages, set de 2

Buche massiv, Wenge, 4 Fächer, inklusive herausnehmbaren Einsatz
solid beech, colour wenge, 4 compartments, including removable insert
haya maciza, color wengué, 4 compartimentos, con separador extraíble
hêtre massif, couleur wengé, 4 compartiments, avec insert amovible



| | cm | ↑ cm | GN | Farbe / Colour |
|-------|-----------|------|-----|----------------|
| 14956 | 53 x 32,5 | 11 | 1/1 | |

Einsatz für GN 1/1 „FRAMES“ / insert for GN1/1 / separador para GN1/1 / insert pour GN1/1

| | cm | ↑ cm | Farbe / Colour |
|-------|-----------|------|----------------|
| 14954 | 48,5 x 28 | 8 | |



GN 1/1 Rolltophaube

GN 1/1 rolltop cover
GN 1/1 campana abatible
GN 1/1 cloche basculante

verchromter Zinkdruckguss-Griff
chrome plated metal handle
mango cromado de fundición a presión de zinc
poignée en zinc moulé sous pression chromé



| | cm | ↑ cm | GN |
|-------|-----------|------|-----|
| 11018 | 53 x 32,5 | 17 | 1/1 |



GN 1/1 Rolltophaube

GN 1/1 rolltop cover
GN 1/1 campana abatible
GN 1/1 cloche basculante

patentiert, passend für GN-Behälter, -Tablets, etc., leichtgängig auf- und zuklappbar 90°
patented, suitable for GN containers, trays, etc., solid quality, 90° opening
patentada, para contenedores, bandejas GN, apertura 90°
brevetée, pour bacs, plateaux GN, ouverture 90°



| | cm | ↑ cm | GN |
|-------|-----------|------|-----|
| 11008 | 53 x 32,5 | 17 | 1/1 |



Mit hohem Anspruch an Design und Funktionalität haben wir das Buffet-System „Bridge“ für Sie entwickelt. Die in den Holzoberflächen Ahorn und Wenge erhältlichen Artikel sind in ihren Höhen und ihren Volumina optimal aufeinander abgestimmt und gewährleisten einen einfachen und sicheren Umgang in Ihrem Gastronomiealltag.

The collection "Bridge" is bringing perfectly coordinated components for an uncomplicated and organized buffet system, finalizing in a unique buffet scenery. All pieces combine perfectly with one another in their variations of sizes and volumes. The wooden items are available in 2 colors, maple or wenge. A simple and safe handling is guaranteed.

Una colección universal para un buffet único: un Sistema funcional y fácil de componer, asociado a la elegancia de su exclusivo diseño. Los elementos se combinan a la perfección entre variaciones de Alturas y volúmenes, realizando sus propuestas y composiciones culinarias y modelando el paisaje del buffet. Las piezas están disponibles en 2 colores, wengué o arce. Manejo sencillo y seguro.

Une collection universelle pour une présentation unique de votre buffet: fonctionnel et facile à composer, ce système est à la fois pratique, simple et spectaculaire par son élégant design. Les différents éléments se marient à la perfection pour construire sans difficulté différentes compositions, variant les hauteurs et les volumes et mettant en valeur vos créations culinaires. Les pièces sont disponibles en deux couleurs, bois wengé ou érable.



Kühlbox „BRIDGE“
refrigerated buffet display
set de buffet refrigerado
présentoir buffet froid



Set bestehend aus: 1 Gestell aus Ahorn oder Wenge, 1 Behälter aus Kunststoff, 1 GN1/1 Tablett aus Melamin, 1 Kühlakku, 1 Rolltophaube (fix montiert)

set consists of: 1 base element maple or wenge, 1 plastic insert black, 1 GN1/1 tray melamine, 1 cooler, 1 cover (fixed)

set compuesto por: 1 soporte de madera arce o wengué, 1 cubeta de plástico, 1 bandeja de melamina GN 1/1, 1 acumulador de frío, 1 campana rolltop (fija)

set composé de: 1 support en bois érable ou wengé, 1 bac plastique, 1 plat en mélamine GN 1/1, 1 accumulateur de froid, 1 cloche rolltop (fixe)

| | cm | ↑ cm | Farbe / Colour | |
|-------|-------------|------|----------------|------------|
| 13990 | 63,5 x 42,5 | 31 | | ahorn wood |
| 14990 | 63,5 x 42,5 | 31 | | wenge wood |

**Kühlschale „BRIDGE“**cooling bowl
bol refrigerado
bol réfrigéré4-teilig: 1 Gestell aus Ahorn oder Wenge, 1 Behälter aus Edelstahl,
1 Schale aus Melamin (Ø 14 cm o. 23 cm), 1 Kühlakku4 pcs.: 1 base element maple or wenge, 1 bowl stainless steel,
1 bowl melamine (Ø 14 or 23 cm), 1 coolerset de 4: 1 soporte de madera arce o wengué, 1 cuenco
de acero inoxidable, 1 cuenco de melamina (Ø 14 cm o 23 cm), 1 acumulador de fríoset de 4: 1 support en bois érable ou wengé, 1 bol en acier inox, 1 bol en mélamine
(Ø 14 cm ou 23 cm), 1 accumulateur de froid

| | cm | ↑ cm | ltr. | Farbe / Colour |
|-------|-------------|------|------|----------------|
| 13980 | 18,5 x 18,5 | 10 | 0,5 | |
| 13981 | 27,5 x 27,5 | 14 | 2,5 | |

| | cm | ↑ cm | ltr. | Farbe / Colour |
|-------|-------------|------|------|----------------|
| 14980 | 18,5 x 18,5 | 10 | 0,5 | |
| 14981 | 27,5 x 27,5 | 14 | 2,5 | |

**Edelstahlschale „BRIDGE“**stainless steel bowl
cuenco acero inoxidable
bol acier inox

| | Ø cm | ↑ cm |
|-------|------|------|
| 30050 | 14 | 8,5 |
| 30052 | 23 | 13,5 |

**Schale „CASUAL MAXI“**bowl
cuenco
bol

| | Ø cm | ↑ cm | ltr. | Farbe / Colour |
|-------|------|------|------|----------------|
| 83700 | 14 | 6,5 | 0,5 | |
| 83702 | 23 | 10,5 | 2,5 | |

| | Ø cm | ↑ cm | ltr. | Farbe / Colour |
|-------|------|------|------|----------------|
| 83701 | 14 | 6,5 | 0,5 | |
| 83703 | 23 | 10,5 | 2,5 | |

**Frischhaltedeckel**airtight cover
tapa hermética
couvercle hermétique

| | Ø cm |
|-------|------|
| 10890 | 14 |
| 10887 | 23 |

Kühlakku / cooler / acumulador de frío / accumulateur de froid

| | Ø cm | ↑ cm |
|-------|------|------|
| 10661 | 10,5 | 2,0 |
| 10777 | 15,0 | 2,5 |



Milchdispenser „BRIDGE“

milk dispenser
dispensador de leche
distributeur à lait



Edelstahl Dispenser mit 1 Kühllakku im Standfuß inklusive touchless adapter

stainless steel dispenser with 1 cooling element in stand including touchless adapter
dispensador de acero inoxidable con 1 acumulador de frío en la base y con adaptador sin contacto para grifo
distributeur en acier inox avec 1 accumulateur de froid dans le socle et avec adaptateur sans contact manuel

| | cm | ↑ cm | ltr. | Farbe / Colour |
|-------|---------|------|------|----------------|
| 10836 | 31 x 20 | 39 | 3 | Ahorn / maple |
| 10838 | 39 x 22 | 45 | 5 | Ahorn / maple |



Milchdispenser „BRIDGE“

milk dispenser
dispensador de leche
distributeur à lait



Edelstahl Dispenser mit 1 Kühllakku im Standfuß inklusive touchless adapter

stainless steel dispenser with 1 cooling element in stand including touchless adapter
dispensador de acero inoxidable con 1 acumulador de frío en la base y con adaptador sin contacto para grifo
distributeur en acier inox avec 1 accumulateur de froid dans le socle et avec adaptateur sans contact manuel

| | cm | ↑ cm | ltr. | Farbe / Colour |
|-------|---------|------|------|----------------|
| 10837 | 31 x 20 | 39 | 3 | Buche / beech |
| 10839 | 39 x 22 | 45 | 5 | Buche / beech |



Saftdispenser „BRIDGE“

juice dispenser
dispensador de zumo
distributeur à jus



Kühlung durch 2 Kühllakkus von oben und unten

cooling with 2 cooling elements from the top and base
2 acumuladores de frío: 1 en la base y 1 en la tapa
2 accumulateurs de froid: 1 dans le couvercle et 1 dans le socle

| | cm | ↑ cm | ltr. | Farbe / Colour |
|-------|-----------|------|------|----------------|
| 10870 | 31,0 x 20 | 42 | 4 | Ahorn / maple |
| 10871 | 35,5 x 22 | 50 | 6 | Ahorn / maple |



inklusive 3 Magnetschilder: ORANGE, APPLE, GRAPEFRUIT
including 3 magnetic signs: ORANGE, APPLE, GRAPEFRUIT



Saftdispenser „BRIDGE“

juice dispenser
dispensador de zumo
distributeur à jus



Kühlung durch 2 Kühllakkus von oben und unten

cooling with 2 cooling elements from the top and base
2 acumuladores de frío: 1 en la base y 1 en la tapa
2 accumulateurs de froid: 1 dans le couvercle et 1 dans le socle

| | cm | ↑ cm | ltr. | Farbe / Colour |
|-------|-----------|------|------|----------------|
| 10872 | 31,0 x 20 | 42 | 4 | Wenge / wenge |
| 10873 | 35,5 x 22 | 50 | 6 | Wenge / wenge |



inklusive 3 Magnetschilder: ORANGE, APPLE, GRAPEFRUIT
including 3 magnetic signs: ORANGE, APPLE, GRAPEFRUIT



Cerealispender „BRIDGE“

cereal dispenser
dispensador de cereales
distributeur de céréales



Behälter herausnehmbar, „Feierabend-Deckel“ für das aromadichte Lagern, Portionieren durch einfaches Drehen

removable canister, special lid to keep the cereals fresh, easy to use, rotate the button to get the muesli

contenedor extraíble, tapa especial para mantener los cereales frescos, fácil de usar, se gira el pomo para servir los cereales

réceptif amovible, couvercle spécial pour conserver les céréales, usage facile en tournant le bouton

| | cm | ↑ cm | ltr. | Farbe / Colour | |
|-------|---------|------|------|----------------|---------------|
| 13987 | 21 x 20 | 55,5 | 4,5 | | Ahorn / maple |



Cerealispender „BRIDGE“

cereal dispenser
dispensador de cereales
distributeur de céréales



Behälter herausnehmbar, „Feierabend-Deckel“ für das aromadichte Lagern, Portionieren durch einfaches Drehen

removable canister, special lid to keep the cereals fresh, easy to use, rotate the button to get the muesli

contenedor movible, tapa especial para mantener los cereales frescos, fácil de usar, se gira el pomo para servir los cereales

réceptif amovible, couvercle spécial pour conserver les céréales, usage facile en tournant le bouton

| | cm | ↑ cm | ltr. | Farbe / Colour | |
|-------|---------|------|------|----------------|---------------|
| 14987 | 21 x 20 | 55,5 | 4,5 | | Buche / beech |



Besteckbehälter „BRIDGE“

cutlery organizer
cajón para cubiertos
bac à couverts



2 teiliges Set: 1 Gestell, 1 Besteckbehälter (Nr. 11955), herausnehmbar

2 pcs.: 1 base element, 1 removable plastic container (item 11955)

set de 2: 1 soporte, 1 cajón para cubiertos (ref. 11955) extraíble

set de 2: 1 support, 1 bac à couverts (réf. 11955) amovible

| | cm | ↑ cm | Farbe / Colour | |
|-------|-----------|------|----------------|---------------|
| 13995 | 57,5 x 37 | 12 | | Ahorn / maple |



Besteckbehälter „BRIDGE“

cutlery organizer
cajón para cubiertos
bac à couverts



2 teiliges Set: 1 Gestell, 1 Besteckbehälter (Nr. 11955), herausnehmbar

2 pcs.: 1 base element, 1 removable plastic container (item 11955)

set de 2: 1 soporte, 1 cajón para cubiertos (ref. 11955) extraíble

set de 2: 1 support, 1 bac à couverts (réf. 11955) amovible

| | cm | ↑ cm | Farbe / Colour | |
|-------|-----------|------|----------------|---------------|
| 14995 | 57,7 x 37 | 12 | | Buche / beech |

SUPERBOX



Die stapelbaren Wendeböden lassen sich rutschfest stapeln und mit flachen GN Platten verbinden und einzeln nutzen. Individuell können Buffet-landschaften gebaut werden.

The stackable and non-slip reversible boxes can be connected to flat GN trays and can also be used individually. Different and individual buffet sceneries can be built up.

Las cajas girables y apilables son antideslizantes y se pueden conectar con bandejas planas GN o utilizar individualmente. Se pueden construir diferentes paisajes de buffet muy individuales.

Les boîtes de tournage empilables sont antiglissantes et peuvent être connectées avec des plateaux plats GN ou utilisées individuellement. Des paysages de buffet très personnalisés peuvent être construits.



GN 1/1 „SUPERBOX“



Akazienholz / acacia wood / madera de acacia / bois d'acacia

| | cm | ↑ cm | GN | Farbe / Colour |
|-------|-------------|------|-----|----------------|
| 11620 | 55,5 x 35,0 | 10,5 | 1/1 | |
| 11626 | 55,5 x 35,0 | 10,5 | 1/1 | |
| 11721 | 55,5 x 35,0 | 20,0 | 1/1 | |
| 11723 | 55,5 x 35,0 | 20,0 | 1/1 | |



GN 2/4 „SUPERBOX“



Akazienholz / acacia wood / madera de acacia / bois d'acacia

| | cm | ↑ cm | GN | Farbe / Colour |
|-------|-------------|------|----|----------------|
| 11623 | 55,5 x 18,5 | 10,5 | | |
| 11629 | 55,5 x 18,5 | 10,5 | | |



GN 1/2 „SUPERBOX“



Akazienholz / acacia wood / madera de acacia / bois d'acacia

| | cm | ↑ cm | GN | Farbe / Colour |
|-------|-------------|------|-----|----------------|
| 11621 | 35,0 x 29,0 | 10,5 | 1/2 | |
| 11627 | 35,0 x 29,0 | 10,5 | 1/2 | |
| 11722 | 35,0 x 29,0 | 20,0 | 1/2 | |
| 11724 | 35,0 x 29,0 | 20,0 | 1/2 | |



GN 1/4 „SUPERBOX“

Akazienholz / acacia wood / mader de acacia / bois d'acacia



| | cm | ↑ cm | Farbe / Colour |
|-------|-----------|------|----------------|
| 11622 | 29 x 18,5 | 10,5 | |
| 11628 | 29 x 18,5 | 10,5 | |



GN „SUPERBOX VINTAGE“

Akazienholz
acacia wood
mader de acacia
bois d'acacia

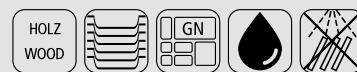

| | cm | ↑ cm | GN | Farbe / Colour |
|-------|-------------|------|-----|----------------|
| 11715 | 55,5 x 35,0 | 10,5 | 1/1 | |
| 11716 | 35,0 x 29,0 | 10,5 | 1/2 | |
| 11717 | 29,0 x 18,5 | 10,5 | 1/4 | |
| 11718 | 55,0 x 18,5 | 10,5 | 2/4 | |



Präsentationsmöglichkeiten
presentation examples



Buffetgestell

buffet stand
soporte para buffet
présentoir buffet



Metall, schwarz, passend für GN Boxen, mit Antrutschfüßchen
metal, black, suitable for GN boxes, with non-slip feet
metal, negro, apto para cajas GN, con pies antideslizantes
métal, noir, pour boîtes GN, avec pieds antidérapants

| | cm | ↑ cm | suitable for |
|-------|-----------|------|---------------------|
| 30331 | 49 x 38,5 | 48 | GN 1/1, GN1/2 boxes |



Präsentationsmöglichkeit
presentation example



GN Tablett „ZERO“

GN tray
GN bandeja
GN plateau



| | cm | ↑ cm | GN | Farbe / Colour |
|-------|-------------|------|-----|----------------|
| 84185 | 53,0 x 32,5 | 1,5 | 1/1 | _____ |
| 84186 | 32,5 x 26,5 | 1,5 | 1/2 | _____ |
| 84188 | 26,5 x 16,2 | 1,5 | 1/4 | _____ |
| 84189 | 53,0 x 16,2 | 1,5 | 2/4 | _____ |



mit Antirutschfüßchen
with non-slip feet



GN Naturschieferplatten

GN natural slate tray
GN bandeja de pizarra natural
GN plat ardoise naturelle



| | cm | GN |
|-------|-------------|-----|
| 00990 | 53,0 x 32,5 | 1/1 |
| 00991 | 32,5 x 26,5 | 1/2 |
| 00993 | 26,5 x 16,2 | 1/4 |
| 00973 | 53,0 x 16,2 | 2/4 |



GN Einsatz „SUPERBOX“

GN insert
GN bandeja
GN bac supérieur



| | cm | ↑ cm | GN | fits to |
|-------|-------------|------|-----|---------------------|
| 11616 | 53,0 x 32,5 | 8,5 | 1/1 | 11620, 11626, 11715 |
| 11617 | 32,5 x 26,5 | 8,5 | 1/2 | 11621, 11627, 11716 |



NEW **4 tlg. 4 pcs.**



11546



11075

Buche, wasserfest lackiert
beech wood lacquered



10791

Kühlakku halten Ihre Speisen bis zu 6 Stunden kühl
cooling system keeps the food cool for up to 6 hours

Buffetvitrine „TOP FRESH GN 1/1“
refrigerated buffet display
expositor buffet frío
plateau buffet froid



4-teilig: 1 Box aus Buchenholz mit Kunststoffwanne + 1 Edelstahl-Tablett GN 1/1 + 2 Kühlakkus, ohne Haube

4 pcs.: 1 beech wood box with plastic insert + 1 stainless steel tray GN 1/1 + 2 coolers, without cover

set de 4: 1 caja de madera de haya con bandeja de plástico + 1 bandeja de acero inoxidable GN 1/1 + 2 acumuladores de frío, sin campana

set de 4: 1 boîte en bois de hêtre avec bac en plastique + 1 plateau en acier inox GN 1/1 + 2 accumulateurs de froid, sans cloche

| | cm | ↑ cm |
|-------|---------|------|
| 11546 | 60 x 41 | 5 |

GN Rolltophaube mit schwarzem Griff / GN rolltop cover with black handle / GN campana rolltop con mango negro / GN cloche rolltop avec poignée noir

| | cm | ↑ cm | GN |
|-------|-----------|------|-----|
| 11075 | 53 x 32,5 | 19 | 1/1 |

GN Rolltophaube mit Chromgriff / GN rolltop cover with chrome handle / GN campana rolltop con asa cromada / GN cloche rolltop avec poignée chromée

| | cm | ↑ cm | GN |
|-------|-----------|------|-----|
| 11010 | 53 x 32,5 | 19 | 1/1 |

Kühlakku / cooler / acumulador de frío / accumulateur de froid

| | cm | ↑ cm |
|-------|---------|------|
| 10791 | 25 x 19 | 2,5 |

NEW **12 tlg. 12 pcs.**



11547

Buche, wasserfest lackiert
beech wood lacquered



10791

Kühlakku halten Ihre Speisen bis zu 6 Stunden kühl
cooling system keeps the food cool for up to 6 hours

Buffetvitrine „DOPPELDECKER GN 1/1“
refrigerated buffet display
expositor buffet frío
plateau buffet froid



12-teilig: 2 Boxen aus Buchenholz mit Kunststoffwanne + 2 Edelstahl-Tabletts GN 1/1 + 4 Kühlakkus + 4 verchromte Stangen, ohne Hauben

12 pcs.: 2 beech wood boxes with plastic insert + 2 stainless steel trays GN 1/1 + 4 coolers + 4 chrome-plated bars, without covers

set de 12: 2 cajas de madera de haya con bandeja de plástico + 2 bandejas de acero inoxidable GN 1/1 + 4 acumuladores de frío + 4 barras cromadas, sin campanas

set de 12: 2 boîtes en bois de hêtre avec bac en plastique + 2 plateaux en acier inox GN 1/1 + 4 accumulateurs de froid + 4 barres chromées, sans cloches

| | cm | ↑ cm |
|-------|---------|------|
| 11547 | 60 x 41 | 36 |

GN Rolltophaube mit schwarzem Griff / GN rolltop cover with black handle / GN campana rolltop con asa negra / GN cloche rolltop avec poignée noir

| | cm | ↑ cm | GN |
|-------|-----------|------|-----|
| 11075 | 53 x 32,5 | 19 | 1/1 |

GN Rolltophaube mit Chromgriff / GN rolltop cover with chrome handle / GN campana rolltop con asa cromada / GN cloche rolltop avec poignée chromée

| | cm | ↑ cm | GN |
|-------|-----------|------|-----|
| 11010 | 53 x 32,5 | 19 | 1/1 |

Kühlakku / cooler / acumulador de frío / accumulateur de froid

| | cm | ↑ cm |
|-------|---------|------|
| 10791 | 25 x 19 | 2,5 |

COOLING DISPLAYS

4 tlg.
4 pcs.



11540



11010

Buche, wasserfest lackiert
beech wood lacquered



10791

Kühlakkus halten Ihre Speisen bis zu 6 Stunden kühl
cooling system keeps the food cool for up to 6 hours

Buffetvitrine „TOP FRESH GN 1/1“

refrigerated buffet display
expositor buffet frío
plateau buffet froid



4-teilig: 1 Box aus Buchenholz mit Kunststoffwanne + 1 Edelstahl-Tablett GN 1/1 + 2 Kühlakkus, ohne Haube

4 pcs.: 1 beech wood box with plastic insert + 1 stainless steel tray GN 1/1 + 2 coolers, without cover

set de 4: 1 caja de madera de haya con bandeja de plástico + 1 bandeja de acero inoxidable GN 1/1 + 2 acumuladores de frío, sin campana

set de 4: 1 boîte en bois de hêtre avec bac en plastique + 1 plateau en acier inox GN 1/1 + 2 accumulateurs de froid, sans cloche

| | cm | ↑ cm |
|-------|---------|------|
| 11540 | 60 x 41 | 5 |

GN Rolltophaube mit Goldgriff / GN rolltop cover with gold handle / GN campana rolltop con asa dorada / GN cloche rolltop avec poignée en or

| | cm | ↑ cm | GN |
|-------|-----------|------|-----|
| 11008 | 53 x 32,5 | 19 | 1/1 |

GN Rolltophaube mit Chromgriff / GN rolltop cover with chrome handle / GN campana rolltop con asa cromada / GN cloche rolltop avec poignée chromée

| | cm | ↑ cm | GN |
|-------|-----------|------|-----|
| 11010 | 53 x 32,5 | 19 | 1/1 |

Kühlakku / cooler / acumulador de frío / accumulateur de froid

| | cm | ↑ cm |
|-------|---------|------|
| 10791 | 25 x 19 | 2,5 |

12 tlg.
12 pcs.



11541

Buche, wasserfest lackiert
beech wood lacquered



10791

Kühlakkus halten Ihre Speisen bis zu 6 Stunden kühl
cooling system keeps the food cool for up to 6 hours

Buffetvitrine „DOPPELDECKER GN 1/1“

cooling buffet display
expositor buffet frío
vitrine buffet



12-teilig: 2 Boxen aus Buchenholz mit Kunststoffwanne + 2 Edelstahl-Tabletts GN 1/1 + 4 Kühlakkus + 4 verchromte Stangen, ohne Hauben

12 pcs.: 2 beech wood boxes with plastic insert + 2 stainless steel trays GN 1/1 + 4 coolers + 4 chrome-plated bars, without covers

set de 12: 2 cajas de madera de haya con bandeja de plástico + 2 bandejas de acero inoxidable GN 1/1 + 4 acumuladores de frío + 4 barras cromadas, sin campanas

set de 12: 2 boîtes en bois de hêtre avec bac en plastique + 2 plateaux en acier inox GN 1/1 + 4 accumulateurs de froid + 4 barres chromées, sans cloches

| | cm | ↑ cm |
|-------|---------|------|
| 11541 | 60 x 41 | 36 |

GN Rolltophaube mit Goldgriff / GN rolltop cover with gold handle / GN campana rolltop con asa dorada / GN cloche rolltop avec poignée en or

| | cm | ↑ cm | GN |
|-------|-----------|------|----------------|
| 11008 | 53 x 32,5 | 19 | 1/1 Gold-Griff |

GN Rolltophaube mit Chromgriff / GN rolltop cover with chrome handle / GN campana rolltop con asa cromada / GN cloche rolltop avec poignée chromée

| | cm | ↑ cm | GN |
|-------|-----------|------|-----------------|
| 11010 | 53 x 32,5 | 19 | 1/1 Chrom-Griff |

Kühlakku / cooler / acumulador de frío / accumulateur de froid

| | cm | ↑ cm |
|-------|---------|------|
| 10791 | 25 x 19 | 2,5 |



3 tlg.
3 pcs.

11542

Buche, wasserfest lackiert
beech wood lacquered

18388

11542

10791

Kühlakku halten Ihre Speisen bis zu 6 Stunden kühl
cooling system keeps the food cool for up to 6 hours

Kühltablett „TOP FRESH RUND“

refrigerated buffet display
expositor buffet frío redondo
présentoir buffet



3-teilig: 1 Box aus Buchenholz mit Kunststoffwanne + 1 Edelstahl-Tablett Ø 38 cm + 1 Kühlakku, ohne Haube

3 pcs.: 1 beech wood box with plastic insert + 1 stainless tray Ø 38 cm + 1 cooler, without cover

set de 3: 1 caja de madera de haya con bandeja de plástico + 1 bandeja de acero inoxidable Ø 38 cm + 1 acumulador de frío, sin campana

set de 3: 1 boîte en bois de hêtre avec bac en plastique + 1 plateau en acier inox Ø 38 cm + 1 accumulateur de froid, sans cloche

| | Ø cm | ↑ cm |
|-------|------|------|
| 11542 | 48 | 6 |

Rolltophaube mit verchromtem Kugelgriff / rolltop cover with chrome-plated ball handle / campana abatible con asa de bola cromada / cloche basculante avec poignée boule chromée

| | Ø cm | ↑ cm |
|-------|------|------|
| 18388 | 38 | 20 |

Rolltophaube mit vergoldetem Kugelgriff / rolltop cover with gold-plated ball handle / campana abatible con asa de bola dorada / cloche basculante avec poignée boule plaquée or

| | Ø cm | ↑ cm |
|-------|------|------|
| 18387 | 38 | 20 |

Kühlakku / cooler / acumulador de frío / accumulateur de froid

| | cm | ↑ cm |
|-------|---------|------|
| 10791 | 25 x 19 | 2,5 |



11 tlg.
11 pcs.

18388

11543

Buche, wasserfest lackiert
beech wood lacquered

18388

11543

10791

Kühlakku halten Ihre Speisen bis zu 6 Stunden kühl
cooling system keeps the food cool for up to 6 hours

Buffetvitrine „DOPPELDECKER“

double refrigerated buffet display
expositor de buffet redondo doble
présentoir buffet froid, double



11-teilig: 2 Boxen aus Buchenholz mit Kunststoffwanne + 2 Edelstahl-Tablets Ø 38 cm + 2 Kühlakku + 2 Kunststoffschalen + 3 verchromte Stangen, ohne Hauben

11 pcs.: 2 beech wood boxes with plastic tray + 2 stainless steel trays Ø 38 cm, 2 coolers + 3 chrome-plated bars, without covers

set de 11: 2 cajas de madera de haya con bandeja de plástico + 2 bandejas de acero inoxidable Ø 38 cm + 2 acumuladores de frío + 2 bandejas de plástico + 3 barras cromadas, sin campanas

set de 11: 2 boîtes en bois de hêtre avec bac en plastique + 2 plateaux en inox Ø 38 cm + 2 accumulateurs de froid + 2 plateaux en plastique + 3 barres chromées, sans cloches

| | Ø cm | ↑ cm |
|-------|------|------|
| 11543 | 48 | 38 |

Rolltophaube mit verchromtem Kugelgriff / rolltop cover with chrome-plated ball handle / campana abatible con asa de bola cromada / cloche basculante avec poignée boule chromée

| | Ø cm | ↑ cm |
|-------|------|------|
| 18388 | 38 | 20 |

Rolltophaube mit vergoldetem Kugelgriff / rolltop cover with gold-plated ball handle / campana abatible con asa de bola dorada / cloche basculante avec poignée boule plaquée or

| | Ø cm | ↑ cm |
|-------|------|------|
| 18387 | 38 | 20 |

Kühlakku / cooler / acumulador de frío / accumulateur de froid

| | cm | ↑ cm |
|-------|---------|------|
| 10791 | 25 x 19 | 2,5 |

COOLING DISPLAYS



Kühlbox „SLATE“ refrigerated buffet display expositor buffet frío plateau buffet froid



3-teilig, bestehend aus: 1 Basis aus schwarzem Polystyrol,
1 Naturschieferplatte, 1 Kühlakku (ohne Haube)

3 pcs., set consists of: 1 base made of black polystyrene, 1 natural slate tray, 1 cooler (without cover)

set de 3 compuesto por: 1 soporte de poliestireno negro, 1 bandeja de pizarra natural, 1 acumulador de frío (sin campana)

set de 3 composé de: 1 support en polystyrène noir, 1 plateau en ardoise naturelle, 1 accumulateur de froid (sans couvercle)

| | cm | ↑ cm |
|-------|---------|------|
| 11645 | 58 x 38 | 6,5 |

Naturschieferplatte / natural slate tray / bandeja de pizarra natural / plateau ardoise naturelle

| | cm | * mm |
|--------------------------|---------|-------|
| 00979 <small>NEW</small> | 58 x 38 | 6 - 9 |

Kühlakku / cooler / acumulador de frío / accumulateur de froid

| | cm | ↑ cm |
|-------|---------|------|
| 10782 | 41 x 21 | 2,5 |

GN Rolltophaube mit schwarzem Griff / GN rolltop cover with black handle / GN campana rolltop con mango negro / GN cloche rolltop avec poignée noire

| | cm | ↑ cm | GN |
|--------------------------|-----------|------|-----|
| 11075 <small>NEW</small> | 53 x 32,5 | 19 | 1/1 |



Buffetvitrine „TOP FRESH GN 1/1“ cooling buffet display expositor buffet frío présentoir buffet



5-teilig: 1 Edelstahl-Tablett GN 1/1 + 2 Kühlakkus + 1 Edelstahl-Schale + 1 Acrylrahmen, ohne Haube

5 pcs.: 1 stainless steel tray GN 1/1 + 2 coolers + 1 stainless steel tray + 1 acrylic frame, without cover

set de 5: 1 bandeja de acero inoxidable GN 1/1 + 2 acumuladores de frío + 1 bandeja de acero inoxidable, 1 marco acrílico, sin campana

set de 5: 1 plateau en acier inox GN 1/1 + 2 accumulateurs de froid + 1 plateau inox - 1 cadre acrylique, sans cloche

| | cm | ↑ cm |
|-------|---------|------|
| 11510 | 61 x 38 | 8 |

Buffetvitrine „DOPPELDECKER GN1/1“ cooling buffet display expositor buffet frío présentoir buffet



14-teilig: 2 Edelstahl-Tablets GN 1/1 + 4 Kühlakkus + 2 Edelstahl-Schale + 2 Acrylrahmen + 4 verchromte Stangen, ohne Hauben

14 pcs.: 2 stainless steel trays GN 1/1 + 4 coolers + 2 stainless steel trays, 2 acrylic frame + 4 chrome-plated bars, without covers

set de 14: 2 bandejas de acero inoxidable GN 1/1 + 4 acumuladores de frío + 2 bandejas de acero inoxidable + 2 marcos acrílicos, 4 barras cromadas, sin campana

set de 14: 2 plateaux en acier inox GN 1/1 + 4 accumulateurs de froid, 2 bacs en acier inox + 2 cadres en acrylique + 4 barres chromées, sans cloches

| | cm | ↑ cm |
|-------|---------|------|
| 11514 | 61 x 38 | 33 |

GN Rolltophaube / GN rolltop cover / GN campana rolltop / GN cloche rolltop

| | cm | ↑ cm | GN |
|-------|-----------|------|-----|
| 11010 | 53 x 32,5 | 19 | 1/1 |

Kühlakku / cooler / acumulador de frío / accumulateur de froid

| | cm | ↑ cm |
|-------|---------|------|
| 10791 | 25 x 19 | 2,5 |



Kühlatablett „TOP FRESH RUND“

cooling plate
expositor buffet frío
présentoir buffet



4-teilig: 1 Edelstahl-Tablett Ø 38 cm + 2 Kühlakkus + 1 Edelstahl-Schale + 1 Acrylrahmen, ohne Haube

4 pcs.: 1 stainless steel tray Ø 38 cm + 2 coolers + 1 stainless steel tray + 1 acrylic frame, without cover

set de 4: 1 bandeja de acero inox Ø 38 cm + 2 acumuladores de frío + 1 bandeja de acero inox + 1 marco acrílico, sin campana

set de 4: 1 plateau en acier inox Ø 38 cm + 2 accumulateurs de froid + 1 cadre acrylique, sans cloche

| | Ø cm | ↑ cm |
|-------|------|------|
| 11512 | 43,5 | 5,5 |

Rolltophaube mit verchromtem Kugelgriff / rolltop cover with chrome-plated ball handle / campana abatible con asa de bola cromada / cloche basculante avec poignée boule chromée

| | Ø cm | ↑ cm | |
|-------|------|------|----------------------------|
| 18388 | 38 | 20 | mit verchromtem Kugelgriff |

Kühlakku / cooler / acumulador de frío / accumulateur de froid

| | cm | ↑ cm | pcs. |
|-------|----------|------|------|
| 11101 | 16 x 7,5 | 2 | 4 |



Kühlbox „TOP FRESH GN 1/1“

cooling plate
bandeja de frío
présentoir buffet réfrigéré



4-teilig: 1 Kühlbox + 1 Tablett GN 1/1 + 2 Kühlakkus, ohne Haube

4 pcs.: 1 box + 1 tray GN 1/1 + 2 coolers, without cover

set de 4: 1 caja + 1 bandeja GN 1/1 + 2 acumuladores de frío, sin campana

set de 4: 1 caisson + 1 plateau GN 1/1 + 2 accumulateurs de froid, sans cloche

| | cm | ↑ cm | Farbe / Colour |
|-------|-----------|------|----------------|
| 11503 | 56,5 x 35 | 6,5 | White |
| 11505 | 56,5 x 35 | 6,5 | Black |

GN Rolltophaube mit vergoldetem Kreuzgriff / GN rolltop cover with gold-plated cross handle / GN campana rolltop con asa en cruz dorada / GN cloche rolltop avec manche en croix plaqué or

| | cm | ↑ cm | GN | |
|-------|-------------|------|-----|----------------------------|
| 11008 | 53,0 x 32,5 | 19 | 1/1 | mit vergoldetem Kreuzgriff |

GN Rolltophaube mit verchromtem Kreuzgriff / GN rolltop cover with chrome-plated cross handle / GN campana rolltop con asa en cruz cromada / GN cloche rolltop avec manche en croix chromée

| | cm | ↑ cm | GN | |
|-------|-----------|------|-----|----------------------------|
| 11010 | 53 x 32,5 | 19 | 1/1 | mit verchromtem Kreuzgriff |

Kühlakku / cooler / acumulador de frío / accumulateur de froid

| | cm | ↑ cm |
|-------|---------|------|
| 10791 | 25 x 19 | 2,5 |

GN Edelstahl-Tablett „PROFI LINE“ / GN tray / GN bandeja / GN plateau

| | cm | ↑ cm | GN |
|-------|-----------|------|-----|
| 11100 | 53 x 32,5 | 1,5 | 1/1 |

COOLING DISPLAYS



18388

Kühlplatte
bandeja de frío
set frigorifère

3-teilig: 1 Box + 1 Tablett Ø 38 cm + 1 Kühlakku, ohne Haube
3 pcs.: 1 box + 1 tray Ø 38 cm + 1 cooler, without cover
set de 3: 1 caja + 1 bandeja Ø 38 cm + 1 acumulador de frío, sin campana
set de 3: 1 caisson + 1 plateau Ø 38 cm + 1 accumulateur de froid, sans cloche

| | Ø cm | ↑ cm | Farbe / Colour |
|-------|------|------|----------------|
| 11538 | 42 | 6 | White |
| 11533 | 42 | 6 | Black |



11538

10791

Kühlakku halten Ihre Speisen
bis zu 6 Stunden kühl
cooling system keeps the food
cool for up to 6 hours

Kühlbox „TOP FRESH SET“

cooling plate
bandeja de frío
set frigorifère

ACRYL ACRYLIC

EDELSTAHL STAINLESS INOX 18/0

Made in Germany

3-teilig: 1 Box + 1 Tablett Ø 38 cm + 1 Kühlakku, ohne Haube
3 pcs.: 1 box + 1 tray Ø 38 cm + 1 cooler, without cover
set de 3: 1 caja + 1 bandeja Ø 38 cm + 1 acumulador de frío, sin campana
set de 3: 1 caisson + 1 plateau Ø 38 cm + 1 accumulateur de froid, sans cloche

| | Ø cm | ↑ cm | Farbe / Colour |
|-------|------|------|----------------|
| 11538 | 42 | 6 | White |
| 11533 | 42 | 6 | Black |

Rolltophaube mit verchromtem Kugelgriff / rolltop cover with chrome-plated ball handle / campana abatible con asa de bola cromada / cloche basculante avec poignée boule chromée

| | Ø cm | ↑ cm |
|-------|------|------|
| 18388 | 38 | 20 |

Kühlakku / cooler / acumulador de frío / accumulateur de froid

| | cm | ↑ cm |
|-------|---------|------|
| 10791 | 25 x 19 | 2,5 |



18388

thermo set
bandeja isotérmica
set thermo

5-teilig: 1 Tablett tief + 1 Tablett flach + 2 Kühlakkus + 1 Rolltophaube
5 pcs.: 1 deep tray + 1 tray + 2 cooler + 1 rolltop cover
set de 5: 1 bandeja honda + 1 bandeja plana + 2 acumuladores frío + 1 campana rolltop
set de 5: 1 plateau creux + 1 plateau plat + 2 accumulateurs de froid + 1 cloche rolltop

| | Ø cm | ↑ cm |
|-------|------|------|
| 09082 | 38 | 24 |



11101

Kühlakkus halten Ihre Speisen
bis zu 6 Stunden kühl
cooling system keeps the food
cool for up to 6 hours

Thermo-Set

thermo set
bandeja isotérmica
set thermo

SAN KUNSTSTOFF

EDELSTAHL STAINLESS INOX 18/0

Made in Germany

5-teilig: 1 Tablett tief + 1 Tablett flach + 2 Kühlakkus + 1 Rolltophaube
5 pcs.: 1 deep tray + 1 tray + 2 cooler + 1 rolltop cover
set de 5: 1 bandeja honda + 1 bandeja plana + 2 acumuladores frío + 1 campana rolltop
set de 5: 1 plateau creux + 1 plateau plat + 2 accumulateurs de froid + 1 cloche rolltop

| | Ø cm | ↑ cm |
|-------|------|------|
| 09082 | 38 | 24 |

Rolltophaube mit verchromtem Kugelgriff / rolltop cover with chrome-plated ball handle / campana abatible con asa de bola cromada / cloche basculante avec poignée boule chromée

| | Ø cm | ↑ cm |
|-------|------|------|
| 18388 | 38 | 20 |

Kühlakku / cooler / acumulador de frío / accumulateur de froid

| | cm | ↑ cm | pcs. |
|-------|----------|------|------|
| 11101 | 16 x 7,5 | 2 | 4 |



4 tlg.
4 pcs.

09083

thermo set
porta tartas refrigerado
porte-gâteau réfrigéré

4-teilig: 1 Tablett tief auf Fuß + 1 Tablett flach + 2 Kühlakkus
4 pcs.: 1 deep tray with feet + 1 tray + 2 coolers
set de 4: 1 bandeja honda con pie + 1 bandeja plana + 2 acumuladores de frío
set de 4: 1 plateau creux avec pied + 1 plateau plat + 2 accumulateurs de froid

| | Ø cm | ↑ cm |
|-------|------|------|
| 09083 | 38 | 14,5 |



11101

Kühlakkus halten Ihre Speisen
bis zu 6 Stunden kühl
cooling system keeps the food
cool for up to 6 hours

Thermo-Set

thermo set
porta tartas refrigerado
porte-gâteau réfrigéré

EDELSTAHL STAINLESS INOX 18/8

Made in Germany

4-teilig: 1 Tablett tief auf Fuß + 1 Tablett flach + 2 Kühlakkus
4 pcs.: 1 deep tray with feet + 1 tray + 2 coolers
set de 4: 1 bandeja honda con pie + 1 bandeja plana + 2 acumuladores de frío
set de 4: 1 plateau creux avec pied + 1 plateau plat + 2 accumulateurs de froid

| | Ø cm | ↑ cm |
|-------|------|------|
| 09083 | 38 | 14,5 |

Rolltophaube mit verchromtem Kugelgriff / rolltop cover with chrome-plated ball handle / campana abatible con asa de bola cromada / cloche basculante avec poignée boule chromée

| | Ø cm | ↑ cm |
|-------|------|------|
| 18388 | 38 | 20 |

Kühlakku / cooler / acumulador de frío / accumulateur de froid

| | cm | ↑ cm | pcs. |
|-------|----------|------|------|
| 11101 | 16 x 7,5 | 2 | 4 |



4 tlg.
4 pcs.

9 cm

11812 0,6 ltr.



11,5 cm

11813 1 ltr.



10661

Kühlakkus halten Ihre Speisen bis zu 6 Stunden kühl
cooling system keeps the food cool for up to 6 hours

Kühlschale Mini Holz „TOP FRESH“

cool bowl mini holz
bol refrigerado mini madera
bol réfrigéré mini bois



4-teilig: 1 Fuß Buchenholz versiegelt + 1 Schale + 1 Kühlakku + 1 klappbarer Deckel mit Beschriftungsschild

4 pcs.: 1 foot beech wood + 1 bowl + 1 cooler + 1 hinged cover with label
set de 4: 1 base de madera de haya + 1 cuenco + 1 acumulador de frío + 1 tapa abatible con etiqueta

set de 4: 1 pied en hêtre + 1 bac + 1 accumulateur de froid + 1 couvercle à charnière avec étiquette

| | Ø cm | ↑ cm | ltr. |
|-------|------|------|------|
| 11812 | 14 | 9,0 | 0,6 |
| 11813 | 14 | 11,5 | 1,0 |

Ersatzschale / spare bowl / cuenco de recambio / bol de rechange

| | Ø cm | ↑ cm |
|-------|------|------|
| 11811 | 14 | 6,5 |
| 11816 | 14 | 9,0 |

Schutzdeckel mit Löffelaussparung / cover / tapa / couvercle

| | Ø cm |
|-------|------|
| 11868 | 14,5 |

Kühlakku / cooler / acumulador de frío / accumulateur de froid

| | Ø cm | ↑ cm |
|-------|------|------|
| 10661 | 10,5 | 2 |



4 tlg.
4 pcs.

14 cm

11817
2,5 ltr.



18 cm

11818
4 ltr.

Kühlschale Maxi Holz „TOP FRESH“

cool bowl maxi holz
bol refrigerado maxi madera
bol réfrigéré maxi bois



4-teilig: 1 Fuß Buchenholz versiegelt + 1 Schale + 1 Kühlakku + 1 klappbarer Deckel mit Beschriftungsschild

4 pcs.: 1 foot beech wood + 1 bowl + 1 cooler + 1 hinged cover with label
set de 4: 1 base de madera de haya + 1 cuenco + 1 acumulador de frío + 1 tapa abatible con etiqueta

set de 4: 1 pied en hêtre + 1 bac + 1 accumulateur de froid + 1 couvercle à charnière avec étiquette

| | Ø cm | ↑ cm | ltr. |
|-------|------|------|------|
| 11817 | 22 | 14 | 2,5 |
| 11818 | 22 | 18 | 4,0 |

Ersatzschale / spare bowl / cuenco de recambio / bol de rechange

| | Ø cm | ↑ cm |
|-------|------|------|
| 11846 | 22 | 8 |
| 11848 | 22 | 12 |

Schutzdeckel mit Löffelaussparung / cover / tapa / couvercle

| | Ø cm |
|-------|------|
| 11878 | 23,5 |

Kühlakku / cooler / acumulador de frío / accumulateur de froid

| | Ø cm | ↑ cm |
|-------|------|------|
| 10777 | 15 | 2,5 |

COOLING DISPLAYS

4 tlg.
4 pcs.



9 cm

11812 0,6 ltr.



11,5 cm

11815 1 ltr.



10661

Kühlakkus halten Ihre Speisen bis zu 6 Stunden kühl
cooling system keeps the food cool for up to 6 hours

Kühlschale Mini „TOP FRESH“

cool bowl mini
bol refrigerado mini
bol réfrigéré mini



4-teilig: 1 Edelstahlgefäß matt + 1 Kühlakku + 1 Schale + 1 klappbarer Deckel mit Beschriftungsschild

4 pcs.: 1 stainless steel bowl matt + 1 bowl + 1 cooler + 1 hinged cover with label

set de 4: 1 recipiente de acero inoxidable mate + 1 cuenco + 1 acumulador de frío + 1 tapa abatible con etiqueta

set de 4: 1 récipient en acier inox mat + 1 bac + 1 accumulateur de froid + 1 couvercle à charnière avec étiquette

| | Ø cm | ↑ cm | ltr. |
|-------|------|------|------|
| 11810 | 14 | 9,0 | 0,6 |
| 11815 | 14 | 11,5 | 1,0 |

Ersatzschale / spare bowl / cuenco de recambio / bol de rechange

| | Ø cm | ↑ cm |
|-------|------|------|
| 11811 | 14 | 6,5 |
| 11816 | 14 | 9,0 |

Schutzdeckel mit Löffelaussparung / cover / tapa / couvercle

| | Ø cm |
|-------|------|
| 11868 | 14,5 |

Kühlakku / cooler / acumulador de frío / accumulateur de froid

| | Ø cm | ↑ cm |
|-------|------|------|
| 10661 | 10,5 | 2 |

4 tlg.
4 pcs.



14 cm

11847 2,5 ltr.



18 cm

11849 4 ltr.

Kühlschale Maxi „TOP FRESH“

cool bowl maxi
bol refrigerado maxi
bol réfrigéré maxi



4-teilig: 1 Edelstahlgefäß hochglanzpoliert + 1 Kühlakku + 1 Schale + 1 klappbarer Deckel mit Beschriftungsschild

4 pcs.: 1 stainless steel bowl matt + 1 bowl + 1 cooler + 1 hinged cover with label

set de 4: 1 recipiente de acero inoxidable mate + 1 cuenco + 1 acumulador de frío + 1 tapa abatible con etiqueta

set de 4: 1 récipient en acier inox mat + 1 bac + 1 accumulateur de froid + 1 couvercle à charnière avec étiquette

| | Ø cm | ↑ cm | ltr. |
|-------|------|------|------|
| 11847 | 22 | 14 | 2,5 |
| 11849 | 22 | 18 | 4,0 |

Ersatzschale / spare bowl / cuenco de recambio / bol de rechange

| | Ø cm | ↑ cm |
|-------|------|------|
| 11846 | 22 | 8 |
| 11848 | 22 | 12 |

Schutzdeckel mit Löffelaussparung / cover / tapa / couvercle

| | Ø cm |
|-------|------|
| 11878 | 23,5 |

Kühlakku / cooler / acumulador de frío / accumulateur de froid

| | Ø cm | ↑ cm |
|-------|------|------|
| 10777 | 15 | 2,5 |

4 tlg.
4 pcs.



11845
2,5 ltr.



11875

Kühlschale Maxi „TOP FRESH“

cool bowl maxi
cuenco refrigerado maxi
bol réfrigéré maxi



4-teilig: 1 Gefäß hochglanzpoliert + 1 Kühlakku + 1 Glasschale + 1 klappbarer Deckel mit Beschriftungsschild

4 pcs.: 1 stainless steel bowl mirror polished + 1 cooler + 1 glass bowl + 1 hinged cover with label

set de 4: 1 recipiente de acero inoxidable pulido brillante + 1 acumulador de frío + 1 cuenco de vidrio + 1 tapa abatible con etiqueta

set de 4: 1 récipient en acier inox poli mat + 1 accumulateur de froid + 1 bol en verre + 1 couvercle à charnière avec étiquette

| | Ø cm | ↑ cm | ltr. |
|-------|------|------|------|
| 11845 | 23 | 14 | 2,5 |

Ersatzschale / spare bowl / cuenco de recambio / bol de rechange

| | Ø cm | ↑ cm | ltr. |
|-------|------|------|------|
| 11875 | 23 | 10,5 | 2,5 |

Schutzdeckel mit Löffelaussparung / cover / tapa / couvercle

| | Ø cm |
|-------|------|
| 11878 | 23,5 |

Kühlakku / cooler / acumulador de frío / accumulateur de froid

| | Ø cm | ↑ cm |
|-------|------|------|
| 10777 | 15 | 2,5 |

Schale „CASUAL MAXI“

bowl
cuenco
bol



83696



83705



83920

| | Ø cm | ↑ cm | ltr. | Farbe / Colour |
|-------|------|------|------|----------------|
| 83696 | 10 | 4,5 | 0,15 | White |
| 83698 | 12 | 5,5 | 0,25 | White |
| 83700 | 14 | 6,5 | 0,50 | White |
| 83704 | 20 | 9,2 | 1,80 | White |
| 83702 | 23 | 10,5 | 2,50 | White |

| | Ø cm | ↑ cm | ltr. | Farbe / Colour |
|-------|------|------|------|----------------|
| 83697 | 10 | 4,5 | 0,15 | Black |
| 83699 | 12 | 5,5 | 0,25 | Black |
| 83701 | 14 | 6,5 | 0,50 | Black |
| 83705 | 20 | 9,2 | 1,80 | Black |
| 83703 | 23 | 10,5 | 2,50 | Black |

Deckel „FLOAT“ mit Löffelaussparung / cover, with notched for spoons / tapa, con espacio para la cuchara / couvercle, avec encoche pour la louche

| | Ø cm | ↑ cm | fits to |
|-------|------|------|--------------|
| 83920 | 20,5 | 1,3 | 83704, 83705 |

COOLING DISPLAYS

09100

09102

90902

11101

Kühlakkus halten Ihre Speisen bis zu 6 Stunden kühl
cooling system keeps the food cool for up to 6 hours

Buffetvitrine showcase vitrina de buffet vitrine de buffet



5-teilig: 1 transparente Rolltophaube beidseitig aufklappbar + 1 Schale (ABS) + 1 Edelstahl-Tablett 39 x 28 cm + 2 Kühlakkus

5 pcs.: 1 transparent rolltop cover + 1 tray (ABS) + 1 stainless tray 39 x 28 cm + 2 coolers
set de 5: 1 tapa abatible, por ambos lados, transparente + 1 bandeja (ABS) + 1 bandeja de acero inoxidable 39 x 28 cm + 2 acumuladores de frío

set de 5: 1 cloche transparente ouverture 2 côtés + 1 caisson (ABS) + 1 plateau en acier inox 39 x 28 cm + 2 accumulateurs de froid

| | cm | ↑ cm | Farbe / Colour |
|-------|---------|------|----------------|
| 09100 | 44 x 32 | 20,5 | White |
| 09102 | 44 x 32 | 20,5 | Blue |
| 09104 | 44 x 32 | 20,5 | Black |

Kühlakku / cooler / acumulador de frío / accumulateur de froid

| | cm | ↑ cm | pcs. |
|-------|----------|------|------|
| 11101 | 16 x 7,5 | 2 | 4 |

Edelstahl-Tablett / stainless steel tray / bandeja de acero inoxidable / plateau inox

| | cm | ↑ cm |
|-------|-------------|------|
| 90902 | 39,5 x 28,5 | 1 |



Servierbeispiel
presentation example

09200

09202

09204

Buffetvitrine „DOPPELDECKER“ showcase vitrina de buffet, 2 alturas vitrine de buffet double



2 transparente Rolltophauben beidseitig aufklappbar + 2 Schalen (ABS) + 2 Edelstahl-Tabletts 39 x 28 cm + 4 Kühlakkus, platzsparend lagerbar

2 transparent rolltop cover + 2 trays (ABS) + 2 tray 39 x 28 cm + 4 coolers, space saving
2 campanas abatibles por ambos lados transparentes + 2 bandejas (ABS) + 2 bandejas de acero inoxidable 39 x 28 cm + 4 acumuladores de frío, almacenamiento en poco espacio

2 cloches transparentes abattantes 2 côtés + 2 caissons (ABS) + 2 plateaux en acier inox 39 x 28 cm + 4 accumulateurs de froid, peut encombrant à stocker

| | cm | ↑ cm | Farbe / Colour |
|-------|---------|------|----------------|
| 09200 | 44 x 32 | 44 | White |
| 09202 | 44 x 32 | 44 | Blue |
| 09204 | 44 x 32 | 44 | Black |

Kühlakku / cooler / acumulador de frío / accumulateur de froid

| | cm | ↑ cm | pcs. |
|-------|----------|------|------|
| 11101 | 16 x 7,5 | 2 | 4 |

Edelstahl-Tablett / stainless steel tray / bandeja de acero inoxidable / plateau inox

| | cm | ↑ cm |
|-------|-------------|------|
| 90902 | 39,5 x 28,5 | 1 |



6 tlg.
6 pcs.



Thermo Tablett-Set, 6-teilig

thermo tray, 6 pcs.
bandeja térmica, set de 6
plateau thermique, set de 6



- 6-teilig:
- 1 Schale
 - 1 Edelstahltablett
 - 2 Kühlakkus
 - 1 transparente Frischhaltehaube
 - 1 Transport- und Tragegurt aus Silikon

- 6 pcs.:
- 1 plastic tray
 - 1 stainless steel tray
 - 2 coolers
 - 1 transparent cover
 - 1 silicone transport and carrying strap

- set de 6:
- 1 bandeja de plástico
 - 1 bandeja de acero inoxidable
 - 2 acumuladores de frío
 - 1 campana transparente
 - 1 correa de silicona para cierre y transporte

- set de 6:
- 1 plateau plastique
 - 1 plateau en acier inox
 - 2 accumulateurs de froid
 - 1 cloche transparente
 - 1 sangle en silicone pour fermeture et transport

inklusive
Transport- und
Tragegurt!

| | cm | ↑ cm | Farbe / Colour |
|-------|---------|------|----------------|
| 09091 | 43 x 29 | 14 | |
| 09090 | 43 x 29 | 14 | |



inklusive 2 Kühlakkus
including 2 coolers



6 tlg.
6 pcs.



Thermo Tablett-Set, 6-teilig

thermo tray, 6 pcs.
bandeja térmica, set de 6
plateau thermique, set de 6



- 6-teilig:
- 1 Schale
 - 1 Edelstahltablett
 - 2 Kühlakkus
 - 1 transparente Frischhaltehaube
 - 1 Transport- und Tragegurt aus Silikon

- 6 pcs.:
- 1 plastic tray
 - 1 stainless steel tray
 - 2 coolers
 - 1 transparent cover
 - 1 silicone transport and carrying strap

- set de 6:
- 1 bandeja de plástico
 - 1 bandeja de acero inoxidable
 - 2 acumuladores de frío
 - 1 campana transparente
 - 1 correa de silicona para cierre y transporte

- set de 6:
- 1 plateau plastique
 - 1 plateau en acier inox
 - 2 accumulateurs de froid
 - 1 cloche transparente
 - 1 sangle en silicone pour fermeture et transport

inklusive
Transport- und
Tragegurt!

| | cm | ↑ cm | Farbe / Colour |
|-------|----|------|----------------|
| 09094 | 35 | 15 | |
| 09093 | 35 | 15 | |



inklusive 2 Kühlakkus
including 2 coolers



BEVERAGE DISPENSERS



NEW

7 ltr.

10853

Getränkespender „INDUSTRIAL“

beverage dispenser
dispensador de bebidas
distributeur de boissons

Black
is
beautiful

GLAS
GLASS

EDELSTAHL
STAINLESS
INOX

METALL

SILIKON
SILICON

NON
SLIP FEET

Behälter aus Glas, Zapfhahn aus Edelstahl, Fuß und Deckel aus Metall, schwarz, Antirutschmatte aus Silikon

glass container, stainless steel tap, base and lid in black metal, silicone non-slip mat
recipiente de vidrio, grifo de acero inoxidable, base y tapa de metal negro, alfombra antideslizante de silicona

réceptien en verre, robinet en acier inox, pied et couvercle en métal noir, tapis antidérapant en silicone

| | Ø cm | ↑ cm | ltr. | |
|-------|------|------|------|-----------------------------|
| 10450 | 20 | 45 | 7 | inkl. Gestell / incl. stand |



Antirutschmatte aus Silikon
Antirutschmatte aus Silikon



NEW

7 ltr.

Getränkespender „URBAN“

beverage dispenser
dispensador de bebidas
distributeur de boissons

Black
is
beautiful

GLAS
GLASS

EDELSTAHL
STAINLESS
INOX

METALL

SILIKON
SILICON

NON
SLIP FEET

Behälter aus Glas, Zapfhahn aus Edelstahl, Fuß und Deckel aus Metall, schwarz, Antirutschmatte aus Silikon

glass container, stainless steel tap, base and lid in black metal, silicone non-slip mat
recipiente de vidrio, grifo de acero inoxidable, base y tapa de metal negro, alfombra antideslizante de silicona

réceptien en verre, robinet en acier inox, pied et couvercle en métal noir, tapis antidérapant en silicone

| | Ø cm | ↑ cm | ltr. | |
|-------|------|------|------|-----------------------------|
| 10451 | 22 | 45 | 7 | inkl. Gestell / incl. stand |



Antirutschmatte aus Silikon
Antirutschmatte aus Silikon



Eiswasserröhre

ice cube cooling tube
tubo enfriador para cubitos
tube pour glaçons

PP
POLYPROPYLEN



| | Ø cm | ↑ cm | passend für Getränkenspender / fits to drink dispenser |
|-------|------|------|---|
| 10849 | 11 | 24 | 10400, 10403, 10450, 10451, 10855 |



7 ltr.

Getränkespender „ELEMENT“

beverage dispenser
dispensador de bebidas
distributeur de boissons



Behälter aus Glas, Zapfhahn aus Edelstahl, Fuß und Deckel aus Beton

glass container, stainless steel tap, stand and lid made of concrete
recipiente de vidrio, grifo de acero inoxidable, soporte y tapa de hormigón
récipient en verre, robinet en acier inox, support et couvercle en béton

| | Ø cm | ↑ cm | ltr. | |
|-------|------|------|------|-----------------------------|
| 10400 | 22 | 45 | 7 | inkl. Gestell / incl. stand |



7 ltr.

Getränkespender „ASIA“

beverage dispenser
dispensador de bebidas
distributeur de boissons



Behälter aus Glas, Zapfhahn aus Edelstahl, Fuß und Deckel aus Holz

glass container, stainless steel tap, wooden stand and lid
recipiente de vidrio, grifo de acero inoxidable, soporte y tapa de madera
récipient en verre, robinet en acier inox, support et couvercle en bois

| | Ø cm | ↑ cm | ltr. | |
|-------|------|------|------|-----------------------------|
| 10403 | 24,5 | 45,5 | 7 | inkl. Gestell / incl. stand |

Ersatz-Fuß / base / soporte de recambio / support de remplacement

| | Ø cm | ↑ cm | |
|-------|------|------|--|
| 10404 | 24,5 | 15 | |

Ersatz-Deckel / replacement lid / tapa de recambio / couvercle de rechange

| | Ø cm | ↑ cm | |
|-------|------|------|--|
| 10405 | 14,0 | 5 | |



7 ltr.

Getränkespender „OLD FASHIONED“

beverage dispenser
dispensador de bebidas
distributeur de boissons



Behälter aus Glas, Zapfhahn aus Edelstahl, Gestell schwarz

glass container, stainless steel tap, black stand
recipiente de vidrio, grifo de acero inoxidable, soporte negro
récipient en verre, robinet en acier inox, support noir

| | Ø cm | ↑ cm | ltr. | |
|-------|------|------|------|-----------------------------|
| 10409 | 27 | 50,5 | 7 | inkl. Gestell / incl. stand |

Ersatz-Gestell / stand / soporte de recambio / support de remplacement

| | Ø cm | ↑ cm | |
|-------|------|------|--|
| 10410 | 27 | 31,5 | |

Ersatz-Glas / replacement glass / cristal de recambio / vitre de rechange

| | Ø cm | ↑ cm | ltr. |
|-------|------|------|------|
| 10411 | 19 | 36,5 | 7 |

Ersatz-Zapfhahn 10409 / replacement tap for 10409

10718



10853

Tropfenschale, 2-teilig

drip tray, 2 pcs.
aros anti-goteo, set de 2
anneaux coupe-gouttes, set de 2



| | Ø cm | ↑ cm | Farbe / Colour |
|-------|------|------|----------------|
| 10851 | 9,5 | 1,5 | White |
| 10853 | 9,5 | 1,5 | Black |

BEVERAGE DISPENSERS



Getränkespender

beverage dispenser
dispensador de bebidas
distributeur de boissons



Behälter aus Glas, Zapfhahn aus Edelstahl, Deckel aus Edelstahl

glass container, stainless steel tap, lid in stainless steel
recipiente de vidrio, grifo de acero inoxidable, tapa de acero inoxidable
récipient en verre, robinet en acier inox, couvercle en acier inox

| | Ø cm | ↑ cm | ltr. |
|-------|------|------|------|
| 10855 | 20 | 30,5 | 7 |



Getränkespender „FRUITS“

beverage dispenser
dispensador de bebidas
distributeur de boissons



Behälter aus Glas, Zapfhahn aus Edelstahl, Gestell schwarz

glass container, stainless steel tap, black stand
recipiente de vidrio, grifo de acero inoxidable, soporte negro
récipient en verre, robinet en acier inox, support noir

| | Ø cm | ↑ cm | ltr. | |
|-------|------|------|------|-----------------------------|
| 10415 | 25 | 58 | 10,5 | inkl. Gestell / incl. stand |

Trinkglas „BEACH“

drinking glass / vaso / verre



| | Ø cm | ↑ cm | ltr. | VE |
|-------|------|------|------|----|
| 10505 | 8,5 | 13,5 | 0,3 | 48 |

Ersatzteile Getränkspender „FRUITS“

spare parts beverage dispenser
recambios dispensador de bebidas
pièces distributeur de boissons



Ersatz-Deckel / replacement glass / cristal de recambio / vitre de rechange

| | Ø cm | ↑ cm |
|-------|------|------|
| 10418 | 14 | 12 |

Ersatz-Glas inklusive Deckel, ohne Zapfhahn / replacement glass with lid without tap / cristal de recambio con tapa sin grifo / vitre de rechange avec couvercle sans robinet

| | Ø cm | ↑ cm | ltr. |
|-------|------|------|------|
| 10417 | 25 | 42 | 10,5 |

Ersatz-Zapfhahn / replacement tap / grifo de recambio / robinet de rechange



| | | |
|-------|--|--|
| 10718 | | |
|-------|--|--|

Ersatz-Gestell / stand / soporte de recambio / support de remplacement



| | Ø cm | ↑ cm |
|-------|------|------|
| 10416 | 26 | 19 |



4,5 ltr.

300 ml



4,5 ltr.

Getränkespender „FRESH WOOD“

beverage dispenser
dispensador de bebidas
distributeur de boissons



Behälter mit Edelstahlzapfhahn und Korkdeckel, stabiles Glas, inklusive Holzstandfuß und Kork-Untersetzer

container with stainless steel tap and cork cover, solid glas, including wooden base and cork coaster

recipiente con grifo de acero inoxidable y tapa de corcho, cristal sólido, pie de madera y posavasos de corcho

réipient avec robinet en acier inox et covercle de liège, verre robuste, pied en bois et soucoupes de liège

| | cm | ↑ cm | ltr. |
|-------|---------|------|------|
| 10430 | 23 x 23 | 56,5 | 4,5 |

Trinkbecher „CRYSTAL“
drinking cup / vaso / gobelet



| | Ø cm | ↑ cm | ltr. | VE |
|-------|------|------|------|----|
| 10501 | 8 | 12,5 | 0,3 | 48 |

Tropfenschale / drip tray / aro anti-goteo / anneau coupe-gouttes



| | Ø cm | ↑ cm | Farbe / Colour |
|-------|------|------|----------------|
| 10851 | 9,5 | 1,5 | White |

Ersatzteile Getränkspender „FRESH WOOD“

spare parts beverage dispenser
recambios dispensador de bebidas
pièces distributeur de boissons

Ersatz-Deckel / replacement lid / tapa de recambio / couvercle de rechange

| | Ø cm | ↑ cm | Farbe / Colour |
|-------|------|------|----------------|
| 10428 | 11,5 | 1,5 | Light Brown |

Ersatz-Glas inklusive Zapfhahn / replacement glass with tap / cristal de recambio con grifo / vitre de rechange avec robinet

| | Ø cm | ↑ cm | ltr. |
|-------|------|------|------|
| 10422 | 15,5 | 42,0 | 4,5 |

Ersatz-Untersetzer aus Kork / replacement cork coaster / posavasos de corcho de recambio / soucoupes de liège de rechange

| | Ø cm | ↑ cm |
|-------|------|------|
| 10424 | 16,5 | 1,5 |

Ersatz-Gestell / stand for / soporte de recambio / support de remplacement

| | cm | ↑ cm | Farbe / Colour |
|-------|---------|------|----------------|
| 10426 | 23 x 23 | 14 | Light Brown |

BEVERAGE DISPENSERS



Getränkespender „NORDIC WOOD“

beverage dispenser
dispensador de bebidas
distributeur de boissons



Behälter mit Edelstahlzapfhahn und Holzdeckel, stabiles Glas, inklusive weißem Holzstandfuß und Kork-Untersetzer

container with stainless steel tap and wooden cover, solid glas, including white wooden base and cork coaster

recipiente con grifo de acero inoxidable y tapa de madera, cristal sólido, pie de madera blanca y posavasos de corcho

réipient avec robinet en acier inox et covercle en bois, verre robuste, pied en bois blanc et soucoupes de liège

| | cm | ↑ cm | ltr. |
|-------|---------|------|------|
| 10435 | 23 x 23 | 60,5 | 7,5 |

Trinkbecher „CRYSTAL“

drinking cup / vaso / gobelet



| | Ø cm | ↑ cm | ltr. | VE |
|-------|------|------|------|----|
| 10501 | 8 | 12,5 | 0,3 | 48 |

Ersatzteile Getränkspender „NORDIC WOOD“

parts beverage dispenser
recambios dispensador de bebidas
pièces distributeur de boissons

Ersatz-Deckel / replacement lid / tapa de recambio / couvercle de rechange

| | Ø cm | ↑ cm |
|-------|------|------|
| 10428 | 11,5 | 1,5 |

Ersatz-Glas inklusive Zapfhahn / replacement glass with tap / cristal de recambio con grifo / vitre de rechange avec robinet

| | Ø cm | ↑ cm | ltr. |
|-------|------|------|------|
| 10427 | 17 | 46 | 7,5 |

Ersatz-Untersetzer aus Kork / replacement cork coaster / posavasos de corcho de recambio / soucoupes de liège de rechange

| | Ø cm | ↑ cm |
|-------|------|------|
| 10424 | 16,5 | 1,5 |

Ersatz-Gestell / stand for / soporte de recambio / support de remplacement

| | cm | ↑ cm | Farbe / Colour |
|-------|---------|------|---|
| 10426 | 23 x 23 | 14 |  |



Saftdispenser „TOP FRESH“

juice dispenser
dispensador de zumo
distributeur à jus de fruit



hochglanzpoliert, Kühlung durch 2 Kühlakkus von oben und unten
mirror polished, cooling with 2 cooling elements from the top and base

pulido brillante, con 2 acumuladores de frío, 1 arriba y 1 en la base
poli brillante, 2 accumulateurs de froid, 1 dans le couvercle, 1 dans le socle

| | cm | ↑ cm | ltr. |
|-------|---------|------|------|
| 10800 | 21 x 32 | 43 | 4 |
| 10700 | 23 x 35 | 52 | 6 |



Saftdispenser DUO „TOP FRESH“

juice dispenser
dispensador de zumo
distributeur à jus de fruit



hochglanzpoliert, Kühlung durch 2 Kühlakkus von oben und unten

mirror polished, cooling with 2 cooling elements from the top and base

pulido brillante, con 2 acumuladores de frío, 1 arriba y 1 en la base
poli brillante, 2 accumulateurs de froid, 1 dans le couvercle, 1 dans le socle

| | cm | ↑ cm | ltr. |
|-------|---------|------|-------|
| 10720 | 42 x 32 | 52 | 2 x 6 |



Saftdispenser „INOX STAR“

juice dispenser
dispensador de zumo
distributeur à jus de fruit



Edelstahl-Crushed Ice Röhre herausnehmbar

removable stainless steel crash ice tube
con tubo inox refrigerante extraíble para hielo picado
avec tube inox réfrigérant amovible pour glace pilée

| | cm | ↑ cm | ltr. |
|-------|---------|------|------|
| 10795 | 36 x 26 | 55 | 8 |

Behälter / container / recipiente / récipient

| | Ø cm | ltr. |
|-------|------|------|
| 10796 | 22 | 8 |



Iso-Dispenser

insulated dispenser
dispensador isotérmico
distributeur de boisson isothermique



für heiÙe und kalte Getränke

for hot and cold drinks
para bebidas frías y calientes
pour boissons chaudes ou froides

| | Ø cm | ↑ cm | ltr. |
|-------|------|------|------|
| 10788 | 24 | 42 | 9,5 |

Hahn / tap / grifo / robinet

| | | | |
|-------|--|--|--|
| 10789 | | | |
|-------|--|--|--|

BEVERAGE DISPENSERS



1) Deckel / cover / tapa / couvercle

für ltr. / for ltr. / para ltr. / pour ltr.

| | |
|-------|---|
| 10701 | 6 |
| 10801 | 4 |

2) Kühlakku / cooler / acumulador de frío / accumulateur de froid

für ltr. / for ltr. / para ltr. / pour ltr.

| | |
|-------|-------|
| 10777 | 4 / 6 |
|-------|-------|

3) Behälter inklusive Zapfhahn / container incl. tap recipiente con grifo / récipient avec robinet

für ltr. / for ltr. / para ltr. / pour ltr.

| | |
|-------|---|
| 10703 | 6 |
| 10803 | 4 |

3) Behälter ohne Zapfhahn / container without tap recipiente sin grifo / récipient sans robinet

für ltr. / for ltr. / para ltr. / pour ltr.

| | |
|-------|---|
| 10704 | 6 |
| 10804 | 4 |

4) Non-Drip Hahn / non-drip tap / grifo anti-goteo / robinet anti-goutte

für ltr. / for ltr. / para ltr. / pour ltr.

| | |
|-------|---|
| 10707 | 6 |
| 10807 | 4 |

5) Dichtungsring / sealing ring / arandela / rondelle

für ltr. / for ltr. / para ltr. / pour ltr.

| | |
|-------|-------|
| 10608 | 4 / 6 |
|-------|-------|

6) Einsatz / insert / aro inox / cercle inox

für ltr. / for ltr. / para ltr. / pour ltr.

| | |
|-------|---|
| 10708 | 6 |
| 10808 | 4 |

7) Standfuß 18/10 Edelstahl / column 18/10 stainless steel base inox 18/10 / socle inox 18/10

für ltr. / for ltr. / para ltr. / pour ltr.

| | |
|-------|---|
| 10709 | 6 |
| 10809 | 4 |

8) Tropfgitter 18/10 Edelstahl / drip lattice 18/10 stainless steel rejilla recoge gotas 18/10 / grille ramasse-gouttes 18/10

für ltr. / for ltr. / para ltr. / pour ltr.

| | |
|-------|-----|
| 10712 | 6 |
| 10713 | DUO |
| 10812 | 4 |

9) Bodenplatte 18/10 Edelstahl / footing 18/10 stainless steel base de 18/10 acero / socle inox 18/10

für ltr. / for ltr. / para ltr. / pour ltr.

| | |
|-------|-------------|
| 10710 | 6 |
| 10711 | DUO / 6 + 6 |
| 10814 | 4 |

1x Dichtung, 2x Dichtungsring (transparent), 1x Dichtung (s / w) 1x seal, 2x sealing ring (transparent), 1x sealing ring (b / w)

Zubehör / Reinigungsset - für die regelmäßige Reinigung

| | |
|-------|--------------------|
| 10714 | für Zapfhahn 10707 |
| 10715 | für Zapfhahn 10807 |
| 10716 | für Zapfhahn 10907 |
| 10717 | für Zapfhahn 10867 |





Der Adapter passt auf alle Dispenser der Serien TOP FRESH, BRIDGE und SUNDAY und kann ganz einfach installiert werden.

The adapter fits all dispensers of the series TOP FRESH, BRIDGE and SUNDAY and can be installed very easily.

El adaptador se adapta a todos los dispensadores de las series TOP FRESH, BRIDGE y SUNDAY y puede ser instalado fácilmente.

L'adaptateur s'adapte à tous les distributeurs des séries TOP FRESH, BRIDGE et SUNDAY et peut être installé très facilement.

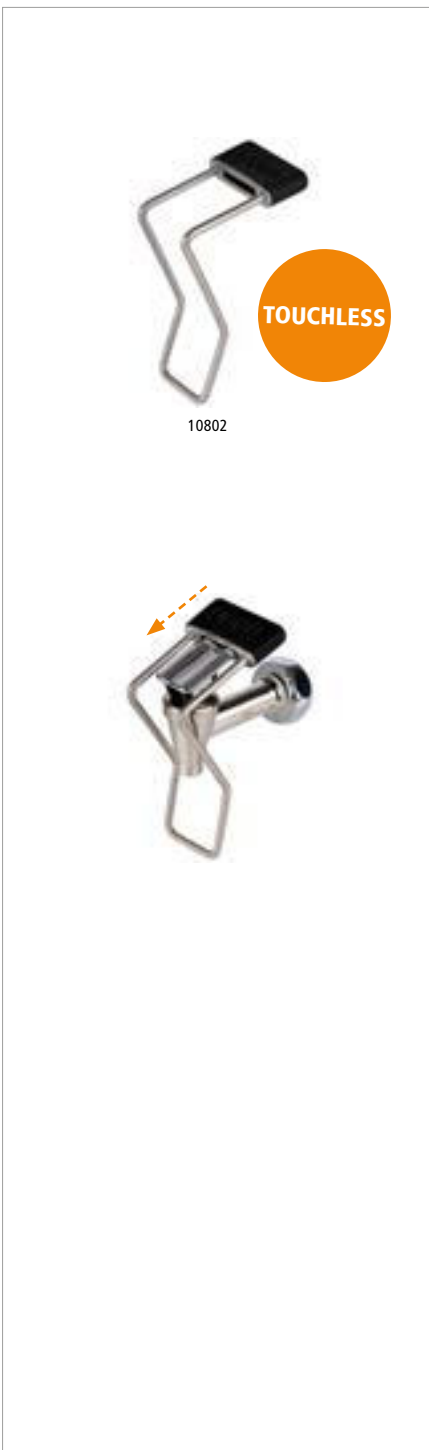

Adapter „TOP FRESH“

adapter
adaptador
adaptateur



handkontaktloser Adapter, einfach zu installieren

adapter touchless for tap, easy to install

adaptador sin contacto para grifo

adaptateur sans contact manuel, facile à installer

| | cm | ↑ cm |
|-------|----------|------|
| 10802 | 12 x 4,5 | 5,5 |



Einfach den Adapter an der dafür vorgesehenen Öffnung auf den Hebel des Zapfhahns stecken.

Simply plug the adapter onto the lever of the tap at the opening provided.

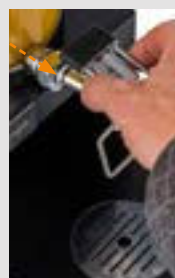

Anschließend den Adapter nach unten festziehen. Durch das Nach-Vorne-Drücken des unteren Edelstahlbügels mit Hilfe des Glases, wird der Hebel des Zapfhahns betätigt und das Getränk fließt völlig handkontaktlos in das Glas.

Then tighten the adapter downwards. By pushing the lower stainless steel bracket forward with the help of the glass, the lever of the tap is activated and the drink flows into the glass completely without hand contact.

passend für / suitable for:



Saftdispenser „TOP FRESH“
Katalog Seite 46
juice dispenser,
catalogue page 46



Milchkanne „TOP FRESH“
Katalog Seite 51
milk dispenser,
catalogue page 51



Saftdispenser „BRIDGE“
Katalog Seite 20
juice dispenser,
catalogue page 20

BEVERAGE DISPENSERS



Saftdispenser „TOWER“

juice dispenser
dispensador de zumo
distributeur à jus de fruit

aus Edelstahl, inklusive Crushed Ice Röhre

made of stainless steel, inclusive crushed ice tube
de acero inoxidable con tubo para hielo picado
en acier inox avec tube de glace pilée



5 ltr.

| | cm | ↑ cm | ltr. |
|-------|---------|------|------|
| 10440 | 35 x 23 | 75 | 5 |



Edelstahl Zapfhahn
stainless steel tap



Milchdispenser „BRIDGE“

milk dispenser
dispensador de leche
distributeur à lait

massives Buchenholz gebeizt, Edelstahldispenser mit 1 Kühlakku im Standfuß inklusive touchless adapter

solid beech wood, stained, stainless steel dispenser with 1 cooler in stand including touchless adapter

madera de haya maciza teñida, dispensador de acero inoxidable con 1 acumulador de frío en la base y con adaptador sin contacto para grifo

bois de hêtre massif teinté, distributeur en acier inox avec 1 accumulateur de froid dans le socle et avec adaptateur sans contact manuel



| | cm | ↑ cm | ltr. | Farbe / Colour |
|-------|---------|------|------|----------------|
| 10837 | 31 x 20 | 39 | 3 | ■ |
| 10839 | 39 x 22 | 45 | 5 | ■ |



Milchdispenser „BRIDGE“

milk dispenser
dispensador de leche
distributeur à lait

massives Ahornholz, Edelstahldispenser mit 1 Kühlakku im Standfuß inklusive touchless adapter

solid maple wood, stainless steel dispenser with 1 cooler in stand including touchless adapter
madera maciza de arce, dispensador de acero inoxidable con 1 acumulador de frío en la base y con adaptador sin contacto para grifo

bois d'érable massif, distributeur en acier inox avec 1 accumulateur de froid dans le socle et avec adaptateur sans contact manuel



| | cm | ↑ cm | ltr. | Farbe / Colour |
|-------|---------|------|------|----------------|
| 10836 | 31 x 20 | 39 | 3 | ■ |
| 10838 | 39 x 22 | 45 | 5 | ■ |



Saftdispenser „BRIDGE“

juice dispenser
dispensador de zumo
distributeur à jus



Kühlung durch 2 Kühllakkus von oben und unten

cooling with 2 coolers from the top and base

2 acumuladores de frío: 1 en la base y 1 en la tapa

2 accumulateurs de froid: 1 dans le couvercle, 1 dans le socle

| | cm | ↑ cm | ltr. | Farbe / Colour |
|-------|-----------|------|------|----------------|
| 10872 | 31,0 x 20 | 42 | 4 | ■ |
| 10873 | 35,5 x 22 | 50 | 6 | ■ |



inklusive 3 Magnetschilder: ORANGE, APPLE, GRAPEFRUIT
including 3 magnetic signs: ORANGE, APPLE, GRAPEFRUIT



Saftdispenser „BRIDGE“

juice dispenser
dispensador de zumo
distributeur à jus



Kühlung durch 2 Kühllakkus von oben und unten

cooling with 2 coolers from the top and base

2 acumuladores de frío: 1 en la base y 1 en la tapa

2 accumulateurs de froid: 1 dans le couvercle, 1 dans le socle

| | cm | ↑ cm | ltr. | Farbe / Colour |
|-------|-----------|------|------|----------------|
| 10870 | 31,0 x 20 | 42 | 4 | ■ |
| 10871 | 35,5 x 22 | 50 | 6 | ■ |



inklusive 3 Magnetschilder: ORANGE, APPLE, GRAPEFRUIT
including 3 magnetic signs: ORANGE, APPLE, GRAPEFRUIT



Milchkanne „TOP FRESH“

milk dispenser
dispensador de leche
distributeur à lait



hochglanzpoliert, 1 Kühllakku im Standfuß, „original Milchkanne mit Henkel“

mirror polished, 1 cooler in base, original milkcan

pulido brillante, 1 acumulador de frío en la base, recipiente „lechera“

poli brillant, 1 accumulateur de froid dans le socle, design „pot à lait“

| | cm | ↑ cm | ltr. |
|-------|---------|------|------|
| 10830 | 21 x 32 | 39 | 3 |
| 10750 | 23 x 35 | 45 | 5 |

Milchkanne ohne Zapfhahn / milkcan without tap / jarra de leche sin grifo / récipient à lait sans robinet

| | Ø cm | ↑ cm | ltr. |
|-------|------|------|------|
| 10833 | 16 | 22 | 3 |
| 10663 | 22 | 26 | 5 |

BEVERAGE DISPENSERS



Milchkanne „TOP FRESH“

milk dispenser
dispensador de leche
distributeur à lait



inklusive Porzellanschild zum Beschriften, 1 Kühlakku im Fuß

including porcelain sign, 1 cooler in base
incluye cartelito en porcelana, 1 acumulador de frío en la base
indicateur en porcelaine inclus, 1 accumulateur de froid dans le socle

| | cm | ↑ cm | ltr. |
|-------|---------|------|------|
| 10850 | 31 x 21 | 42 | 4 |



Milchkanne „TOP FRESH“

milk dispenser
dispensador de leche
distributeur à lait



Buchenholz versiegelt, inklusive Porzellanschild zum Beschriften, 1 Kühlakku im Fuß

beech wood, waterproof, incl. porcelain sign, 1 cooler in base
madera de haya, resistente al agua, incluye placa de porcelana, 1 acumulador de frío en la base
socle bois hêtre traité, indicateur en porcelaine inclus, 1 accumulateur de froid dans le socle

| | cm | ↑ cm | ltr. |
|-------|-----------|------|------|
| 10840 | 23 x 32,0 | 42 | 4 |
| 10757 | 27 x 38,5 | 45 | 8 |

Milchkanne Porzellan, ohne Zapfhahn / milkan porcelain, without tap / jarra de leche sin grifo / récipient en porcelaine sans robinet

| | Ø cm | ↑ cm | ltr. |
|-------|------|------|------|
| 10825 | 18 | 25 | 4 |
| 10758 | 22 | 26 | 8 |

Deckel für 10840, 10850 / cover for 10840, 10850 / tapa para 10840, 10850 / couvercle pour 10840, 10850

10859

Deckel für 10757 / cover for 10757 / tapa para 10757 / couvercle pour 10757

10759

Schild und Kette / shield and chain / placa y cadena / indicateur porcelaine avec chaînette

10756

Zapfhahn / tap / grifo / robinet

10907



Kaffeedispenser „HAPPY HOUR“

coffee dispenser
dispensador de café
distributeur de café



hochglanzpoliert, für warme Getränke, stabil und standfest, inklusive 1 Brennpastenbehälter
mirror polished, for warm drinks, solid and stable, including 1 burner holder
pulido brillante, para bebidas calientes, sólido y estable, incluye un calentador
poli brillant, pour boissons chaudes, robuste et stable, avec 1 brûleur

| | cm | ↑ cm | ltr. |
|-------|-----------|------|------|
| 11672 | 31 x 33,5 | 54,5 | 10,5 |

Hahn / tap / grifo / robinet

11671

Elektro-Heizelement / heating unit / resistencia / résistance

| | cm | ↑ cm |
|-------|---------|------|
| 12287 | 21 x 20 | 6 |



Pump-Isolierkanne „PREMIUM“

air pot
jarra termo
bouteille isotherme



matt poliert, doppelwandig, Tragegriff, Drehverschluss, Pumpmechanismus, Füllstandsanzeigefür heiße und kalte Getränke, inklusive 4 Beschriftungsclips, für 24 Tassen

matt polished, double-walled, carrying handle, screw cap, pump mechanism, fill level indicator, for hot and cold beverages, including 4 beverage signs, for 24 cups

pulido mate, doble pared, asa de transporte, tapón de rosca, mecanismo de bombeo, indicador de nivel para bebidas calientes y frías, con 4 clips para marcar, para 24 tazas

poli mat, double paroi, poignée de transport, fermeture rotative, mécanisme de pompage, indicateur de niveau pour boissons chaudes et froides, avec 4 clips d'inscriptions, pour 24 tasses

| | Ø cm | ↑ cm | ltr. | Anzahl der Tassen |
|-------|------|------|------|-------------------|
| 10916 | 15 | 37 | 3 | 24 |

Tropfenfänger für Pump-Isolierkanne / drip tray for air pot / recoge gotas para jarra termo / ramasse-gouttes pour bouteilles isotherme

| | cm | ↑ cm |
|-------|-----------|------|
| 10917 | 24 x 18,5 | 4 |



Pump-Isolierkanne „BUDGET“

air pot
jarra termo
bouteille isotherme



Edelstahl, Polypropylen, matt poliert, doppelwandig, Tragegriff, Dreh-Pumpknopf, für heiße und kalte Getränke, für 17 Tassen

stainless steel, polypropylene, matt polished, double-walled, carrying handle, push-button, for hot and cold beverages, for 17 cups

acero inoxidable, polipropileno, pulido mate, doble pared, asa de transporte, botón giratorio de la bomba, para bebidas calientes y frías, para 17 tazas

acier inox, polypropylène, poli mat, double paroi, poignée de transport, bouton de pompage rotatif, pour boissons chaudes et froides, pour 17 tasses

| | Ø cm | ↑ cm | ltr. | Anzahl der Tassen |
|-------|------|------|------|-------------------|
| 10915 | 13,5 | 32,5 | 2,2 | 17 |

VACUUM JUGS



Isolierkanne „ADVANCED“

vacuum jug
jarra termo
bouteille isotherme



doppelwandig, spülmaschinenfest, Einhandautomatik, aufgeklappt passt die Kanne unter die gängigen Kaffeeautomaten, für heiße und kalte Getränke

double-walled, dishwasher-safe, easy pouring system, with flipped-back lid, the air pot fits under a wide range of coffee makers, for hot and cold beverages

doble pared, resistente al lavavajillas, se maneja con 1 mano, con la tapa abierta la jarra se puede usar con casi todas las cafeteras corrientes, para bebidas frías y calientes

double paroi, résistante au lave-vaisselle, usage à 1 main, avec la couvercle ouverte a bouteille se peut user avec toutes les machines à café courantes, pour boissons chaudes ou froides

| | Ø cm | ↑ cm | ltr. | Anzahl der Tassen |
|-------|------|------|------|-------------------|
| 10921 | 10,5 | 13,0 | 0,3 | 2,5 |
| 10922 | 10,5 | 18,0 | 0,6 | 5,0 |
| 10923 | 13,0 | 19,5 | 1,0 | 8,0 |
| 10924 | 13,0 | 23,5 | 1,5 | 12,0 |



Deckel klappbar
lid foldable



Schutzmantel „HOT WATER“

protective coat
funda protectora
housse de protection



aus braunem Kunstleder, mit Kennzeichnung „HOT WATER“
made of brown imitation leather, with marking „HOT WATER“
imitación cuero marrón, can marcaje „HOT WATER“
en similibuier marron, avec marquage „HOT WATER“



| | cm | ↑ cm | Farbe / colour | fits to |
|-------|---------|------|----------------|---------|
| 10925 | 16 x 16 | 1 | ■ | 10922 |
| 10927 | 20 x 20 | 1 | ■ | 10924 |



Schutzmantel „BLACK COFFEE“

protective coat
funda protectora
housse de protection



aus schwarzem Kunstleder, mit Kennzeichnung „BLACK COFFEE“
made of black imitation leather, with marking „BLACK COFFEE“
imitación cuero negro, can marcaje „BLACK COFFEE“
en similibuier noir, avec marquage „BLACK COFFEE“



| | cm | ↑ cm | Farbe / colour | fits to |
|-------|---------|------|----------------|---------|
| 10926 | 16 x 16 | 1 | ■ | 10922 |
| 10928 | 20 x 20 | 1 | ■ | 10924 |



Isolierkanne „VEGAN ADVANCED“

vacuum jug
jarra termo
bouteille isotherme

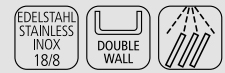

doppelwandig, spülmaschinenfest, Einhandautomatik, aufgeklappt passt die Kanne unter die gängigen Kaffeautomaten, für heiße und kalte Getränke, mit Gravur „VEGAN“

double-walled, dishwasher-safe, easy pouring system, with flipped-back lid, the air pot fits under a wide range of coffee makers, for hot and cold beverages, with engraving „VEGAN“
doble pared, resistente al lavavajillas, se maneja con 1 mano, con la tapa abierta la jarra se puede usar con casi todas las cafeteras corrientes, para bebidas frías y calientes, con grabado „VEGAN“
double paroi, résistante au lave-vaisselle, usage à 1 main, avec la couvercle ouverte a bouteille se peut user avec toutes les machines à café courantes, pour boissons chaudes ou froides, avec gravure „VEGAN“

| | Ø cm | ↑ cm | ltr. | Anzahl der Tassen |
|-------|------|------|------|-------------------|
| 10353 | 10,5 | 18,0 | 0,6 | 5,0 |
| 10354 | 13,0 | 19,5 | 1,0 | 8,0 |



Isolierkanne „CLASSIC“

vacuum jug
jarra termo
bouteille isotherme



doppelwandig, Einhandautomatik, Drehverschluss, für heiße und kalte Getränke, mit Gravur „VEGAN“
double-walled, easy push-button pouring system, screw cap, for hot and cold drinks, with engraving „VEGAN“

doble pared, se maneja con 1 mano, con tapa a rosca, para bebidas frías y calientes, con grabado „VEGAN“
double paroi, usage à 1 main, couvercle à visser, pour boissons chaudes ou froides, avec gravure „VEGAN“

| | Ø cm | ↑ cm | ltr. | Anzahl der Tassen |
|-------|------|------|------|-------------------|
| 10910 | 14 | 19 | 1,0 | 8 |
| 10911 | 14 | 22 | 1,5 | 12 |
| 10912 | 14 | 25 | 2,0 | 16 |



Isolierkanne „VEGAN CLASSIC“

vacuum jug
jarra termo
bouteille isotherme



doppelwandig, Einhandautomatik, Drehverschluss, für heiße und kalte Getränke
double-walled, easy push-button pouring system, screw cap, for hot and cold drinks
doble pared, se maneja con 1 mano, con tapa a rosca, para bebidas frías y calientes
double paroi, usage à 1 main, couvercle à visser, pour boissons chaudes ou froides

| | Ø cm | ↑ cm | ltr. |
|-------|------|------|------|
| 10352 | 14 | 19 | 1,0 |

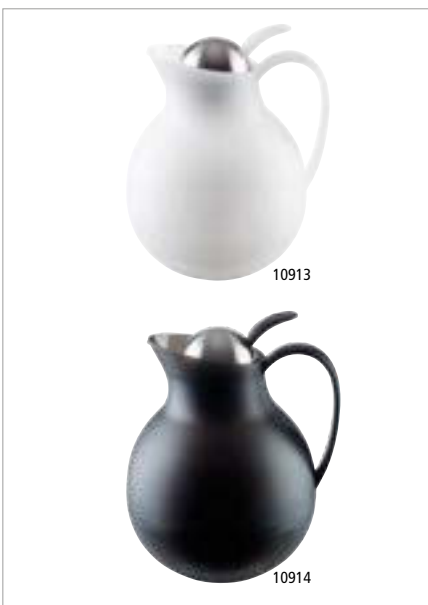

Isolierkanne „ECONOMY“

vacuum jug
jarra termo
bouteille isotherme



robuste Umhüllung mit Polypropylen-Kunststoff, Stabilglaseinsatz, Drehverschluss mit Drucktasten-Bedienung für heiße und kalte Getränke, 8 Tassen

double-walled with glass liner, screw cap with easy push-button pouring system, for hot and cold beverages, 8 cups

exterior de plástico polipropileno, interior aislante de vidrio, con tapa a rosca con cierre dosificador para bebidas frías y calientes, 8 tazas

extérieur en plastique polypropylène, intérieur avec plaque de verre, couvercle à visser, pour boissons chaudes ou froides, 8 tasses

| | Ø cm | ↑ cm | ltr. | Farbe / Colour |
|-------|------|------|------|----------------|
| 10913 | 16 | 20 | 1 | White |
| 10914 | 16 | 20 | 1 | Black |

CARAFES



**3 tlg.
3 pcs.**

1,4 ltr.

Kühlkaraffe, 3-teilig „COOL“

cooling carafe, 3 pcs.

jarra fría, set de 3

pichet rafraîchisseur, set de 3

1 Glaskaraffe mit Edelstahl Ausgießer, öffnet und schließt selbstständig + 1 verchromter Fuß + 1 Kühllakku, werden bis zu 4 Stunden gekühlt

1 glass carafe with stainless steel pourer, open / closing autonomous + 1 chrome plated base + 1 cooling pack, up to 4 hours cooled beverages

1 botella de vidrio con vertedor inox, con autocierre + 1 base cromada + 1 acumulador de frío que mantiene las bebidas frescas hasta unas 4 horas

1 pichet en verre avec insert verseur inox, fermeture automatique + 1 socle chromé + 1 accumulateur de froid pour maintenir les boissons froides jusqu'à 4 heures



| | Ø cm | ↑ cm | ltr. |
|-------|------|------|------|
| 10762 | 16 | 27 | 1,4 |



Edelstahlausgießer
stainless steel pourer



Kühlstation inklusive Kühllakku (schwarz)
including cooler (black)

1,0 ltr.

Glaskaraffe

glass carafe

jarra de vidrio

pichet en verre

der Deckel öffnet sich beim Ausgießen automatisch

cover opens automatically while pouring

la tapa se abre automáticamente durante el vertido

le couvercle s'ouvre seul pendant le service



| | Ø cm | ↑ cm | ltr. |
|-------|------|------|------|
| 10766 | 9,5 | 29 | 1 |

1,5 ltr.

Saft- / Wasserkanne

juice / water pitcher

jarra de zumo / agua

pichet à eau ou jus de fruit

Deckel aus Edelstahl matt poliert, Ausgießer für tropffreies Ausgießen

stainless steel cover, matt polished, spout for drip-free pouring

tapa de acero inoxidable pulido mate, pico para verter sin gotear

couvercle en acier inox poli mat, bec verseur pour verser sans goutter



| | Ø cm | ↑ cm | ltr. |
|-------|------|------|------|
| 10764 | 9,5 | 27 | 1,5 |



Glaskaraffe
glass carafe
jarra de vidrio
carafe en verre



Deckel aus Edelstahl matt poliert, mit integriertem Auffangsieb für Kerne oder Eis
lid made of matt polished stainless steel, with integrated strainer for cores or ice
tapa de acero inoxidable pulido mate, con filtro integrado para los huesos o el hielo
couvercle en acier inox poli mat, avec filtre intégré pour les pépins ou la glace

| | Ø cm | ↑ cm | ltr. |
|-------|------|------|------|
| 10792 | 10 | 26 | 1,5 |



Deckel mit Doppelfunktion
lid with double function

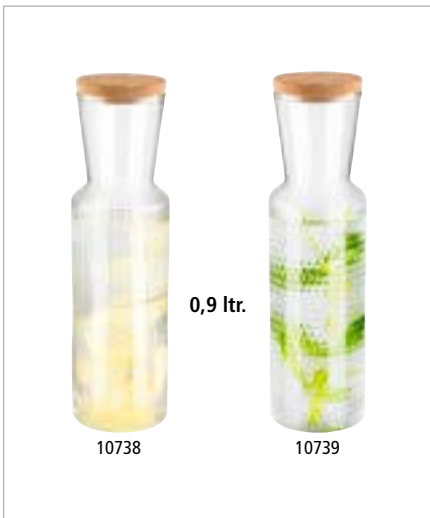

Glaskaraffe
glass carafe
jarra de vidrio
carafe en verre



| | Ø cm | ↑ cm | ltr. | Design |
|-------|------|------|------|--------|
| 10738 | 8 | 27 | 0,9 | LINES |
| 10739 | 8 | 27 | 0,9 | DOTS |



Detailansicht
detail view „LINES“

Detailansicht
detail view „DOTS“

inklusive Korkdeckel
incl. cork cover



Glaskaraffe
glass carafe
jarra de vidrio
carafe en verre



| | Ø cm | ↑ cm | ltr. | Design |
|-------|------|------|------|---------|
| 10741 | 8 | 28 | 0,8 | COMB |
| 10742 | 8 | 28 | 0,8 | DIAMOND |



Detailansicht
detail view „COMB“

Detailansicht
detail view „DIAMOND“

inklusive Holzkorken mit Silikondichtung
including wooden cork with silicone gasket



Glaskaraffe
glass carafe
jarra de vidrio
carafe en verre



Deckel aus Edelstahl matt poliert, Ausgießer für tropffreies Ausgießen
lid made of matt polished stainless steel, spout for drip-free pouring
tapa de acero inoxidable pulido mate, pico para verter sin gotear
couvercle en acier inox poli mat, bec verseur pour verser sans goutter

| | Ø cm | ↑ cm | ltr. |
|-------|------|------|------|
| 10721 | 8 | 25 | 1,0 |
| 10722 | 8 | 32 | 1,3 |

CARAFES



Glaskaraffe „OLD FASHIONED“, 2 teilig

glass carafe, 2 pcs.
jarra de vidrio, set de 2
carafe en verre, set de 2

1 Flasche 1,0 ltr., 1 Glas 0,3 ltr.
1 bottle 1,0 ltr., 1 glass 0,3 ltr.
1 botella 1,0 ltr., 1 vaso 0,3 ltr.
1 bouteille 1,0 ltr., 1 verre 0,3 ltr.



| | Ø cm | ↑ cm | ltr. |
|-------|------|------|------|
| 10690 | 9,5 | 31 | 1,0 |

Ersatzglas / replacement glass / vaso de recambio / verre de remplacement

| | Ø cm | ↑ cm | ltr. | VE / unit |
|-------|------|------|------|-----------|
| 10520 | 8 | 12,5 | 0,3 | 6 |



Glaskaraffe „OLD FASHIONED“

glass carafe
jarra de vidrio
carafe en verre



Deckel mit Auffangsieb für Kerne oder Eis
lid with integrated strainer for cores or ice
tapa con filtro integrado para los huesos o el hielo
couverture avec filtre intégré pour les pépins ou la glace

| | Ø cm | ↑ cm | ltr. |
|-------|------|------|------|
| 10691 | 12 | 26 | 1,8 |



Buffetbrett

buffet board
tabla de buffet
planche de buffet



für Karaffen, mit 3 Einsätzen Ø 11 cm aus Kunstleder, aus geöltem Eichenholz
for carafes, with 3 leatherette inserts Ø 11 cm, made of oiled oak wood
para jarras, con 3 inserciones de imitación de cuero Ø 11 cm, de madera de roble aceitada
pour pichets, avec 3 inserts en cuir synthétique Ø 11 cm, en bois de chêne huilé

| | cm | ↑ cm | Farbe / Colour |
|-------|---------|------|----------------|
| 11705 | 47 x 19 | 2 | natural oak |
| 11706 | 47 x 19 | 2 | dark oak |

6 Einsätze aus Kunstleder / 6 leatherette inserts / 6 inserciones de imitación de cuero / 6 inserts en cuir synthétique

| | Ø cm | Farbe / Colour | pcs. |
|-------|------|----------------|------|
| 35716 | 11 | anthracite | 6 |



Kunstledereinsatz herausnehmbar
removable leatherette insert



Saft- / Wasserkanne

juice / water pitcher
jarra de zumo / agua
pichet à eau ou jus de fruit



mit Eiswasserröhre
with water ice tube
con tubo para hielo
avec tube à glaçons plongeant pour réfrigérer



| | Ø cm | ↑ cm | ltr. |
|-------|------|------|------|
| 10770 | 18 | 29 | 3 |



Soft- / Wasserkanne
juice / water pitcher
jarra de zumo / agua
pichet à eau ou jus de fruit



| | Ø cm | ↑ cm | ltr. |
|-------|------|------|------|
| 10775 | 12 | 26 | 2 |



Soft- / Wasserkanne
juice / water pitcher
jarra de zumo / agua
pichet à eau ou jus de fruit



| | Ø cm | ↑ cm | ltr. |
|-------|------|------|------|
| 10776 | 14 | 29 | 2,5 |



Flasche „STRIPES“
bottle
botella
bouteille



| | Ø cm | ↑ cm | ltr. | Farbe / colour |
|-------|------|------|------|----------------|
| 10748 | 9 | 28,5 | 1 | |
| 10749 | 9 | 28,5 | 1 | |



Soft- / Wasserkanne
juice / water pitcher
jarra de zumo / agua
pichet à eau ou jus de fruit
mit Eiswasserröhre
with water ice tube
con tubo para hielo
avec tube à glaçons plongeant pour réfrigérer



| | cm | ↑ cm | ltr. |
|-------|---------|------|------|
| 10769 | 19 x 13 | 27 | 2,8 |



Karaffe
bottle
botella
bouteille



Schraubdeckel mit aromadichtem Verschluss
screwed lid, aroma-tight
tapón de rosca, impide la fuga de aromas
bouchon à visser, ne laisse pas passer les arômes

| | Ø cm | ↑ cm | ltr. | Farbe / Colour |
|-------|------|------|------|----------------|
| 10771 | 11 | 30 | 1,6 | |

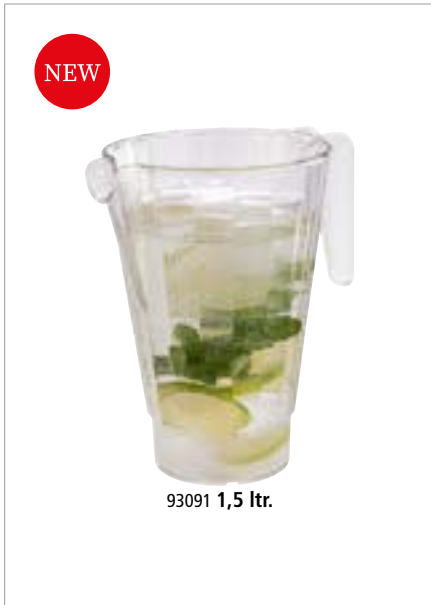

93091 1,5 ltr.

Pitcher
pitcher
jarra
pichet



| | Ø cm | ↑ cm | ltr. |
|-------|------|------|------|
| 93090 | 12,5 | 17,5 | 1,0 |
| 93091 | 13,5 | 20,0 | 1,5 |

passende Deckel / fitting lids / tapa adecuadas / couvercles appropriées

| | cm | ↑ cm | fits to |
|-------|------|------|---------|
| 93092 | 13,0 | 1,5 | 93090 |
| 93093 | 14,0 | 1,5 | 93091 |



Deckel mit Klappe
lid with flap



einfaches Eingießen
easy pouring



stapelbar
stackable



1,5 ltr.

Pitcher
pitcher
jarra
pichet



| | Ø cm | ↑ cm | ltr. |
|-------|------|------|------|
| 93105 | 13 | 21 | 1,5 |



Kühlbox „FROSTY“
bottle cooler
enfriador de botellas
rafraichisseur de bouteilles



mit herausnehmbarem Einsatz für 4 Flaschen
with removable insert for 4 bottles
con inserto extraíble para 4 botellas
avec insert amovible pour 4 bouteilles



Abb. ohne Einsatz
illustration without insert

| | cm | ↑ cm | ltr. | hole ø cm |
|-------|---------|------|------|-----------|
| 93230 | 27 x 27 | 15 | 7,5 | 11 |



7,5 Liter



NEW

Flaschenkühler „BIG BOWL“
bottle cooler
enfriador de botella
rafraichisseur de bouteille



gehämmerte Oberfläche, innen mattiert, herausnehmbarer Tropfeinsatz
hammered surface, matted inside, removable drip tray
superficie martillada, interior mate, bandeja de goteo extraíble
surface martelée, intérieur mat, bac de récupération amovible

| | Ø cm | ↑ cm | ltr. |
|-------|------|------|------|
| 36130 | 37 | 23 | 8 |





36111 7 ltr.

36112 7 ltr.

Wein- / Sektkühler „XL“

wine / champagne bowl
cubitera para vino y cava
seau à vin ou champagne

gehämmerte Oberfläche, mit 2 seitlichen Eingriffen

hammered surface, with 2 handles on the side

superficie martillada, con 2 asas

surface martelée, avec 2 poignées



| | cm | ↑ cm | ltr. | Farbe / Colour |
|-------|-----------|------|------|----------------|
| 36111 | 30 x 23,5 | 23 | 7 | copper-look |
| 36112 | 30 x 23,5 | 23 | 7 | gunmetal-look |



NEW

36109 3,9 ltr.

36108 3,9 ltr.

Wein- / Sektkühler „LARGE“

wine / champagne bowl
cubitera para vino y cava
seau à vin ou champagne

gehämmerte Oberfläche, mit 2 seitlichen Eingriffen, für 1-2 Flasche

hammered surface, with 2 handles on the side, for 1-2 bottle

superficie martillada, con 2 asas, para 1-2 botellas

surface martelée, avec 2 poignées, pour 1-2 bouteilles



| | cm | ↑ cm | ltr. | Farbe / Colour |
|-------|-----------|------|------|----------------|
| 36108 | 25,5 x 19 | 20 | 3,9 | copper-look |
| 36109 | 25,5 x 19 | 20 | 3,9 | gunmetal-look |



NEW

36106 2,1 ltr.

36107 2,1 ltr.

Wein- / Sektkühler „SMALL“

wine / champagne bowl
cubitera para vino y cava
seau à vin ou champagne

gehämmerte Oberfläche, für 1 Flasche

hammered surface, for 1 bottle

superficie martillada, para 1 botella

surface martelée, pour 1 bouteille



| | cm | ↑ cm | ltr. | Farbe / Colour |
|-------|-----------|------|------|----------------|
| 36106 | 20,5 x 14 | 17 | 2,1 | copper-look |
| 36107 | 20,5 x 14 | 17 | 2,1 | gunmetal-look |



36100 11 ltr.

36095 11 ltr.

Getränkewanne „TIN“

beverage tub
barreño botellines

bassine à glace

Metall verzinkt, mit Kunststoffeinsatz

galvanised metal, with plastic insert

metal galvanizado, con inserto de plástico

métal galvanisé, avec insert en plastique



| | cm | ↑ cm | ltr. | Farbe / Colour |
|-------|---------|------|------|------------------|
| 36100 | 40 x 28 | 22 | 11 | copper-look |
| 36101 | 40 x 28 | 22 | 11 | black-metal-look |
| 36095 | 40 x 28 | 22 | 11 | metal-look |
| 36096 | 50 x 23 | 23 | 18 | metal-look |



mit Kunststoffeinsatz
with plastic insert
con inserto de plástico
avec insert en plastique



71490

Kreidestift zum Beschriften | chalk marker for writing
S. 304

CONFERENCE



Flaschenkühler „CONFERENCE“

conference bottle cooler
enfriador múltiple
rafraîchisseur



inklusive Kühllakku, Flaschenöffner, Kronkorkenschale,
mit 6 Öffnungen Ø 6,7 cm für 0,25 - 0,5 Liter-Flaschen

incl. bottle cooler, bottle opener, small cap bowl,
with 6 holes Ø 6,7 cm for 0,25 to 0,5 liter bottles

con acumulador de frío, abridor, recuperador de chapas,
6 plazas Ø 6,7 cm, para botellas de 0,25 a 0,5 ltr.

avec accumulateur de froid, décapsuleur, bol récupérateur
de capsules, 6 places Ø 6,7 cm, pour bouteilles de 0,25 à 0,5 litres

| | Ø cm | ↑ cm | Farbe / Colour |
|-------|------|------|----------------|
| 00620 | 23 | 15 | ■ |
| 00621 | 23 | 15 | ■ |



Kühllakku

cooler
acumulador de frío
accumulateur de froid



| | Ø cm | → cm | Farbe / Colour |
|-------|------|------|----------------|
| 00615 | 7,5 | 11,5 | ■ |



Flaschenöffner

bottle opener
abridor
décapsuleur



| | Ø cm | → cm |
|-------|------|------|
| 00617 | 1 | 13,5 |



Kronkorkenschale

cap bowl
cuenco para chapas
bol récupérateur de capsules



| | Ø cm | ↑ cm | Farbe / Colour |
|-------|------|------|----------------|
| 00618 | 6,5 | 3 | ■ |
| 00619 | 6,5 | 3 | ■ |

TEAPOTS



NEW



10995 0,8 ltr.



10996 0,8 ltr.

mit Teesieb / with tea strainer

Teekanne „ASIA“

teapot
tetera
théière



aus Gusseisen, innen emailliert, abnehmbarer Deckel, mit Teesieb aus Edelstahl
made of cast iron, enamelled inside, removable lid, with tea strainer made of stainless steel
hierro fundido, interior esmaltado, tapa extraíble, con colador de té de acero inoxidable
en fonte, émaillé à l'intérieur, couvercle amovible, avec une passoire à thé en acier inox

| | cm | ↑ cm | ltr. | Farbe / Colour |
|-------|---------|------|------|----------------|
| 10995 | 17 x 14 | 17 | 0,8 | ■ |
| 10996 | 17 x 14 | 17 | 0,8 | ■ |



10991 0,8 ltr.



10992 0,8 ltr.

mit Teesieb / with tea strainer

Teekanne „ASIA“

teapot
tetera
théière



aus Gusseisen, innen emailliert, mit abnehmbarem Deckel,
inklusive Teesieb aus Edelstahl, ideal für 2-3 Tassen. Geeignet für alle Herdarten.
made of cast iron, enamelled inside, with removable lid, incl. tea strainer made of
stainless steel, ideal for 2-3 cups. Suitable for all types of stoves.

hierro fundido, interior esmaltado, con tapa extraíble, incl. colador de
té de acero inoxidable, ideal para 2-3 tazas. Apta para todas las placas de cocina.
en fonte, émaillé à l'intérieur, avec couvercle amovible, y compris une passoire à thé
en acier inox, idéale pour 2-3 tasses. Convient à tous les types de feux (gaz, vitro ou induction).

| | cm | ↑ cm | ltr. | Farbe / Colour |
|-------|-----------|------|------|----------------|
| 10991 | 19,5 x 18 | 15 | 0,8 | ■ |
| 10992 | 19,5 x 18 | 15 | 0,8 | ■ |



0,3 ltr.

ohne Teesieb / without tea strainer

Teekanne „ASIA“

teapot
tetera
théière



aus Gusseisen, innen emailliert, mit abnehmbarem Deckel, ohne Teesieb aus Edelstahl
made of cast iron, enamelled inside, with removable lid, without tea strainer made of
stainless steel
hierro fundido, interior esmaltado, con tapa extraíble, sin colador de té de acero inoxidable
en fonte, émaillé à l'intérieur, avec couvercle amovible, sans une passoire à thé en acier inox

| | cm | ↑ cm | ltr. | Farbe / Colour |
|-------|-----------|------|------|----------------|
| 10990 | 12,5 x 11 | 12,5 | 0,3 | ■ |

TEAPOTS



Stövchen „ASIA“

teapot warmer
calentador de tetera
chauffe-théière



1-flammiges Stövchen aus Gusseisen mit abnehmbarem Deckel (Lieferung ohne Teelicht).

1-flame cast iron warmer with removable lid (delivery without tealight).

calentador de tetera de hierro fundido con 1 quemador con tapa extraíble (se entrega sin vela).

chauffe-théière en fonte à 1 brûleur avec couvercle amovible (livraison sans bougie).

| | Ø cm | ↑ cm | Farbe / Colour |
|-------|------|------|----------------|
| 10994 | 13 | 7,5 | ■ |

Untersetzer aus Gusseisen mit Antirutschfüßchen / cast iron coaster with non-slip feet

| | Ø cm | ↑ cm | Farbe / Colour |
|-------|------|------|----------------|
| 10993 | 13,5 | 1,5 | ■ |



Teebox

tea-box
caja para té
boîte à thés et infusions



Box aus Rubberwood mit Sichtfenster, mit Aufschrift „Tee“, 4 Kammern können mit je 30 kuvertierten Teebeuteln bestückt werden

rubber wood box with clear transparent window, with inscription „Tee“, 4 chambers for approx. 30 tea bags each

caja de madera de goma clara con ventana transparente, con inscripción „Tee“, 4 compartimentos, y cada uno para aproximadamente 30 bolsitas de té

en bois d'hévéa clair avec fenêtré, avec inscription „Tee“, 4 compartiments, pour environ 30 sachets chacun

| | cm | ↑ cm | Farbe / Colour |
|-------|-----------|------|----------------|
| 11575 | 33,5 x 20 | 9 | ■ |
| 11574 | 33,5 x 20 | 9 | ■ |

| | cm | ↑ cm | Farbe / Colour | |
|-------|-----------|------|----------------|---|
| 11576 | 33,5 x 20 | 9 | ■ | ohne Aufschrift / without inscription sin inscripción / sans inscription |



Teebox

tea-box
caja para té
boîte à thés et infusions



Box aus Rubberwood mit Sichtfenster, mit Aufschrift „Tee“, 12 Kammern können mit je 12 kuvertierten Teebeuteln bestückt werden

rubber wood box with clear transparent window, with inscription „Tee“, 12 chambers for approx. 12 tea bags each

caja de madera de goma clara con ventana transparente, con inscripción „Tee“, 12 compartimentos, y cada uno para aproximadamente 12 bolsitas de té

en bois d'hévéa clair avec fenêtré, avec inscription „Tee“, 12 compartiments, pour environ 12 sachets chacun

| | cm | ↑ cm | Farbe / Colour |
|-------|---------|------|----------------|
| 11775 | 31 x 28 | 9 | ■ |
| 11776 | 31 x 28 | 9 | ■ |



Teebox / Multibox

tea caddy
caja para té
boîte à thés et infusions



3 Fächer für kuvertierte Teebeutel, 1 Fach für Zucker, Kekse, etc., Deckel aufklappbar

3 compartments for tea bags, 1 compartment for sugar, biscuits, etc., hinged lid

3 compartimentos para bolsitas de té, 1 compartimento para azúcar, galletas, etc. tapa abatible

3 compartiments pour sachets de thé, 1 compartiment pour sucre, biscuits, etc., couvercle abatible

| | cm | ↑ cm |
|-------|---------|------|
| 11563 | 22 x 17 | 9 |

CEREAL DISPENSERS



Cerealienspender „FRESH & EASY“

cereal dispenser
dispensador de cereales
distributeur de céréales

Black
&
beautiful

SAN
KUNSTSTOFF

SILIKON
SILICON

GUSS
ZINK

EDELSTAHL
STAINLESS
INOX

Behälter herausnehmbar, „Feierabend-Deckel“ für das aromadichte Lagern,
portionieren durch einfaches Drehen

removable canister, special lid to keep the cereals fresh, easy to use, rotate the button
to get the muesli

contenedor extraíble, tapa especial para mantener los cereales frescos, fácil de usar,
se gira el pomo para servir los cereales

réipient amovible, couvercle spécial pour conserver les céréales,
usage facile en tournant le bouton

| | cm | ↑ cm | ltr. | Farbe / Colour |
|-------|-----------|------|------|----------------|
| 11840 | 22 x 17,5 | 52 | 4,5 | ■ |



Cerealienspender Duo „FRESH & EASY“

cereal dispenser
dispensador de cereales
distributeur de céréales

Black
&
beautiful

SAN
KUNSTSTOFF

SILIKON
SILICON

GUSS
ZINK

EDELSTAHL
STAINLESS
INOX

Behälter herausnehmbar, „Feierabend-Deckel“ für das aromadichte Lagern,
portionieren durch einfaches Drehen

removable canister, special lid to keep the cereals fresh, easy to use, rotate the button
to get the muesli

contenedor extraíble, tapa especial para mantener los cereales frescos, fácil de usar,
se gira el pomo para servir los cereales

réipient amovible, couvercle spécial pour conserver les céréales, usage facile en
tournant le bouton

| | cm | ↑ cm | ltr. | Farbe / Colour |
|-------|---------|------|---------|----------------|
| 11841 | 22 x 35 | 52 | 2 x 4,5 | ■ |

CEREAL DISPENSERS



Cerealienspender „FRESH & EASY“

cereal dispenser
dispensador de cereales
distributeur de céréales



Behälter herausnehmbar, „Feierabend-Deckel“ für das aromadichte Lagern, portionieren durch einfaches Drehen

removable canister, special lid to keep the cereals fresh, easy to use, rotate the button to get the muesli
contenedor extraíble, tapa especial para mantener los cereales frescos, fácil de usar, se gira el pomo para servir los cereales
récipient amovible, couvercle spécial pour conserver les céréales, usage facile en tournant le bouton

| | cm | ↑ cm | ltr. |
|-------|-----------|------|------|
| 11805 | 22 x 17,5 | 52 | 4,5 |



Cerealienspender Duo „FRESH & EASY“

cereal dispenser
dispensador de cereales
distributeur de céréales



Behälter herausnehmbar, „Feierabend-Deckel“ für das aromadichte Lagern, portionieren durch einfaches Drehen

removable canister, special lid to keep the cereals fresh, easy to use, rotate the button to get the muesli
contenedor extraíble, tapa especial para mantener los cereales frescos, fácil de usar, se gira el pomo para servir los cereales
récipient amovible, couvercle spécial pour conserver les céréales, usage facile en tournant le bouton

| | cm | ↑ cm | ltr. |
|-------|---------|------|---------|
| 11807 | 22 x 35 | 52 | 2 x 4,5 |



Cerealienspender „ROTATION“

cereal dispenser
dispensador de cereales
distributeur de céréales



matt poliert, drehbarer massiver Ständer, Behälter herausnehmbar, inklusive Frischhaltedeckel

matt polished, rotating food, canister removable, including airtight covers
pulido mate, giratorio, incluye tapas herméticas
poli mat, rotatif, inclut couvercles hermétiques

| | Ø cm | ↑ cm | ltr. |
|-------|------|------|---------|
| 11970 | 38 | 54 | 3 x 4,5 |



Cerealienspender „ROTATION“

cereal dispenser
dispensador de cereales
distributeur de céréales



Buchenholz versiegelt, drehbarer massiver Ständer, Behälter herausnehmbar, inklusive Frischhaltedeckel

wood beech covered waterproof, rotating foot, canister removable, incl. airtight cover
tapa en madera de haya resistente al agua, pie giratorio, recipiente extraíble, incluye tapa hermética
couvercle en hêtre traitée contre l'humidité, pied rotatif, récipients démontables, inclut couvercles hermétiques

| | Ø cm | ↑ cm | ltr. |
|-------|------|------|---------|
| 11975 | 38 | 54 | 3 x 4,5 |



Cerealienspender „BRIDGE“

cereal dispenser
dispensador de cereales
distributeur de céréales



Behälter herausnehmbar, „Feierabend-Deckel“ für das aromadichte Lagern, portionieren durch einfaches Drehen

removable canister, special lid to keep the cereals fresh,
easy to use, rotate the button to get the muesli
contenedor extraíble, tapa especial para mantener los cereales frescos,
fácil de usar, se gira el pomo para servir los cereales
récipient amovible, couvercle spécial pour conserver les céréales,
usage facile en tournant le bouton

| | cm | ↑ cm | ltr. | Farbe / Colour | |
|-------|---------|------|------|----------------|-------|
| 13987 | 21 x 20 | 55,5 | 4,5 | | Ahorn |



Cerealienspender „BRIDGE“

cereal dispenser
dispensador de cereales
distributeur de céréales



Behälter herausnehmbar, „Feierabend-Deckel“ für das aromadichte Lagern, portionieren durch einfaches Drehen

removable canister, special lid to keep the cereals fresh,
easy to use, rotate the button to get the muesli
contenedor extraíble, tapa especial para mantener los cereales frescos,
fácil de usar, se gira el pomo para servir los cereales
récipient amovible, couvercle spécial pour conserver les céréales,
usage facile en tournant le bouton

| | cm | ↑ cm | ltr. | Farbe / Colour | |
|-------|---------|------|------|----------------|-------|
| 14987 | 21 x 20 | 55,5 | 4,5 | | Wenge |



Buffetständer „GOOD MORNING“

buffet stand
expositor de buffet
présentoir de buffet



4-teiliges Set: 1 Holzständer inklusive 3 Gläser mit luftdichtem Klappdeckel

4 pcs.: 1 wood stand including 3 glasses with airtight cover
set de 4: 1 soporte con 3 cuencos de cristal con cierre hermético
set de 4: 1 présentoir avec 3 bols en verre avec fermeture hermétique

| | cm | Farbe / Colour | |
|-------|---------|----------------|-------|
| 13965 | 43 x 17 | | Ahorn |
| 14965 | 43 x 17 | | Wenge |

Glas mit luftdichtem Klappdeckel

glass with airtight cover
cristal, cierre hermético
verre, fermeture hermétique

| | cm | ↑ cm | ltr. |
|-------|---------|------|------|
| 82328 | 12 x 12 | 22 | 2 |

CEREAL DISPENSERS

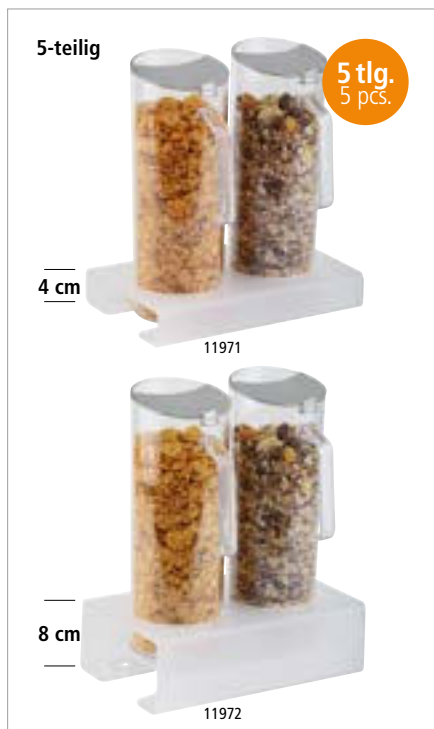

Cerealien-Bar

cereal-bar

barra para dispensador de cereales

bar à céréales



5-teiliges Set: mit Ständerhöhe 4 oder 8 cm: 1 Ständer aus Acryl gefrostet und rutschfest + 2 Karaffen mit schwenkbarem Edelstahl-Deckel + 2 luftdichte Frischhaltedeckel

5 pcs.: with stand heights 4 or 8 cm: 1 stand acryl frosted and non-slip + 2 pitchers with stainless steel flap lid + 2 airtight covers

set de 5: stands a diferentes alturas, 4 u 8 cm: 1 stand acryl + 2 jarras con tapa de solapa de acero inoxidable + 2 tapas herméticas adicionales

set de 5: supports à différentes hauteurs: 4 ou 8 cm - 1 support acrylique satiné antidérapant + 2 pichets à céréales avec couvercle à charnière inox + 2 couvercles hermétiques

| | cm | ↑ cm | ltr. |
|-------|---------|------|---------|
| 11971 | 26 x 17 | 28,5 | 2 x 1,5 |
| 11972 | 26 x 17 | 32,5 | 2 x 1,5 |



ideal für Stufenpräsentation
best for staged presentations

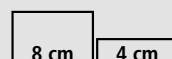

Cerealien-Bar

cereal-bar

barra para dispensador de cereales

bar à céréales



7-teiliges Set: mit Ständerhöhe 4 oder 8 cm: 1 Ständer aus Acryl gefrostet und rutschfest + 3 Karaffen mit schwenkbarem Edelstahl-Deckel + 3 luftdichte Frischhaltedeckel

7 pcs.: with stand heights 4 or 8 cm: 1 stand acryl frosted and non-slip + 3 pitchers with stainless steel flap lid + 3 airtight covers

set de 7: con stands a diferentes alturas, 4 u 8 cm: 1 stand acryl + 3 jarras con tapa de solapa de acero inoxidable + 3 tapas herméticas adicionales

set de 7: supports à différentes hauteurs: 4 ou 8 cm - 1 support acrylique satiné antidérapant + 3 pichets à céréales avec couvercle à charnière inox + 3 couvercles hermétiques

| | cm | ↑ cm | ltr. |
|-------|---------|------|---------|
| 11973 | 38 x 17 | 28,5 | 3 x 1,5 |
| 11974 | 38 x 17 | 32,5 | 3 x 1,5 |



ideal für Stufenpräsentation
best for staged presentations



Cerealienkaraffe

cereal pitcher

jarra de cereales

pichet à céréales



schwenkbarer Edelstahl-Deckel, inklusive luftdichtem Frischhaltedeckel

stainless steel flap lid, incl. 1 airtight cover

tapa giratoria de acero inoxidable con tapa hermética para mantener los alimentos frescos

couvercle pivotant en acier inox avec couvercle hermétique pour conserver les aliments

| | Ø cm | ↑ cm | ltr. |
|-------|------|------|------|
| 10778 | 10 | 28 | 1,5 |

Frischhaltedeckel / conservation lid / tapa de conservación / couvercle de conservation

10668

CANISTERS



82255 1,0 ltr.



82256 2,0 ltr.



82257 2,5 ltr.

Vorratsglas „WOODY“

canister with lid
bote con tapa
pot en verre avec couvercle

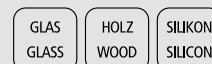

Glasbehälter mit Holzdeckel, aromadichter Verschluss

glass container, aroma-tight screw cap

recipiente de cristal, tapa con cierre hermético para conservar el aroma

réipient en verre, couvercle avec fermeture hermétique pour conserver l'arôme

| | cm | ↑ cm | ltr. |
|-------|---------|------|------|
| 82255 | 14 x 14 | 11,0 | 1,0 |
| 82256 | 14 x 14 | 17,0 | 2,0 |
| 82257 | 14 x 14 | 21,5 | 2,5 |



Holzdeckel aus Kiefernholz mit Silikondichtung
wooden lid from pine wood with silicone gasket



82265 1 ltr.



82266 1,2 ltr.



82267 1,5 ltr.

Vorratsglas

canister with lid
bote con tapa
pot en verre avec couvercle



inklusive Glasdeckel mit Dichtung und Beschriftungsfeld, somit bleibt Ihre Ware frisch

including glass lid with seal and labeling field, thus, your goods remain fresh

con tapa de vidrio con junta y campo de etiquetado, por lo tanto, sus productos permanecen frescos

y compris couvercle en verre avec joint et le domaine de l'étiquetage, ainsi, vos marchandises restent fraîches

| | Ø cm | ↑ cm | ltr. |
|-------|------|------|------|
| 82265 | 11,0 | 18,0 | 1,0 |
| 82266 | 11,5 | 19,5 | 1,2 |
| 82267 | 12,0 | 21,0 | 1,5 |



71490

Kreidestift zum
Beschriften | chalk
marker for writing
S. 304

CANISTERS



Vorratsglas „CLASSIC“

canister with lid
bote con tapa
pot en verre avec couvercle



inklusive Glasdeckel mit Dichtung, somit bleibt Ihre Ware frisch

including glass lid with seal, thus, your goods remain fresh

con tapa de vidrio con junta, por lo tanto, sus productos permanecen frescos

y compris couvercle en verre avec joint, ainsi, vos marchandises restent fraîches

| | Ø cm | ↑ cm | ltr. |
|-------|------|------|------|
| 82250 | 11,5 | 16,0 | 0,9 |
| 82251 | 14,0 | 21,5 | 2,0 |
| 82252 | 18,0 | 26,0 | 4,0 |
| 82253 | 20,0 | 30,0 | 6,0 |



Vorratsglas mit luftdichtem Klappdeckel

glass with airtight cover
bote con cierre hermético
pot en verre avec fermeture hermétique



| | cm | ↑ cm | ltr. |
|-------|---------|------|------|
| 82328 | 12 x 12 | 22 | 2 |



seitlich gestellt
placed sideways
1 ltr.

hochkant gestellt
placed upright
2,2 ltr.

Vorratsglas

canister with lid
bote con tapa
pot en verre avec couvercle



mit Löffel, Schraubdeckel mit aromadichtem Verschluss, Edelstahlöffel mit magnetischem Silikongriff

tight cover, stainless steel spoon with magnetic silicone handle

tapa a rosca con cierre hermético, cuchara de acero inoxidable con mango de silicona magnético

couvercle à vis avec fermeture hermétique, cuillère en acier inox avec manche de silicone aimanté

| | cm | ↑ cm | ltr. |
|-------|-----------|------|---------|
| 00636 | 17 x 12,5 | 18 | 1 - 2,2 |

seitlich gestellt
placed sideways
1 ltr.



hochkant gestellt
placed upright
2,2 ltr.

Vorratsglas

canister with lid
bote con tapa
pot en verre avec couvercle
mit Schraubdeckel, aromadichtem Verschluss
aroma-tight screw cap
tapa a rosca para conservar el aroma
couvercle à vis pour conserver l'arôme



| | cm | ↑ cm | ltr. |
|-------|-----------|------|---------|
| 00637 | 17 x 12,5 | 18 | 1 - 2,2 |

stapelbar
stackable

Frontklappe
front lid



11884

11885

Universalbox

box / sweetbox
caja dispensadora
boîte distributrice
ideal als Verkaufsbox, mit Frontdeckel
best to present sweets etc., all-purpose, with front lid
la perfecta solución para presentar golosinas, universal, con tapa frontal
la solution idéale pour les friandises et autres, universel, avec couvercle frontal



| | cm | ↑ cm | Farbe / Colour |
|-------|-----------|------|----------------|
| 11884 | 23 x 14,5 | 15 | White |
| 11885 | 23 x 14,5 | 15 | Red |

Sturzform



82239
370 ml

82240
580 ml

Weck-Gläser mit Deckel, 2er Set

Weck-glasses with lid, 2 pcs.
Weck tarros de vidrio con tapa, set de 2
Weck verrines avec couvercle, set de 2

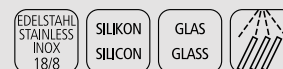

2 Gläser + 2 Edelstahl Deckel
2 glasses + 2 stainless steel lids
2 tarros + 2 tapas de acero inoxidable
2 verrines + 2 couvercles en acier inox

| | Ø cm | ↑ cm | ltr. | pcs |
|-------|------|------|------|-----|
| 82239 | 11 | 7,5 | 0,37 | 2 |
| 82240 | 11 | 11 | 0,58 | 2 |

Sturzform



82243
370 ml

82244
580 ml

Weck-Gläser mit Deckel, 2er Set

Weck-glasses with lid, 2 pcs.
Weck tarros de vidrio con tapa, set de 2
Weck verrines avec couvercle, set de 2



2 Gläser + 2 Deckel aus Buchenholz
2 glasses + 2 beech wood lids
2 tarros + 2 tapas de madera de haya
2 verrines + 2 couvercles en bois hêtre

| | Ø cm | ↑ cm | ltr. | pcs |
|-------|------|------|------|-----|
| 82243 | 11 | 7,5 | 0,37 | 2 |
| 82244 | 11 | 11 | 0,58 | 2 |

NEW PERFECTO



NEW

3 tlg.
3 pcs.



33300

3-teiliges Set | 3 pcs.



33302

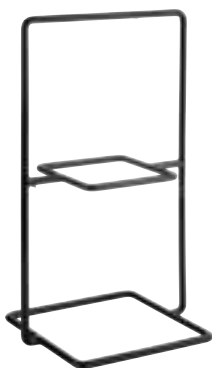

33304



2-stufige Etagère „PERFECTO SMALL“

2-tier tray
bandeja dos alturas
étagère carré 2 hauteurs

HOLZ
WOOD

METALL

PVC
KUNSTSTOFF



3-teiliges Set, bestehend aus:

- 1 Buffetständer, Metall, PVC, schwarz, 23 x 19 cm, H: 40,5 cm
- 2 Bretter aus Eichenholz, geölt, 20 x 20 cm, H: 2 cm

3 pcs., consisting of:

- 1 buffet stand, metal, PVC, black, 23 x 19 cm, h: 40,5 cm
- 2 boards, oiled oak, 20 x 20 cm, h: 2 cm

set de 3, compuesto por:

- 1 soporte de buffet, metal, PVC, negro, 23 x 19 cm, a: 40,5 cm
- 2 tablas de roble aceitado, 20 x 20 cm, a: 2 cm

set de 3, composé de :

- 1 support de buffet, métal, PVC, noir, 23 x 19 cm, H: 40,5 cm
- 2 planches en bois de chêne, huilées, 20 x 20 cm, h: 2 cm

| | | |
|-------|---------|------|
| | cm | ↑ cm |
| 33300 | 20 x 23 | 40,5 |

Brett aus Eichenholz / oak board / tabla de roble / planche en chêne

| | | |
|-------|---------|------|
| | cm | ↑ cm |
| 33302 | 20 x 20 | 2 |

Buffetständer / buffet stand / soporte de buffet / support de buffet

| | | |
|-------|---------|------|
| | cm | ↑ cm |
| 33304 | 19 x 23 | 40,5 |



Präsentationsmöglichkeit
presentation example



2-stufige Etagère „PERFECTO LARGE“

2-tier tray
bandeja dos alturas
étagère carré 2 hauteurs



4-teiliges Set, bestehend aus:

- 2 Buffetständer, Metall, PVC, schwarz, 23 x 19 cm, H: 40,5 cm
- 2 Bretter aus Eichenholz, geölt, 80 x 20 cm, H: 2 cm

4 pcs., consisting of:

- 2 buffet stands, metal, PVC, black, 23 x 19 cm, h: 40,5 cm
- 2 boards, oiled oak, 80 x 20 cm, h: 2 cm

set de 4, compuesto por:

- 2 soportes de buffet, metal, PVC, negro, 23 x 19 cm, a: 40,5 cm
- 2 tablas de roble aceitado, 80 x 20 cm, a: 2 cm

set de 4, composé de :

- 2 supports de buffet, métal, PVC, noir, 23 x 19 cm, h: 40,5 cm
- 2 planches en bois de chêne, huilées, 80 x 20 cm, h: 2 cm

| | cm | ↑ cm |
|-------|---------|------|
| 33301 | 80 x 23 | 40,5 |

Brett aus Eichenholz / oak board / tabla de roble / planche en chêne

| | Ø cm | ↑ cm |
|-------|---------|------|
| 33303 | 80 x 20 | 2 |

Buffetständer / buffet stand / soporte de buffet / support de buffet

| | cm | ↑ cm |
|-------|---------|------|
| 33304 | 19 x 23 | 40,5 |



Präsentationsmöglichkeit
presentation example



Präsentationsmöglichkeit 3 Buffetständer + 4 Bretter
presentation example 3 buffet stands / 4 boards

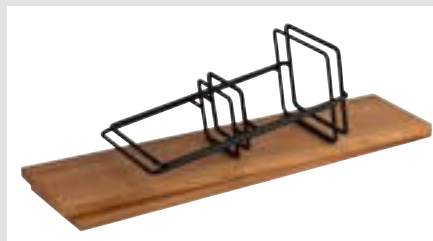

platzsparend
space saving

BUFFET STAND



Eichenholz geölt
oak wood oiled

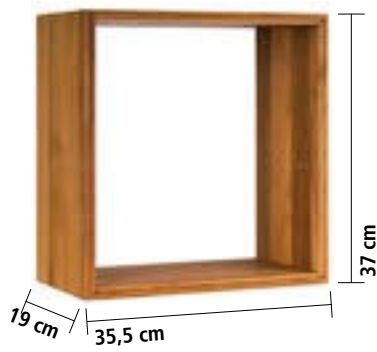

83481
GN 1/3



83491
GN 1/3

Buffetständer „WINDOW“

buffet stand
soporte para buffet
présentoir buffet

Eichenholz geölt
oak wood oiled
madera de roble aceitada
bois de chêne huilé



| | cm | ↑ cm | |
|-------|-----------|------|--|
| 11740 | 35,5 x 19 | 37 | inkl. 20 Haltestiften für Einlegeböden / incl. 20 fixing pins for shelves |



inklusive 20 Haltestifte
including 20 fixing pins



Präsentationsmöglichkeiten
presentation examples

geeignet für GN 1/3 Tablett / for GN 1/3 trays / para bandejas GN 1/3 / pour plateaux GN 1/3

| | cm | ↑ cm | Farbe / Colour |
|-------|-------------|------|----------------|
| 84187 | 32,5 x 17,6 | 1,5 | White |
| 83481 | 32,5 x 17,6 | 3,0 | White |
| 83491 | 32,5 x 17,6 | 3,0 | Black |



NEW

ACACIA

NEW



00794 1,8 ltr.



00795 2,5 ltr.



00796 3,0 ltr.

Schale „ACACIA“

bowl
cuenco
bol

aus geöltem Akazienholz
made of oiled acacia wood
de madera de acacia aceitada
en bois d'acacia huilé



| | Ø cm | ↑ cm | ltr. |
|-------|------|------|------|
| 00794 | 21 | 8,5 | 1,8 |
| 00795 | 25 | 8,5 | 2,5 |
| 00796 | 27 | 8,5 | 3,0 |



passender Deckel mit Löffelaussparung / suitable cover with notched for spoons /
tapa adecuada con espacio para la cuchara / couvercle appropriée avec encoche pour la louche

| | Ø cm | ↑ cm | fits to |
|-------|------|------|---------|
| 83920 | 20,5 | 1,3 | 00794 |



3 Größen ineinander
3 sizes in each other



33269

Buffetständer „MULTI ROUND“

buffet stand
soporte para buffet
présentoir buffet

Metall, mit schwarzer Antirutschbeschichtung
metal, with black anti-slide coating
metal, con revestimiento antideslizante negro
métal, avec revêtement antidérapant noir



| | Ø cm | ↑ cm |
|-------|-----------|------|
| 33269 | 15,5 / 18 | 8 |
| 33270 | 15,5 / 18 | 10 |
| 33271 | 15,5 / 18 | 18 |

BUFFET DISPLAY



Buffet Box „TOAST BOX“

buffet box
caja de buffet
boîte de buffet



aus geöltem Eichenholz, Deckel aus Kunstleder, 2 Fächer: 28 x 16,5 cm, H: 16 cm, mit herausnehmbarem Sichtfenster aus Acryl

made of oiled oak wood, lid made of imitation leather, 2 compartments: 28 x 16.5 cm, H: 16 cm, with removable viewing window made from acrylic

de madera de roble aceitada, tapa de polipiel, 2 compartimentos: 28 x 16,5 cm, H: 16 cm, con mirilla extraíble de acrílico

en bois de chêne huilé, couvercle en simili-cuir, 2 compartiments : 28 x 16,5 cm, H : 16 cm, avec fenêtre d'observation amovible en acrylique

| | cm | ↑ cm | Farbe / Colour |
|-------|-----------|------|----------------|
| 11713 | 36 x 33,5 | 16 | natural oak |
| 11714 | 36 x 33,5 | 16 | dark oak |



Präsentationsmöglichkeit
presentation example



Buffet Box „SEWING BASKET“

buffet box
caja de buffet
boîte de buffet



aus geöltem Eichenholz, 3 Fächer: 33 x 27 cm, H: 7 cm, passend für GN 1/2

made of oiled oak wood, 3 compartments: 33 x 27 cm cm, H: 7 cm, suitable for GN 1/2

de madera de roble aceitada, 3 compartimentos: 33 x 27 cm, H: 7 cm, apto para GN 1/2

en bois de chêne huilé, 3 compartiments: 33 x 27 cm, H: 7 cm, convient pour GN 1/2

| | cm | ↑ cm | Farbe / Colour |
|-------|---------|------|----------------|
| 11711 | 36 x 29 | 28 | natural oak |
| 11712 | 36 x 29 | 28 | dark oak |

geschlossen | closed
37 x 29 cm, H: 28 cm

geöffnet | open
70,5 x 37 cm, H: 53,5 cm



Präsentationsmöglichkeit
presentation example



Buffetgestell „TRIANGLE“

buffet stand
expositor de buffet
présentoir buffet



Ahorn massiv, 3 Ebenen: 1.: 53 x 19 cm, 2.: 40 x 17,5 cm, 3.: 30 x 15 cm
solid maple, 3 levels: 1.: 53 x 19 cm, 2.: 40 x 17,5 cm, 3.: 30 x 15 cm
arce sólido, 3 niveles: 1.: 53 x 19 cm, 2.: 40 x 17,5 cm, 3.: 30 x 15 cm
érable massif, 3 niveaux: 1.: 53 x 19 cm, 2.: 40 x 17,5 cm, 3.: 30 x 15 cm

| | cm | ↑ cm | Farbe / Colour | |
|-------|---------|------|----------------|---------------|
| 13966 | 53 x 21 | 50 | | Ahorn / maple |

Buche massiv, 3 Ebenen: 1.: 53 x 19 cm, 2.: 40 x 17,5 cm, 3.: 30 x 15 cm
beech maple, 3 levels: 1.: 53 x 19 cm, 2.: 40 x 17,5 cm, 3.: 30 x 15 cm
haya sólido, 3 niveles: 1.: 53 x 19 cm, 2.: 40 x 17,5 cm, 3.: 30 x 15 cm
hêtre massif, 3 niveaux: 1.: 53 x 19 cm, 2.: 40 x 17,5 cm, 3.: 30 x 15 cm

| | cm | ↑ cm | Farbe / Colour | |
|-------|---------|------|----------------|---------------|
| 14966 | 53 x 21 | 50 | | Wenge / wenge |



Buffetgestell „BIRDCAGE“

buffet stand
soporte para buffet
présentoir buffet



Gestell aus schwarzem Metall, inklusive 2 Akazienholzplatten
black metal frame, incl. 2 acacia wood panels
soporte metálico negro, con 2 tablas de madera de acacia
support métallique noir, avec 2 panneaux en bois d'acacia

| | Ø cm | ↑ cm |
|-------|------|------|
| 33206 | 26 | 54 |

Ersatz-Holzplatte
spare wooden panel
tabla de madera de recambio
panneau en bois de rechange

| | Ø cm | ↑ cm |
|-------|------|------|
| 33207 | 25 | 1 |



passende Akazienholzplatte
fitting acacia wood panels



Gestell mit abgerundeten Füßen
frame with rounded feet



NEW

FRIENDLY BOWL

- hergestellt aus gebrauchtem Plastik – aus 100% recyceltem Post-Consumer PET (RePET)
- vollständig recycelbar und 100% umweltschonend
- spülmaschinengeeignet bis 55°C
- made from used plastic – made of 100% recycled post-consumer PET (RePET)
- fully recyclable and 100% environmentally friendly
- dishwasher safe up to 55°C
- fabricado de plástico usada: 100% de PET reciclado postconsumo (RePET)
- totalmente reciclable y 100% respetuoso con el medio ambiente
- apto para lavavajillas hasta 55°C
- fabriqué de plastique usagée – composé à 100% de PET recyclé post-consumation (RePET)
- entièrement recyclable et 100% écologique
- lavable au lave-vaisselle jusqu'à 55°C

Safe the Planet:
 Gebrauchtes Plastik
 + Zerkleinern + Reinigen
 + Schmelzen und Spritzen
 = NEUES LEBEN

Safe the Planet:
 used plastic
 + crushing + cleaning
 + melting and spraying
 = NEW LIFE

Safe the Planet:
 plástico usada
 + trituración + limpieza
 + fusión y pulverización
 = NUEVA VIDA

Safe the Planet :
 plastique usagée
 + broyage + nettoyage
 + fonte et injection
 = NOUVELLE VIE



Schale „FRIENDLY BOWL“ bowl cuenco bol



friendly bowl

vollständig recycelbar und 100% umweltschonend
 fully recyclable and 100% environmentally friendly
 totalmente reciclable y 100% respetuoso con el medio ambiente
 entièrement recyclable et 100% écologique

| | cm | ↑ cm | ltr. | Farbe / Colour |
|-------|-------------|------|------|----------------|
| 79000 | 9,0 x 9,0 | 4,0 | 0,14 | ■ |
| 79001 | 9,0 x 9,0 | 4,0 | 0,14 | ■ |
| 79002 | 12,5 x 12,5 | 6,5 | 0,40 | ■ |
| 79003 | 12,5 x 12,5 | 6,5 | 0,40 | ■ |
| 79004 | 19,0 x 19,0 | 9,0 | 1,50 | ■ |
| 79005 | 19,0 x 19,0 | 9,0 | 1,50 | ■ |



Tablett „FRIENDLY TRAY“ tray bandeja plateau



friendly tray

vollständig recycelbar und 100% umweltschonend
 fully recyclable and 100% environmentally friendly
 totalmente reciclable y 100% respetuoso con el medio ambiente
 entièrement recyclable et 100% écologique

| | cm | ↑ cm | GN | Farbe / Colour |
|-------|-------------|------|-----|----------------|
| 79006 | 32,5 x 26,5 | 3 | 1/2 | ■ |
| 79007 | 32,5 x 26,5 | 3 | 1/2 | ■ |

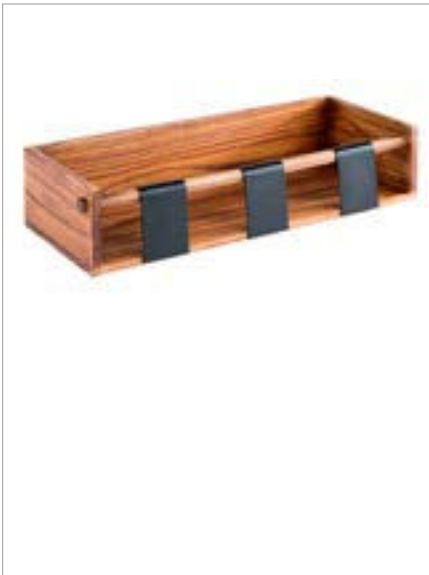

Dressingtopf-Display / -Station
 wooden station for 3 dressing pots
 expositor de madera para 3 salseras
 présentoir en bois pour 3 pots à sauce
inklusive 3 Beschriftungsschilder aus Metall
 including 3 metal labels
 con 3 etiquetas de metal
 avec 3 étiquettes métalliques



| | cm | ↑ cm |
|-------|---------|------|
| 84863 | 40 x 16 | 9 |



passend für 83311, 83867, 30060
 suitable for 83311, 83867, 30060



Dressingtopf „PASTELL“
 dressing pot
 salsera
 pot à sauce



| | cm | ↑ cm | ltr. | Farbe / Colour |
|-------|----|------|------|----------------|
| 84862 | 13 | 19,5 | 1,5 | Green |
| 84860 | 13 | 19,5 | 1,5 | Yellow |
| 84861 | 13 | 19,5 | 1,5 | Pink |

Beschriftungsetiketten, 72 Stück / labeling labels, 72 pcs. / etiquetas, 72 pzs / étiquettes, 72 pcs.

| | cm | Farbe / Colour |
|-------|---------|----------------|
| 00069 | 8 x 4,6 | Black |



mit Antirutschfüßchen
 with non-slip feet



stapelbar
 stackable



Dressingtopf „CASUAL“
 dressing pot
 salsera
 pot à sauce



| | cm | ↑ cm | ltr. | Farbe / Colour |
|-------|----|------|------|----------------|
| 83867 | 12 | 21,5 | 1 | White |
| 83868 | 12 | 21,5 | 1 | Black |



Dressingtopf
 dressing pot
 salsera
 pot à sauce



Deckel mit Löffelaussparung
 cover notched for spoon
 tapa agujereada para el cucharón
 couvercle avec espace pour la louche

| | Ø cm | ↑ cm | ltr. |
|-------|------|------|------|
| 83310 | 17,0 | 15 | 2,0 |
| 83311 | 13,0 | 13 | 0,8 |

BUFFET DISPLAY



Schale „ELEMENT“

bowl
cuenco
bol



| | Ø cm | ↑ cm | ltr. |
|-------|------|------------|------|
| 30000 | 22 | 6,0 / 10,5 | 1,1 |
| 30001 | 26 | 7,5 / 13,0 | 1,7 |
| 30002 | 29,5 | 8,5 / 14,5 | 2,5 |



möbelschonende Unterseite
furniture-friendly underside



Präsentationsmöglichkeiten
presentation example



Schale „COCONUT“

bowl
cuenco
bol



| | Ø cm | ↑ cm | ltr. |
|-------|------|------|------|
| 30020 | 18 | 9,5 | 1 |
| 30021 | 23 | 12,5 | 2,2 |



möbelschonende Unterseite
furniture-friendly underside



Buffetständer

buffet stand
expositor de buffet
présentoir buffet

Akazienholz
acacia wood
madera de acacia
bois d'acacia



| | Ø cm | ↑ cm |
|-------|------|------|
| 33255 | 15 | 10 |
| 33256 | 25 | 15 |

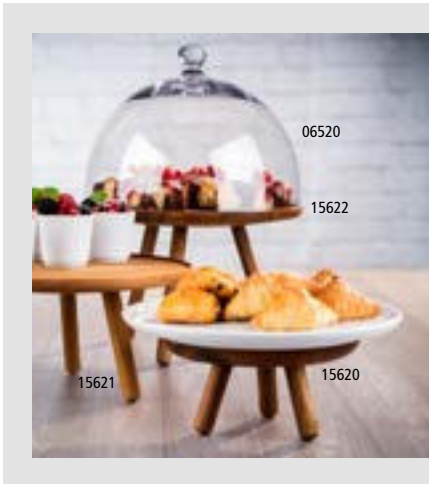

Buffetständer „ACACIA“

buffet stand
soporte para buffet
présentoir buffet

Akazienholz geölt / acacia wood oiled / madera de acacia aceitada / bois d'acacia huilé



| | Ø cm | ↑ cm |
|-------|------|------|
| 15620 | 20,0 | 10,5 |
| 15621 | 30,5 | 15,0 |
| 15622 | 30,5 | 20,0 |

Frischhaltehaube / cover / campana / cloche



| | Ø cm | ↑ cm | fits to |
|-------|------|------|--------------|
| 06520 | 30 | 22 | 15621, 15622 |

Frischhaltehaube / cover / campana / cloche



| | Ø cm | ↑ cm | fits to |
|-------|------|------|--------------|
| 06512 | 30 | 11,5 | 15621, 15622 |



Buffetständer „ACACIA“

buffet stand
soporte para buffet
présentoir buffet

Akazienholz geölt / acacia wood oiled / madera de acacia aceitada / bois d'acacia huilé



| | cm | ↑ cm | GN |
|-------|-----------|------|-----|
| 15623 | 53 x 16,2 | 20 | 2/4 |

GN Abdeckhaube / GN cover / GN campana/ GN cloche



| | cm | ↑ cm | GN |
|-------|-----------|------|-----|
| 11044 | 53 x 16,2 | 10,5 | 2/4 |

BUFFET DISPLAY

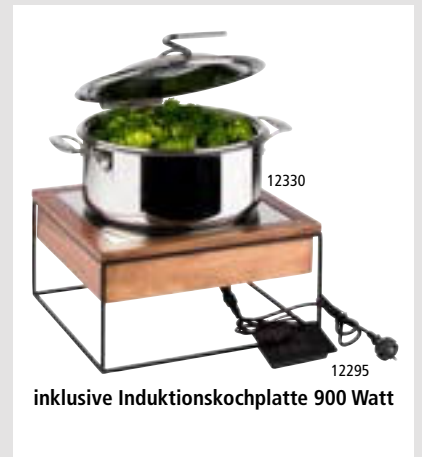

inklusive Induktionskochplatte 900 Watt

Die Induktionsstation mit Regler präsentiert sich in einem Set aus Walnussholz, einem schwarzen Metallständer und einer Induktionsheizung.

The induction station with controller is presented in a set of walnut wood, a black metal stand and an induction heater.

La estación de inducción con regulador se presenta en un set formado por una caja de madera de nogal, un soporte de metal negro y un calentador de inducción.

La station à induction avec température réglable se compose d'un caisson en bois noyer, d'un support métallique noir et d'une plaque à induction.



Induktionsstation, 4-teiliges Set

induction station, 4 pcs.
estación de inducción, set de 4
station d'induction, set de 4

4 teiliges Set:

- 1 Induktionskochplatte mit Regler (Ø 24 cm, 900 Watt)
- 1 Metallständer schwarz
- 1 Rahmen aus Walnussholz geölt
- 1 Edelstahlrahmen

4 pcs. set:

- 1 induction hotplate with controller (Ø 24 cm, 900 Watt)
- 1 metal stand black
- 1 frame in oiled walnut wood
- 1 stainless steel frame

set de 4:

- 1 placa de inducción con regulador (Ø 24 cm, 900 vatios)
- 1 soporte de metal negro
- 1 caja de madera de nogal aceitada
- 1 marco de acero inoxidable

set de 4:

- 1 plaque d'induction avec température réglable (Ø 24 cm, 900 watts)
- 1 support métallique noir
- 1 caisson en bois noyer huilé
- 1 cadre en acier inox



| | cm | ↑ cm |
|-------|-------------|------|
| 12270 | 35,4 x 32,5 | 19 |



passendes Chafing Dish Set 12330
suitable chafing dish set 12330

Ersatzteile / replacement parts / piezas de repuesto / pièces de rechange

| | cm | ↑ cm | |
|-------|-------------|------|---|
| 12271 | 35,4 x 32,5 | 8,5 | Holzrahmen / wooden frame |
| 12272 | 29,5 x 26,5 | 1 | Edelstahlrahmen / stainless steel frame |
| 12295 | Ø 24 | - | 900 Watt Induktionskochplatte / induction plate |
| 15506 | 35,4 x 32,5 | 17,6 | Buffetständer schwarz / buffet stand black |



Buffetleiter „BIG“

buffet ladder
dispensador en escalera
présentoir buffet en escalier



12-teiliges Set: 4 Glasschalen Ø 23 cm 2,5 Liter, 4 klappbare Schutzdeckel mit Beschriftungsfenster, 1 Leiter, 1 Doppelring, 2 Einzelringe, einfach und individuell zusammensetzbar

12 pcs. set: 4 glass bowls Ø 23 cm 2.5 litres, 4 hinged covers with card for inscription, 1 ladder, 1 double ring, 2 single rings, easy to fix and individual to use
set de 12: 4 cuencos de vidrio Ø 23 cm 2,5 l, 4 tapas abatibles con ventana para etiqueta, 1 soporte escalera, 1 aro doble, 2 aros sencillos, fácil de montar, posible usar individualmente
set de 12: 4 bols en verre Ø 23 cm 2,5 l, 4 couvercles à charnière et fenêtre pour étiquette, 1 support escalier, 1 cercle double, 2 cercles simples, montage facile, utilisable individuellement

| | cm | ↑ cm |
|-------|---------|------|
| 11598 | 39 x 31 | 66 |



Buffetleiter „BIG“

buffet ladder
dispensador en escalera
présentoir buffet en escalier



11-teiliges Set: 6 Glasschalen Ø 23 cm 2,5 Liter, 1 Leiter, 2 Doppelringe, 2 Einzelringe, einfach und individuell zusammensetzbar

11 pcs. set: 6 glass bowls Ø 23 cm 2.5 litres, 1 ladder, 2 double rings, 2 single rings, easy and individual to use
set de 11: 6 cuencos de vidrio Ø 23 cm 2,5 l, 1 soporte escalera, 2 aros dobles, 2 aros sencillos, fácil montar, se puede usar individualmente
set de 11: 6 bols en verre Ø 23 cm 2,5 l, 1 support escalier, 2 cercles doubles, 2 cercles simples, montage facile, utilisable individuellement

| | cm | ↑ cm |
|-------|---------|------|
| 11599 | 39 x 31 | 66 |

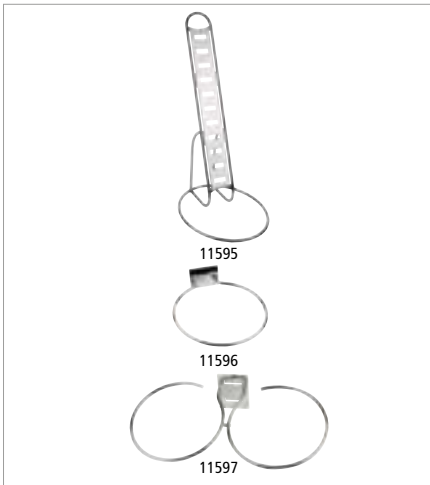

Einzelteile / spare parts / piezas de recambio / pièces détachées

Leitergestell / frame / marco solo / échelle support

| | cm | ↑ cm |
|-------|---------|------|
| 11595 | 39 x 31 | 66 |

Einzelring / single ring / aro sencillo / cercle simple

| | Ø cm |
|-------|------|
| 11596 | 23,5 |

Doppelring / double ring / aro doble / cercle double

| | cm |
|-------|-----------|
| 11597 | 48 x 23,5 |



Schale

bowl
cuenco
bol



| | Ø cm | ↑ cm | ltr. |
|-------|------|------|------|
| 11875 | 23 | 10,5 | 2,5 |



Schutzdeckel mit Löffelaussparung

cover
tapa
couvercle



| | Ø cm |
|-------|------|
| 11878 | 23,5 |

BUFFET DISPLAY



Buffetleiter „LITTLE“

buffet ladder
dispensador en escalera
présentoir buffet en escalier



12-teiliges Set: 4 Glasschalen Ø 14 cm 0,5 Liter, 4 klappbare Schutzdeckel mit Beschriftungsfenster, 1 Leiter, 1 Doppelring, 2 Einzelringe, einfach und individuell zusammensetzbar

12 pcs. set: 4 glass bowls Ø 14 cm 0.5 litres, 4 hinged covers with card for inscription, 1 ladder, 1 double ring, 2 single rings, easy and individual to use
set de 12: 4 cuencos de vidrio Ø 14 cm 0,5 l, 4 tapas abatibles con ventana para etiqueta, 1 soporte escalera, 1 aro doble, 2 aros sencillos, fácil montaje, se puede usar individualmente
set de 12: 4 bols en verre Ø 14 cm 0,5 l, 4 couvercles à charnière et fenêtre pour étiquette, 1 support escalier, 1 cercle double, 2 cercles simples, montage facile, utilisable individuellement

| | cm | ↑ cm |
|-------|---------|------|
| 11498 | 30 x 30 | 48 |



Buffetleiter „LITTLE“

buffet ladder
dispensador en escalera
présentoir buffet en escalier



11-teiliges Set: 6 Glasschalen Ø 14 cm 0,5 Liter, 1 Leiter, 2 Doppelringe, 2 Einzelringe, einfach und individuell zusammensetzbar

11 pcs. set: 6 glass bowls Ø 14 cm 0.5 litres, 1 ladder, 2 double rings, 2 single rings, easy and individual to use
set de 11: 6 cuencos de vidrio Ø 14 cm 0,5 l, 1 soporte escalera, 2 aros dobles, 2 aros sencillos, fácil montaje, se puede usar individualmente
set de 11: 6 bols en verre Ø 14 cm 0,5 l, 1 support escalier, 1 cercles doubles, 2 cercles simples, montage facile, utilisable individuellement

| | cm | ↑ cm |
|-------|---------|------|
| 11499 | 30 x 30 | 48 |

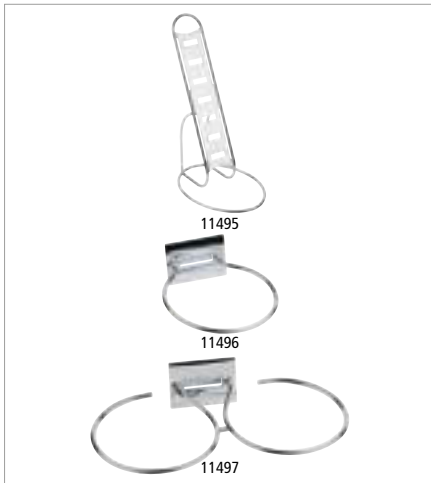

Einzelteile / spare parts / piezas de recambio / pièces détachées

Leitergestell / frame / marco solo / échelle support

| | Ø cm | ↑ cm |
|-------|------|------|
| 11495 | 30 | 48 |

Einzelring / single ring / aro sencillo / cercle simple

| | Ø cm |
|-------|------|
| 11496 | 14 |

Doppelring / double ring / aro sencillo / cercle double

| | cm | cm |
|-------|-------------|----|
| 11497 | 29,5 x 14,5 | 48 |



Schale

bowl
cuenco
bol



| | Ø cm | ↑ cm | ltr. | VE / unit |
|-------|------|------|------|-----------|
| 11865 | 14 | 6,5 | 0,5 | 6 |



Schutzdeckel mit Löffelaussparung

cover
tapa
couvercle



| | Ø cm |
|-------|------|
| 11868 | 14,5 |



7 tlg.
7 pcs.

Buffetgestell „SUNDAY“

buffet stand
expositor buffet
présentoir buffet



7-teiliges Set: 3 Glasschalen Ø 23 cm (2,5 Liter), 3 klappbare Schutzdeckel, 1 Gestell

7 pcs. set: 3 glass bowls Ø 23 cm (2,5 litres), 3 hinged covers, 1 stand
set de 7: 3 cuencos de cristal Ø 23 cm (2,5 l), 3 tapas con bisagra, 1 soporte
set de 7: 3 bols en verre Ø 23 cm (2,5 l), 3 couvercles à charnière, 1 support

| | cm | ↑ cm | |
|-------|---------|------|--|
| 11795 | 61 x 24 | 35 | |

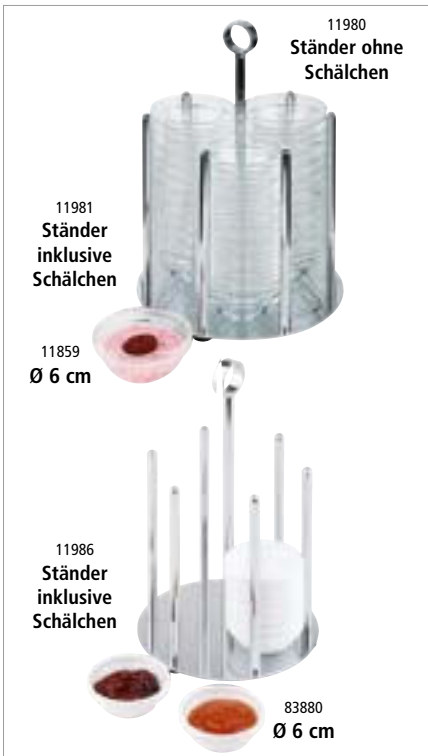

11980
Ständer ohne
Schälchen

11981
Ständer
inklusive
Schälchen

11859
Ø 6 cm

11986
Ständer
inklusive
Schälchen

83880
Ø 6 cm

Schälchenspender „MINI“

bowl holder
rack dispensador para cuencos
porte-bols



geeignet für Schalen Ø 6 cm, bestückbar mit bis zu 36 Schalen

for bowls Ø 6 cm, suitable for 36 bowls
para cuencos de Ø 6 cm, apto para 36 cuencos
pour bols de Ø 6 cm, pour 36 bols

| | Ø cm | ↑ cm | |
|-------|------|------|---|
| 11981 | 14 | 25,5 | Ständer inklusive 36 Glasschalen, Ø 6 cm frame with 36 bowls, Ø 6 cm |
| 11986 | 14 | 25,5 | Ständer inklusive 36 Melaminschalen, Ø 6 cm frame with 36 melamine bowls, Ø 6 cm |

Schälchenspender „MINI“ / bowl holder / rack dispensador para cuencos / porte-bols

| | Ø cm | ↑ cm | |
|-------|------|------|---|
| 11980 | 14 | 25,5 | Ständer ohne Schalen / frame without bowls soporte sin cuencos / support sans bols |



Serviergestell „WECK“

serving stand
expositor
présentoir



ohne Gläser
without glasses
sin tarros
sans verrines

| | Ø cm | ↑ cm | |
|-------|------|------|-------------|
| 33246 | 22 | 59 | 12 x Ø 6 cm |

passende Gläser / matching glasses / tarros adecuados / verrines appropriées

| | Ø cm | ↑ cm | ltr. | pcs |
|-------|------|------|------|-----|
| 82310 | 6 | 5,5 | 0,08 | 12 |
| 82312 | 6 | 7,0 | 0,14 | 12 |
| 82314 | 6 | 8,0 | 0,16 | 12 |

BUFFET LADDER GN



Buffetleiter „LITTLE GN 1/3“

buffet ladder
dispensador en escalera
présentoir buffet en escalier

4-teilig: 1 Leiter-Gestell, 3 GN 1/3 Rahmen

4 pcs.: 1 ladder, 3 single rings GN 1/3

set de 4: 1 soporte escalera, 3 aros sencillos GN 1/3

set de 4: 1 support escalier, 3 cercles simples GN 1/3



| | cm | ↑ cm | fits to |
|-------|-----------|------|-----------------------|
| 11526 | 31,5 x 32 | 48 | baskets / pans GN 1/3 |



Buffetleiter „LITTLE GN 1/2“

buffet ladder
dispensador en escalera
présentoir buffet en escalier

4-teilig: 1 Leiter-Gestell, 3 GN 1/3 Rahmen

4 pcs.: 1 ladder, 3 single rings GN 1/3

set de 4: 1 soporte escalera, 3 aros sencillos GN 1/3

set de 4: 1 support escalier, 3 cercles simples GN 1/3



| | cm | ↑ cm | fits to |
|-------|-------------|------|-----------------------|
| 11527 | 31,5 x 41,5 | 48 | baskets / pans GN 1/2 |

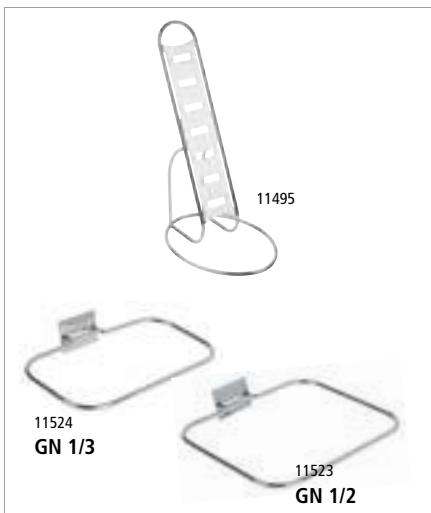

Einzelteile / spare parts / piezas sueltas / pièces détachées

Leitergestell / frame / marco de escalera / échelle support

11495

Einzelring GN 1/3 / single ring GN 1/3 / aro sencillo GN 1/3 / cercle simple GN 1/3

11524

Einzelring GN 1/2 / single ring GN 1/2 / aro sencillo GN 1/2 / cercle simple GN 1/2

11523



2x 84304
GN 1/4

1x 83757
GN 1/2

1x 83757
GN 1/2

1x 83757
GN 1/2

4 tlg.
4 pcs.

Buffetleiter „BIG GN 1/2“
buffet ladder
dispensador en escalera
présentoir buffet en escalier

5-teilig: 1 Leiter-Gestell, 4 GN 1/2 Rahmen
5 pcs.: 1 ladder, 4 single rings GN 1/2
set de 5: 1 soporte escalera, 4 aros sencillos GN 1/2
set de 5: 1 support escalier, 4 cercles simples GN 1/2

| | cm | ↑ cm | fits to |
|-------|-----------|------|-----------------------|
| 11528 | 31,5 x 56 | 66 | baskets / pans GN 1/2 |

METALL
VERCHROMT

3x 83753
GN 1/3

2x 83757
GN 1/2

1x 83759
GN 1/1

4 tlg.
4 pcs.

Buffetleiter „BIG GN 1/1“
buffet ladder
dispensador en escalera
présentoir buffet en escalier

4-teilig: 1 Leiter-Gestell, 3 GN 1/1 Rahmen
4 pcs.: 1 ladder, 3 single rings GN 1/1
set de 4: 1 soporte escalera, 3 aros sencillos GN 1/1
set de 4: 1 support escalier, 3 cercles simples GN 1/1

| | cm | ↑ cm | fits to |
|-------|---------|------|-----------------------|
| 11529 | 52 x 59 | 66 | baskets / pans GN 1/1 |

METALL
VERCHROMT

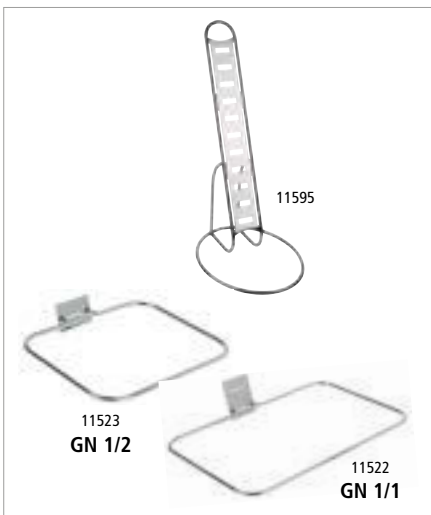

Einzelteile / spare parts / piezas sueltas / pièces détachées

Leitergestell / frame / marco de escalera / échelle support

11595

Einzelring GN 1/2 / single ring GN 1/2 / aro sencillo GN 1/2 / cercle simple GN 1/2

11523

Einzelring GN 1/1 / single ring GN 1/1 / aro sencillo GN 1/1 / cercle simple GN 1/1

11522

ETAGERES

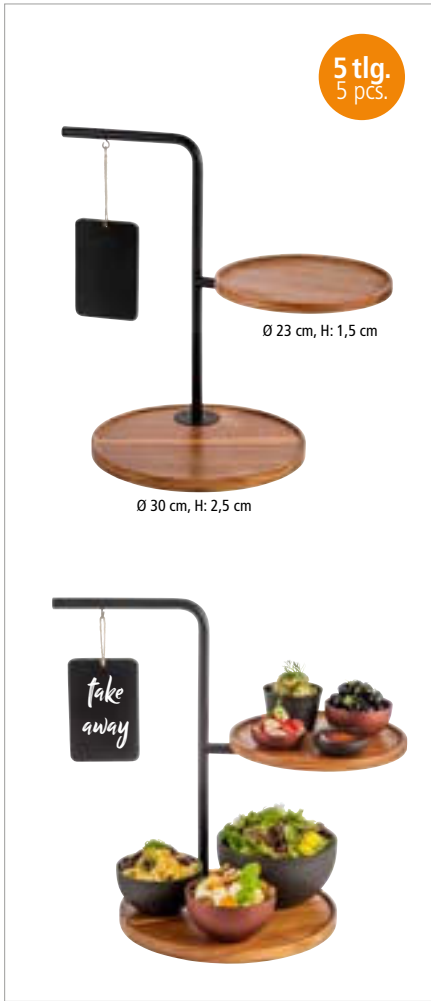

2-stufige Etagère „IRON“

2-tier tray
bandeja con dos alturas
étagère carré 2 hauteurs

- 1 Gestell aus schwarzem Metall
- 2 Akazienholzplatten: Ø 23 cm, H: 1,5 cm / Ø 30 cm, H: 2,5 cm
- 2 Beschriftungsschilder 15 x 10,5 cm

- 1 soporte metálico negro
- 2 tablas de madera de acacia: Ø 23 cm, H: 1,5 cm / Ø 30 cm, H: 2,5 cm
- 2 etiquetas de inscripción 15 x 10,5 cm

- 1 support métallique noir
- 2 panneaux en bois d'acacia: Ø 23 cm, H: 1,5 cm / Ø 30 cm, H: 2,5 cm
- 2 étiquettes d'inscription 15 x 10,5 cm



| | cm | ↑ cm |
|-------|---------|------|
| 30334 | 47 x 30 | 44 |

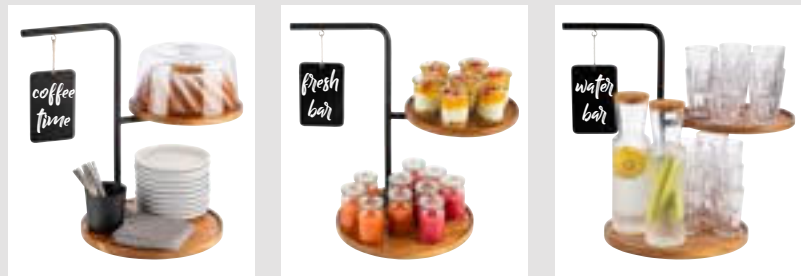

Präsentationsmöglichkeiten
presentation examples



2-stufige Etagère

2-tier tray
soporte 2 alturas
étagère 2 niveaux

- 1 Gestell aus Metall schwarz, mit Antirutschfüßchen,
- 2 herausnehmbare Bretter aus geöltem Akazienholz (34,5 x 20,5 x 1,5 cm) / (34,5 x 13 x 1,5 cm)
- 8 Beschriftungsschilder (8 x 4 cm)

- 1 frame made of black metal with non-slip feet,
- 2 removable trays made of acacia wood (34,5 x 20,5 x 1,5 cm) / (34,5 x 13 x 1,5 cm)
- 8 labelling plates (8 x 4 cm)

- 1 soporte metálico, negro con pies antideslizantes,
- 2 bandejas extraíbles de madera de acacia (34,5 x 20,5 x 1,5 cm) / (34,5 x 13 x 1,5 cm)
- 8 etiquetas (8 x 4 cm)

- 1 support métallique noir avec pieds antidérapants,
- 2 planches amovibles en bois d'acacia (34,5 x 20,5 x 1,5 cm) / (34,5 x 13 x 1,5 cm)
- 8 étiquettes (8 x 4 cm)



| | cm | ↑ cm |
|-------|-----------|------|
| 30339 | 35,5 x 21 | 40 |

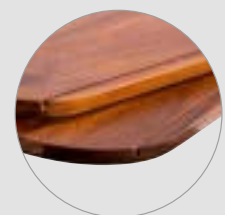

Präsentationsmöglichkeiten
presentation examples

mit Antirutschfüßchen
with non-slip feet

geöltes Akazienholz
oiled acacia wood



1 x Gestell / 1 x frame



2 x Korb / 2 x basket

5 tlg.
5 pcs.



2 x Tablett / 2 x tray



Haube / cover 11056



Korb / basket 30337



NEW

Tablett / tray 85099



Tablett / tray 30338

2-stufige Etagère „ALL-ROUNDER“, 5-teilig

2-tier tray, 5 pcs.

soporte 2 alturas, set de 5

étagère 2 niveaux, set de 5

5 teiliges Set:

- 1 Gestell aus Metall schwarz, mit Antirutschfüßchen,
- 2 Körbe aus Metall schwarz je 29 x 16 cm, H: 7 cm,
- 2 herausnehmbare Bretter aus geöltem Akazienholz je 28,5 x 15,5 cm, H: 1,5 cm

5 pcs.:

- 1 frame made of black metal with non-slip feet,
- 2 removable baskets of black metal each 29 x 16 cm, H: 7 cm,
- 2 boards of oiled acacia wood each 28,5 x 15,5 cm, H: 1,5 cm

set de 5:

- 1 soporte metálico, negro con pies antideslizantes,
- 2 cestas metálicas negras, cada una de 29 x 16 cm, H: 7 cm,
- 2 tablas de madera de acacia aceiteada 28,5 x 15,5 cm, H: 1,5 cm

set de 5:

- 1 support métallique noir avec pieds antidérapants,
- 2 paniers métalliques noirs, chacune 29 x 16 cm, H: 7 cm,
- 2 planches d'acacia huilé, chacune 28,5 x 15,5 cm, H: 1,5 cm



| | cm | ↑ cm |
|-------|---------|------|
| 30336 | 31 x 17 | 37,5 |



multifunktional,
ideal als

- Frühstück-Etagère
- Vorspeisen-Etagère
- Kuchen-Etagère
- Brot-Etagère
- Gebäck-Etagère
- Früchte-Etagère

Präsentationsmöglichkeiten
presentation examples



geöltes Akazienholz
oiled acacia wood



mit Antirutschfüßchen
with non-slip feet

Korb / basket / cesta / corbeille

| | cm | ↑ cm | Farbe / Colour |
|-------|---------|------|----------------|
| 30337 | 29 x 16 | 7 | ■ |

Servierbrett aus Akazienholz / serving board of acacia wood / tabla de servio de madera de acacia / planche de service en bois d'acacia

| | cm | ↑ cm | Farbe / Colour |
|-------|-------------|------|----------------|
| 30338 | 28,5 x 15,5 | 3,5 | ■ |

Melamintablett / melamine tray / bandeja de melamina / plateau en mélamine

| | cm | ↑ cm | Farbe / Colour |
|-------|-------------|------|----------------|
| 85099 | 28,0 x 15,5 | 1,0 | ■ |

Haube / cover / campana / cloche

| | cm | ↑ cm |
|-------|-------------|------|
| 11056 | 26,0 x 12,0 | 10,0 |

ETAGERES



GN 1/3

GN 1/2

3 tlg.
3 pcs.

Serviergestell, 2-stufig

serving stand, 2-tier
soporte platos, 2 alturas
présentoir, 2 hauteurs

3 tlg. Set: 1 Gestell aus Akazienholz, 2 Schieferplatten, zusammenklappbar

3 pcs.: 1 stand acacia wood, 2 slate trays, foldable

set de 3: 1 soporte madera de acacia, 2 bandejas de pizarra, plegable

set de 3: 1 présentoir en bois d'acacia, 2 plateaux en ardoise naturelle, pliable



zusammenklappbar
foldable

| | cm | ↑ cm |
|-------|------|-----------|
| 00958 | 36,5 | 34 x 26,5 |



High Tea Rack

High Tea Rack
rack de té alto
étagère à thé avec anse supérieure

Rubberwood dunkelbraun, Edelstahlgriff, 4 große Fächer 15 x 10 x 10 cm,
3 kleine Fächer 9,5 x 9,5 x 10 cm

rubber wood in dark brown, stainless handle, 4 big compartments 15 x 10 x 10 cm, 3 small compartments 9,5 x 9,5 x 10 cm

madera marrón oscura, mango de acero inoxidable, 4 compartimentos grandes 15 x 10 x 10 cm, 3 compartimentos pequeños 9,5 x 9,5 x 10 cm

bois marron foncé, poignée en acier inox, 4 compartiments grands 15 x 10 x 10 cm, 3 compartiments petits 9,5 x 9,5 x 10 cm



| | cm | ↑ cm |
|-------|---------|------|
| 33210 | 34 x 10 | 38 |



Hygieneschutz
11557 / 11558

79553

Brezel- oder Wurstständer

pretzel-/ sausage stand
soporte para pretzels/ embutidos
support à bretzel ou à saucissons

Verkaufsständer Buchenholz versiegelt, bestens geeignet für die Präsentation von Brezeln,
Würstchen, etc., Fuß Ø 22 cm

beech wood, ideal to present pretzels, sausages, etc., , base Ø 22 cm

soporte de madera de haya, ideal para presentar pretzels, salchicas, etc., base Ø 22 cm

support en bois de hêtre, pour la présentation de bretzels, saucisses, etc. pied Ø 22 cm



| | Ø cm | ↑ cm |
|-------|------|------|
| 79553 | 28 | 50 |

Hygieneschutz für Brezelständer / hygienic cover / campana higiénica antialiento / pare-haleine

| | cm | ↑ cm |
|-------|--------------|------|
| 11557 | 20 x 20 x 20 | 50 |
| 11558 | 15 x 20 x 15 | 50 |



inklusive Haube
including cover

Hobel für Käse und Schokolade

cheese / choco curler
rizador para queso y chocolate
frisette pour fromage et chocolat

3-teilig: Platte Buchenholz versiegelt Ø 22 cm mit senkrechtem Stift

+ Hobel 7 cm + Haube Ø 15 x 10 cm, für Käse und Schokolade

3 pcs.: wooden base Ø 22 cm with vertical bolt + plough 7 cm
+ cover Ø 15 x 10 cm, for cheese and chocolate

set de 3: base de madera Ø 22 cm, con eje vertical de 7 cm

+ campana Ø 15 x 10 cm, para „rizar“ queso y chocolate

set de 3: base bois Ø 22 cm, axe vertical ht. 7 cm, cloche Ø 15 x ht 10 cm,

pour „friser“ le fromage ou le chocolat



| | Ø cm | ↑ cm |
|-------|------|------|
| 50002 | 22 | 15 |

SERVING STANDS



2-stufige Etagère 2-tier étagère cesta doble 2 alturas étagère 2 paniers



Griff aus Holz, Körbe aus Metall schwarz,
oberer Korb (Ø 22 cm, H: 6 cm), unterer Korb (Ø 26 cm, H: 8 cm)

wooden handle, baskets made of metal black,
upper basket (Ø 22 cm, H: 6 cm), lower basket (Ø 26 cm, H: 8 cm)

asa de madera, cestas de metal negro,
cesta superior (Ø 22 cm, H: 6 cm), cesta inferior (Ø 26 cm, H: 8 cm)

manche en bois, corbeilles en métal noir,
corbeille supérieure (Ø 22 cm, H: 6 cm), corbeille inférieure (Ø 26 cm, H: 8 cm)

| | Ø cm | ↑ cm |
|-------|------|------|
| 30335 | 26 | 48 |



Präsentationsmöglichkeiten
presentation examples

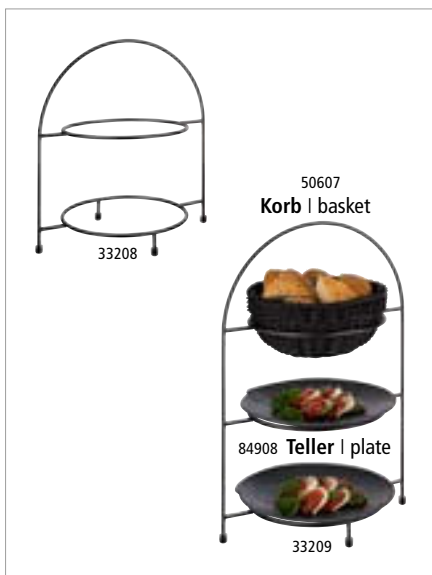

Serviergestell „INDUSTRIAL“ serving stand soporte platos présentoir à assiettes



für Teller max. Ø 27 cm, innerer Ring Ø 18 cm, Lieferung ohne Teller
for plates max. Ø 27 cm, circle inside Ø 18 cm, delivery without dishes
para platos máx. Ø 27 cm, aro interior Ø 18 cm, se entrega sin platos
pour assiettes Ø 27 cm maxi., anneau intérieur Ø 18 cm, livré sans assiettes

| | cm | ↑ cm | passend für Tellerabdeckhauben / suitable for plate covers |
|-------|-----------|------|---|
| 33208 | 29 x 19,5 | 30 | 2 Teller Ø 27 cm innerer Ring Ø 18 cm |
| 33209 | 29 x 19,5 | 43 | 3 Teller Ø 27 cm innerer Ring Ø 18 cm |



Serviergestell

serving stand
soporte platos
présentoir à assiettes



für 3 Teller max. Ø 27 cm, innerer Ring Ø 18 cm
for 3 plates max. Ø 27 cm, circle inside Ø 18 cm
para 3 platos Ø 27 cm, aro interior Ø 18 cm
pour 3 assiettes maxi Ø 27 cm, anneau intérieur Ø 18 cm

| | cm | ↑ cm |
|-------|---------|------|
| 33217 | 33 x 24 | 43 |

für 2 Teller max. Ø 27 cm, innerer Ring Ø 18 cm, Lieferung ohne Teller
for 2 plates max. Ø 27 cm, circle inside Ø 18 cm, without dishes
para 2 platos Ø 27 cm, aro interior Ø 18 cm, se entrega sin platos
pour 2 assiettes maxi Ø 27 cm, anneau intérieur Ø 18 cm, livré sans assiettes

| | cm | ↑ cm |
|-------|-----------|------|
| 33214 | 33 x 23,5 | 30 |

für 3 Teller max. Ø 17 cm, innerer Ring Ø 10,5 cm
for 3 plates max. Ø 17 cm, circle inside Ø 10,5 cm
para 3 platos Ø 17 cm, aro interior Ø 10,5 cm
pour 3 assiettes maxi Ø 17 cm, anneau intérieur Ø 10,5 cm

| | cm | ↑ cm |
|-------|-------------|------|
| 33216 | 22,5 x 16,5 | 25,5 |



Serviergestell

serving stand
soporte platos
présentoir à assiettes



für 3 Teller max. Ø 17 cm, innerer Ring Ø 10,5 cm
for 3 plates max. Ø 17 cm, circle inside Ø 10,5 cm
para 3 platos Ø 17 cm, aro interior Ø 10,5 cm
pour 3 assiettes maxi Ø 17 cm, anneau intérieur Ø 10,5 cm

| | cm | ↑ cm | Farbe / Colour |
|-------|-------------|------|----------------|
| 33215 | 18,5 x 15,5 | 26 | chrome |
| 33211 | 18,5 x 15,5 | 26 | copper |

für 3 Teller max. Ø 27 cm, innerer Ring Ø 18 cm
for 3 plates max. Ø 27 cm, circle inside Ø 18 cm
para 3 platos Ø 27 cm, aro interior Ø 18 cm
pour 3 assiettes maxi Ø 27 cm, anneau intérieur Ø 18 cm

| | cm | ↑ cm | Farbe / Colour |
|-------|-----------|------|----------------|
| 33220 | 29 x 19,5 | 43 | chrome |
| 33212 | 29 x 19,5 | 43 | copper |

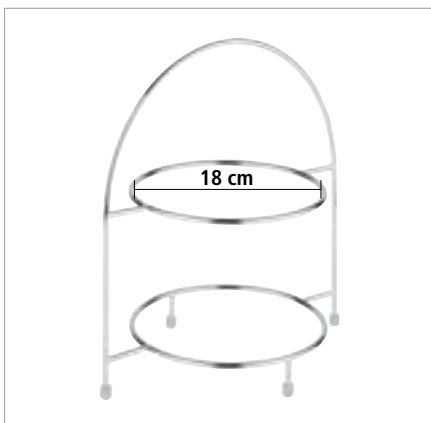

Serviergestell

serving stand
soporte platos
présentoir à assiettes



für 2 Teller max. Ø 27 cm, innerer Ring Ø 18 cm
for 2 plates max. Ø 27 cm, circle inside Ø 18 cm
para 2 platos Ø 27 cm, aro interior Ø 18 cm
pour 2 assiettes maxi Ø 27 cm, anneau intérieur Ø 18 cm

| | cm | ↑ cm | Farbe / Colour |
|-------|-----------|------|----------------|
| 33219 | 29 x 19,5 | 30 | chrome |



Etagère „FINESSE“

etagère
frutero
étagère



vergoldeter Messing-Kugelgriff, einfache Montage

gold plated knob, easy to assemble

botón dorado, fácil de montar

bouton doré, montage facile

| | Ø cm | ↑ cm | |
|-------|--------------|------|--|
| 33248 | 48 / 38 / 32 | 50 | 3-stufig / 3-tier 3 alturas / 3 niveaux |
| 33238 | 38 / 32 | 30 | 2-stufig / 2-tier 2 alturas / 2 niveaux |



Etagère

etagère
frutero
corbeille à fruits



ergonomischer Griff, stehend auf schwarzen Antirutsch-Füßen

ergonomic handle, with non-slip feet

asa ergonómica, con pies antideslizantes color negro

anse ergonomique, avec pieds antidérapants noirs

| | cm | ↑ cm |
|-------|---------|------|
| 30325 | 30 x 30 | 35,5 |



3-stufige Etagère

3-tier tray
bandeja con tres alturas
étagère carré 3 hauteurs



Naturschieferplatte, Akazienholz

natural slate tray, wood akazie

bandeja de pizarra natural, madera de acacia

plateau ardoise naturelle, bois d'acacia

| | Ø cm | ↑ cm | * mm |
|-------|--------------|------|-------|
| 00960 | 30 / 25 / 20 | 34 | 6 - 9 |

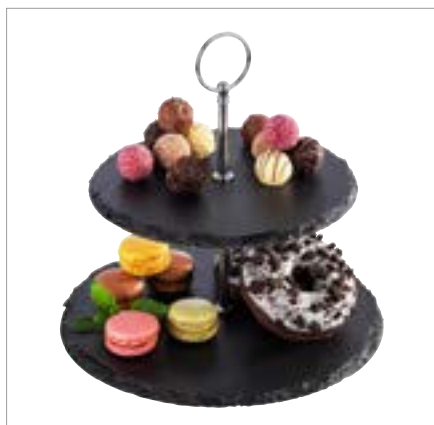

2-stufige Etagère

2-tier tray
bandeja dos alturas
étagère carré 2 hauteurs



Naturschiefer

natural slate tray

bandeja de pizarra natural

plateau ardoise naturelle

| | Ø cm | ↑ cm | * mm |
|-------|---------|------|-------|
| 00989 | 25 / 20 | 24 | 6 - 9 |

CUTTING BOARDS



00954
Box

00953
Schneidebrett

83615
Tablett



Tablett „BROTSTATION“

tray
bandeja
plateau

mit Antirutschfüßchen
with non-slip feet
con pies antideslizantes
avec pieds antidérapants



cm ↑ cm

83615 59,5 x 35,5 3,5

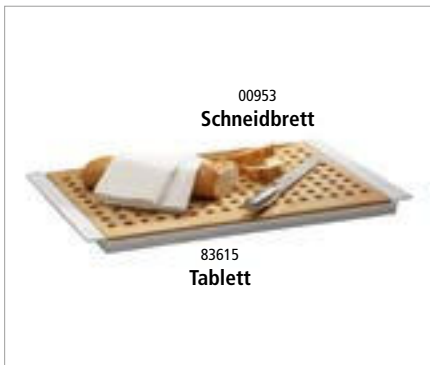

00953
Schneidebrett

83615
Tablett

Brotschneidebrett „BROTSTATION“

cutting board
tabla de corte
planche à découper

Buchenholz
beech
haya
hêtre



cm ↑ cm

00953 52 x 34 2

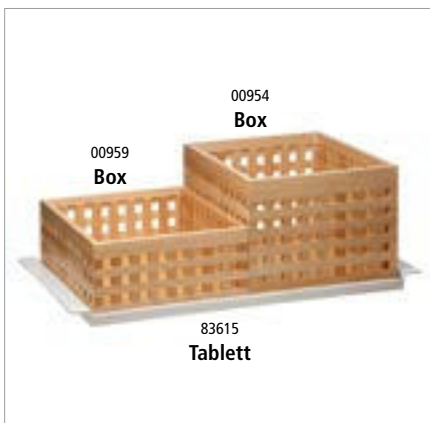

00954
Box

83615
Tablett

Box „BROTSTATION“

box
caja de pan
boîte à pain

Buchenholz
beech
haya
hêtre



cm ↑ cm

00959 34 x 26 12,5
00954 34 x 26 20,0



Brotschneidebrett „PROFI“

cutting board
tabla de cortar
planche à découper



Eichenholz / oak wood / mader de roble / bois de chêne

| | cm | ↑ cm | |
|-------|-----------|------|--|
| 00806 | 58 x 37,5 | 4 | |



Brotschneidebrett

cutting board
tabla de cortar
planche à découper



Walnussholz / walnut wood / mader de nogal / bois de noyer

| | cm | ↑ cm | GN |
|-------|-------------|------|-----|
| 00911 | 35,4 x 32,5 | 3,5 | 2/3 |



praktisches Krümfach
practical crump shelf



praktisches Krümfach
practical crump shelf

Brotschneidebrett „LETTER“

cutting board
tabla de cortar
planche à découper



Akazienholz / acacia wood / mader de acacia / bois d'acacia

| | cm | ↑ cm | |
|-------|---------|------|--|
| 00886 | 48 x 34 | 3,5 | |



00885

Brotschneidebrett

cutting board
tabla de cortar
planche à découper



Akazienholz / acacia wood / mader de acacia / bois d'acacia

| | cm | ↑ cm | GN |
|-------|-------------|------|-----|
| 00883 | 47,5 x 32,0 | 2 | |
| 00884 | 53,0 x 32,5 | 2 | 1/1 |
| 00885 | 60,0 x 40,0 | 2 | |



praktisches Krümfach
practical crump shelf



00957

Brotschneidebrett

cutting board
tabla de cortar
planche à découper



Rubberwood / rubberwood / mader de caucho / bois d'hévéa

| | cm | ↑ cm | GN |
|-------|-------------|------|-----|
| 00955 | 47,5 x 32,0 | 2 | |
| 00956 | 53,0 x 32,5 | 2 | 1/1 |
| 00957 | 60,0 x 40,0 | 2 | |



praktisches Krümfach
practical crump shelf

BUFFET GUARD

3 Höhen einstellbar
3 heights adjustable

Servierbeispiel
presentation example



schwenkbar
swivelling



Hygieneschutz „BUFFET GUARD“

sneeze guard
protector anti aliento
pare-haleine



- transparente, höhenverstellbare Acrylplatte 80 x 53 cm
- Neigungswinkel stufenlos einstellbar
- transparent, height-adjustable acrylic plate 80 x 53 cm
- tilt angle continuously adjustable
- placa acrílica transparente y de altura ajustable 80 x 53 cm
- el ángulo de inclinación es infinitamente variable
- plaque en acrylique transparente 80 x 53 cm et réglable en hauteur
- angle d'inclinaison variable à l'infini

| | cm | ↑ cm | mm | Fuß / base |
|-------|---------|------|----|------------------------------|
| 98120 | 93 x 53 | 50,5 | 5 | Metall schwarz / metal black |



Antirutschfüßchen
non-slip feet



Der Neigungswinkel der Acrylplatte ist flexibel einstellbar
the angle of inclination of the acrylic plate is flexibly adjustable

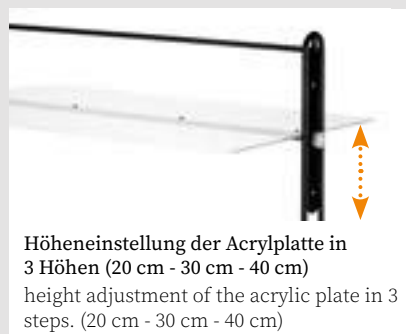

Höheneinstellung der Acrylplatte in 3 Höhen (20 cm - 30 cm - 40 cm)
height adjustment of the acrylic plate in 3 steps. (20 cm - 30 cm - 40 cm)



Schalen / bowls 25 x 25 cm
6 x 83918
Anwendungsbeispiel
application example



Lieferung erfolgt demontiert
delivery takes place disassembled

DRAWER SET



3 tlg.
3 pcs.



mit Antirutsch Füßchen
with non-slip feet



Schubladen Set, 3-teilig

drawer set, 3 pcs.
cajonera, set de 3
set tiroir, set de 3

3-teiliges Set:

- 1 Ständer aus Metall schwarz
- 1 Schublade mit Griff schwarz
- 1 Schneidebrett aus geöltem Walnussholz

3 pcs. set:

- 1 stand made of metal black
- 1 drawer with handle black
- 1 oiled walnut wood cutting board

set de 3:

- 1 soporte de metal negro
- 1 cajón con asa negra
- 1 tabla de cortar de madera de nogal engrasada

set de 3:

- 1 support métallique noir
- 1 tiroir avec poignée noire
- 1 planche à découper en bois de noyer huilé



| | cm | ↑ cm |
|-------|-------------|------|
| 00910 | 35,4 x 32,5 | 20 |



Anwendungsbeispiele
application examples

Einzelteile / parts / piezas / pièces

| | cm | ↑ cm | |
|-------|-------------|------|--|
| 00911 | 35,4 x 32,5 | 3,5 | Schneidebrett / cutting board |
| 00912 | 34,0 x 32,0 | 17,5 | Schublade, Griff schwarz / drawer, handle black |
| 00914 | 34,0 x 32,0 | 17,5 | Schublade, Griff chrom / drawer, handle chrome |
| 15503 | 35,4 x 32,5 | 17,6 | GN Buffetständer chrom / GN buffet stand chrome |
| 15506 | 35,4 x 32,5 | 17,6 | GN Buffetständer schwarz / GN buffet stand black |

SNACKPRESENTER



Snackpresenter

snackpresenter
dispensador de bocadillos
présentoir à sandwiches
mit Safrille und Griffmulde, passend für Vitrine 11888
with recessed grip, suitable for showcase 11888
asa moldeada, apto para la vitrina 11888
anse moulée, apte pour vitrine 11888



| | cm | ↑ cm | |
|-------|---------|------|---|
| 11887 | 29 x 19 | 6,5 | 3 Mulden / 3 compartments 3 compartimentos / 3 compartiments |
| 11889 | 60 x 19 | 7,5 | 6 Mulden / 6 compartments 6 compartimentos / 6 compartiments |

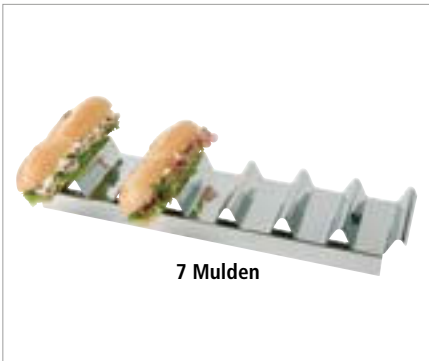

Snackpresenter

snackpresenter
dispensador de bocadillos
présentoir à sandwiches
hochglanzpoliert, mit Griffmulde, für 7 Baguettes
mirror polished, with recessed grip, for 7 baguettes
pulido brillante, con asa empotrada, ideal para 7 bocadillos
poli brillant, avec poignée encastrée, parfait pour 7 sandwiches



| | cm | ↑ cm |
|-------|-------------|------|
| 11891 | 47,5 x 10,5 | 6 |

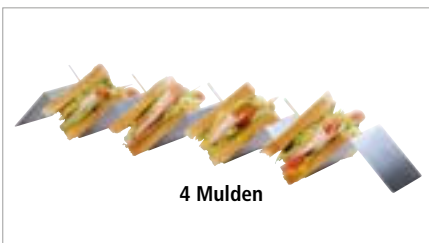

Snackpresenter

snackpresenter
dispensador de bocadillos
présentoir à sandwiches



| | cm | ↑ cm |
|-------|--------|------|
| 11969 | 56 x 8 | 5,5 |



Vitrine / Thekenaufsatz

showcase
vitrina de mostrador
vitrine de comptoir
rutschfest, aus einem Teil gefertigt
non-slip, monoblock produced
antideslizante, fabricado en 1 pieza
antidérapante, fabriquée en une seule pièce



| | cm | ↑ cm |
|-------|-----------|------|
| 11888 | 63,5 x 25 | 25 |



Hygieneschutz
hygienic cover
campana higiénica antialiento
pare-haleine



| | cm | ↑ cm |
|-------|---------|------|
| 11556 | 82 x 42 | 45 |



Brötchenspender
roll dispenser
dispensador de panecillos
distributeur de petits pains



hygienisch und einfach zu reinigen, mit Krümelschale
hygienic and easy to clean, with crumb tray
higiénico y fácil de limpiar, con bandeja para migas
hygiénique et facile à laver, avec plat ramasse-miettes

| | cm | ↑ cm | |
|-------|-------------|------|---|
| 11572 | 32,5 x 27,5 | 42 | für ca. 45-50 Brötchen / for approx. 45-50 rolls para 45-50 panecillos / pour 45-50 petits pains |
| 11573 | 32,5 x 27,5 | 56 | für ca. 65-70 Brötchen / for approx. 65-70 rolls para 65-70 panecillos / pour 65-70 petits pains |



Buffetgestell
buffet stand
soporte para buffet
présentoir buffet



3-stufig, Rubberwood, geeignet für Körbe, platzsparend zusammenklappbar
3-tier, rubberwood, usable for baskets, can be pushed together for place saving
3 alturas, madera de caucho, apto para cestas, se puede plegar para ahorrar espacio
3 hauteurs, bois d'hévéa, pour corbeilles, la structure s'ouvre ou se ferme pour réduire l'encombrement

| | cm | ↑ cm |
|-------|-----------|------|
| 33232 | 59 x 30,5 | 59 |

Tisch- und Buffetkorb, rund „ECONOMIC“ / buffet basket, round / cesta de buffet redonda / corbeille de buffet ronde

| | Ø cm | ↑ cm | Farbe / Colour |
|-------|------|------|----------------|
| 40144 | 39,0 | 10,0 | |



Buffetgestell, 3-teilig
buffet stand, 3 pcs.
expositor de buffet, set de 3
présentoir buffet, set de 3



Rubberwood, 3-teilig:
1. Fach 40 x 40 cm x H 33 cm;
2. Fach 40 x 37 cm x H 20 cm;
3. Fach 40 x 34 cm x H 9 cm

rubberwood, 3 pcs.:
1. 40 x 40 cm x H 33 cm;
2. 40 x 37 cm x H 20 cm;
3. 40 x 34 cm x H 9 cm

| | cm | ↑ cm | Farbe / Colour | Wenge |
|-------|---------|------|----------------|-------|
| 11607 | 40 x 40 | 33 | | |



Neigungswinkel stufenlos einstellbar
inclination angle continuously adjustable

für 3 versch. Haubengrößen
for 3 different cover sizes

06519 Ø 21 cm
06520 Ø 30 cm
06521 Ø 36 cm



Haubenthalterung „FLEXIBLE“

cover holder
soporte de la campana
support de la cloche



Bei dieser Haubenthalterung wird die Haube am Griff in die Vorrichtung gesteckt.
Für APS-Hauben geeignet!

With this cover holder, the cover is inserted into the device by the handle.
Suitable for APS covers!

Con este soporte de campana, la campana se cuelga simplemente por el asa.
¡Para campanas de APS!

Avec ce support, la cloche s'accroche simplement par la poignée.
Pour cloches APS!

| | cm | ↑ cm |
|-------|-----------|------|
| 33288 | 35,5 x 30 | 39 |



Anwendungsbeispiele
application examples

2 tlg.
2 pcs.



24 cm

Haube | cover
Ø 16 cm

Tablett | tray
Ø 18,5 cm



Tablett mit Haube

tray with cover
bandeja con campana
plateau avec cloche

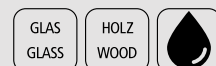

2 teiliges Set:

- 1 Tablett aus geöltem Buchenholz (Ø 18,5 cm, H: 2,5 cm)
- 1 Glas-Haube (Ø 16 cm, H: 22,5 cm)

2 pcs.:

- 1 tray of oiled beech wood (Ø 18,5 cm, H: 2,5 cm)
- 1 glass cover (Ø 16 cm, H: 22,5 cm)

set de 2:

- 1 bandeja de madera de haya (Ø 18,5 cm, H: 2,5 cm)
- 1 campana de cristal (Ø 16 cm, H: 22,5 cm)

set de 2:

- 1 plateau de bois de hêtre (Ø 18,5 cm, H : 2,5 cm)
- 1 couvercle en verre (Ø 16 cm, H : 22,5 cm)

| | Ø cm | ↑ cm |
|-------|------|------|
| 00830 | 18,5 | 24 |



Präsentationsmöglichkeit
presentation example



3 tlg.
3 pcs.

Multi Rack
multi rack
dispensador en escalera
support multiple



2-stufig, 3-teilig:

- 1 Gestell matt poliert
- 2 Schütten aus transparent gefroretetem Kunststoff, je ca. 1 Liter

2-tier, 3 pcs.:

- 1 frame matt polished
- 2 bowls frosted plastic, approx. 1 liter

2 alturas - set de 3:

- 1 soporte pulido mate
- 2 cuencos de plástico glaseado, aprox. 1 litro

2 niveaux - set de 3:

- 1 support poli mat
- 2 bols en plastique mat, approx. 1 litre

| | cm | ↑ cm |
|-------|---------|------|
| 11442 | 19 x 24 | 28 |



4 tlg.
4 pcs.

Multi Rack
multi rack
dispensador en escalera
support multiple



3-stufig, 4-teilig:

- 1 Gestell matt poliert
- 3 Schütten aus transparent gefroretetem Kunststoff, je ca. 1 Liter

3-tier, 4 pcs.:

- 1 frame matt polished
- 3 bowls frosted plastic, approx. 1 liter

3 alturas, set de 4:

- 1 soporte pulido mate
- 3 cuencos de plástico glaseado, aprox. 1 litro

3 niveaux - set de 4:

- 1 support poli mat
- 3 bols en plastique mat, approx. 1 litre

| | cm | ↑ cm |
|-------|---------|------|
| 11444 | 19 x 24 | 41 |



4 tlg.
4 pcs.

Multi Rack
multi rack
dispensador en escalera
support multiple



4-stufig, 5-teilig:

- 1 Gestell matt poliert
- 4 Schütten aus transparent gefroretetem Kunststoff, je ca. 1 Liter

4-tier, 5 pcs.:

- 1 frame matt polished
- 4 bowls frosted plastic, approx. 1 liter

4 alturas, set de 5:

- 1 soporte pulido mate
- 4 cuencos de plástico glaseado, aprox. 1 litro

4 niveaux - set de 5:

- 1 support poli mat
- 4 bols en plastique mat, approx. 1 litre

| | cm | ↑ cm |
|-------|---------|------|
| 11446 | 19 x 31 | 53 |



Ergänzung für alle Multi-Racks
suplemento para todos los dispensadores
compléments pour support multi-rack



Schütte / canister / cuenco / bol

| | cm | ↑ cm | ltr. |
|-------|-------------|------|------|
| 11455 | 19,5 x 16,5 | 10,5 | 1,0 |



BUFFET STANDS



Buffetständer „STAR“

buffet stand
soporte para buffet
présentoire buffet

Metall, mit schwarzer Antirutschbeschichtung

metal, with black anti-slide coating
metal, con revestimiento antideslizante negro
métal, avec revêtement antidérapant noir



| | ↑ cm |
|-------|------|
| 33260 | 8 |
| 33261 | 12 |
| 33262 | 18 |



Buffetständer „MULTI“

buffet stand
soporte para buffet
présentoir buffet

Metall, mit schwarzer Antirutschbeschichtung

metal, with black anti-slide coating
metal, con revestimiento antideslizante negro
métal, avec revêtement antidérapant noir



| | Ø cm | ↑ cm |
|-------|-----------|------|
| 33269 | 15,5 / 18 | 8 |
| 33270 | 15,5 / 18 | 10 |
| 33271 | 15,5 / 18 | 18 |

| | cm | ↑ cm |
|-------|---------|------|
| 33249 | 18 x 18 | 5 |
| 33250 | 18 x 18 | 8 |
| 33251 | 18 x 18 | 10 |
| 33252 | 18 x 18 | 18 |



Buffetständer „PRISMA“

buffet stand
soporte para buffet
présentoir buffet

Metall, mit schwarzer Antirutschbeschichtung

metal, with black anti-slide coating
metal, con revestimiento antideslizante negro
métal, avec revêtement antidérapant noir



| | Ø cm | ↑ cm |
|-------|------|------|
| 33272 | 20 | 10,5 |
| 33273 | 20 | 20,0 |



Buffetständer „KING“

buffet stand
soporte para buffet
présentoir buffet

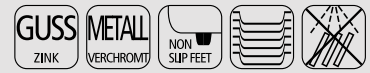

kein Verrutschen, Arme und Boden sind mit Antirutschflächen ausgestattet, schwere standsichere Qualität, Fuß dient als Löffelablage

the arms and base are equipped with non-slip surfaces, stable quality, base serves as spoon holder

revestimiento antideslizante en las puntas de los brazos y en la base, estable y alta calidad, la base sirve como reposacuchara

revêtement antidérapant sur les extrémités des 3 pieds et sur la base, robuste, stable et bonne qualité, la base sert de support pour les couverts

| | Ø cm | ↑ cm |
|-------|------|------|
| 03622 | 15 | 14 |
| 03623 | 15 | 21 |

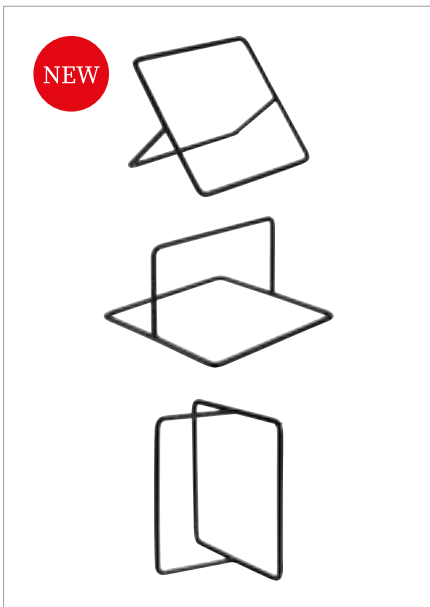

NEW

Buffetständer „SQUARE“

buffet stand
soporte para buffet
présentoir buffet



Metall, mit schwarzer Antirutschbeschichtung

metal, with black anti-slide coating

metal, con revestimiento antideslizante negro

métal, avec revêtement antidérapant noir

| | cm | ↑ cm |
|-------|---------|------|
| 33305 | 12 x 12 | 7 |



Präsentationsmöglichkeit | presentation example



NEW

Buffetständer „PERFECTO“

buffet stand
soporte para buffet
présentoir buffet



Metall, mit schwarzer Antirutschbeschichtung

metal, with black anti-slide coating

metal, con revestimiento antideslizante negro

métal, avec revêtement antidérapant noir

| | cm | ↑ cm | fits to |
|-------|---------|------|--------------|
| 33304 | 19 x 23 | 40,5 | 33202, 33303 |



NEW

Buffetständer „FRIDA“

buffet stand
soporte para buffet
présentoir buffet



Metall, mit schwarzer Antirutschbeschichtung

metal, with black anti-slide coating

metal, con revestimiento antideslizante negro

métal, avec revêtement antidérapant noir

| | Ø cm | ↑ cm | fits to |
|-------|-----------|------|--------------|
| 33282 | 23 / 30,5 | 17 | 85230, 85231 |

BUFFET STANDS

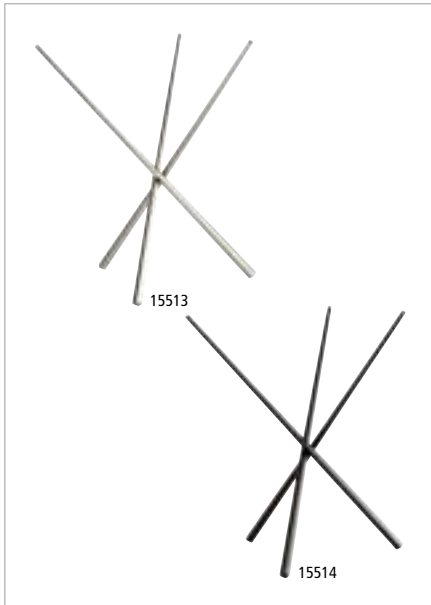

Buffetständer „ASIA PLUS“

buffet stand
soporte para buffet
présentoir buffet



| | Ø cm | ↑ cm | Farbe / Colour |
|-------|-------------|------|----------------|
| 15513 | 20,5 / 16,5 | 20 | Grey |
| 15514 | 20,5 / 16,5 | 20 | Black |



Präsentationsmöglichkeit
presentation example



Buffetständer

buffet stand
expositor de buffet
présentoir buffet



Akazienholz
acacia wood
madera de acacia
bois d'acacia

| | Ø cm | ↑ cm |
|-------|------|------|
| 33255 | 15 | 10 |
| 33256 | 25 | 15 |



Präsentationsmöglichkeit
presentation example



Buffetständer „WOOD“

buffet stand
soporte para buffet
présentoire buffet



Akazienholz, liegend oder stehend, variable Nutzungsmöglichkeiten
acacia wood, usable by lying or standing, variable usage possibilities
madera de acacia, se puede usar tumbado o de pie, opciones de uso variable
bois d'acacia, possibilités d'utilisation variables

| | cm | ↑ cm | Farbe / Colour |
|-------|---------|------|----------------|
| 33280 | 20 x 20 | 17,5 | Yellow |
| 33281 | 20 x 20 | 17,5 | Black |



liegend oder stehend, variable Nutzungsmöglichkeiten
vertically or horizontally, variable usage possibilities

HOCHSTAPLER



Distanzstücke erhöhen die Nutzhöhe auf 4 cm

GN 1/1 System-Tablett „PROFI LINE“

GN 1/1 tray
GN 1/1 bandeja
GN 1/1 plateau



Dekorrand, hochglanzpoliert, Griffe verchromt, Distanzstücke erhöhen die Nutzhöhe auf 4 cm
decor edge, mirror polished, chrome plated handles, spacers increase the useful height to 4 cm
borde decorado pulido brillante, asas cromadas, los separadores aumentan la altura útil a 4 cm
bord avec reliefs poli brillant, poignées chromées, les entretoises portent la hauteur utile à 4 cm

| | cm | ↑ cm | GN |
|-------|-----------|------|-----|
| 11300 | 53 x 32,5 | 5,5 | 1/1 |

11150
mit verchromten Griffen

11155
mit vergoldeten Griffen

GN 1/1 System-Tablett „BUFFET-STAR“

GN 1/1 tray
GN 1/1 bandeja
GN 1/1 plateau



Rand hochglanzpoliert, Distanzstücke erhöhen die Nutzhöhe auf 4 cm
mirror polished edge, spacers increase the useful height to 4 cm
borde pulido brillante, los separadores aumentan la altura útil a 4 cm
bord poli brillant, les entretoises portent la hauteur utile à 4 cm

| | cm | ↑ cm | GN | Griff / handle |
|-------|-----------|------|-----|----------------|
| 11150 | 53 x 32,5 | 6,5 | 1/1 | gold |
| 11155 | 53 x 32,5 | 6,5 | 1/1 | silver |

für platzsparende Servieren, Lagern und Transportieren
for space-saving serving, storing and transporting

GN 1/1 System-Tablett „CLASSIC“

GN tray
GN bandeja
GN plat empilable système catering



Rand hochglanzpoliert, Distanzstücke erhöhen die Nutzhöhe auf 4 cm
mirror polished edge, spacers increase the useful height to 4 cm
borde pulido brillante, los separadores aumentan la altura útil a 4 cm
bord poli brillant, les entretoises portent la hauteur utile à 4 cm

| | cm | ↑ cm | GN |
|-------|-----------|------|-----|
| 11295 | 53 x 32,5 | 5,0 | 1/1 |

11305
Haube / cover

11300
Tablett / tray

GN 1/1 Haube „HOCHSTAPLER“

GN 1/1 cover
GN 1/1 campana
GN 1/1 cloche



glasklarer Kunststoff, Haube fixiert sich auf dem Tablett, nahezu bruchfest
clear plastic, cover fixes itself on the tray, nearly unbreakable
plástico transparente, la tapa se fija a la bandeja para que no se deslice, resistente a la rotura
en plastique transparent, la cloche se fixe sur le dessous du plateau, résistant à la casse

| | cm | ↑ cm | fits to | GN |
|-------|-----------|------|--------------|-----|
| 11305 | 53 x 32,5 | 9 | 11300, 11295 | 1/1 |



GN Behälter „PROFI LINE“

GN pan
GN cubeta
GN bac



| | cm | ↑ cm | GN | ltr. |
|-------|-------------|------|-----|------|
| 11020 | 53,0 x 32,5 | 2,0 | 1/1 | 1,7 |
| 11040 | 53,0 x 32,5 | 4,0 | 1/1 | 3,4 |
| 11065 | 53,0 x 32,5 | 6,5 | 1/1 | 7,0 |
| 12065 | 32,5 x 26,5 | 6,5 | 1/2 | 3,3 |



GN Tablett „PROFI LINE“

GN tray
GN bandeja
GN plateau



mit glattem Rand / with smooth edge / borde liso / bord lisse

| | cm | ↑ cm | GN |
|-------|-------------|------|-----|
| 11100 | 53,0 x 32,5 | 1,5 | 1/1 |
| 12100 | 32,5 x 26,5 | 1,5 | 1/2 |

mit Dekor-Rand / with decor-edge / con borde decorado / bords avec relief

| | cm | ↑ cm | GN |
|-------|-------------|------|-----|
| 11000 | 53,0 x 32,5 | 1,5 | 1/1 |
| 12000 | 32,5 x 26,5 | 1,5 | 1/2 |

glatter schmaler Rand / smooth narrow edge / borde estrecho liso / bord étroit lisse

| | cm | ↑ cm | GN |
|-------|-------------|------|-----|
| 11110 | 53,0 x 32,5 | 1,0 | 1/1 |



Tablett „PROFI LINE“

tray
bandeja
plateau



Dekorrand hochglanzpoliert
decor edge mirror polished
borde decorado pulido brillante
contour relief poli brillant

| | Ø cm | ↑ cm |
|-------|------|------|
| 11032 | 32 | 2,5 |
| 11038 | 38 | 2,5 |
| 11048 | 48 | 2,5 |



GN Abdeckhaube

GN cover
GN campana
GN cloche



| | cm | ↑ cm | ✱ mm | GN |
|-------|-------------|------|------|-----|
| 11041 | 32,5 x 26,5 | 9,5 | 3 | 1/2 |
| 11042 | 53,0 x 32,5 | 9,5 | 3 | 1/1 |
| 11043 | 32,5 x 17,6 | 10,5 | 3 | 1/3 |
| 11044 | 53,0 x 16,2 | 10,5 | 3 | 2/4 |



Tablett „SCHÖNER ESSEN“

tray
bandeja
plateau



mit Dekorrand, Griffe Zinkdruckguss verchromt, genietet

with decor edge, handles zinc alloy chrome plated, riveted

borde decorado, asas de fundición inyectada de cinc cromado, remachadas

bord décor, poignées en zamac chromé, rivetées

| | cm | ↑ cm |
|-------|-----------|------|
| 00082 | 52 x 31,0 | 3,0 |
| 00081 | 60 x 36,0 | 3,0 |
| 00084 | 75 x 44,5 | 3,0 |



Tablett „SCHÖNER ESSEN“

tray
bandeja
plateau



| | cm | ↑ cm | GN |
|-------|-------------|------|-----|
| 00383 | 35,0 x 24,0 | 1,0 | |
| 00382 | 42,0 x 31,0 | 1,0 | |
| 00381 | 50,0 x 36,0 | 1,0 | |
| 00384 | 63,5 x 44,5 | 1,0 | |
| 00385 | 60,0 x 40,0 | 1,0 | |
| 00388 | 53,0 x 32,5 | 1,0 | 1/1 |

leichte Ausführung 0,5 mm / light model / modelo ligero / qualité légère

| | cm | ↑ cm |
|-------|-------------|------|
| 03824 | 42,0 x 31,0 | 1,0 |



Tablett „SCHÖNER ESSEN“

tray
bandeja
plateau



| | cm | ↑ cm |
|-------|---------|------|
| 00087 | 38 x 23 | 1,5 |



Tablett „SCHÖNER ESSEN“

tray
bandeja
plateau



| | Ø cm | ↑ cm |
|-------|------|------|
| 00075 | 31 | 1,0 |
| 00085 | 35 | 1,0 |



Tablett mit Haube „SCHÖNER ESSEN“

tray with cover
bandeja con campana
plateau avec cloche



| | cm | ↑ cm |
|-------|---------|------|
| 38202 | 42 x 31 | 8 |

Haube / cover / campana / cloche

| | cm | ↑ cm |
|-------|-------------|------|
| 08201 | 36,5 x 26,0 | 7,5 |



Schale

bowl
cuenco
bol

ingerollter Rand

rolled edge
borde enrollado
bord roulé



| | cm | ↑ cm | ltr. |
|-------|-------------|------|------|
| 40110 | 26,5 x 18,5 | 4,0 | 0,8 |
| 40115 | 31,0 x 21,0 | 4,5 | 1,3 |



Servierpfanne

pan
fuente para la mesa
plat pour la table

mit vergoldeten Edelstahlgriffen, 1 mm dick

with gold-plated stainless steel handles, 1 mm thick
con asas doradas de acero inoxidable de 1 mm de grosor
avec poignées dorées en acier inox, 1 mm d'épaisseur



| | cm | ↑ cm | ltr. |
|-------|-------------|------|------|
| 61190 | 19 | 3,5 | 0,7 |
| 61280 | 28 | 4,0 | 2,0 |
| 61400 | 40 | 5,0 | 4,5 |
| 60270 | 26,5 x 19,5 | 3 | 0,8 |
| 60310 | 31,0 x 21,5 | 3 | 1,2 |



Edelstahltablett „FOCUS“

tray
bandeja
plateau



| | cm | ↑ cm |
|-------|-------------|------|
| 09010 | 43,5 x 32,5 | 1,5 |

Rolltophaube „FOCUS“ / rolltop cover / campana abatible / cloche basculante

| | cm | ↑ cm |
|-------|-----------|------|
| 09013 | 44 x 33,5 | 17 |



Tablett „ELEGANCE“

tray
bandeja
plateau



| | cm | ↑ cm |
|-------|---------|------|
| 02310 | 41 x 26 | 1,0 |
| 02311 | 48 x 30 | 1,0 |
| 02312 | 60 x 37 | 1,0 |



Tablett „FINESSE“

tray
bandeja
plateau



verchromte Messinggriffe / chrome plated brass handles / asas plateadas de latón / poignées en laiton chromées

| | Ø cm | ↑ cm |
|-------|------|------|
| 01738 | 38 | 1,5 |
| 01748 | 48 | 1,5 |



Tablett „FINESSE“

tray
bandeja
plateau



verchromte Messinggriffe / chrome plated brass handles / asas plateadas de latón / poignées en laiton chromées

| | cm | ↑ cm |
|-------|---------|------|
| 01712 | 44 x 31 | 1,5 |
| 01711 | 52 x 38 | 1,5 |
| 01710 | 60 x 42 | 1,5 |
| 01709 | 70 x 48 | 1,5 |



Tablett „FINESSE“

tray
bandeja
plateau



| | cm | ↑ cm |
|-------|---------|------|
| 01322 | 42 x 30 | 2,5 |
| 01323 | 50 x 36 | 2,5 |
| 01324 | 60 x 41 | 2,5 |
| 01325 | 70 x 46 | 2,5 |



Tablett „FINESSE“

tray
bandeja
plateau



| | Ø cm | ↑ cm |
|-------|------|------|
| 01332 | 32,0 | 1,0 |
| 01335 | 35,0 | 1,0 |
| 01338 | 38,0 | 1,0 |
| 01348 | 48,0 | 1,0 |
| 01349 | 48,5 | 1,0 |



Tablett „FINESSE“

tray
bandeja
plateau



| | cm | ↑ cm |
|-------|---------|------|
| 01314 | 30 x 24 | 1,0 |
| 01313 | 35 x 24 | 1,0 |
| 01317 | 39 x 26 | 1,0 |
| 01312 | 42 x 31 | 1,0 |
| 01318 | 48 x 30 | 1,0 |
| 01311 | 50 x 38 | 1,0 |
| 01310 | 58 x 42 | 1,0 |
| 01309 | 68 x 48 | 1,0 |



2 tlg.
2 pcs.

Tablett mit Haube „FINESSE“

tray with cover
bandeja con campana
plateau avec cloche

2-teilig: Tablett aus Edelstahl + Haube

2 pcs.: stainless steel tray + cover
set de 2: bandeja de acero inoxidable + campana
set de 2: plateau en acier inox + cloche



| | | |
|-------|---------|------|
| | cm | ↑ cm |
| 13122 | 42 x 31 | 8,5 |



2 tlg.
2 pcs.

Tablett mit Haube „FINESSE“

tray with cover
bandeja con campana
plateau avec cloche

2-teilig: Tablett aus Edelstahl + Haube

2 pcs.: stainless steel tray + cover
set de 2: bandeja de acero inoxidable + campana
set de 2: plateau en acier inox + cloche



| | | |
|-------|------|------|
| | Ø cm | ↑ cm |
| 13622 | 22 | 9,5 |



2 tlg.
2 pcs.

Tablett mit Haube „FINESSE“

tray with cover
bandeja con campana
plateau avec cloche

2-teilig: Tablett aus Edelstahl + Haube

2 pcs.: stainless steel tray + cover
set de 2: bandeja de acero inoxidable + campana
set de 2: plateau en acier inox + cloche



| | | | |
|-------|------|------|---------------------|
| | Ø cm | ↑ cm | Ø cm Hauben / cover |
| 13382 | 38 | 12 | 30 |
| 13385 | 38 | 13 | 33 |



2 tlg.
2 pcs.

Tablett mit Haube

tray with cover
bandeja con campana
plateau avec cloche

2-teilig: Tablett aus Edelstahl, hochglanzpoliert + Haube

2 pcs.: stainless steel tray, mirror polished + cover
set de 2: bandeja de acero inoxidable, pulido brillante + campana
set de 2: plateau en acier inox, poli brillant + cloche



| | | |
|-------|------|------|
| | Ø cm | ↑ cm |
| 00827 | 27 | 12,5 |



2 tlg.
2 pcs.

Tablett mit Haube

tray with cover
bandeja con campana
plateau avec cloche

2-teilig: Tablett aus Edelstahl, hochglanzpoliert + Haube

2 pcs.: stainless steel tray, mirror polished + cover
set de 2: bandeja de acero inoxidable, pulido brillante+ campana
set de 2: plateau en acier inox, poli brillant + cloche



| | | |
|-------|-----------|------|
| | cm | ↑ cm |
| 00828 | 30 x 15,5 | 10,5 |



Tablett mit Haube „ELEGANCE“

tray with cover
bandeja con campana
plateau avec cloche

2-teilig: Tablett aus Edelstahl + Haube

2 pcs.: stainless steel tray + cover
set de 2: bandeja de acero inoxidable + campana
set de 2: plateau en acier inox + cloche



| | cm | ↑ cm |
|-------|---------|------|
| 23642 | 35 x 19 | 10 |



Tablett mit Haube „ELEGANCE“

tray with cover
bandeja con campana
plateau avec cloche

2-teilig: Tablett aus Edelstahl + Haube

2 pcs.: stainless steel tray + cover
set de 2: bandeja de acero inoxidable + campana
set de 2: plateau en acier inox + cloche



| | cm | ↑ cm |
|-------|---------|------|
| 00064 | 33 x 17 | 10 |
| 00067 | 25 x 19 | 7 |

Haube für 00064 / cover for 00064 / campana para 00064 / cloche pour 00064

06401

Haube für 00067 / cover for 00067 / campana para 00067 / cloche pour 00067

06701



Tortenplatte

cake plate
bandeja tartas
plat à gâteau

2-teilig: Tablett aus Edelstahl + Haube

2 pcs.: stainless steel tray + cover
set de 2: bandeja de acero inoxidable + campana
set de 2: plateau en acier inox + cloche



| | Ø cm | ↑ cm | |
|-------|------|--------|-----------------------------|
| 00065 | 30 | 11 | mit 1 Haube / with 1 cover |
| 00652 | 30 | 7 + 11 | mit 2 Hauben / with 2 cover |



Tortenplatte „BAROCK“

cake plate
bandeja tartas
plat à gâteau

2-teilig: Tortenplatte mit Barock-Rand + Haube

2 pcs.: cake plate with decor edge „Barock“ + cover
set de 2: porta tartas, borde decor „Barock“ + campana
set de 2: plateau bord décor „Barock“ + cloche



| | Ø cm | ↑ cm |
|-------|------|------|
| 06503 | 32 | 10 |

Frischhaltehaube / cover / campana / cloche

| | Ø cm | ↑ cm |
|-------|------|------|
| 06510 | 30 | 11,5 |



Rolltop-Set

rolltop set
set rolltop
set cloche à fromage



2-teilig: Tablett + Rolltophaube glasklar, rutschfeste Haubenfixierung, klappbar

2 pcs.: tray + rolltop cover, cover non-slip fixed, mountable

set de 2: bandeja + campana abatible fijación antideslizante, montable

set de 2: plateau + cloche abattante, fixation antidérapants, montable

| | Ø cm | ↑ cm |
|-------|------|------|
| 09080 | 38 | 24 |
| 09099 | 50 | 28 |



Rolltop-Set, 3-teilig

rolltop set, 3 pcs.
rolltop, set de 3
rolltop, set de 3



1 Edelstahltablett Ø 38 cm + 1 Naturschieferplatte Ø 33 cm + 1 Rolltophaube Ø 38 cm

1 stainless tray Ø 38 cm + 1 natural slate tray Ø 33 cm + 1 rolltop cover Ø 38 cm

1 bandeja de acero inoxidable Ø 38 cm + 1 bandeja de pizarra natural Ø 33 cm + 1 tapa abatible Ø 38 cm

1 plat inox Ø 38 cm + 1 plat ardoise naturelle Ø 33 cm + 1 cloche Ø 38 cm

| | Ø cm | ↑ cm |
|-------|------|------|
| 01000 | 38 | 24 |



Kaviarkühler

caviar cooler
enfriador de caviar
rafraîchisseur de caviar



4-teilig: 1 Edelstahlschale, 1 Halter, 1 Glasschale, 1 Edelstahldeckel

4 pcs.: 1 stainless steel bowl, 1 holder, 1 glass bowl Ø 10 cm, 1 stainless steel cover

set de 4: 1 bol de acero inoxidable, 1 soporte, 1 bol de vidrio Ø 10 cm, 1 tapa de acero inoxidable

set de 4: 1 bol en acier inox, 1 support, 1 bol en verre Ø 10 cm, 1 couvercle en acier inox

| | Ø cm | ↑ cm |
|-------|------|------|
| 01699 | 18 | 12 |



Serviertöpfchen „MUMBAI“

small serving pot
olla pequeña de servir
marmite petite de servir



gehämmerte Oberfläche

hammered surface

superficie martillada

surface martelée

| | Ø cm | ↑ cm | ltr. | Griff / handle cm |
|-------|------|------|------|-------------------|
| 40186 | 9,5 | 5,5 | 0,30 | 2,5 |
| 40187 | 13,5 | 5,0 | 0,55 | 3,0 |
| 40188 | 15,5 | 5,0 | 0,75 | 3,0 |



Tablett mit Haube

tray with cover
bandeja con campana
plateau avec cloche

2 teilig: Tablett aus geöltem Buchenholz (Ø 18,5 cm, H: 2,5 cm) + Glas-Haube (Ø 16 cm, H: 22,5 cm)

2 pcs.: tray of oiled beech wood + glass cover
set de 2: bandeja de madera haya + campana de cristal
set de 2 : plateau en bois de hêtre + cloche en verre



| | Ø cm | ↑ cm |
|-------|------|------|
| 00830 | 18,5 | 24 |



Tablett mit Haube, 2-teilig

tray with cover, 2 pcs.
bandeja con campana, set de 2
plateau avec cloche, set de 2

Tablett aus Bambus, ölprägniert + Haube

bamboo tray, oil-impregnated + cover
bandeja de bambú, impregnada de aceite + campana
plateau en bambou, imprégné d'huile + cloche



| | Ø cm | ↑ cm |
|-------|------|------|
| 00825 | 25 | 13,5 |



Tablett mit Haube, 2-teilig

tray with cover, 2 pcs.
bandeja con campana, set de 2
plateau avec cloche, set de 2

Tablett aus Bambus, ölprägniert + Haube

bamboo tray, oil-impregnated + cover
bandeja de bambú, impregnada de aceite + campana
plateau en bambou, imprégné d'huile + cloche



| | cm | ↑ cm |
|-------|---------|------|
| 00826 | 28 x 14 | 11,5 |



Tablett mit Haube, 2 teilig

tray with cover, 2 pcs.
bandeja con campana, set de 2
plateau avec cloche, set de 2

Tablett aus Bambus, ölprägniert + Haube

bamboo tray, oil-impregnated + cover
bandeja de bambú, impregnada de aceite + campana
plateau en bambou, imprégné d'huile + cloche



| | Ø cm | ↑ cm |
|-------|------|------|
| 00822 | 20,5 | 10 |

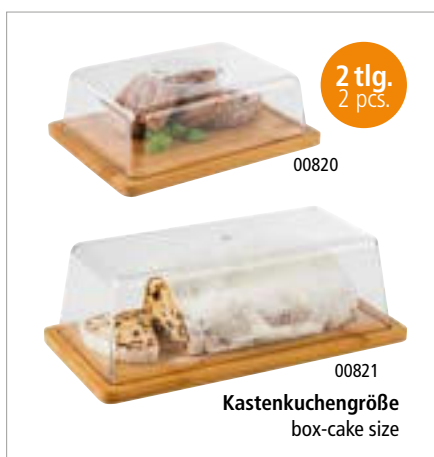

Tablett mit Haube, 2 teilig

tray with cover, 2 pcs.
bandeja con campana, set de 2
plateau avec cloche, set de 2

Tablett aus Bambus, ölprägniert + Haube

bamboo tray, oil-impregnated + cover
bandeja de bambú, impregnada de aceite + campana
plateau en bambou, imprégné d'huile + cloche



| | cm | ↑ cm |
|-------|-----------|------|
| 00820 | 24 x 18,5 | 8 |
| 00821 | 32 x 16,5 | 11 |



Warenträger
display | expositor | présentoir

für Partyplatten

- platzsparende flexible Präsentation durch geringe Abmessungen
- als Zweitplatzierung für Ihre zusätzlichen Umsätze
- in weiß lieferbar

- para bandejas party
- presentación flexible que ahorra espacio gracias a sus pequeñas dimensiones
 - como colocación secundaria para sus ventas adicionales
 - disponible en blanco

for party trays

- space-saving flexible presentation due to small dimensions
- as secondary placement for your additional sales
- available in white

- pour les plateaux party
- présentation flexible peu encombrante grâce à ses dimensions réduites
 - comme deuxième emplacement pour vos ventes supplémentaires
 - disponible en blanc

| | cm | ↑ cm |
|-------|---------|------|
| 00397 | 55 x 65 | 190 |



Partyplatte „CLASSIC“

partytray
bandeja party
plateau party

Rand eingerollt
rolled edge
borde enrollado
bord enroulé



| | cm | ↑ cm | GN | | VE / unit |
|-------|-------------|------|-----|-------|-----------|
| 00396 | Ø 35 | 1,5 | - | round | 48 |
| 00398 | 46,0 x 34,0 | 1,5 | - | oval | 48 |
| 00399 | 41,0 x 31,0 | 1,5 | - | | 48 |
| 00389 | 35,4 x 32,5 | 1,5 | 2/3 | | 48 |
| 00395 | 53,0 x 32,5 | 1,5 | 1/1 | | 36 |



Partyplatte „CLASSIC“

partytray
bandeja party
plateau party

Rand eingerollt
rolled edge
borde enrollado
bord enroulé



| | cm | ↑ cm | | VE / unit |
|-------|---------|------|-------|-----------|
| 00393 | Ø 35 | 1,5 | round | 48 |
| 00391 | 46 x 34 | 1,5 | oval | 48 |

| | cm | ↑ cm | GN | VE / unit |
|-------|-----------|------|-----|-----------|
| 00392 | 41 x 31 | 1,5 | - | 48 |
| 00394 | 53 x 32,5 | 1,5 | 1/1 | 48 |





Serviertablett „KAFFEEHAUS“

tray
bandeja
plateau

hochglanzpoliert, stabiler Rand eingerollt
mirror polished, stable edge rolled in
pulido brillante, borde estable enrollado
poli brillant, bord stable enroulé



| | cm | ↑ cm | |
|-------|-----------|------|--|
| 30148 | Ø 27 | 1,5 | |
| 30149 | 30 x 15,5 | 1,5 | |

passende Hauben / cover / campana / cloche



| | cm | ↑ cm | suitable for |
|-------|---------|------|--------------|
| 11055 | Ø 23 | 12,0 | 30148 |
| 11056 | 26 x 12 | 10,0 | 30149 |



Servierbeispiel
presentation example



Serviertablett „KAFFEEHAUS“

tray
bandeja
plateau

matt poliert, oval, Rand eingerollt
matt polished, oval, rolled edge
pulido mate, oval, borde enrollado
poli mat, ovale, bord enroulé



| | cm | ↑ cm | |
|-------|-------------|------|--|
| 30111 | 20,0 x 14,5 | 0,5 | für Zucker und Sahne / for sugar and cream |
| 30112 | 26,5 x 19,5 | 0,5 | für eine Tasse / for one cup |
| 30113 | 29,0 x 22,0 | 0,5 | für zwei Tassen / for two cups |

Antik-Edelstahl-Look

stainless steel antique look
acero estilo antiguo
acier style antique



| | cm | ↑ cm | |
|-------|-------------|------|--|
| 30140 | 20,0 x 14,5 | 1,0 | für Zucker und Sahne / for sugar and cream |
| 30141 | 26,5 x 19,5 | 1,0 | für eine Tasse / for one cup |
| 30142 | 29,0 x 22,0 | 1,0 | für zwei Tassen / for two cups |



Serviertablett „KAFFEEHAUS“

tray
bandeja
plateau

hochglanzpoliert, oval, Rand eingerollt
mirror polished, oval, rolled edge
pulido brillante, ovalado, borde enrollado
poli brillant, ovale, bord enroulé



| | cm | ↑ cm | |
|-------|-------------|------|---|
| 30115 | 20,0 x 14,5 | 0,5 | für Zucker und Sahne / for sugar and cream para azúcar y crema / pour le sucre et la crème |
| 30116 | 26,5 x 19,5 | 0,5 | für eine Tasse / for one cup para una taza / pour une tasse |
| 30117 | 29,0 x 22,0 | 0,5 | für zwei Tassen / for two cups para dos tazas / pour deux tasses |



Serviertablett „KAFFEEHAUS“

tray
bandeja
plateau

matt poliert, Rand eingerollt
matt polished, rolled edge
pulido mate, borde enrollado
poli mat, bord enroulé



| | cm | ↑ cm |
|-------|-----------|------|
| 30118 | 21,5 x 13 | 1,5 |
| 30119 | 23,0 x 23 | 1,5 |
| 30120 | 20,0 x 11 | 1,5 |
| 30121 | 29,0 x 20 | 1,5 |



Serviertablett „KAFFEEHAUS“

tray
bandeja
plateau

matt poliert, oval
matt polished, oval
pulido mate, oval
poli mat, ovale



| | cm | ↑ cm |
|-------|-------------|------|
| 30126 | 25,5 x 19,5 | 2 |



Serviertablett „KAFFEEHAUS“

tray
bandeja
plateau



| | cm | ↑ cm | Farbe / Colour |
|-------|-------------|------|----------------|
| 84251 | 26,0 x 20,0 | 1,5 | ■ |
| 84253 | 28,5 x 21,5 | 1,5 | ■ |



Serviertablett „KAFFEEHAUS“

tray
bandeja
plateau

Innenfläche ziseliert, Rand eingerollt
chiselled inner surface, rolled edge
superficie interior cincelada, borde enrollado
surface intérieure ciselée, bord enroulé



| | cm | ↑ cm | VE / unit |
|-------|---------|------|-----------|
| 30114 | 30 x 22 | 1,0 | 48 |



Tablett „VINTAGE“

tray
bandeja
plateau

Antik-Edelstahl-Look
stainless steel antique look
acero estilo antiguo
acier style antique



| | cm | ↑ cm |
|-------|-------------|------|
| 30130 | 26,0 x 13,5 | 1,5 |
| 30131 | 34,0 x 18,0 | 1,5 |
| 30132 | 38,0 x 26,5 | 1,5 |
| 30133 | 25,5 x 16,0 | 3,0 |
| 30134 | 32,5 x 21,5 | 2,0 |

passende Schälchen / fitting bowls / cuencos adecuados / bols appropriés



| | Ø cm | ↑ cm | ltr. |
|-------|------|------|------|
| 40655 | 7,5 | 5,5 | 0,17 |
| 40656 | 7,5 | 10,0 | 0,35 |

Wachspapier / greaseproof paper squares / papel alimenticio / papier alimentaire

| | cm | pcs. | Motiv: Zeitung |
|-------|---------|------|----------------|
| 40670 | 42 x 25 | 500 | |



Servierbeispiel
presentation example



Tablett „TREND“

baking sheet
bandeja
plateau

ein Backblech wird zum Serviertablett
a baking sheet which becomes a serving tray
una bandeja de hornear que se convierte en una bandeja de servir
un moule qui devient un plateau de service



| | cm | ↑ cm |
|-------|-----------|------|
| 13380 | 32 x 21,5 | 2 |

NATURAL SLATE



EXTRA STRONG
6-9 mm thickness

Naturschiefer speichert auf natürliche Weise Kälte besonders gut. Die Kanten der Platten sind gebrochen und nicht gesägt.

Natural slate stores cold particularly well in a natural way. The edges of the panels are broken and not sawn.

La pizarra natural almacena el frío especialmente bien de forma natural. Los bordes de las bandejas están rotos y no aserrados.

L'ardoise naturelle stocke particulièrement bien le froid de manière naturelle. Les bords des plateaux sont brisés et non sciés.

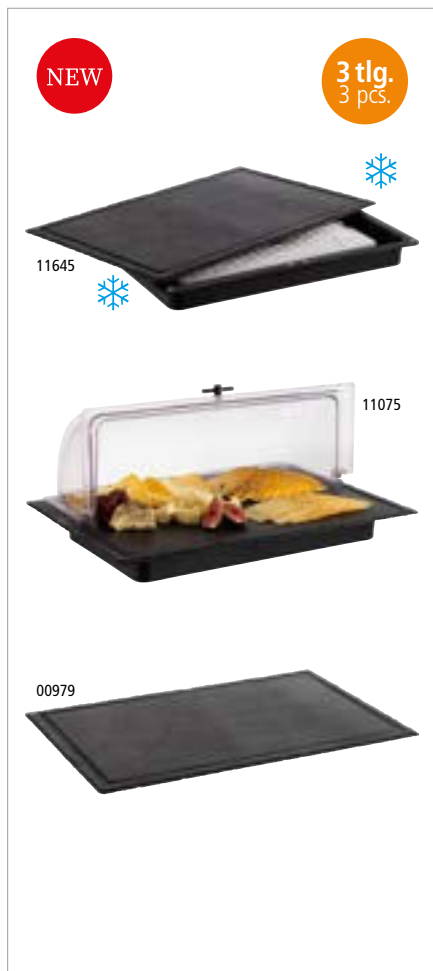

Kühlbox „SLATE“ refrigerated buffet display expositor buffet frío plateau buffet froid

3-teilig, bestehend aus: 1 Basis aus schwarzem Polystyrol,
1 Naturschieferplatte, 1 Kühlakku (ohne Haube)
3 pcs., set consists of: 1 base made of black polystyrene, 1 natural slate tray, 1 cooler (without cover)

set de 3 compuesto por: 1 soporte de poliestireno negro, 1 bandeja de pizarra natural, 1 acumulador de frío (sin campana)

set de 3 composé de: 1 support en polystyrène noir, 1 plateau en ardoise naturelle, 1 accumulateur de froid (sans couvercle)



| | cm | ↑ cm |
|-------|---------|------|
| 11645 | 58 x 38 | 6,5 |

Naturschieferplatte / natural slate tray / bandeja de pizarra natural / plateau ardoise naturelle

| | cm | * mm |
|--------------------------|---------|-------|
| 00979 <small>NEW</small> | 58 x 38 | 6 - 9 |

Kühlakku / cooler / acumulador de frío / accumulateur de froid

| | cm | ↑ cm |
|-------|---------|------|
| 10782 | 41 x 21 | 2,5 |

Basis / base / soporte / support

| | cm | ↑ cm |
|--------------------------|---------|------|
| 11619 <small>NEW</small> | 52 x 32 | 5,5 |

GN Rolltophaube mit schwarzem Griff / GN rolltop cover with black handle / GN campana rolltop con mango negro / GN cloche rolltop avec poignée noire

| | cm | ↑ cm | GN |
|--------------------------|-----------|------|-----|
| 11075 <small>NEW</small> | 53 x 32,5 | 19 | 1/1 |



GN 1/1 Naturschieferplatte „HOCHSTAPLER“ GN 1/1 natural slate tray GN 1/1 bandeja de pizarra natural GN 1/1 plat ardoise naturelle



| | cm | ↑ cm | * mm |
|-------|-----------|------|-------|
| 00966 | 53 x 32,5 | 6 | 6 - 9 |



Griffe verchromt, 4 cm Nutzhöhe
chrome plate handles, 4 cm distance

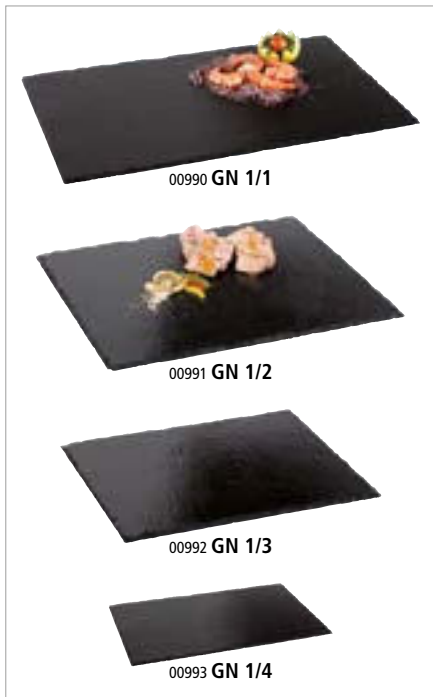

GN Naturschieferplatten
 GN natural slate tray
 GN bandeja de pizarra natural
 GN plat ardoise naturelle



| | cm | ✱ mm | GN |
|-------|-------------|-------|-----|
| 00990 | 53,0 x 32,5 | 6 - 9 | 1/1 |
| 00991 | 32,5 x 26,5 | 6 - 9 | 1/2 |
| 00992 | 32,5 x 17,6 | 6 - 9 | 1/3 |
| 00993 | 26,5 x 16,2 | 6 - 9 | 1/4 |
| 00973 | 53,0 x 16,2 | 6 - 9 | 2/4 |



Naturschieferplatte
 natural slate tray
 bandeja de pizarra natural
 plat ardoise naturelle



| | cm | ✱ mm | |
|-------|---------|-------|----------------------------------|
| 00996 | 45 x 30 | 6 - 9 | |
| 00979 | 58 x 38 | 6 - 9 | mit Safrille / with juice groove |



Naturschieferplatte
 natural slate tray
 bandeja de pizarra natural
 plat ardoise naturelle



| | cm | ✱ mm |
|-------|---------|-------|
| 00994 | 25 x 25 | 6 - 9 |
| 00995 | 30 x 30 | 6 - 9 |



Naturschieferplatte
 natural slate
 bandeja de pizarra natural
 plateau ardoise naturelle



| | cm | ✱ mm |
|-------|-------------|-------|
| 00941 | 24,0 x 15,0 | 6 - 9 |
| 00942 | 26,5 x 20,5 | 6 - 9 |
| 00943 | 47,0 x 10,0 | 6 - 9 |
| 00988 | 30,0 x 12,0 | 6 - 9 |

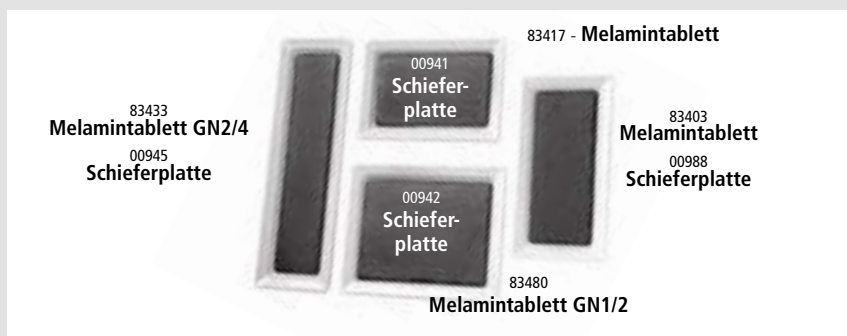



Naturschieferplatte
 natural slate tray
 bandeja pizarra natural
 plat ardoise naturelle

mit Safrille, Ø 9,5 cm Aussparung
 with juice groove, with hole Ø 9,5 cm
 con ranura para líquidos, con agujero Ø 9,5 cm
 avec rigole, avec trou Ø 9,5 cm



| | cm | ✱ mm |
|-------|---------|-------|
| 00947 | 33 x 24 | 6 - 9 |

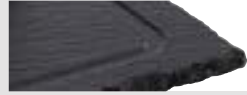

mit Safrille
 with juice groove

Wachspapier / greaseproof paper squares / papel alimenticio / papier alimentaire

| | cm | pcs. | Motiv: Zeitung |
|-------|---------|------|----------------|
| 40670 | 42 x 25 | 500 | |

Servier-Frittierkorb / fry baskets / cestitas para el servicio mesa / paniers pour le service sur table

| | Ø cm | ↑ cm | Griff / handle cm | Farbe / Colour |
|------------------|------|------|-------------------|-----------------|
| 40601 | 9 | 8,5 | 9,0 | stainless steel |
| 40603 | 9 | 8,5 | 9,0 | gold |
| 40625 NEW | 9 | 8,5 | 9,0 | black mat |



Naturschieferplatte
 natural slate tray
 bandeja pizarra natural
 plat ardoise naturelle

mit 3 x Ø 6 cm Aussparung
 with 3 holes, Ø 6 cm
 con 3 agujeros, Ø 6 cm
 avec 3 trous, Ø 6 cm



| | cm | ✱ mm |
|-------|---------|-------|
| 00987 | 28 x 10 | 6 - 9 |



Naturschieferplatte
 natural slate tray
 bandeja pizarra natural
 plat ardoise naturelle

mit Ø 6 cm Aussparung
 with hole Ø 6 cm
 con agujero Ø 6 cm
 avec trou Ø 6,0 cm



| | cm | ✱ mm |
|-------|---------|-------|
| 00986 | 25 x 12 | 6 - 9 |



Naturschieferplatte / Untersetzer
 natural slate tray
 bandeja de pizarra natural
 plateau ardoise naturelle

mit 2 x Ø 6 cm Aussparung
 with 2 holes Ø 6 cm
 con 2 agujeros Ø 6 cm
 avec 2 trous Ø 6 cm



| | cm | ✱ mm |
|-------|--------|-------|
| 00971 | 15 x 8 | 6 - 9 |

**Naturschieferplatte „STARTER“**

natural slate tray
bandeja de pizarra natural
plat ardoise naturelle



| | cm | * mm |
|-------|---------|-------|
| 00937 | 20 x 10 | 6 - 9 |



00969

Naturschieferplatte

natural slate tray
bandeja de pizarra natural
plat ardoise naturelle



| | Ø cm | * mm |
|-------|------|-------|
| 00968 | 22 | 6 - 9 |
| 00969 | 28 | 6 - 9 |
| 00998 | 33 | 6 - 9 |
| 00999 | 38 | 6 - 9 |



Präsentationsmöglichkeit
presentation example

**Tortenplatte / Servierplatte**

cake stand
soporte para pastel
présentoir à gâteaux

drehbar
rotatable
giratorio
rotatif



| | Ø cm | ↑ cm | * mm |
|-------|------|------|-------|
| 00975 | 32 | 2,5 | 6 - 9 |



drehbare Servierplatte
rotatable cake stand



3 tlg.
3 pcs.

Rolltop-Set

rolltop set
rolltop set
rolltop set

3-teilig: • 1 Edelstahltablett Ø 38 cm
• 1 Naturschieferplatte Ø 33 cm
• 1 Rolltophaube Ø 38 cm

3 pcs.: • 1 stainless steel tray Ø 38 cm
• 1 natural slate tray Ø 33 cm
• 1 rolltop cover Ø 38 cm

set de 3: • 1 bandeja de acero inoxidable Ø 38 cm
• 1 bandeja de pizarra natural Ø 33 cm
• 1 campana abatible Ø 38 cm

set de 3: • 1 plateau en acier inox 38 cm
• 1 plateau ardoise naturelle 33 cm
• 1 cloche basculante 38 cm



| | Ø cm | ↑ cm |
|-------|------|------|
| 01000 | 38 | 24 |



3-stufige Etagère

3-tier tray
bandeja con tres alturas
étagère carré 3 hauteurs

Naturschiefer, Akazienholz

natural slate tray, wood akazie
bandeja de pizarra natural, madera de acacia
plateau ardoise naturelle, bois d'acacia



| | Ø cm | ↑ cm | ✱ mm |
|-------|--------------|------|-------|
| 00960 | 30 / 25 / 20 | 34 | 6 - 9 |

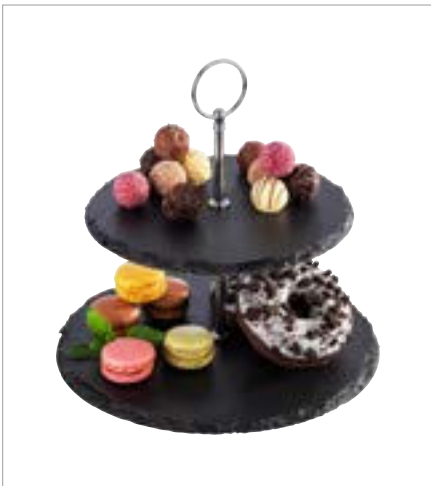

2-stufige Etagère

2-tier tray
bandeja dos alturas
étagère carré 2 hauteurs

Naturschiefer

natural slate tray
bandeja de pizarra natural
plateau ardoise naturelle



| | Ø cm | ↑ cm | ✱ mm |
|-------|---------|------|-------|
| 00989 | 25 / 20 | 24 | 6 - 9 |



Naturschieferplatte

natural slate tray
bandeja de pizarra natural
plateau ardoise naturelle

2-teilig: Naturschieferplatte mit Glashaube

2 pcs.: natural slate tray with glass cover
set de 2: bandeja de pizarra natural con tapa de cristal
set de 2: plateau ardoise naturelle avec cloche en verre

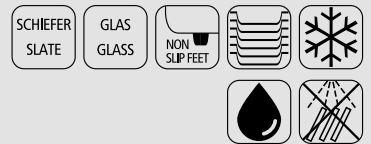

| | Ø cm | ↑ cm | ✱ mm |
|-------|------|------|-------|
| 00984 | 10,5 | 8 | 6 - 9 |



Naturschieferplatten, 4er Set

natural slate tray, 4 pcs.
bandeja pizarra natural, set de 4
plateau ardoise naturelle, set de 4



| | cm | ✱ mm | pcs. |
|-------|---------|-------|------|
| 00997 | 10 x 10 | 6 - 9 | 4 |



NEW

SQUARE



NEW



00758 GN 1/1

11075

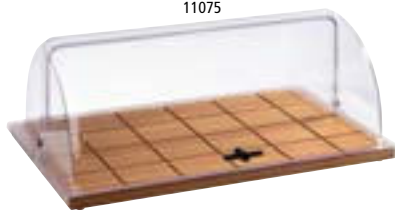

GN 1/1 Buffetbrett „SQUARE“

GN 1/1 buffet board
GN 1/1 tabla de buffet
GN 1/1 planche de buffet

aus geöltem Eichenholz
made of oiled oak wood
de madera de roble aceitada
en bois de chêne huilé



| | cm | ↑ cm | GN |
|-------|-------------|------|-----|
| 00758 | 53,0 x 32,5 | 2,5 | 1/1 |

passende Haube / suitable cover / campana adecuada / cloche appropriée

| | cm | ↑ cm | GN |
|-------|-------------|------|-----|
| 11075 | 53,0 x 32,5 | 19 | 1/1 |



Haube fixiert sich auf dem Brett, rutschfest
cover fixes itself on the board, non-slip

NEW



00759 GN 1/2

11073



GN 1/2 Buffetbrett „SQUARE“

GN 1/2 buffet board
GN 1/2 tabla de buffet
GN 1/2 planche de buffet

aus geöltem Eichenholz
made of oiled oak wood
de madera de roble aceitada
en bois de chêne huilé



| | cm | ↑ cm | GN |
|-------|-------------|------|-----|
| 00759 | 32,5 x 26,5 | 2,5 | 1/2 |

passende Haube / suitable cover / campana adecuada / cloche appropriée

| | cm | ↑ cm | GN |
|-------|---------|------|-----|
| 11073 | 33 x 28 | 17 | 1/2 |



Haube fixiert sich auf dem Brett, rutschfest
cover fixes itself on the board, non-slip



GN 2/4 Buffetbrett „SQUARE“

GN 2/4 buffet board
GN 2/4 tabla de buffet
GN 2/4 planche de buffet

aus geöltem Eichenholz
made of oiled oak wood
de madera de roble aceitada
en bois de chêne huilé



| | cm | ↑ cm | GN |
|-------|-------------|------|-----|
| 00760 | 53,0 x 16,2 | 2,5 | 2/4 |



Präsentationsmöglichkeit
presentation example

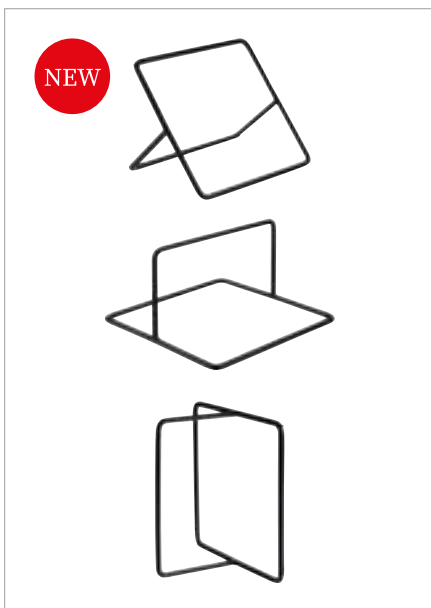

Buffetständer „SQUARE“

buffet stand
soporte para buffet
présentoir buffet

Metall, mit schwarzer Antirutschbeschichtung
metal, with black anti-slide coating
metal, con revestimiento antideslizante negro
métal, avec revêtement antidérapant noir



| | cm | ↑ cm |
|-------|---------|------|
| 33305 | 12 x 12 | 7 |



Präsentationsmöglichkeit | presentation example



Buffetbrett

buffet board
tabla de buffet
planche de buffet

für Karaffen, mit 3 Einsätzen Ø 11 cm aus Kunstleder, aus geöltem Eichenholz
for carafes, with 3 leatherette inserts Ø 11 cm, made of oiled oak wood
para jarras, con 3 inserciones de imitación de cuero Ø 11 cm, de madera de roble aceitada
pour pichets, avec 3 inserts en cuir synthétique Ø 11 cm, en bois de chêne huilé



| | cm | ↑ cm | Farbe / Colour |
|-------|---------|------|----------------|
| 11705 | 47 x 19 | 2 | natural oak |
| 11706 | 47 x 19 | 2 | dark oak |

passende Karaffe / suitable carafe / jarra a juego / pichet approprié

| | Ø cm | ↑ cm | ltr. |
|-------|------|------|------|
| 10690 | 9,5 | 31 | 1,0 |

6 Einsätze aus Kunstleder / 6 leatherette inserts / 6 inserciones de imitación de cuero / 6 inserts en cuir synthétique

| | Ø cm | Farbe / Colour | pcs. |
|-------|------|----------------|------|
| 35716 | 11 | anthracite | 6 |



Kunstledereinsatz herausnehmbar
removable leatherette insert

SERVING BOARDS



NEW



Servierbrett

serving board
 tabla de servir
 planche de service
 aus geöltem Akazienholz
 made of oiled acacia wood
 de madera de acacia aceitada
 en bois d'acacia huilé



| | cm | ↑ cm |
|-------|---------|------|
| 00793 | 25 x 17 | 1,5 |

NEW



Servierbrett

serving board
 tabla de servir
 planche de service
 aus geöltem Akazienholz
 made of oiled acacia wood
 de madera de acacia aceitada
 en bois d'acacia huilé



| | cm | ↑ cm |
|-------|--------|------|
| 00792 | 37 x 8 | 2 |



Präsentationsmöglichkeit
 presentation example

NEW



Servierschale

serving bowl
 cuenca de servir
 bol de service
 aus geöltem Akazienholz
 made of oiled acacia wood
 de madera de acacia aceitada
 en bois d'acacia huilé



| | cm | ↑ cm |
|-------|-----------|------|
| 00790 | 16,5 x 9 | 2 |
| 00791 | 23,5 x 13 | 2 |

SERVING BOARDS | WOOD



Servierbrett
serving board
tabla de servir
planche de service



2-teilig: 1 Holzbrett aus Akazienholz + 1 Naturschieferplatte

2 pcs.: 1 wood board made of acacia wood + 1 natural slate tray
set de 2: 1 tabla de madera de acacia + 1 pizarra natural
set de 2: 1 planche en bois d'acacia + 1 ardoise naturelle

| | cm | ↑ cm |
|-------|-----------|------|
| 00814 | 28 x 17,5 | 2 |



Servierbrett
serving board
tabla de servir
planche de service



2-teilig: 1 Holzbrett aus Akazienholz + 1 Naturschieferplatte

2 pcs.: 1 wood board made of acacia wood + 1 natural slate tray
set de 2: 1 tabla de madera de acacia + 1 pizarra natural
set de 2: 1 planche en bois d'acacia + 1 ardoise naturelle

| | cm | ↑ cm | Griff / handle cm |
|-------|---------|------|-------------------|
| 00810 | 26 x 18 | 2 | 8 |
| 00811 | 33 x 20 | 2 | 8 |
| 00812 | 40 x 15 | 2 | 5 |
| 00813 | 43 x 12 | 2 | 12 |

Präsentationsmöglichkeit
presentation example



mit Hängeloch Ø 2 cm / with a handle-hole Ø 2 cm

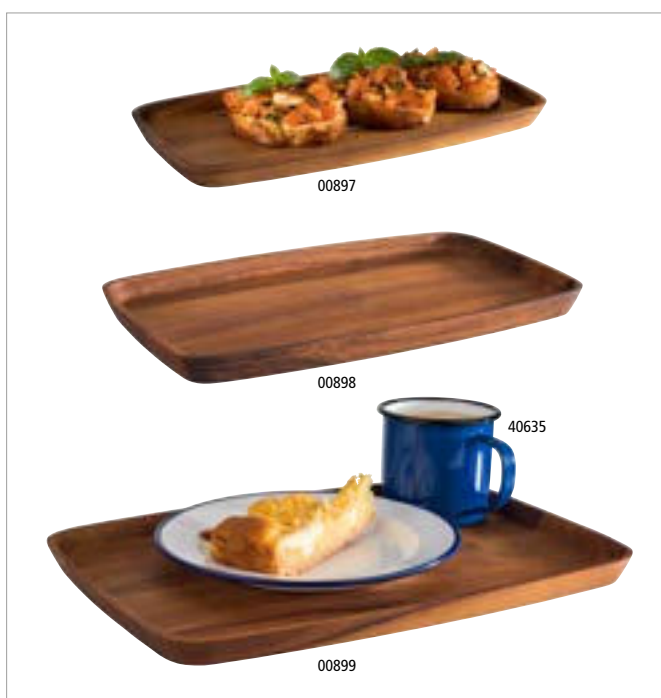

Servierbrett
serving board
tabla de servir
planche de service



Servierbrett aus geöltem Akazienholz

serving board made of oiled acacia wood
tabla de servir de madera de acacia aceitada
planche en bois avec plateau en bois d'acacia huilé

| | cm | ↑ cm |
|-------|---------|------|
| 00897 | 30 x 15 | 2 |
| 00898 | 30 x 18 | 2 |
| 00899 | 35 x 25 | 2 |



Servierbrett „SHARING“

serving board
tabla de servir
planche de service



Servierbrett aus geöltem Akazienholz

serving board made of oiled acacia wood
tabla de servir de madera de acacia aceitada
planche en bois d'acacia huilé

| | cm | ↑ cm | Griff / handle cm |
|-------|-----------|------|-------------------|
| 00887 | 51,5 x 18 | 1,5 | 8,5 |



Servierbrett „AKAZIE-SCHIEFER“

serving board
tabla de servir
planche de service



raffiniertes, rustikales Servierbrett aus Akazienholz,
ausgestattet mit einem Naturschieferstreifen zur Kennzeichnung

wood with slate, markable
madera con pizarra, se puede marcar
bois avec ardoise, on peut mettre une inscription

| | cm | ↑ cm | Griff / handle cm |
|-------|-----------|------|-------------------|
| 00867 | 30,5 x 13 | 1,5 | 10 |
| 00868 | 36,5 x 15 | 1,5 | 12 |
| 00869 | 42,0 x 18 | 1,5 | 14 |



Servierbrett „OLIVE“

serving board
tabla de servir en madera de olivo
planche de service en bois d'olivier



aus geöltem Olivenholz, mit 19 mm Aufhäng Bohrung, naturbe-
dingte Abweichung in Form, Maserung und Größe

oiled olive wood, natural deviation in shape, grain and size
de madera de olivo aceitada, diferencias naturales posibles en
forma, grano y tamaño
en bois d'olivier huilé, éventuelles différences naturelles de forme,
de grain et de taille

| | cm | ↑ cm | Griff / handle cm |
|-------|-----------|------|-------------------|
| 00870 | 25 x 17,0 | 1,5 | |
| 00871 | 30 x 20,5 | 2,0 | |
| 00873 | 40 x 15,0 | 1,5 | 11 |
| 00874 | 44 x 20,0 | 2,0 | 12 |
| 00875 | 19 x 12,5 | 1,5 | 6 |
| 00876 | 25 x 16,0 | 1,5 | 8 |
| 00877 | 31 x 20,0 | 1,5 | 9 |



Servierbrett „OLIVE“

serving board
tabla de servir
planche de service



aus geöltem Olivenholz, naturbedingte Abweichung in Form, Maserung und Größe

oiled olive wood, natural deviation in shape, grain and size

de madera de olivo aceitada, diferencias naturales posibles en forma, grano y tamaño

en bois d'olivier huilé, éventuelles différences naturelles de forme, de grain et de taille

| | cm | ↑ cm |
|-------|-------------|------|
| 00905 | 25,5 x 16,5 | 1,5 |
| 00906 | 35,0 x 20,5 | 1,5 |



Servier- und Tortenplatte

cake stand
porta pasteles
présentoir à gâteaux



Eichenholz geölt, mit Safrille

oak wood oiled, with juice groove

madera de roble aceitada, con ranura para líquidos

bois de chêne huilé, avec rigole

| | Ø cm | ↑ cm |
|-------|------|------|
| 00818 | 32 | 2,0 |



Präsentationsmöglichkeit
presentation example

passende Hauben / cover / campana / cloche



| | Ø cm | ↑ cm |
|-------|------|------|
| 06510 | 30 | 11,5 |
| 06512 | 30 | 11,5 |
| 06520 | 30 | 22 |



Servierbrett „OAK“

serving board
tabla de servir
planche de service



aus geöltem Eichenholz, Safrille, Ø 9,5 cm Aussparung

made of oiled oak, with juice groove, with hole Ø 9.5 cm

de madera de roble aceitada, con ranura para líquidos, con agujero Ø 9,5 cm

en bois chêne huilé, avec rigole, avec trou Ø 9,5 cm

| | cm | ↑ cm |
|-------|---------|------|
| 00808 | 37 x 25 | 2 |



mit Safrille
with juice groove

SERVING BOARD



Ø 6 cm



82316

beidseitig nutzbar
double-sided usable

Servierbrett

serving board
tabla de servir
planche de service

aus geöltem Eichenholz, mit 8 Vertiefungen Ø 6 cm

made of oiled oak wood, with 8 notches Ø 6 cm

de madera de roble aceitada con 8 ranuras Ø 6 cm

en bois de chêne huilé avec 8 encoches Ø 6 cm



| | cm | ↑ cm |
|-------|----------|------|
| 00809 | 100 x 14 | 1,5 |

Präsentationsmöglichkeit
presentation example



40636
Henkelbecher
beaker

mit Hängeloch Ø 2 cm / with a handle-hole Ø 2 cm



mit Hängeloch Ø 1,5 cm
with a handle-hole Ø 1,5 cm



Präsentationsmöglichkeit
presentation example

Servierbrett

serving board
tabla de servir
planche de service

aus geöltem Buchenholz mit Daumenmulde auf einer Seite

made of oiled beech wood with thumb recess on one side

de madera de haya aceitada con hueco para el pulgar en un lado

en bois de hêtre huilé avec encoche pour le pouce sur un côté



| | cm | ↑ cm |
|-------|-----------|------|
| 00817 | 60 x 19,5 | 2 |



Eiche, das widerstandsfähigste europäische Holz, ist seit jeher Ausdruck von Qualität, Kraft und Energie. Eichen werden uralt und riesengroß, sind unvergleichlich stark und standfest.

Oak, the most resistant European wood, has always been an expression of quality, strength and energy. Oaks grow to be ancient and huge, are incomparably strong and stable.

El roble, la madera europea más resistente, siempre ha sido una expresión de calidad, fuerza y energía. Los robles se vuelven antiguos y enormes, son incomparablemente fuertes y estables.

Le chêne, le bois européen le plus résistant, est depuis toujours l'expression de la qualité, de la force et de l'énergie. Les chênes deviennent très vieux et gigantesques, ils sont incomparablement forts et stables.



Servierbrett „SIMPLY WOOD“

servicing board
tabla de servir
planche de service



Eichenholz geölt, mit Aufhängeloch Ø 1,5 cm, mit Lederband

oak wood oiled, with handle hole Ø 1,5 cm, with leather strap
madera de roble aceitada, con agujero para colgar Ø 1,5 cm, con correa de cuero
bois de chêne huilé, avec trou de suspension Ø 1,5 cm, avec ruban en cuir

| | cm | ↑ cm | → Griff / handle |
|-------|---------|------|------------------|
| 00750 | 20 x 20 | 2 | 8 |
| 00751 | 27 x 17 | 2 | 8 |
| 00752 | 32 x 22 | 2 | 8 |



mit Lederband
with leather strap

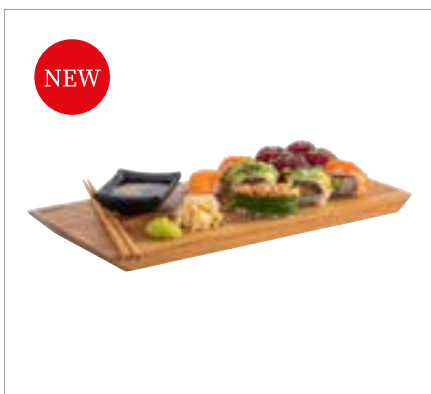

Tablett / Sushiboard „SIMPLY WOOD“

tray / sushiboard
bandeja para sushi
plateau sushi

aus geöltem Eichenholz
made of oiled oak wood
de madera de roble aceitada
en bois de chêne huilé



| | cm | ↑ cm |
|-------|---------|------|
| 00753 | 35 x 17 | 2 |

**GN 1/3 Servierbrett „SIMPLY WOOD“**

GN 1/3 serving board
GN 1/3 tabla de servir
GN 1/3 planche de service



Eichenholz geölt, mit Vertiefung Ø 4 cm, mit Safrinne

oak wood oiled, with notch Ø 4 cm, with juice groove
madera de roble aceitada, con ranura Ø 4 cm, con ranura para líquidos
bois de chêne huilé, mit avec encoche Ø 4 cm, avec rigole

| | cm | ↑ cm | GN |
|-------|-------------|------|-----|
| 00754 | 32,5 x 17,6 | 2 | 1/3 |

**Servierbrett**

serving board
tabla de servir
planche de service



Eichenholz, geölt, 2 Vertiefungen Ø 4,5 cm, 1 Vertiefung Ø 3 cm, mit 2 Griffmulden

oak wood oiled, 2 notches Ø 4,5 cm, 1 notch Ø 3 cm, with 2 recessed handles
madera de roble aceitada, 2 ranuras Ø 4,5 cm, 1 ranura Ø 3 cm, con 2 asas empotradas
bois de chêne huilé, 2 encoches Ø 4,5 cm, 1 encoche Ø 3 cm, avec 2 poignées encastrées

| | cm | ↑ cm |
|-------|--------|------|
| 00835 | 15 x 9 | 1,5 |

passende Gläser / fitting glasses / tarros de vidrio adecuados / verrines appropriées

| | Ø cm | ↑ cm | ltr. | pcs |
|-------|------|------|-------|-----|
| 82350 | 5,5 | 6 | 0,075 | 12 |
| 82351 | 5,5 | 9 | 0,145 | 12 |

**Servierbrett „PIZZA“**

serving board
tabla de servir
planche de service



Eichenholz geölt, mit Safrinne, mit 2 Griffmulden

oak wood oiled, with juice groove, with 2 recessed handles
madera de roble aceitada, con ranura para líquidos, con 2 asas empotradas
bois de chêne huilé, avec rainure à jus, avec 2 poignées encastrées

| | Ø cm | ↑ cm |
|-------|------|------|
| 00755 | 24 | 2 |
| 00756 | 29 | 2 |
| 00757 | 34 | 2 |



mit 2 Griffmulden an der Unterseite
with 2 recessed handles on the bottom

**Serviervablett**

serving tray
bandeja para servir
plateau de service



aus geöltem Eichenholz, mit 2 Griffmulden

made of oiled oak wood, with 2 recessed handles
de madera de roble aceitada, con 2 asas empotradas
en bois de chêne huilé, avec 2 poignées encastrées

| | cm | ↑ cm |
|-------|---------|------|
| 00761 | 45 x 35 | 6 |



Servierbrett „GENUSSPALETTE“

serving board
tabla de servir
planche de service

Genusspalette im Kleinformat, Birke
mini serving palett, birch
tabla de servir, formato pequeño, abedul
planche de service, petit format, bouleau



| | cm | ↑ cm |
|-------|---------|------|
| 00880 | 20 x 12 | 3 |
| 00881 | 30 x 20 | 3 |
| 00882 | 40 x 15 | 3 |



Table Caddy „OLIVE“

table barrel
caddy de mesa
caddy de table

aus geöltem Olivenholz
oiled olive wood
de madera de olivo aceitada
en bois d'olivier huilé



| | cm | ↑ cm |
|-------|---------|------|
| 01016 | 22 x 15 | 6 |
| 01017 | 25 x 18 | 6 |



Allzweckstreuer, 12 er Set / shaker, 12 pcs. / dosificador, set de 12 / salières/poivrières set de 12

| | cm | ↑ cm | ltr. |
|-------|-------|------|------|
| 40504 | 4 x 4 | 10 | 0,07 |

passende Brottasche / suitable bread basket / panera a juego / corbeilla assortie

| | cm | ↑ cm | Farbe / Colour |
|-------|-----------|------|----------------|
| 30356 | 12 x 11,5 | 11,5 | ■ |

passende Mühlen / suitable mills/ molinos de ajuste / moulins assortis

| | ø cm | ↑ cm |
|-------|------|------|
| 40555 | 6 | 15,5 |
| 40556 | 6 | 15,5 |



Wachspapier „SNACKHOLDER“

greaseproof paper squares
papel alimenticio
papier alimentaire



| | cm | pcs. | Motiv: Zeitung |
|-------|---------|------|----------------|
| 40670 | 42 x 25 | 500 | |



01010

0,15 ltr.



01011

0,25 ltr.



01012

0,50 ltr.

Schale „OLIVE“bowl
cuenco
bol

aus geöltem Olivenholz, naturbedingte Abweichung in Form, Maserung und Größe

oiled olive wood, natural deviation in shape, grain and size

de madera de olivo aceitada, diferencias naturales posibles en forma, grano y tamaño
en bois d'olivier huilé, éventuelles différences naturelles de forme, de grain et de taille

| | Ø cm | ↑ cm | ltr. |
|-------|------|------|------|
| 01010 | 10,0 | 4,0 | 0,15 |
| 01011 | 12,5 | 4,5 | 0,25 |
| 01012 | 15,0 | 6,0 | 0,50 |

3 Größen ineinander
3 sizes in each other

00843

0,05 ltr.



00844

0,10 ltr.

Schale „OLIVE“bowl
cuenco
bol

aus geöltem Olivenholz, naturbedingte Abweichung in Form, Maserung und Größe

oiled olive wood, natural deviation in shape, grain and size

de madera de olivo aceitada, diferencias naturales posibles en forma, grano y tamaño
en bois d'olivier huilé, éventuelles différences naturelles de forme, de grain et de taille

| | cm | ↑ cm | ltr. |
|-------|------------|------|------|
| 00843 | 12,0 x 7,5 | 2,5 | 0,05 |
| 00844 | 16,5 x 9,5 | 2,5 | 0,10 |



00907

0,20 ltr.



00908

0,30 ltr.



01023

0,40 ltr.

Schale „OLIVE“bowl
cuenco
bol

aus geöltem Olivenholz, naturbedingte Abweichung in Form, Maserung und Größe

oiled olive wood, natural deviation in shape, grain and size

de madera de olivo aceitada, diferencias naturales posibles en forma, grano y tamaño
en bois d'olivier huilé, éventuelles différences naturelles de forme, de grain et de taille

| | cm | ↑ cm | ltr. |
|-------|----------|------|------|
| 00907 | 13 x 8 | 6,5 | 0,2 |
| 00908 | 16 x 9 | 7,0 | 0,3 |
| 01023 | 25 x 8,5 | 7,5 | 0,4 |



Schale „OLIVE“

bowl
cuenco
bol



aus geöltem Olivenholz
oiled olive wood
de madera de olivo aceitada
en bois d'olivier huilé

| | cm | ↑ cm | ltr. |
|-------|-------------|------|------|
| 01013 | 7,5 x 7,5 | 2,5 | 0,05 |
| 01014 | 17,5 x 8,5 | 2,5 | 0,15 |
| 01015 | 26,5 x 11,5 | 5,0 | 0,60 |



Servierbeispiel - Lieferung ohne Gläser
delivery without glasses

Holzbox „TABLE“

woodbox
caja madera
base bois



Akazienholz, 3 Fächer (6,5 x 6,5 cm) / acacia wood, 3 compartments (6,5 x 6,5 cm) / madera de acacia, 3 compartimentos (6,5 x 6,5 cm) / bois d'acacia, 3 compartiments (6,5 x 6,5 cm)

| | cm | ↑ cm | inner size cm |
|-------|------------|------|--------------------------------------|
| 11727 | 23,5 x 8,5 | 4,5 | 6,5 x 6,5 je Fach / each compartment |



Servierbeispiel - Lieferung ohne Gläser
delivery without glasses

Servierbrett „NARROW I“

servicing board
tabla de servir
planche de service



Akazienholz, mit 3 Vertiefungen Ø 4 cm / acacia wood, with 3 notches Ø 4 cm
madera de acacia, con 3 ranuras Ø 4 cm / bois d'acacia, avec 3 encoches Ø 4 cm

| | cm | ↑ cm |
|-------|--------|------|
| 00864 | 22 x 8 | 1,5 |

passende Schälchen / fitting bowls / cuencos adecuados / bols appropriés

| | Ø cm | ↑ cm | ltr. | |
|-------|------|------|------|-----------------|
| 82312 | 6 | 5,5 | 0,08 | glass / 12 pcs |
| 40685 | 6 | 3,0 | 0,05 | stainless steel |



Servierbeispiel - Lieferung ohne Schälchen
delivery without bowls

Servierbrett „NARROW II“

servicing board
tabla de servir
planche de service



Akazienholz, mit 3 Vertiefungen Ø 6 cm
acacia wood, with 3 notches Ø 6 cm
madera de acacia, con 3 ranuras Ø 6 cm
bois d'acacia, avec 3 encoches Ø 6 cm

| | cm | ↑ cm |
|-------|---------|------|
| 00878 | 31 x 11 | 2 |

passende Schälchen / fitting bowls / cuencos adecuados / bols appropriés

| | Ø cm | ↑ cm | ltr. | |
|-------|------|------|------|-----------------|
| 40686 | 8 | 4,5 | 0,17 | stainless steel |

BUFFET BOARDS „PROFI“



06512

Ø 33 cm

00805



06521

Ø 39 cm

00816

Buffetbrett „PROFI“

buffet board
tabla de buffet
planche de buffet

aus geöltem Eichenholz, Safrinne, mit Antirutschfüßchen

made of oiled oak, with juice groove and non-slip feet

de madera de roble aceitada, con ranura para líquidos y pies antideslizantes

en bois chêne huilé, avec rigole et pieds antidérapants



| | Ø cm | ↑ cm |
|-------|------|------|
| 00805 | 33 | 4,5 |
| 00816 | 39 | 4,5 |

Frischhaltehaube / cover / campana / cloche



| | Ø cm | ↑ cm | fits to |
|-------|------|------|---------|
| 06512 | 30 | 11,5 | 00805 |

Frischhaltehaube / cover / campana / cloche



| | Ø cm | ↑ cm | fits to |
|-------|------|------|---------|
| 06519 | 21 | 17 | 00815 |
| 06520 | 30 | 22 | 00805 |
| 06521 | 36 | 27 | 00816 |



00807



00806

11016
GN 1/1

00806

Buffetbrett „PROFI“

buffet board
tabla de buffet
planche de buffet

aus geöltem Eichenholz, Safrinne, mit Antirutschfüßchen

made of oiled oak, with juice groove and non-slip feet

de madera de roble aceitada, con ranura para líquidos y pies antideslizantes

en bois chêne huilé, avec rigole et pieds antidérapants



| | cm | ↑ cm |
|-------|-----------|------|
| 00807 | 38 x 32,0 | 4,5 |
| 00806 | 58 x 37,5 | 4,5 |

Rolltophaube / rolltop cover / campana rolltop / cloche rolltop



| | Ø cm | ↑ cm | fits to | GN |
|-------|-------------|------|---------|-----|
| 11016 | 53,0 x 32,5 | 19 | 00806 | 1/1 |



CUTTING BOARDS



Brottschneidebrett

cutting board
tabla de cortar
planche à découper

Walnussholz / walnut wood / mader de nogal / bois de noyer



| | cm | ↑ cm | GN |
|-------|-------------|------|-----|
| 00911 | 35,4 x 32,5 | 3,5 | 2/3 |



praktisches Krümelfach
practical crump shelf



praktisches Krümelfach
practical crump shelf

Brottschneidebrett „LETTER“

cutting board
tabla de cortar
planche à découper

Akazienholz / acacia wood / mader de acacia / bois d'acacia



| | cm | ↑ cm | |
|-------|---------|------|--|
| 00886 | 48 x 34 | 3,5 | |



00885

Brottschneidebrett

cutting board
tabla de cortar
planche à découper

Akazienholz / acacia wood / mader de acacia / bois d'acacia



| | cm | ↑ cm | GN |
|-------|-------------|------|-----|
| 00883 | 47,5 x 32,0 | 2 | |
| 00884 | 53,0 x 32,5 | 2 | 1/1 |
| 00885 | 60,0 x 40,0 | 2 | |



praktisches Krümelfach
practical crump shelf



Brottschneidebrett

cutting board
tabla de cortar
planche à découper

Rubberwood / rubberwood / mader de caucho / bois d'hévéa



| | cm | ↑ cm | GN |
|-------|-------------|------|-----|
| 00955 | 47,5 x 32,0 | 2 | |
| 00956 | 53,0 x 32,5 | 2 | 1/1 |
| 00957 | 60,0 x 40,0 | 2 | |



praktisches Krümelfach
practical crump shelf

**Serviertablett „HAPPY HOUR“**

tray
bandeja
plateau

rutschfeste Oberfläche
non-slip surface
superficie antideslizante
surface antidérapante



| | Ø cm | ↑ cm | Farbe / Colour |
|-------|------|------|----------------|
| 00510 | 32 | 1,5 | ■ |
| 00511 | 38 | 1,5 | ■ |
| 00515 | 43 | 1,5 | ■ |

**Bierglasträger „NON SLIP“**

beer rack
bandeja para cerveza
porte verre à bière

rutschfeste Oberfläche
non-slip surface
superficie antideslizante
surface antidérapante



| | Ø cm | ↑ cm | Farbe / Colour |
|-------|---------|------|----------------|
| 00500 | 36 | 3,5 | ■ |
| 00506 | 28 x 20 | 1,5 | ■ |

**Tablett „GASTRO“**

tray
bandeja
plateau

rutschfeste Oberfläche
non-slip surface
superficie antideslizante
surface antidérapante



| | Ø cm | ↑ cm | Farbe / Colour |
|-------|------|------|----------------|
| 00547 | 27,5 | 2 | ■ |
| 00548 | 35,5 | 2 | ■ |
| 00549 | 40,5 | 2 | ■ |

**Tablett „BISTRO“**

tray
bandeja
plateau

rutschfest, mit 2 Griffmulden und Stapelrand
non-slip, two open handles, stackable edge
antideslizante, con 2 asas y borde apilable
antidérapant, avec 2 poignées et bord d'empilage



| | Ø cm | ↑ cm | Farbe / Colour |
|-------|------|------|----------------|
| 84045 | 35,5 | 4,5 | ■ |

TRAYS



Serviertablett „NON SLIP“

tray non-slip
bandeja
plateau

rutschfeste Oberfläche
non-slip surface
superficie antideslizante
surface antidérapante



| | cm | ↑ cm | GN | Farbe / Colour |
|-------|-------------|------|-----|----------------|
| 00502 | 53,0 x 32,5 | 1,5 | 1/1 | — |
| 00508 | 46,0 x 36,0 | 2,0 | | — |



Tablett

tray
bandeja
plateau

rutschfest, Holzdekor-Laminat
non-slip, coated wood
antideslizante, decoración madera láminae
antidérapant, décor bois laminé



| | cm | ↑ cm |
|-------|-------------|------|
| 00524 | 43,5 x 31,5 | 1,5 |
| 00525 | 52,0 x 39,0 | 1,5 |
| 00526 | 60,5 x 42,5 | 1,5 |



Tablett

tray
bandeja
plateau

rutschfest, Mahagonifurnier
non-slip, woodform, mahogany
antideslizante, revestimento de caoba
antidérapant, placage en acajou



| | Ø cm | ↑ cm | |
|-------|------|------|------------|
| 00528 | 31,0 | 3,5 | hoher Rand |
| 00529 | 35,5 | 3,5 | hoher Rand |



Tablett

tray
bandeja
plateau

rutschfest, Holzdekor-Laminat
non-slip, coated wood
antideslizante, limando decoracion maderas
antidérapant, décor bois stratifié



| | cm | ↑ cm |
|-------|---------|------|
| 00521 | 26 x 20 | 1 |
| 00522 | 29 x 21 | 1 |

FAST FOOD TRAYS



Fast Food-Tablett
 snack tray
 bandeja autoservicio y snacks
 plateau self-service et snacks



00535



00536



00537



00538



00534



00539

| | cm | ↑ cm | GN | Farbe / Colour |
|-------|-----------|------|-----|----------------|
| 00530 | 35 x 27,0 | 2 | | |
| 00535 | 41 x 30,5 | 2 | | |
| 00540 | 45 x 35,5 | 2 | | |
| 00552 | 53 x 32,5 | 2 | 1/1 | |

| | cm | ↑ cm | GN | Farbe / Colour |
|-------|-----------|------|-----|----------------|
| 00531 | 35 x 27,0 | 2 | | |
| 00536 | 41 x 30,5 | 2 | | |
| 00541 | 45 x 35,5 | 2 | | |
| 00553 | 53 x 32,5 | 2 | 1/1 | |

| | cm | ↑ cm | GN | Farbe / Colour |
|-------|-----------|------|-----|----------------|
| 00532 | 35 x 27,0 | 2 | | |
| 00537 | 41 x 30,5 | 2 | | |
| 00542 | 45 x 35,5 | 2 | | |
| 00554 | 53 x 32,5 | 2 | 1/1 | |

| | cm | ↑ cm | GN | Farbe / Colour |
|-------|-----------|------|-----|----------------|
| 00533 | 35 x 27,0 | 2 | | |
| 00538 | 41 x 30,5 | 2 | | |
| 00543 | 45 x 35,5 | 2 | | |
| 00555 | 53 x 32,5 | 2 | 1/1 | |

| | cm | ↑ cm | GN | Farbe / Colour |
|-------|-----------|------|----|----------------|
| 00534 | 35 x 27,0 | 2 | | |

| | cm | ↑ cm | GN | Farbe / Colour |
|-------|-----------|------|----|----------------|
| 00539 | 35 x 27,0 | 2 | | |



stapelbar
 stackable

CAKE STANDS



Servier- und Tortenplatte „CASUAL“
 cake plate
 porta pasteles
 présentoir à gâteaux



| | Ø cm | ↑ cm |
|-------|---------|------|
| 83890 | 31 | 8 |
| 83891 | 31 | 16 |
| | cm | ↑ cm |
| 83892 | 31 x 31 | 8 |
| 83893 | 31 x 31 | 16 |



Servier- und Tortenplatte
 cake stand
 porta pasteles
 présentoir à gâteaux



Rand fixiert die Haube, mit Antirutschfüßchen

carved edge fixes the cover, with non-slip feet

ranura para fijar bien la campana, con pies antideslizantes

bord rainuré pour maintenir ferme la cloche, avec pieds antidérapants



| | Ø cm | ↑ cm | Farbe / Colour | fits to cover |
|-------|------|------|----------------|---------------|
| 00468 | 31 | 3,5 | White | 06520 |
| 00469 | 31 | 3,5 | Black | 06520 |



Servier- und Tortenplatte
 cake stand
 porta pasteles
 présentoir à gâteaux



Eichenholz geölt, mit Safrinne

oak wood oiled, with juice groove

madera de roble aceitada, con ranura para líquidos

bois de chêne huilé, avec rigole

| | Ø cm | ↑ cm |
|-------|------|------|
| 00818 | 32 | 2,0 |

passende Hauben / suitable for covers / campanas adecuadas / cloches appropriées

| | Ø cm | ↑ cm |
|-------|------|------|
| 06520 | 30 | 22 |
| 06510 | 30 | 11,5 |



Servier- und Tortenplatte „ACACIA“

cake stand
porta pasteles
présentoir à gâteaux

Akazienholz geölt, möbelschonende Unterseite
acacia wood oiled, furniture-friendly underside
madera de acacia aceitada, con base anti rayaduras
bois d'acacia huilé, avec revêtement antirayures



| | Ø cm | ↑ cm |
|-------|------|------|
| 33292 | 24,0 | 8 |
| 33293 | 24,0 | 16 |
| 33294 | 33,0 | 8 |
| 33295 | 33,0 | 16 |
| 33296 | 38,5 | 8 |
| 33297 | 38,5 | 16 |



mit Rille
with groove

Frischhaltehaube / cover / campana / cloche



| | Ø cm | ↑ cm | fits to |
|-------|------|------|--------------|
| 06519 | 21 | 17 | 33292, 33293 |
| 06520 | 30 | 22 | 33294, 33295 |
| 06521 | 36 | 27 | 33296, 33297 |



drehbar
rotating

Servier- und Tortenplatte

cake stand
porta pasteles
présentoir à gâteaux

matt poliert, drehbar, möbelschonende Unterseite
matt polished, rotating, furniture-friendly underside
pulido mate, giratoria, con base anti rayaduras
poli mat, pivotant, avec revêtement antirayures



| | Ø cm | ↑ cm |
|-------|------|------|
| 00463 | 30,5 | 9 |



Servier- und Tortenplatte

cake stand
porta pasteles
présentoir à gâteau

matt poliert / matt polished / pulido mate / poli mat



| | Ø cm | ↑ cm |
|-------|------|------|
| 00046 | 31 | 3 |



Auslagen- / Kuchenplatte

display / cake plate
expositor / plato para tartas
présentoir / assiette à gâteau

ideale Größe für Baumkuchen / Stollen
ideal size for Baumkuchen / Stollen
tamaño ideal para Baumkuchen / Stollen
taille idéale pour Baumkuchen / Stollen



| | cm | ↑ cm |
|-------|---------|------|
| 00047 | 40 x 16 | 2,5 |

SUPER DOME



06525 Ø 30 cm

Frischhaltehaube „SUPER DOME“

cover
campana
cloche



schwere, glasklare Qualität
stable, crystal clear quality
muy resistente y transparencia cristalina
haute résistance et transparence

| | Ø cm | ↑ cm |
|-------|------|------|
| 06525 | 30 | 40 |

passende Servier-/Tortenplatten / suitable cake stands / porta pasteles compatibles / présentoirs à gâteaux compatibles

| | Ø cm | ↑ cm | fits to | Farbe / Colour |
|-------|------|------|---------|----------------|
| 00468 | 31,0 | 3,5 | 06525 | |
| 33294 | 33,0 | 8,0 | 06525 | |
| 33295 | 33,0 | 16,0 | 06525 | |

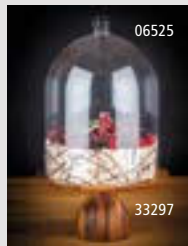

Präsentationsmöglichkeiten
presentation examples



Ø 21cm

tray
84942

Frischhaltehaube

cover
campana
cloche



schwere, glasklare Qualität
stable, crystal clear quality
calidad estable y transparencia cristalina
qualité stable et clarté cristalline

| | Ø cm | ↑ cm | fits to |
|-------|------|------|--|
| 06519 | 21 | 17 | 84941, 84942 |
| 06520 | 30 | 22 | 85034, 84177, 83891, 83890, 83884, 998, 975, 469, 468, 463, 462, 46 |
| 06521 | 36 | 27 | 84945, 84946 |

**Besteckbehälter**

cutlery box
recipiente para cubiertos
récipient pour couverts

Akazienholz, 4 Fächer (26 x 11,5 cm)

acacia wood, 4 compartments (26 x 11,5 cm)
madera de acacia, 4 compartimentos (26 x 11,5 cm)
bois d'acacia, 4 compartiments (26 x 11,5 cm)



| | cm | ↑ cm | Farbe / Colour | |
|-------|---------|------|----------------|---------------|
| 11952 | 51 x 28 | 13 | | nature |
| 11951 | 51 x 28 | 13 | | vintage white |

**Besteckbehälter mit Deckel**

cutlery box with cover
caja de cubiertos con tapa
range-couverts avec couvercle

Akazienholz, 4 Fächer (26 x 11,5 cm), mit Deckel

acacia wood, 4 compartments (26 x 11,5 cm), with cover
madera de acacia, 4 compartimentos (26 x 11,5 cm), con tapa
bois d'acacia, 4 compartiments (26 x 11,5 cm), avec couvercle



| | cm | ↑ cm | Farbe / Colour | |
|-------|---------|------|----------------|---------------|
| 11949 | 51 x 28 | 14,5 | | nature |
| 11948 | 51 x 28 | 14,5 | | vintage white |

**GN 1/1 Besteckbehälter**

GN 1/1 dispenser GN
GN 1/1 dispensador de cubiertos
GN 1/1 bac à couverts

in Handarbeit geflochten, 4 Mulden, Kunststoff-Geflecht, Drahtgestell, braun-schwarz

hand-woven, 4 troughs, plastic wickerwork, wire frame, brown-black
cesta trensada a mano, 4 compartimentos, mimbre de plástico, marco de alambre, marrón-negro
corbeille tressée à main, 4 compartiments, plastique tressé, armature en fil métallique, brun-noir



| | cm | ↑ cm | Farbe / Colour | GN |
|-------|-----------|------|----------------|-----|
| 11966 | 53 x 32,5 | 9 | | 1/1 |

**GN 1/1 Besteckbehälter**

GN 1/1 cutlery dispenser
GN 1/1 dispensador de cubiertos
GN 1/1 bac à couverts

4 Mulden, Kunststoff-Geflecht, Drahtgestell, beige

4 troughs, plastic wickerwork, wire frame, beige
4 compartimentos, mimbre de plástico, marco de alambre, beige
4 compartiments, plastique tressé, structure métallique, beige



| | cm | ↑ cm | Farbe / Colour | GN |
|-------|-----------|------|----------------|-----|
| 11965 | 53 x 32,5 | 10 | | 1/1 |

CUTLERY BOXES



GN 1/1 Besteckbehälter

GN 1/1 cutlery bin
GN 1/1 recipiente para cubiertos
GN 1/1 récipients pour couverts



4 Mulden

4 troughs
4 compartimentos
4 compartiments

| | cm | ↑ cm | Farbe / Colour | GN |
|-------|-----------|------|----------------|-----|
| 11954 | 53 x 32,5 | 10 | ■ | 1/1 |
| 11955 | 53 x 32,5 | 10 | ■ | 1/1 |

3 Mulden, 3 Köcher

3 troughs, 3 cutlery baskets
3 compartimentos, 3 cestas para cubiertos
3 compartiments, 3 corbeilles à couverts

| | cm | ↑ cm | Farbe / Colour | GN |
|-------|-----------|------|----------------|-----|
| 11960 | 53 x 32,5 | 10 | ■ | 1/1 |



Besteckbehälter

cutlery basket
recipiente para cubiertos
récipients pour couverts



4 Löcher inklusive 4 Edelstahl Köcher

4 holes including 4 stainless baskets
4 agujeros con 4 cestas de acero inoxidable
4 trous avec 4 corbeilles en acier inox

| | cm | ↑ cm | Farbe / Colour |
|-------|---------|------|----------------|
| 93321 | 27 x 27 | 15 | ■ |



Besteckköcher

cutlery basket
cesta para cubiertos
corbeille à couverts



Polyethylen weiß / polyethylene white plastic / polietileno blanco / polyéthylène blanc

| | Ø cm | ↑ cm |
|-------|------|------|
| 11998 | 9,5 | 13,5 |

Edelstahl matt poliert / stainless steel matt polished / acero inoxidable pulido mate / acier inox poli mat

| | Ø cm | ↑ cm |
|-------|------|------|
| 11999 | 9,5 | 13,5 |



Besteckkasten „INDUSTRIAL“

cutlery box
caja para cubiertos
boîte pour couverts



Metall, schwarz

metal, black
metal, negro
métal, noir

| | cm | ↑ cm | litr. |
|-------|-------------|------|-------|
| 40676 | 23,0 x 15,5 | 13,0 | 2,4 |



NAPKIN HOLDERS



Serviettenhalter

napkin holder
servilletero
porte-serviettes

matt poliert / matt polished / pulido mate / poli mat



| | cm | ↑ cm |
|-------|---------|------|
| 11730 | 17 x 17 | 5 |



Serviettenhalter

napkin holder
servilletero
porte-serviettes

hochglanzpoliert, für Servietten mit 1/8 Falz, Füße mit rutsch- und kratzester Gummierung
mirror polished, for napkins with 1/8 fold, feet with non-slip and scratch-resistant rubber coating

pulido brillante, para servilletas plegado 1/8, pies con revestimiento de goma antideslizante y anti rayaduras

poli brillant, pour serviettes pliage 1/8, pieds avec caoutchouc antidérapant et antirayures



| | cm | ↑ cm |
|-------|-----------|------|
| 11720 | 10 x 11,5 | 18,5 |



11767

Serviettenhalter „HERO“

napkin holder
servilletero
porte-serviettes

für ca. 65 Cocktailservietten, inklusive Beschwerer

for approx. 65 cocktail napkins, including weight

para aprox. 65 servilletas cocktail, con barrita de contrapeso

pour environ 65 serviettes cocktail, avec barre de contrepoids



| | cm | ↑ cm |
|-------|-------------|------|
| 11767 | 14,5 x 14,5 | 10 |

für ca. 95 Servietten 1/4 Falz, inklusive Beschwerer

for approx. 95 napkins 1/4 fold, including weight

para aprox. 95 servilletas de plegado 1/4, con barrita de contrapeso

pour environ 95 serviettes pliage 1/4, avec barre de contrepoids

| | cm | ↑ cm |
|-------|-------------|------|
| 11768 | 18,5 x 18,5 | 14 |



11768



inklusive Beschwerer
including weight

NAPKIN HOLDERS

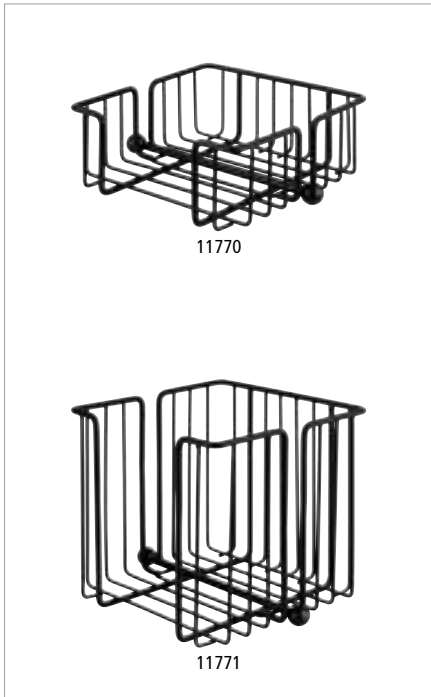

Serviettenhalter „URBAN“

napkin holder
servilletero
porte-serviettes

für ca. 50 Servietten 1/4 Falz, inklusive Beschwerer

for approx. 50 napkins 1/4 fold, including weight
para aprox. 50 servilletas de plegado 1/4, con barra de contrepeso
pour environ 50 serviettes pliage 1/4, avec barre de contrepoids



cm ↑ cm

11770 19 x 19 7,5

für ca. 120 Servietten 1/4 Falz, inklusive Beschwerer

for approx. 120 napkins 1/4 fold, including weight
para aprox. 120 servilletas de plegado 1/4, con barra de contrepeso
pour environ 120 serviettes pliage 1/4, incl. barrie de contrepoids

cm ↑ cm

11771 19 x 19 18



inklusive Beschwerer
including weight

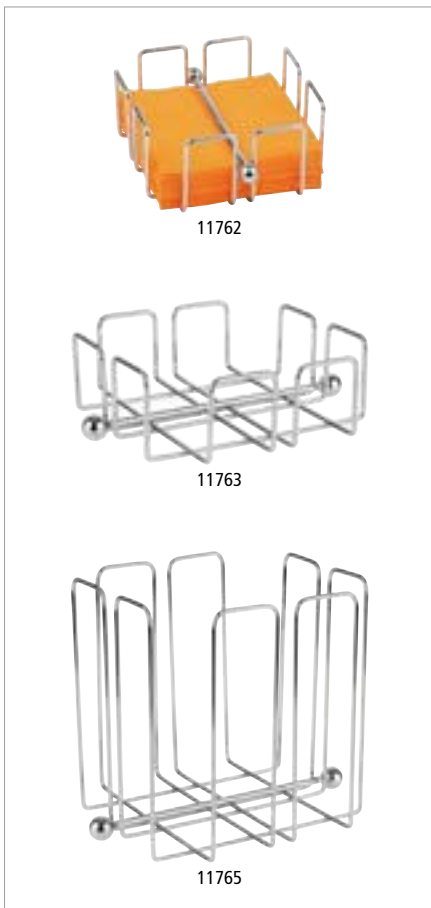

Serviettenhalter „WIRE“

napkin holder
servilletero
porte-serviettes

für ca. 50 Cocktailservietten, inklusive Beschwerer

for approx. 50 cocktail napkins, including weight
para aprox. 50 servilletas cocktail, con barra de contrepeso
pour environ 50 serviettes cocktail, avec barre de contrepoids



cm ↑ cm

11762 14 x 14 6,5

für 50 Servietten 1/4 Falz, inklusive Beschwerer

for 50 napkins 1/4 fold, including weight
para 50 servilletas plegado 1/4, con barra de contrepeso
pour 50 serviettes pliage 1/4, avec barre de contrepoids

cm ↑ cm

11763 19 x 19 6,5

für 150 Servietten 1/4 Falz, inklusive Beschwerer

for 150 napkins 1/4 fold, including weight
para 150 servilletas plegado 1/4, con barra de contrepeso
pour 150 serviettes pliage 1/4, avec barre de contrepoids

cm ↑ cm

11765 19 x 19 19,0



inklusive Beschwerer
including weight



Serviettenhalter

napkin holder
servilletero
porte-serviettes

möbelschonende Unterseite, für ca. 20 Servietten, matt poliert

furniture-friendly underside, for approx. 20 napkins, matt polished
con base anti rayaduras, para aprox. 20 servilletas, pulido mate
avec revêtement antirayures, pour environ 20 serviettes, poli mat



cm ↑ cm

11778 17 x 3 7



Serviettenhalter

napkin holder
servilletero
porte-serviettes



möbelschonende Unterseite, für ca. 30 Servietten, matt poliert
furniture-friendly underside, for approx. 30 napkins, matt polished
con base anti rayaduras, para aprox. 30 servilletas, pulido mate
avec revêtement antirayures, pour environ 30 serviettes, poli mat

| | cm | ↑ cm |
|-------|----------|------|
| 11780 | 15 x 4,5 | 12,5 |



Serviettenhalter „ELEMENT“

napkin holder
servilletero
porte-serviettes



aus Beton, für ca. 50 Servietten, möbelschonende Unterseite
concrete, for approx. 50 napkins, furniture-friendly underside
hormigón, para aprox. 50 servilletas, con base anti rayaduras
béton, pour environ 50 serviettes, avec revêtement antirayures

| | cm | ↑ cm |
|-------|----------|------|
| 11781 | 16 x 7,5 | 10 |



Table Caddy „ELEMENT“

table caddy
caddy de mesa
caddy de table



aus Beton, möbelschonende Unterseite
concrete, furniture-friendly underside
hormigón, con base anti rayaduras
béton, avec revêtement antirayures

| | cm | ↑ cm | inner size cm |
|-------|-----------|------|---------------|
| 11647 | 16,5 x 16 | 6,5 | 14,5 x 14 |



Table Caddy „ELEMENT“

table caddy
caddy de mesa
caddy de table



Beton, möbelschonende Unterseite, 2 Löcher je 6,5 cm
concrete, furniture-friendly underside, 2 holes each 6.5 cm
hormigón, con base anti rayaduras, 2 agujeros cada uno 6,5 cm
béton, avec revêtement antirayures, 2 trous de 6,5 cm chacun

| | cm | ↑ cm | inner size cm |
|-------|-----------|------|---------------|
| 11648 | 23,5 x 16 | 6,5 | 14,5 x 14 |



Buffet & Tableware Melamine



| | | | |
|-----------------------|-----|------------------------|-----|
| NERO..... | 144 | CIRCLE LA VIDA..... | 189 |
| CANCUN..... | 147 | MARONE..... | 190 |
| LOOPS..... | 148 | DARK WAVE..... | 193 |
| MOON..... | 150 | ZEN..... | 195 |
| EMMA..... | 152 | SINUS..... | 199 |
| APS+..... | 154 | HALFTONE..... | 200 |
| ASIA+..... | 155 | APART CASCADE..... | 202 |
| BLUE OCEAN..... | 159 | GLOBAL BUFFET..... | 203 |
| ARABESQUE..... | 161 | FLYING BUFFET..... | 204 |
| BAMBOO..... | 163 | FLOAT..... | 205 |
| STONE ART..... | 164 | PURE..... | 207 |
| AIKO..... | 167 | ENAMEL LOOK..... | 211 |
| ELEMENT..... | 168 | CASUAL..... | 212 |
| TIMBER..... | 171 | NATURAL COLLECTION.... | 214 |
| OAK..... | 172 | BRÖTCHENSCHÜTTE..... | 215 |
| OAK LIGHT..... | 173 | CASUAL SEAFOOD..... | 216 |
| GLAMOUR..... | 174 | BALANCE..... | 217 |
| CROCKER..... | 175 | CUTLERY REST..... | 218 |
| FRIDA..... | 177 | PARTY SPOON..... | 219 |
| SLATE..... | 185 | MINI..... | 221 |
| SLATE ROCK..... | 187 | GN CONTAINER..... | 224 |
| ZERO DRIFTWOOD..... | 188 | | |



NERO



85067 GN 1/1

85068 GN 1/2

GN Tablett „NERO“

GN tray
GN bandeja
GN plateau



| | cm | ↑ cm | GN |
|-------|-------------|------|-----|
| 85067 | 53,0 x 32,5 | 2,5 | 1/1 |
| 85068 | 32,5 x 26,5 | 2,5 | 1/2 |

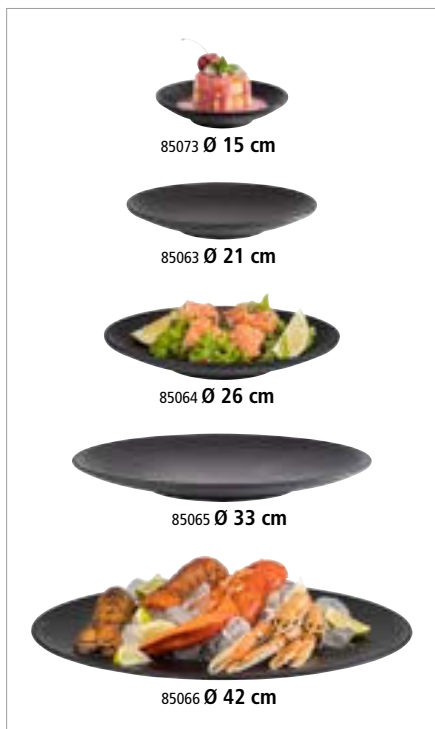
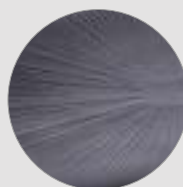

85073 Ø 15 cm

85063 Ø 21 cm

85064 Ø 26 cm

85065 Ø 33 cm

85066 Ø 42 cm

Teller „NERO“

plate
plato
assiette



| | Ø cm | ↑ cm |
|------------------|------|------|
| 85073 NEW | 15 | 3 |
| 85063 | 21 | 3 |
| 85064 | 26 | 3 |
| 85065 | 33 | 3,5 |
| 85066 | 42 | 3,5 |

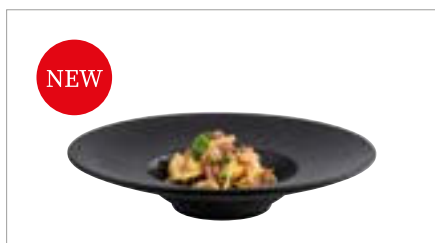

NEW

Teller „NERO“

plate
plato
assiette



| | Ø cm | ↑ cm | ltr. |
|-------|------|------|------|
| 85098 | 29 | 6 | 0,3 |



85069 0,5 ltr.



85070 0,9 ltr.



85061 1,7 ltr.

Schale „NERO“

bowl
cuenco
bol



| | ∅ cm | ↑ cm | ltr. |
|-------|------|------|------|
| 85069 | 16 | 6,5 | 0,5 |
| 85070 | 19 | 8,0 | 0,9 |
| 85061 | 24 | 9,0 | 1,7 |

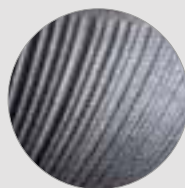

85060 0,8 ltr.



85062 2,2 ltr.

Schale „NERO“

bowl
cuenco
bol



| | ∅ cm | ↑ cm | ltr. |
|-------|------|------|------|
| 85060 | 22,5 | 4,5 | 0,8 |
| 85062 | 30,0 | 7,0 | 2,2 |



85071 1,5 ltr.



85072 3,5 ltr.

Schale „NERO“

bowl, square
cuenco, cuadrado
bol creux carré



| | cm | ↑ cm | ltr. |
|-------|-------------|------|------|
| 85071 | 19,5 x 19,5 | 8 | 1,5 |
| 85072 | 25,0 x 25,0 | 11 | 3,5 |

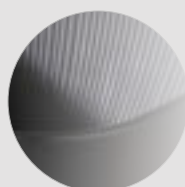
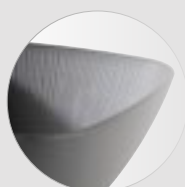

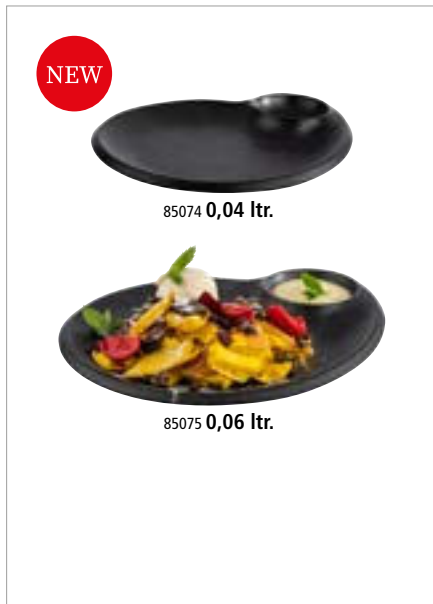

NEW



85074 **0,04 ltr.**



85075 **0,06 ltr.**

Teller „NERO“

plate
plato
assiette

mit integriertem Dipschälchen / Vertiefung
with integrated dip bowl / with notch
con cuenco para dip integrado / con ranura
avec ramequin intégré / avec encoche



| | cm | ↑ cm | ltr. |
|-------|---------|------|------|
| 85074 | 24 x 20 | 2,5 | 0,04 |
| 85075 | 30 x 25 | 2,5 | 0,06 |

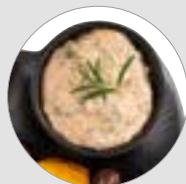

NEW



Tablett „NERO“

tray
bandeja
plateau

mit 2 integrierten Dipschälchen / Vertiefungen
with 2 integrated dip bowls / with 2 notches
con 2 cuencos para dip integrados / con 2 ranuras
avec 2 ramequins intégrés / avec 2 encoches



| | cm | ↑ cm | ltr. |
|-------|---------|------|----------|
| 85097 | 41 x 15 | 2,5 | 2 x 0,03 |

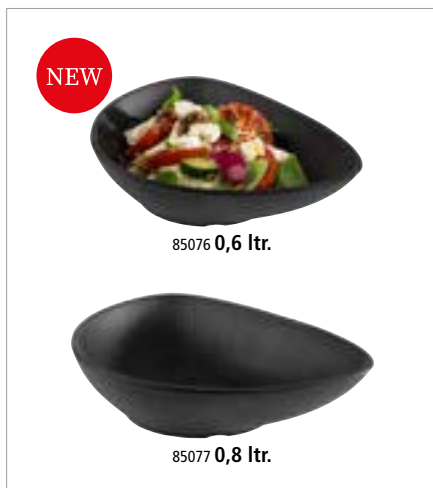

NEW



85076 **0,6 ltr.**



85077 **0,8 ltr.**

Schale „NERO“

bowl
cuenco
bol

| | cm | ↑ cm | ltr. |
|-------|---------|------|------|
| 85076 | 23 x 18 | 5 | 0,6 |
| 85077 | 28 x 22 | 7 | 0,8 |

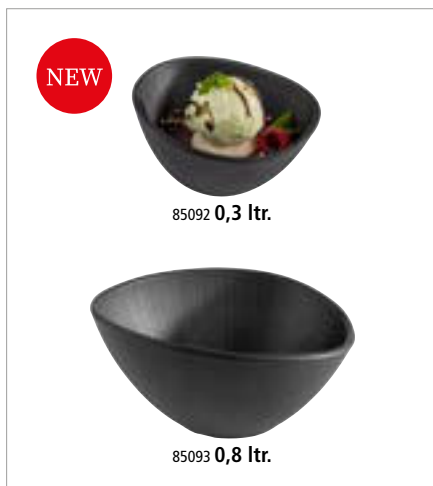
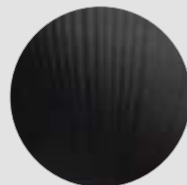

NEW



85092 **0,3 ltr.**



85093 **0,8 ltr.**

Schale „NERO“

bowl
cuenco
bol

| | cm | ↑ cm | ltr. |
|-------|-------------|------|------|
| 85092 | 14,5 x 12,5 | 8 | 0,3 |
| 85093 | 19,0 x 16,5 | 9 | 0,5 |

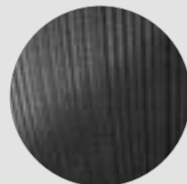



NEW

CANCUN



NEW

Tablett/Sushiboard „CANCUN“

tray
bandeja
plateauMAX
70°C

| | cm | ↑ cm |
|-------|-------------|------|
| 85200 | 23,5 x 13,5 | 1,5 |



NEW

Teller „CANCUN“

plate
plato
plateauMAX
70°C

| | cm | ↑ cm |
|-------|-----------|------|
| 85201 | 28 x 13,5 | 4,0 |



NEW

Schale „CANCUN“

bowl
cuenco
bolMAX
70°C

| | Ø cm | ↑ cm | ltr. |
|-------|------|------|------|
| 85205 | 15,0 | 7,0 | 0,5 |
| 85206 | 18,5 | 8,0 | 1,0 |
| 85207 | 20,5 | 6,5 | 1,0 |
| 85208 | 24,0 | 9,0 | 1,8 |

85205 0,5 ltr.

85207 1,0 ltr.

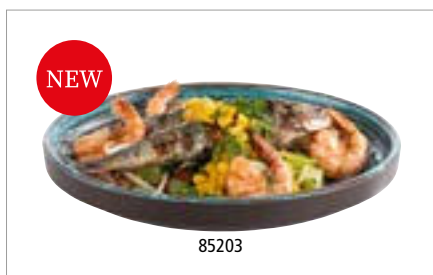

NEW

Teller „CANCUN“

plate
plato
plateauMAX
70°C

| | Ø cm | ↑ cm |
|-------|------|------|
| 85202 | 18,0 | 3,0 |
| 85203 | 23,0 | 3,5 |

85203



NEW

Teller „CANCUN“

plate
plato
plateauMAX
70°C

| | Ø cm | ↑ cm |
|-------|------|------|
| 85204 | 25,5 | 4,5 |



LOOPS

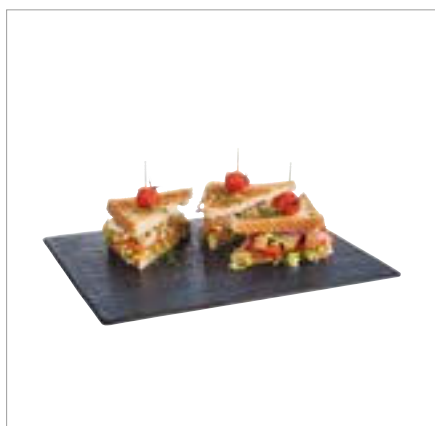

GN Tablett „LOOPS“

GN tray
GN bandeja
GN plateau



| | cm | ↑ cm | GN |
|-------|-------------|------|-----|
| 85021 | 32,5 x 26,5 | 1,5 | 1/2 |

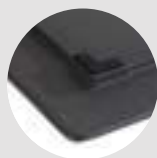

mit Antirutschfüßchen
with non-slip feet



Tablett/Sushiboard „LOOPS“

tray
bandeja
plateau



| | cm | ↑ cm |
|-------|-------------|------|
| 85025 | 23,5 x 13,5 | 1,5 |



Teller „LOOPS“

plate
plato
assiette



| | Ø cm | ↑ cm |
|-------|------|------|
| 85027 | 22 | 2 |
| 85028 | 27 | 2 |

85027



Teller „LOOPS“

plate
plato
plateau



| | Ø cm | ↑ cm |
|-------|-----------|------|
| 85024 | 34 x 15,5 | 4 |



Schale „LOOPS“

bowl
cuenco
bol



| | Ø cm | ↑ cm | ltr. |
|-------|------|------|------|
| 85026 | 18 | 3 | 0,25 |



Schale „LOOPS“

bowl
cuenco
bol



| | Ø cm | ↑ cm | ltr. |
|-------|------|------|------|
| 85029 | 20,5 | 6,5 | 1,0 |
| 85030 | 31,0 | 8,0 | 2,0 |



Schale „LOOPS“

bowl
cuenco
bol



| | Ø cm | ↑ cm | ltr. |
|-------|------|------|------|
| 85036 | 15,0 | 7,0 | 0,5 |
| 85037 | 18,5 | 8,0 | 1,0 |
| 85038 | 24,0 | 9,0 | 1,8 |



Teller „LOOPS“

plate
plato
plateau



| | cm | ↑ cm |
|-------|-----------|------|
| 85055 | 28 x 13,5 | 4,0 |



Teller „LOOPS“

plate
plato
plateau



| | Ø cm | ↑ cm |
|-------|------|------|
| 85056 | 23 | 3,5 |



Teller „LOOPS“

plate
plato
plateau



| | Ø cm | ↑ cm |
|-------|------|------|
| 85057 | 25,5 | 4,5 |

MOON



6 tlg.
6 pcs.



85080



85081

Servierset „MOON“, 6-teilig
 serving set, 6 pcs.
 set para servir, set de 6
 set de service, set de 6

6-teiliges Set: 3 Schalen + 3 Holzlöffel (Nanmu)

6 pcs.: 3 bowls + 3 wooden spoons (Nanmu)

set de 6: 3 cuencos + 3 cucharas de madera (Nanmu)

set de 6: 3 bols + 3 cuillères en bois (Nanmu)



| | Ø cm | ↑ cm | ltr. | Farbe / Colour |
|-------|------|------|------|----------------|
| 85080 | 8 | 7,5 | 0,05 | |
| 85081 | 8 | 7,5 | 0,05 | |



85080



85080

84938

Tablett / tray



85081



2 tlg.
2 pcs.



85082



85083



85084

Servierset „MOON“, 2-teilig

serving set, 2 pcs.
set para servir, set de 2
set de service, set de 2

2-teiliges Set: 1 Schale + 1 klappbarer Deckel

2 pcs.: 1 bowl + 1 hinged cover

set de 2: 1 cuenco + 1 tapa con bisagra

set de 2: 1 bol + 1 couvercle avec charnières



| | Ø cm | ↑ cm | ltr. | Farbe / Colour |
|-------|------|------|------|----------------|
| 85082 | 19 | 17,5 | 0,8 | |
| 85083 | 19 | 17,5 | 0,8 | |



85083



85082

klappbarer Deckel
hinged cover

Präsentationsmöglichkeit
presentation example

Klappdeckel „Moon“ mit Silikondichtung / hinged cover with silicone seal / tapa con bisagra y junta de silicona / couvercle avec charnières et joint en silicone

| | Ø cm | ↑ cm | fits to |
|-------|------|------|--------------|
| 85084 | 16 | 1,5 | 85082, 85083 |



85083

85082



85083



85082



85081

85080

84938

Tablett / tray

EMMA



85113

85116

85105

85104

85120

85101



85101 0,06 ltr



85104 0,50 ltr



85111 2,3 ltr

Schale „EMMA“ bowl cuenco bol



| | Ø cm | ↑ cm | ltr. | Farbe / Colour |
|-------|------|------|------|----------------|
| 85100 | 7,5 | 3,5 | 0,06 | ■ |
| 85101 | 7,5 | 3,5 | 0,06 | ■ |
| 85103 | 7,5 | 3,5 | 0,06 | ■ |
| 85104 | 14 | 6,5 | 0,5 | ■ |
| 85105 | 14 | 6,5 | 0,5 | ■ |
| 85107 | 14 | 6,5 | 0,5 | ■ |
| 85108 | 23 | 10,5 | 2,3 | ■ |
| 85109 | 23 | 10,5 | 2,3 | ■ |
| 85111 | 23 | 10,5 | 2,3 | ■ |

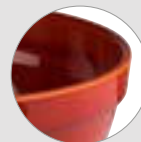
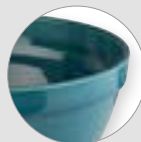



GN Tablett „EMMA“

GN tray
GN bandeja
GN plateau



| | cm | ↑ cm | GN | Farbe / Colour |
|-------|-------------|------|-----|----------------|
| 85120 | 26,5 x 16,2 | 3 | 1/4 | ■ |
| 85121 | 26,5 x 16,2 | 3 | 1/4 | ■ |
| 85123 | 26,5 x 16,2 | 3 | 1/4 | ■ |
| 85124 | 32,5 x 26,5 | 3 | 1/2 | ■ |
| 85125 | 32,5 x 26,5 | 3 | 1/2 | ■ |
| 85127 | 32,5 x 26,5 | 3 | 1/2 | ■ |

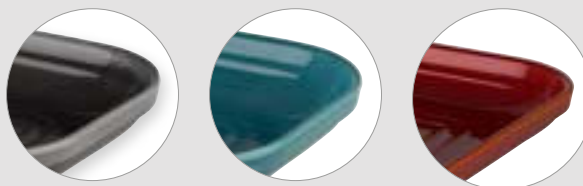

GN Schale „EMMA“

GN bowl
GN cuenco
GN bol



| | cm | ↑ cm | ltr. | GN | Farbe / Colour |
|-------|-------------|------|------|-----|----------------|
| 85128 | 26,5 x 16,2 | 7,5 | 1,5 | 1/4 | ■ |
| 85129 | 26,5 x 16,2 | 7,5 | 1,5 | 1/4 | ■ |
| 85131 | 26,5 x 16,2 | 7,5 | 1,5 | 1/4 | ■ |
| 85132 | 32,5 x 26,5 | 7,5 | 3,5 | 1/2 | ■ |
| 85133 | 32,5 x 26,5 | 7,5 | 3,5 | 1/2 | ■ |
| 85135 | 32,5 x 26,5 | 7,5 | 3,5 | 1/2 | ■ |

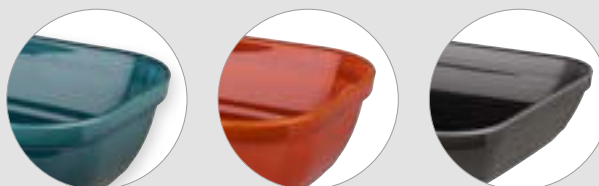

Cooling bowl



APS+



GN 1/4 Schale „APS+“

GN 1/4 bowl
GN 1/4 cuenco
GN 1/4 bol



| | cm | ↑ cm | GN | ltr. | Farbe / Colour |
|-------|-------------|------|-----|------|----------------|
| 15116 | 26,5 x 16,2 | 7 | 1/4 | 1,5 | White |

passender Deckel / suitable lid / tapa adecuada / couvercle approprié

| | cm | ↑ cm | GN | | |
|-------|-------------|------|-----|--|--|
| 15348 | 26,5 x 16,2 | 1,5 | 1/4 | | |



Schale, quadratisch „APS+“

bowl, square
cuenco cuadrado
bol carré



| | cm | ↑ cm | ltr. | Farbe / Colour |
|-------|-------------|------|------|----------------|
| 15110 | 6,5 x 6,5 | 6 | 0,15 | White |
| 15111 | 9,0 x 9,0 | 4 | 0,15 | White |
| 15112 | 13,0 x 13,0 | 7 | 0,60 | White |



Schale, quadratisch „APS+“

bowl, square
cuenco cuadrado
bol carré



| | cm | ↑ cm | ltr. | Farbe / Colour |
|-------|-------------|------|------|----------------|
| 15113 | 20,0 x 20,0 | 7 | 1,5 | White |

| | cm | ↑ cm | ltr. | Farbe / Colour |
|-------|-------------|------|------|----------------|
| 15215 | 13,0 x 13,0 | 7 | 0,6 | Black |
| 15216 | 20,0 x 20,0 | 7 | 1,5 | Black |
| 15217 | 24,0 x 24,0 | 9 | 3,5 | Black |



Schale, rund „APS+“

bowl, round
cuenco, redondo
bol rond



| | cm | ↑ cm | ltr. | Farbe / Colour |
|-------|-----|------|------|----------------|
| 15100 | 6,5 | 6 | 0,15 | White |
| 15101 | 9,0 | 4 | 0,15 | White |

| | Ø cm | ↑ cm | ltr. | Farbe / Colour |
|-------|------|------|------|----------------|
| 15200 | 6,5 | 6 | 0,15 | White |
| 15201 | 9,0 | 4 | 0,15 | White |





GN Tablett „ASIA PLUS“

GN tray
GN bandeja
GN plateau



| | cm | ↑ cm | GN | Farbe / Colour |
|-------|-------------|------|-----|----------------|
| 15449 | 53,0 x 32,5 | 3 | 1/1 | White |
| 15450 | 32,5 x 26,5 | 3 | 1/2 | White |
| 15451 | 32,5 x 17,6 | 3 | 1/3 | White |
| 15452 | 26,5 x 16,2 | 3 | 1/4 | White |
| 15453 | 35,4 x 32,5 | 3 | 2/3 | White |
| 15454 | 53,0 x 16,2 | 3 | 2/4 | White |
| 15455 | 53,0 x 32,5 | 3 | 1/1 | Red |
| 15456 | 32,5 x 26,5 | 3 | 1/2 | Red |
| 15457 | 32,5 x 17,6 | 3 | 1/3 | Red |
| 15458 | 26,5 x 16,2 | 3 | 1/4 | Red |
| 15460 | 53,0 x 16,2 | 3 | 2/4 | Red |



Schale „ASIA PLUS“

bowl
cuenco
bol



| | Ø cm | ↑ cm | ltr. | Farbe / Colour |
|-------|------|------|------|----------------|
| 15400 | 7,5 | 3,5 | 0,06 | White |
| 15401 | 9,5 | 4,5 | 0,13 | White |
| 15402 | 13,0 | 5,5 | 0,35 | White |
| 15403 | 16,0 | 7,0 | 0,60 | White |
| 15404 | 20,0 | 8,0 | 1,10 | White |
| 15416 | 7,5 | 3,5 | 0,06 | Red |
| 15417 | 9,5 | 4,5 | 0,13 | Red |
| 15418 | 13,0 | 5,5 | 0,35 | Red |
| 15419 | 16,0 | 7,0 | 0,60 | Red |
| 15420 | 20,0 | 8,0 | 1,10 | Red |
| 15421 | 24,0 | 9,5 | 2,20 | Red |



Teller „ASIA PLUS“

plate
plato
assiette



| | Ø cm | ↑ cm | Farbe / Colour |
|-------|------|------|----------------|
| 15424 | 11,0 | 2 | White |
| 15425 | 16,0 | 2 | White |



Bento Box „ASIA PLUS“



| | Ø cm | ↑ cm | ltr. | Farbe / Colour |
|-------|------|------|------|----------------|
| 15461 | 7,5 | 3,0 | 0,04 | White |
| 15462 | 7,5 | 6,5 | 0,13 | White |
| 15467 | 7,5 | 3,0 | 0,04 | Red |



Bento Box „ASIA PLUS“



| | cm | ↑ cm | ltr. | Farbe / Colour |
|-------|------------|------|------|----------------|
| 15473 | 7,5 x 7,5 | 3,0 | 0,05 | |
| 15474 | 7,5 x 7,5 | 6,5 | 0,16 | |
| 15485 | 7,5 x 7,5 | 3,0 | 0,05 | |
| 15486 | 7,5 x 7,5 | 6,5 | 0,16 | |
| 15475 | 15,5 x 7,5 | 3,0 | 0,10 | |
| 15477 | 15,5 x 9,5 | 3,0 | 0,15 | |



GN Buffetständer „ASIA PLUS“

GN buffet stand
GN soporte para buffet
GN présentoir buffet



Auf der kurzen und der langen Seite aufstellbar!

Can stay on the short or long side!
Se puede colocar por la parte corta o larga!
Se peut installer sur le côté court ou long!

| | cm | GN | Farbe / Colour |
|-------|---------------------------|-----------|----------------|
| 15501 | 53,0 x 32,5 / 53,0 x 16,2 | 1/1 / 2/4 | |
| 15502 | 32,5 x 26,5 / 26,5 x 16,2 | 1/2 / 1/4 | |
| 15503 | 32,5 x 17,5 / 35,4 x 32,5 | 1/3 / 2/3 | |
| 15504 | 53,0 x 32,5 / 53,0 x 16,2 | 1/1 / 2/4 | |
| 15505 | 32,5 x 26,5 / 26,5 x 16,2 | 1/2 / 1/4 | |
| 15506 | 32,5 x 17,5 / 35,4 x 32,5 | 1/3 / 2/3 | |

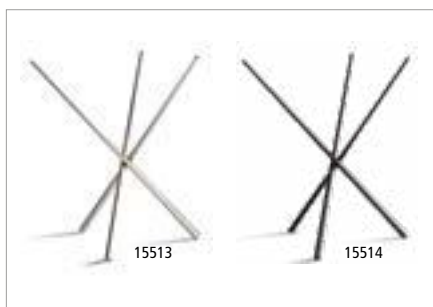

Buffetständer „ASIA PLUS“

buffet stand
soporte para buffet
présentoir buffet



| | Ø cm | ↑ cm | Farbe / Colour |
|-------|-------------|------|-----------------|
| 15513 | 20,5 / 16,5 | 20 | stainless steel |
| 15514 | 20,5 / 16,5 | 20 | |



Korb / Ständer „APS PLUS“

basket / riser
cesta / soporte
corbeille / support



| | Ø cm | ↑ cm | Farbe / Colour |
|-------|----------|------|-----------------|
| 15320 | 10,5 / 8 | 8 | polished chrome |
| 15324 | 10,5 / 8 | 8 | brushed gold |
| 15322 | 10,5 / 8 | 8 | brushed copper |



BLUE OCEAN



Da geht die Sonne auf!

Maritime Aquatöne, Farbverläufe und klassisches Blau-Weiß erinnert an eine griechische Taverne in der Ägäis.

The sun is rising!

Maritime aqua tones, gradients and classic blue and white reminiscent of a Greek tavern in the Aegean Sea.

¡Está saliendo el sol!

Los tonos marinos, los degradados de color, el clásico azul y blanco recuerdan a una taberna griega en el mar Egeo.

Le soleil se lève!

Les tons maritimes, les dégradés de couleurs, le bleu et le blanc classiques, tout rappellent une taverne grecque de la mer Égée.

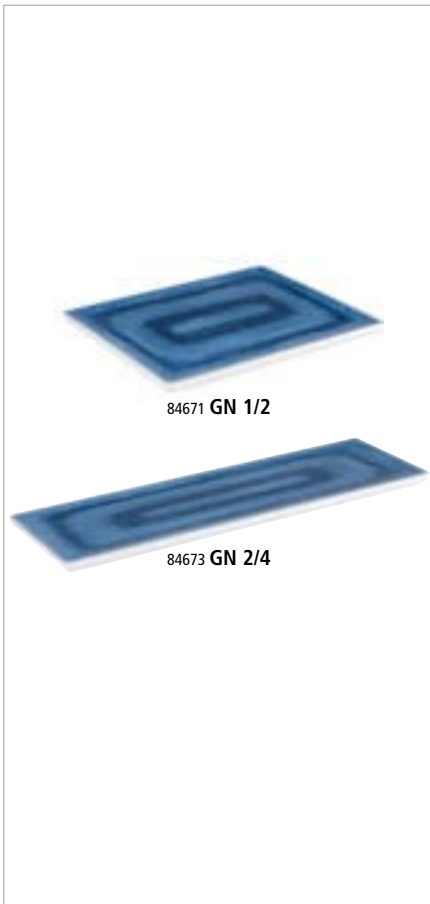

GN Tablett „BLUE OCEAN“

GN tray
GN bandeja
GN plateau



| | cm | ↑ cm | GN |
|-------|-------------|------|-----|
| 84671 | 32,5 x 26,5 | 2 | 1/2 |
| 84672 | 32,5 x 17,6 | 2 | 1/3 |
| 84673 | 53,0 x 16,2 | 2 | 2/4 |

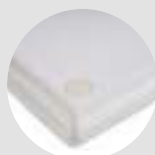

mit Antirutschfüßchen
with non-slip feet

BLUE OCEAN



Tablett „BLUE OCEAN“

tray
bandeja
plateau



| | cm | ↑ cm |
|-------|-----------|------|
| 84676 | 48 x 35,5 | 3 |



84677 0,6 ltr

84678 3,0 ltr

Schale „BLUE OCEAN“

bowl
cuenco
bol

| | Ø cm | ↑ cm | ltr. |
|-------|------|------|------|
| 84677 | 15 | 7,5 | 0,6 |
| 84678 | 30,5 | 9 | 3 |



84674

84675

Teller „BLUE OCEAN“

plate
plato
assiette



| | Ø cm | ↑ cm |
|-------|------|------|
| 84674 | 21,5 | 2 |
| 84675 | 26,5 | 2 |

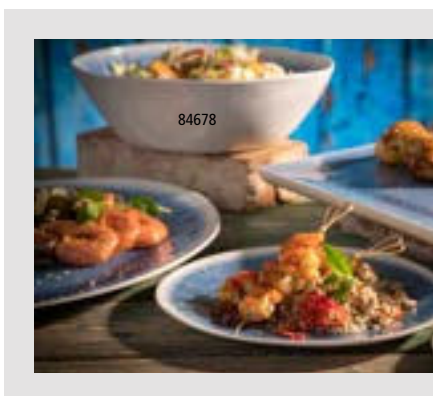

84678



84677



84678

ARABESQUE



Beim Anblick der mediterranen Melamin Serie ARABESQUE bekommt man direkt Lust auf eine Tapas-Party. Mit seinem spanischen Charme und den wundervoll ausgearbeiteten Details holen Sie sich ein Stück Spanien auf Ihr Buffet.

When looking at the Mediterranean melamine series ARABESQUE, the longing for a tapas party resurfaces. With its Spanish charm and the beautifully crafted details, you get a slice of Spain on your buffet.

Al ver la serie mediterránea de melamina ARABESQUE, se obtiene un dicho antojo por una fiesta de tapas. Con su encanto español y los detalles bellamente elaborados, obtendrá un trozo de España en su buffet.

En regardant la série de mélamine méditerranéenne ARABESQUE, vous obtenez envie de préparer une fête de tapas. Avec son charme espagnol et les détails joliment ouverts, vous aurez une tranche d'Espagne sur votre buffet.



GN Tablett „ARABESQUE“

GN tray
GN bandeja
GN plateau



| | cm | ↑ cm | GN |
|-------|-------------|------|-----|
| 84680 | 53,0 x 32,5 | 2 | 1/1 |
| 84681 | 32,5 x 26,5 | 2 | 1/2 |
| 84682 | 32,5 x 17,6 | 2 | 1/3 |
| 84683 | 53,0 x 16,2 | 2 | 2/4 |

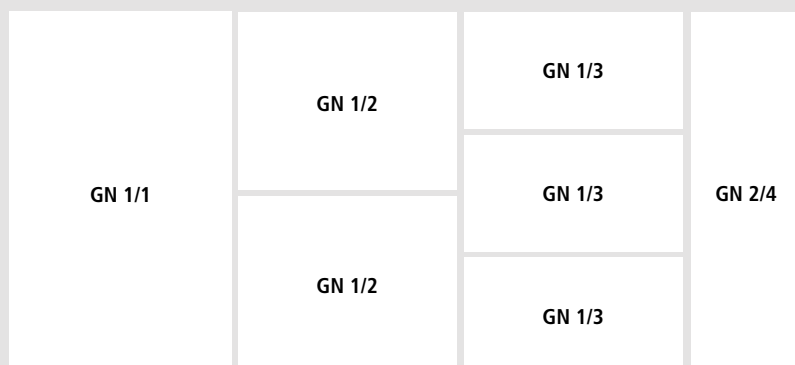

ARABESQUE

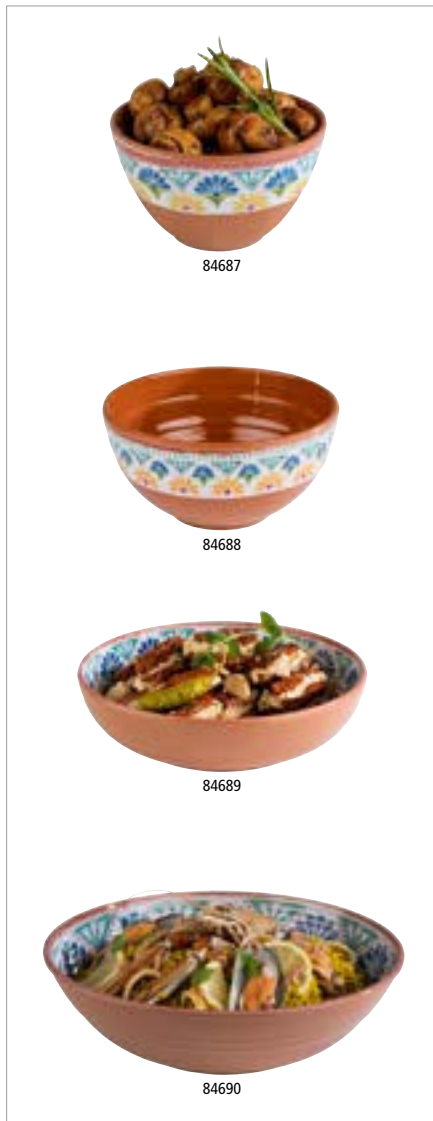

84687

84688

84689

84690

Schale „ARABESQUE“

bowl
cuenco
bol



MAX
70°C



| | ∅ cm | ↑ cm | litr. |
|-------|------|------|-------|
| 84687 | 10,0 | 6,0 | 0,2 |
| 84688 | 15,5 | 8,0 | 0,8 |

| | ∅ cm | ↑ cm | litr. |
|-------|------|------|-------|
| 84689 | 20,5 | 5,5 | 1,1 |
| 84690 | 31,0 | 9,0 | 3,0 |



Teller „ARABESQUE“

plate
plato
assiette



MAX
70°C



| | cm | ↑ cm |
|-------|-----------|------|
| 84686 | 38 x 15,5 | 2 |



84684

84685

Teller „ARABESQUE“

plate
plato
assiette



MAX
70°C



| | ∅ cm | ↑ cm |
|-------|------|------|
| 84684 | 21,5 | 2 |
| 84685 | 26,5 | 2 |

BAMBOO



84816

Schale „BAMBOO“
bowl
cuenco
bol



| | cm | ↑ cm | ltr. |
|-------|-------------|------|------|
| 84815 | 10,5 x 10,0 | 3,0 | 0,03 |
| 84816 | 17,5 x 15,5 | 5,5 | 0,2 |



Schale „BAMBOO“
bowl
cuenco
bol



| | Ø cm | ↑ cm | ltr. |
|-------|------|------|------|
| 84819 | 30,5 | 8,5 | 2 |



84803

84804

84807

Tablett „BAMBOO“
tray
bandeja
plateau



| | cm | ↑ cm |
|-------|-------------|------|
| 84803 | 10,0 x 10,0 | 2,0 |
| 84804 | 14,5 x 14,5 | 2,5 |
| 84805 | 31,0 x 10,5 | 2,0 |
| 84806 | 21,0 x 13,0 | 3,0 |
| 84807 | 24,5 x 15,5 | 3,0 |
| 84808 | 34,5 x 21,5 | 3,0 |

STONE ART



84511

Teller „STONE ART“
plate
plato
assiette



| | Ø cm | ↑ cm |
|-------|------|------|
| 84510 | 19 | 2 |
| 84511 | 25 | 2 |
| 84512 | 30 | 2 |



84509

Teller „STONE ART“
plate
plato
assiette



| | Ø cm | ↑ cm | litr. |
|-------|------|------|-------|
| 84509 | 15,5 | 2,5 | 0,15 |
| 84514 | 20,0 | 4,5 | 0,60 |



Teller „STONE ART“
plate
plato
assiette



| | Ø cm | ↑ cm |
|-------|------|------|
| 84515 | 24,5 | 3,5 |



Teller „STONE ART“
plate
plato
assiette



| | cm | ↑ cm |
|-------|-----------|------|
| 84517 | 33 x 32,5 | 3 |



Schale „STONE ART“

bowl
cuenco
bol



| | ∅ cm | ↑ cm | ltr. |
|-------|------|------|------|
| 84523 | 8 | 3 | 0,07 |



Schale „STONE ART“

bowl
cuenco
bol



| | ∅ cm | ↑ cm | ltr. |
|-------|------|------|------|
| 84524 | 12 | 6 | 0,3 |



Schale „STONE ART“

bowl
cuenco
bol



| | ∅ cm | ↑ cm | ltr. |
|-------|------|------|------|
| 84525 | 15 | 7,5 | 0,6 |



Schale „STONE ART“

bowl
cuenco
bol



| | cm | ↑ cm | ltr. |
|-------|---------|------|------|
| 84526 | 23 x 19 | 6,5 | 0,6 |



Schale „STONE ART“

bowl
cuenco
bol



| | cm | ↑ cm | ltr. |
|-------|-----------|------|------|
| 84528 | 28,5 x 21 | 7,5 | 1,2 |



84529

Schale „STONE ART“

bowl
cuenco
bol



| | cm | ↑ cm | ltr. |
|-------|---------|------|------|
| 84529 | 19 x 19 | 6,0 | 0,5 |
| 84530 | 24 x 24 | 6,5 | 1,1 |

STONE ART



GN Tablett „STONE ART“

GN tray
GN bandeja
GN plateau



| | cm | ↑ cm | GN |
|-------|-------------|------|-----|
| 84519 | 53,0 x 32,5 | 1,5 | 1/1 |
| 84520 | 32,5 x 26,5 | 1,5 | 1/2 |
| 84522 | 53,0 x 16,2 | 1,5 | 2/4 |
| 84521 | 32,5 x 17,6 | 1,5 | 1/3 |



mit Antirutschfüßchen
with non-slip feet



GN Abdeckhaube

GN cover
GN cubierta
GN cloche



passend für GN Tablett, glasklarer Kunststoff, nahezu unzerbrechlich

suitable for GN trays, clear plastic, nearly unbreakable

apto para bandejas GN, plástico transparente, muy resistente a la rotura

pour plateaux GN, plastique transparent, très résistant à la casse

| | cm | ↑ cm | mm | GN |
|-------|-------------|------|----|-----|
| 11043 | 32,5 x 17,6 | 10,5 | 3 | 1/3 |
| 11044 | 53,0 x 16,2 | 10,5 | 3 | 2/4 |

| | cm | ↑ cm | mm | GN |
|-------|-------------|------|----|-----|
| 11041 | 32,5 x 26,5 | 9,5 | 3 | 1/2 |
| 11042 | 53,0 x 32,5 | 9,5 | 3 | 1/1 |

AIKO



Schalen der Serie Aiko eignen sich perfekt zum Präsentieren von leckeren Saucen, Pasten oder frischem Sushi. Aber auch kleines Fingerfood kann hübsch präsentiert und angerichtet werden.

Bowls from the Aiko series are perfect for presenting delicious sauces, pastes or fresh sushi. Also small finger food can be presented and served in a pretty way.

Los cuencos de la serie Aiko son perfectos para presentar deliciosas salsas, pastas o sushi fresco. Pero también se pueden presentar y servir de forma atractiva pequeños aperitivos.

Les bols de la série Aiko sont parfaits pour présenter de délicieuses sauces, des pâtes ou des sushis frais. Mais les petits apéritifs peuvent également être présentés et servis de manière attrayante.



84329 0,07 ltr.



84331 0,2 ltr.

Schale „AIKO“

bowl
cuenco
bol

Steinoptik

appearance stoneware

su aspecto recuerda al gres

l'aspect de la mélamine rapelle le grès



| | Ø cm | ↑ cm | ltr. | Farbe / Colour |
|-------|------|------|------|----------------|
| 84329 | 8,0 | 4 | 0,07 | ■ |
| 84331 | 11,5 | 6 | 0,20 | ■ |



84335 0,6 ltr.



84337 1,2 ltr.

Schale „AIKO“

bowl
cuenco
bol

Steinoptik

appearance stoneware

su aspecto recuerda al gres

l'aspect de la mélamine rapelle le grès



| | Ø cm | ↑ cm | ltr. | Farbe / Colour |
|-------|------|------|------|----------------|
| 84335 | 16,0 | 7 | 0,6 | ■ |
| 84337 | 20,5 | 8 | 1,2 | ■ |

ELEMENT



Betonoberflächen auf dem Buffet für den Kontakt mit Lebensmitteln?
ELEMENT macht es möglich.
 Bestens geeignet im modernen und urbanen Ausstattungsumfeld.

Concrete surfaces on the buffet for food contact?
ELEMENT makes it possible.
 Ideally suited for modern and urban environments.

¿Superficies de hormigón en el buffet y tener contacto con alimentos?
ELEMENT lo hace posible.
 Ideal para ambientes modernos y urbanos.

Des surfaces en béton sur le buffet et destinées au contact alimentaire?
ELEMENT le rend possible.
 Idéal pour les environnements modernes et urbains.



Schale „ELEMENT“

bowl
 cuenco
 bol



| | cm | ↑ cm | ltr. |
|-------|-------------|------|------|
| 84825 | ∅ 8,0 | 2,0 | 0,01 |
| 84826 | 10,5 x 10,0 | 3,0 | 0,02 |
| 84820 | 9,0 x 7,0 | 3,0 | 0,03 |
| 84821 | 10,5 x 10,5 | 3,0 | 0,04 |
| 84827 | 17,5 x 15,5 | 5,5 | 0,18 |



Schale „ELEMENT“

bowl
 cuenco
 bol



| | ∅ cm | ↑ cm | ltr. |
|-------|------|------|------|
| 84828 | 16 | 7 | 0,5 |
| 84829 | 28 | 12 | 3,0 |



82831 3,0 ltr

Schale „ELEMENT“

bowl
cuenco
bol



| | cm | ↑ cm | ltr. |
|-------|---------|------|------|
| 84830 | 19 x 19 | 9 | 1,5 |
| 84831 | 25 x 25 | 12 | 3,8 |



Tablett „ELEMENT“

tray
bandeja
plateau



| | cm | ↑ cm |
|-------|-----------|------|
| 84824 | 31 x 10,5 | 1,5 |



GN Tablett „ELEMENT“

GN tray
GN bandeja
GN plateau



| | cm | ↑ cm | GN |
|-------|-------------|------|-----|
| 84400 | 53,0 x 32,5 | 3,5 | 1/1 |
| 84401 | 32,5 x 26,5 | 3,5 | 1/2 |
| 84402 | 32,5 x 17,5 | 3,5 | 1/3 |
| 84403 | 26,5 x 16,2 | 3,5 | 1/4 |
| 84404 | 53,0 x 16,2 | 3,5 | 2/4 |



Schale „ELEMENT LOOK“

bowl
cuenco
bol



| | Ø cm | ↑ cm | ltr. |
|-------|------|------------|------|
| 84835 | 21,5 | 5,5 / 9,5 | 0,7 |
| 84836 | 26,0 | 7,0 / 12,5 | 1,45 |
| 84837 | 30,0 | 8,5 / 14,5 | 2,3 |



mit Antirutschfüßchen
with non-slip feet



GN Tablett „ELEMENT“

GN tray
GN bandeja
GN plateau



| | cm | ↑ cm | GN | Farbe / colour |
|-------|-------------|------|-----|----------------|
| 84986 | 56,0 x 35,5 | 1,5 | 1/1 | ■ |
| 84988 | 35,5 x 29,0 | 1,5 | 1/2 | ■ |

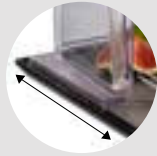

mit Antirutschrinne für Hauben
with non-slip groove for covers

passende Hauben / suitable covers / campanas adecuadas / cloches appropriées

| | cm | ↑ cm | GN |
|-------|-------------|------|-----|
| 11010 | 53,0 x 32,5 | 19 | 1/1 |
| 11027 | 53,0 x 32,5 | 9,5 | 1/1 |
| 11041 | 32,5 x 26,5 | 9,5 | 1/2 |
| 11021 | 33,0 x 28,0 | 17 | 1/2 |



GN Tablett „BUFFET PRO“

GN tray
GN bandeja
GN plateau

mit Mulde für Besteckablage
with tray for cutlery storage
con espacio reposa cubiertos
avec espace repose-ustensiles



| | cm | ↑ cm | GN | Farbe / colour |
|-------|-------------|------|-----|----------------|
| 85145 | 53,0 x 32,5 | 1,5 | 1/1 | ■ |
| 85146 | 32,5 x 26,5 | 1,5 | 1/2 | ■ |



mit Mulde für Vorlagegabel
with tray for cutlery storage



Präsentationsmöglichkeit
presentation example

TIMBER



Tablett „TIMBER“

tray
bandeja
plateau



cm ↑ cm

84256 70 x 26 3



Tablett „TIMBER“

tray
bandeja
plateau



cm ↑ cm

84269 65 x 26 3



Tablett „TIMBER“

tray
bandeja
plateau



Ø cm ↑ cm

84266 35 3



Tablett „TIMBER“

tray
bandeja
plateau



cm ↑ cm

84268 44 x 25 1,5

OAK



Tablett „OAK“

tray
bandeja
plateau



| | cm | ↑ cm | Griff / handle cm |
|-------|---------|------|-------------------|
| 84178 | 40 x 20 | 1,5 | 13 |
| 84179 | 48 x 20 | 1,5 | 13 |



Tablett „OAK“

tray
bandeja
plateau



| | Ø cm | ↑ cm | Griff / handle cm |
|-------|------|------|-------------------|
| 84177 | 30 | 1,5 | 12 |



Schale „OAK“

bowl
cuenco
bol



| | cm | ↑ cm |
|-------|------------|------|
| 84434 | 11,5 x 7,0 | 2,5 |

OAK LIGHT

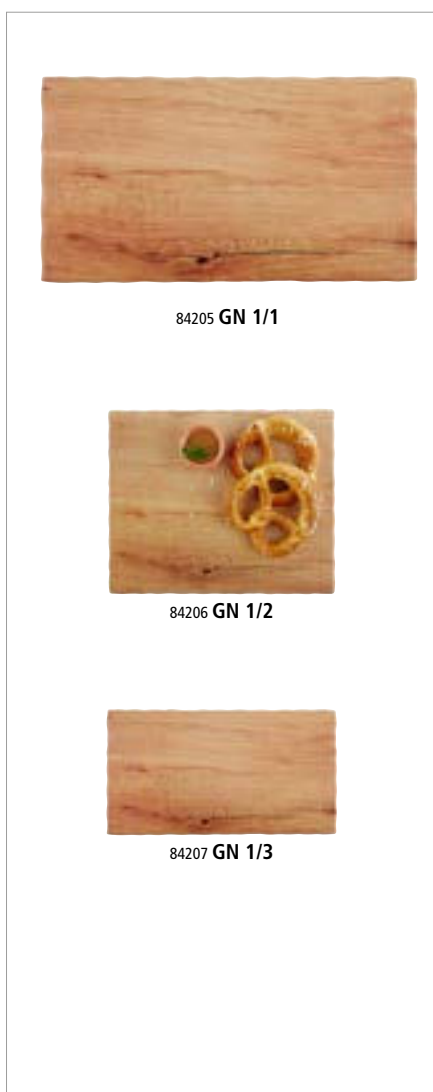

GN Tablett „OAK LIGHT“

GN tray
GN bandeja
GN plateau



| | cm | ↑ cm | GN |
|-------|-------------|------|-----|
| 84205 | 53,0 x 32,5 | 1,5 | 1/1 |
| 84206 | 32,5 x 26,5 | 1,5 | 1/2 |
| 84207 | 32,5 x 17,6 | 1,5 | 1/3 |
| 84208 | 26,5 x 16,2 | 1,5 | 1/4 |
| 84209 | 53,0 x 16,2 | 1,5 | 2/4 |



Tablett „OAK LIGHT“

tray
bandeja
plateau



| | cm | ↑ cm |
|-------|---------|------|
| 84265 | 65 x 26 | 3 |



GLAMOUR

84377

84381



Schale „GLAMOUR“

bowl
cuenco
bol



| | ∅ cm | ↑ cm | litr. |
|-------|------|------|-------|
| 84365 | 8 | 3 | 0,05 |



Schale „GLAMOUR“

bowl
cuenco
bol



| | ∅ cm | ↑ cm | litr. |
|-------|------|------|-------|
| 84366 | 12 | 5 | 0,25 |



84377

84378

Tablett „GLAMOUR“

tray
bandeja
plateau



| | cm | ↑ cm |
|-------|---------|------|
| 84377 | 22 x 12 | 3,0 |
| 84378 | 37 x 11 | 2,5 |

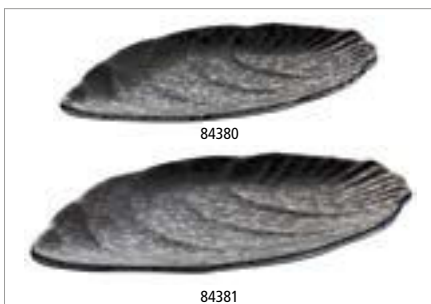

84380

84381

Tablett „GLAMOUR“

tray
bandeja
plateau



| | cm | ↑ cm |
|-------|-------------|------|
| 84380 | 25,0 x 15,5 | 1,5 |
| 84381 | 30,5 x 19,0 | 1,5 |



Tablett „GLAMOUR“

tray
bandeja
plateau



| | cm | ↑ cm |
|-------|---------|------|
| 84379 | 30 x 11 | 3 |

CROCKER



Servier- und Buffetartikel in Tonoptik, brauner Rand. Die Oberfläche ist innen und außen fein-matt, fühlt sich an wie Ton.

Serving and buffet items, an imitation of clay, with a brown border. The surface is inside and outside fine-matt. Feels like real clay.

Artículos de servicio y buffet, imitación barro y con borde marrón. La superficie de dentro y de fuera es de deslustre fino. Parece barro natural.

Pièces de service et pour le buffet imitation argile avec bord marron. La surface est à l'intérieur et à l'extérieur bien-matte.



Teller „CROCKER“

plate
plato
assiette



| | cm | ↑ cm | Farbe / Colour |
|-------|---------|------|----------------|
| 84567 | 14 x 13 | 2,5 | |
| 84568 | 14 x 13 | 2,5 | |



Teller „CROCKER“

plate
plato
assiette



| | Ø cm | ↑ cm | ltr. | Farbe / Colour |
|-------|------|------|------|----------------|
| 84575 | 20,5 | 3 | 0,50 | |
| 84576 | 20,5 | 3 | 0,50 | |

CROCKER



Schale „CROCKER“

bowl
cuenco
bol



| | Ø cm | ↑ cm | ltr. | Farbe / Colour |
|-------|------|------|------|----------------|
| 84573 | 16,5 | 4 | 0,50 | |
| 84574 | 16,5 | 4 | 0,50 | |



Schale „CROCKER“

bowl
cuenco
bol



| | Ø cm | ↑ cm | ltr. | Farbe / Colour |
|-------|------|------|------|----------------|
| 84569 | 12,5 | 6 | 0,37 | |
| 84570 | 12,5 | 6 | 0,37 | |
| 84571 | 16,0 | 7 | 0,70 | |
| 84572 | 16,0 | 7 | 0,70 | |
| 84577 | 21,0 | 8 | 1,45 | |
| 84578 | 21,0 | 8 | 1,45 | |



Blattschale „CROCKER“

leaf
fuente en forma de hoja
plateau feuille



| | cm | ↑ cm | ltr. | Farbe / Colour |
|-------|-----------|------|------|----------------|
| 84579 | 30,5 x 10 | 7,5 | 0,17 | |
| 84580 | 30,5 x 10 | 7,5 | 0,17 | |
| 84581 | 42 x 14 | 9,5 | 0,65 | |
| 84582 | 42 x 14 | 9,5 | 0,65 | |

FRIDA



FRIDA

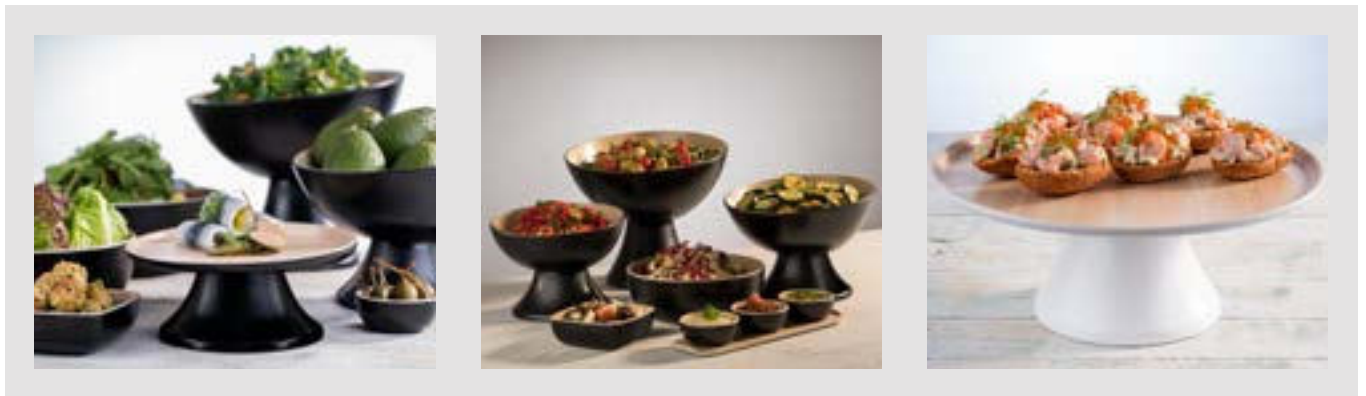



Schale „FRIDA LOCK“

bowl
cuenco
bol



Schalen lassen sich durch Drehmechanismus mit dem Ständer fest verbinden

bowls can be firmly connected to the stand by a turning mechanism

los cuencos se pueden conectar firmemente al soporte mediante un mecanismo giratorio

les bols peuvent être solidement reliés au présentoir au moyen d'un mécanisme rotatif

| | Ø cm | ↑ cm | ltr. | Farbe / Colour |
|-------|------|-------|------|----------------|
| 84920 | 21,5 | 7/8,5 | 1,0 | |
| 84921 | 21,5 | 7/8,5 | 1,0 | |
| 84922 | 25,0 | 8/11 | 1,6 | |
| 84923 | 25,0 | 8/11 | 1,6 | |
| 84924 | 28,5 | 10/14 | 2,6 | |
| 84925 | 28,5 | 10/14 | 2,6 | |

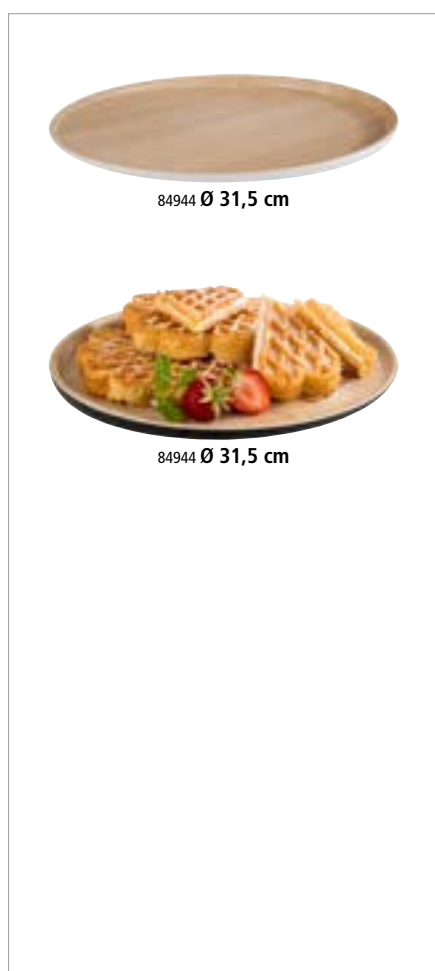

Tablett / Platte „FRIDA LOCK“

tray
bandeja
plateau



Tablets lassen sich durch Drehmechanismus mit dem Ständer fest verbinden

trays can be firmly connected to the stand by a turning mechanism

las bandejas se pueden conectar firmemente al soporte mediante un mecanismo giratorio

les plateaux peuvent être solidement reliés au présentoir au moyen d'un mécanisme rotatif

| | Ø cm | ↑ cm | Farbe / Colour |
|-------|------|---------|----------------|
| 84943 | 31,5 | 1,5/2,5 | |
| 84944 | 31,5 | 1,5/2,5 | |





Ständer „FRIDA LOCK“
stand
soporte
présentoir



| | Ø cm | ↑ cm | Farbe / Colour |
|-------|------|------|----------------|
| 84926 | 16,5 | 8 | White |
| 84927 | 16,5 | 8 | Black |



Ständer „FRIDA LOCK“
stand
soporte
présentoir



| | Ø cm | ↑ cm | Farbe / Colour |
|-------|------|------|----------------|
| 84928 | 16,5 | 12 | White |
| 84929 | 16,5 | 12 | Black |



Haube
cover
campana
cloche



| | Ø cm | ↑ cm | fits to |
|-------|------|------|----------------------------|
| 06519 | 21 | 17 | 84941, 84942 |
| 06520 | 30 | 22 | 00468, 00469, 84943, 84944 |
| 06521 | 36 | 27 | 84945, 84946 |
| | Ø cm | ↑ cm | fits to |
| 06525 | 30 | 40 | 00468, 00469, 84943, 84944 |



84605 0,25 ltr.



84608 0,45 ltr.



84609 1,2 ltr.

Schale „FRIDA“

bowl
cuenco
bol

| | Ø cm | ↑ cm | ltr. | Farbe / Colour |
|-------|------|------|------|----------------|
| 84605 | 12,5 | 4,5 | 0,25 | |
| 84606 | 12,5 | 4,5 | 0,25 | |
| 84607 | 15,0 | 5,5 | 0,44 | |
| 84608 | 15,0 | 5,5 | 0,44 | |
| 84609 | 20,0 | 7,5 | 1,20 | |
| 84610 | 20,0 | 7,5 | 1,20 | |

passende Deckel / suitable lid / tapa adecuada / couvercle approprié

| | Ø cm | ↑ cm | fits to |
|-------|------|------|--------------|
| 84963 | 13,0 | 2,5 | 84605, 84606 |
| 84964 | 16,0 | 2,5 | 84607, 84608 |



84612 2,2 ltr.



84613 3,4 ltr.

Schale „FRIDA“

bowl
cuenco
bol

| | Ø cm | ↑ cm | ltr. | Farbe / Colour |
|-------|------|------|------|----------------|
| 84611 | 22,0 | 10,5 | 2,2 | |
| 84612 | 22,0 | 10,5 | 2,2 | |
| 84613 | 26,5 | 10,5 | 3,4 | |
| 84614 | 26,5 | 10,5 | 3,4 | |

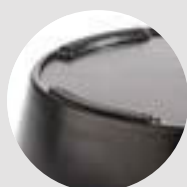
mit Antirutschfüßchen
with non-slip feet

84930 0,1 ltr.



84933 1,8 ltr.



84934 4,7 ltr.

Schale „FRIDA“

bowl
cuenco
bol

| | Ø cm | ↑ cm | ltr. | Farbe / Colour |
|-------|------|------|------|----------------|
| 84930 | 8,5 | 3,5 | 0,1 | |
| 84931 | 8,5 | 3,5 | 0,1 | |
| 84932 | 21,5 | 7,5 | 1,8 | |
| 84933 | 21,5 | 7,5 | 1,8 | |
| 84934 | 30,0 | 9,5 | 4,7 | |
| 84935 | 30,0 | 9,5 | 4,7 | |

passende Deckel / suitable lid / tapa adecuada / couvercle approprié

| | Ø cm | ↑ cm | fits to |
|-------|------|------|--------------|
| 84962 | 9,0 | 2,5 | 84930, 84931 |



84936 0,37 ltr.

84959 0,85 ltr.

84561 2,65 ltr.

Schale „FRIDA“

bowl
cuenco
bol



| | cm | ↑ cm | ltr. | Farbe / Colour |
|-------|-------------|------|------|----------------|
| 84936 | 12,5 x 12,5 | 4,5 | 0,37 | |
| 84937 | 12,5 x 12,5 | 4,5 | 0,37 | |
| 84558 | 16,5 x 16,5 | 5,5 | 0,85 | |
| 84559 | 16,5 x 16,5 | 5,5 | 0,85 | |
| 84561 | 25,0 x 25,0 | 7,5 | 2,65 | |
| 84562 | 25,0 x 25,0 | 7,5 | 2,65 | |

passende Deckel / suitable lid / tapa adecuada / couvercle approprié

| | cm | ↑ cm | fits to |
|-------|-------------|------|--------------|
| 84965 | 13,0 x 13,0 | 2,5 | 84936, 84937 |
| 84966 | 17,0 x 17,0 | 2,5 | 84558, 84559 |



84555 GN 1/9

84584 GN 1/6

84586 GN 1/4

84565 GN 2/4

84589 GN 1/2

GN Schale „FRIDA“

GN bowl
GN cuenco
GN bol



| | cm | ↑ cm | ltr. | GN | Farbe / Colour |
|-------|-------------|------|------|-----|----------------|
| 84555 | 17,6 x 10,8 | 5,5 | 1,5 | 1/9 | |
| 84556 | 17,6 x 10,8 | 5,5 | 1,5 | 1/9 | |
| 84583 | 17,6 x 16,2 | 7,5 | 1,0 | 1/6 | |
| 84584 | 17,6 x 16,2 | 7,5 | 1,0 | 1/6 | |
| 84586 | 26,5 x 16,2 | 7,5 | 1,8 | 1/4 | |
| 84587 | 26,5 x 16,2 | 7,5 | 1,8 | 1/4 | |
| 84564 | 53 x 16,2 | 7,5 | 3,65 | 2/4 | |
| 84565 | 53 x 16,2 | 7,5 | 3,65 | 2/4 | |
| 84589 | 32,5 x 26,5 | 7,5 | 4,0 | 1/2 | |
| 84590 | 32,5 x 26,5 | 7,5 | 4,0 | 1/2 | |

passende Deckel / suitable lid / tapa adecuada / couvercle approprié

| | cm | ↑ cm | fits to |
|-------|-------------|------|--------------|
| 84968 | 18,0 x 11,0 | 2,5 | 84555, 84556 |
| 84967 | 18,0 x 16,5 | 2,5 | 84583, 84584 |





Schale „FRIDA“

bowl
cuenco
bol



| | cm | ↑ cm | ltr. | Farbe / Colour |
|-------|---------|------|------|----------------|
| 84592 | 25 x 25 | 12 | 3,5 | |
| 84593 | 25 x 25 | 12 | 3,5 | |

Deckel „PURE“ mit Löffelaussparung
cover with notched for spoons
tapa con espacio para la cuchara
couverture avec encoche pour la louche



| | cm | ↑ cm | fits to |
|-------|---------|------|----------------------------|
| 83601 | 25 x 25 | 1,5 | 84561, 84562, 84592, 84593 |



mit Deckel stapelbar
stackable with cover



Schale „FRIDA“

bowl
cuenco
bol



| | cm | ↑ cm | ltr. | Farbe / Colour |
|-------|-----------|------|------|----------------|
| 84948 | 33,5 x 21 | 4 | 1,2 | |



als Schütte geeignet
suitable as a chute



GN Tablett „FRIDA“

GN tray
GN bandeja
GN plateau



| | cm | ↑ cm | GN | Farbe / Colour |
|-------|-------------|------|-----|----------------|
| 84985 | 56,0 x 35,5 | 1,5 | 1/1 | |
| 84987 | 35,5 x 29,0 | 1,5 | 1/2 | |



Präsentationsmöglichkeit
presentation example

passende Hauben / suitable covers / campanas adecuadas / cloches appropriées

| | cm | ↑ cm | GN |
|-------|-------------|------|-----|
| 11010 | 53,0 x 32,5 | 19,0 | 1/1 |
| 11042 | 53,0 x 32,5 | 9,5 | 1/1 |
| 11021 | 33,0 x 28,0 | 17,0 | 1/2 |

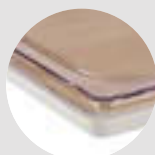

mit Antirutschrinne für Hauben
with non-slip groove for covers

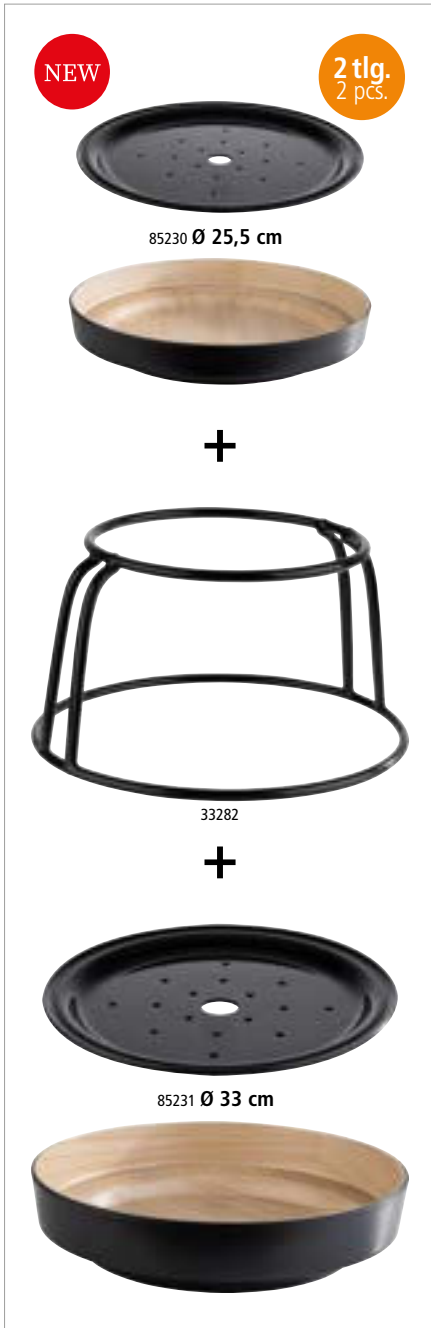

Schale, 2-teilig „FRIDA“

bowl, 2 pcs.
cuenca, set de 2
bol, set de 2

inklusive Abtropfeinsatz
including drip tray
con bandeja recoge gotas
avec égouttoir



| | Ø cm | ↑ cm | Farbe / Colour |
|-------|------|------|----------------|
| 85230 | 25,5 | 6 | ■ ■ |
| 85231 | 33,0 | 6 | ■ ■ |

Buffetständer

buffet stand
soporte para buffet
présentoir buffet



Metall, mit schwarzer Antirutschbeschichtung, für Schalen Nr. 85230, 85231
metal, with black anti-slip coating, for bowls no. 85230, 85231
metal, con revestimiento antideslizante negro, para cuencos 85230, 85231
métal, avec revêtement antidérapant noir, pour bols 85230, 85231

| | Ø cm | ↑ cm | Farbe / Colour |
|-------|-----------|------|----------------|
| 33282 | 23 / 30,5 | 17 | ■ |



Präsentationsmöglichkeit
presentation example



inklusive Abtropfeinsatz
including drip tray



3-stufige Etagère „FRIDA“

3-tier tray
bandeja con 3 alturas
étagère carré 3 hauteurs

1 Gestell aus Edelstahl, schwarz, 3 Schalen aus Melamin: Ø 20 / 25 / 32 cm
1 stainless steel frame, black, 3 melamine bowls: Ø 20 / 25 / 32 cm
1 soporte de acero inoxidable, negro, 3 cuencos de melamina: Ø 20 / 25 / 32 cm
1 support en acier inox, noir, 3 bols en mélamine: Ø 20 / 25 / 32 cm



| | Ø cm | ↑ cm | Farbe / Colour |
|-------|--------------|------|----------------|
| 85211 | 20 / 25 / 32 | 43 | ■ ■ ■ |

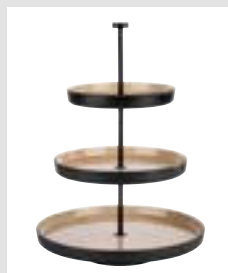

SLATE



Die schwarzen Melaminplatten überzeugen mit ihrem edlen und schlichten Schieferlook und einer rauhen Oberfläche.

The black melamine trays convince with their noble and simple slate look and a rough surface.

Las bandejas de melamina negras convencer por su aspecto de pizarra elegante y discreto y una superficie áspera.

Les plateaux en mélamine noirs convainquent grâce au aspect de l'ardoise élégant et discret et une surface rugueuse.



GN Tablett „SLATE“

GN tray
GN bandeja
GN plateau



| | cm | ↑ cm | GN |
|-------|-------------|------|-----|
| 83955 | 53,0 x 32,5 | 1 | 1/1 |
| 83956 | 32,5 x 26,5 | 1 | 1/2 |
| 83957 | 32,5 x 17,6 | 1 | 1/3 |
| 83958 | 26,5 x 16,2 | 1 | 1/4 |
| 83971 | 53,0 x 16,2 | 1 | 2/4 |



GN Tablett „SLATE“

GN tray
GN bandeja
GN plateau

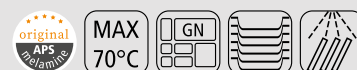

massive Metallgriffe verchromt inkl. fest verschraubten 4 cm Distanzstücken
chrome plated handles, incl. mounted 4 cm distance pillars
asas cromadas, incluye distanciadores de 4 cm firmemente montados
poignées chromées, y compris piliers de distance montées de 4 cm

| | cm | ↑ cm | GN |
|-------|-----------|------|-----|
| 83980 | 53 x 32,5 | 6 | 1/1 |

SLATE



GN Tablett „SLATE“

GN tray
GN bandeja
GN plateau



| | cm | ↑ cm | GN |
|-------|-----------|------|-----|
| 83981 | 53 x 32,5 | 1,5 | 1/1 |



Schieferoptik
slate look



83994

Tablett „SLATE“

tray
bandeja
plateau



| | Ø cm | ↑ cm |
|-------|------|------|
| 83992 | 30 | 1 |
| 83994 | 40 | 1 |



NEW

11056

85099

30336

Tablett „SLATE“

tray
bandeja
plateau

passend zu Etagère 30336

suitable for 2-tier tray 30336

adecuado para soporte 2 alturas 30336

adapté à étagère 2 niveaux



| | cm | ↑ cm |
|-------|-------------|------|
| 85099 | 28,0 x 15,5 | 1,0 |



Haube / cover / campana / cloche

| | cm | ↑ cm |
|-------|-------------|------|
| 11056 | 26,0 x 12,0 | 10,0 |



84245

83600

83601

Schale „SLATE“

bowl
cuenco
bol



| | cm | ↑ cm | ltr. |
|-------|---------|------|------|
| 84244 | 19 x 19 | 9 | 1,5 |
| 84245 | 25 x 25 | 12 | 3,8 |

Deckel „PURE“ mit Löffelaussparung

cover with notched for spoons

tapa con espacio para la cuchara

couvercle avec encoche pour la louche

| | cm | ↑ cm | fits to |
|-------|---------|------|---------|
| 83600 | 19 x 19 | 1,5 | 84244 |
| 83601 | 25 x 25 | 1,5 | 84245 |



SLATE ROCK

84258

84259

84257



Tablett „SLATE-ROCK“

tray
bandeja
plateau



Die schwarzen Melaminplatten überzeugen mit ihrem Schieferlook

The black melamine trays convince with their slate look

Las bandejas de melamina negras convencen por su aspecto de pizarra

Les plateaux en mélamine noirs convainquent grâce au aspect de l'ardoise

| | cm | ↑ cm | Griff / handle cm |
|-------|---------|------|-------------------|
| 84258 | 40 x 20 | 1,5 | 13 |
| 84259 | 48 x 20 | 1,5 | 13 |
| | Ø cm | ↑ cm | Griff / handle cm |
| 84257 | 30 | 1,5 | 12 |



7 tlg.
7 pcs.

Serving-Box

serving box
caja comida
boîte-repas



7 teiliges Set:

- 1 Box + 1 Deckel
- 1 Schale groß (23 x 14 x 6 cm, 1,4 ltr.)
- 1 Schale mittel (14 x 11,5 x 6 cm, 0,6 ltr.)
- 2 Schalen klein (11,5 x 7 x 6 cm, 0,25 ltr.)
- 1 Antirutsch-Matte (26 x 21 cm)

7 pcs.:

- 1 box + 1 cover
- 1 bowl large (23 x 14 x 6 cm, 1,4 ltr.)
- 1 bowl medium (14 x 11,5 x 6 cm, 0,6 ltr.)
- 2 bowls small (11,5 x 7 x 6 cm, 0,25 ltr.)
- 1 non-slip mat (26 x 21 cm)

set de 7:

- 1 caja + 1 tapa
- 1 cuenco, grande (23 x 14 x 6 cm, 1,4 ltr.)
- 1 cuenco mediano (14 x 11,5 x 6 cm, 0,6 ltr.)
- 2 cuencos pequeños (11,5 x 7 x 6 cm, 0,25 ltr.)
- 1 esterilla antideslizante (26 x 21 cm)

set de 7:

- 1 boîte + 1 couvercle
- 1 bol, grand (23 x 14 x 6 cm, 1,4 ltr.)
- 1 bol moyen (14 x 11,5 x 6 cm, 0,6 ltr.)
- 2 bols petits (11,5 x 7 x 6 cm, 0,25 ltr.)
- 1 tapis antidérapant (26 x 21 cm)

| | Ø cm | ↑ cm | Farbe / colour |
|-------|---------|------|----------------|
| 85088 | 30 x 25 | 8 | ■ |



stapelbar
stackable



GN Tablett „ZERO“

GN tray
GN bandeja
GN plateau



glatte, hochglänzende Oberfläche
smooth and shiny surface
superficie lisa con acabado brillante
surface lisse et finition brillante

| | cm | ↑ cm | GN | Farbe / Colour |
|-------|-------------|------|-----|----------------|
| 84185 | 53,0 x 32,5 | 1,5 | 1/1 | |
| 84186 | 32,5 x 26,5 | 1,5 | 1/2 | |
| 84187 | 32,5 x 17,6 | 1,5 | 1/3 | |
| 84188 | 26,5 x 16,2 | 1,5 | 1/4 | |
| 84189 | 53,0 x 16,2 | 1,5 | 2/4 | |

passende Hauben / suitable covers / campanas adecuadas / cloches appropriées

| | cm | ↑ cm | * mm | GN |
|-------|-------------|------|------|-----|
| 11042 | 53,0 x 32,5 | 9,5 | 3 | 1/1 |
| 11041 | 32,5 x 26,5 | 9,5 | 3 | 1/2 |
| 11043 | 32,5 x 17,6 | 10,5 | 3 | 1/3 |
| 11044 | 53,0 x 16,2 | 10,5 | 3 | 2/4 |



mit Antirutschfüßchen
with non-slip feet



Oberflächenansicht
surface view

GN Tablett „DRIFTWOOD“

GN tray
GN bandeja
GN plateau



die Melaminplatten (Holzoptik) haben eine leicht wellige Oberfläche und wirken optisch wie aus Holz gefertigt

the melamine trays (wood look) have a slightly wavy surface and look visually as made of natural wood

las bandejas de melamina (imitación madera) tienen una superficie ligeramente ondulada y parecen estar hechas de madera natural

les plateaux de mélamine (imitation bois) ont une surface légèrement ondulée et donnent une impression visuelle de bois naturelle

| | cm | ↑ cm | GN |
|-------|-------------|------|-----|
| 84180 | 53,0 x 32,5 | 1,5 | 1/1 |
| 84181 | 32,5 x 26,5 | 1,5 | 1/2 |
| 84182 | 32,5 x 17,6 | 1,5 | 1/3 |





CIRCLE



Tablett „CIRCLE“
 plate / tray
 plato / bandeja
 assiette / plateau



| | Ø cm | ↑ cm | Farbe / Colour |
|-------|------|------|----------------|
| 84875 | 32,0 | 3,5 | |
| 84876 | 40,5 | 5,5 | |

LA VIDA



Tablett „LA VIDA“
 plate / tray
 plato / bandeja
 assiette / plateau



| | Ø cm | ↑ cm | Farbe / Colour |
|-------|------|------|----------------|
| 84161 | 32,0 | 3,5 | |
| 84170 | 40,5 | 5,5 | |
| <hr/> | | | |
| | Ø cm | ↑ cm | Farbe / Colour |
| 84171 | 32,0 | 3,5 | |
| 84172 | 40,5 | 5,5 | |



MARONE

Eine derbe Oberflächenstruktur schafft ein natürliches Erscheinungsbild.

Die schwarzen Schalenvarianten mit braunem Rand inszenieren Ihr Gericht sehr stilvoll.

A rough surface structure creates a natural appearance.

The black bowls and trays with brown border stage your dishes in a very stylish way.

La estructura rugosa de la superficie crea una apariencia natural.

Los diferentes cuencos negros con borde marrón ponen con mucho estilo en escena sus platos.

La structure de surface rugueuse crée une apparence naturelle.

Les différents bols noirs avec rebord marron mettent élégamment en scène vos plats.



Blattschale „MARONE“ leaf fuente en forma de hoja plateau feuille



| | cm | ↑ cm | ltr. |
|-------|-----------|------|------|
| 84100 | 25,5 x 14 | 5,5 | 0,4 |
| 84101 | 36,0 x 19 | 8,0 | 0,9 |



Schale „MARONE“ bowl cuenco bol



| | cm | ↑ cm | ltr. |
|-------|-----------|------|------|
| 84731 | 16,5 x 10 | 5,5 | 0,25 |
| 84732 | 22,0 x 13 | 7,5 | 0,6 |
| 84733 | 27,5 x 19 | 9,0 | 1,4 |



Oberflächenansicht
surface view



84107 **0,05 ltr.**



84108 **0,04 ltr.**

Schale „MARONE“

bowl
cuenco
bol



| | Ø cm | ↑ cm | ltr. |
|-------|------|------|------|
| 84107 | 8,5 | 2,5 | 0,05 |
| 84108 | 11,5 | 3,0 | 0,04 |



84115 **0,2 ltr.**



84116 **0,2 ltr.**

Schale „MARONE“

bowl
cuenco
bol



| | Ø cm | ↑ cm | ltr. |
|-------|------|------|------|
| 84115 | 11 | 3,5 | 0,13 |
| 84116 | 14 | 4,0 | 0,20 |



84109 **0,2 ltr.**

Schale „MARONE“

bowl
cuenco
bol



| | Ø cm | ↑ cm | ltr. |
|-------|------|------|------|
| 84109 | 11 | 5,5 | 0,2 |



84111 **0,8 ltr.**

Schale „MARONE“

bowl
cuenco
bol



| | Ø cm | ↑ cm | ltr. |
|-------|------|------|------|
| 84110 | 14 | 6,0 | 0,30 |
| 84111 | 19 | 8,0 | 0,80 |
| 84112 | 21 | 8,5 | 1,00 |
| 84113 | 24 | 9,5 | 1,40 |



84174 **2,0 ltr.**

Schale „MARONE“

bowl
cuenco
bol



| | Ø cm | ↑ cm | ltr. |
|-------|------|------|------|
| 84174 | 30,5 | 8,5 | 2 |

MARONE

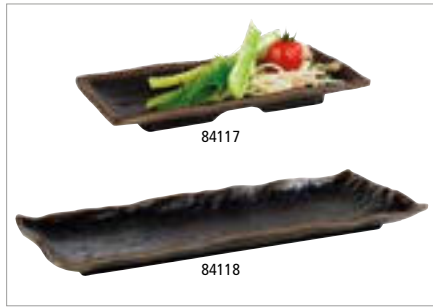

Tablett „MARONE“

tray
bandeja
plateau



MAX
70°C



| | cm | ↑ cm |
|-------|-------------|------|
| 84117 | 19,5 x 9,5 | 2 |
| 84118 | 39,0 x 16,0 | 3 |



Tablett „MARONE“

tray
bandeja
plateau



MAX
70°C



| | cm | ↑ cm |
|-------|-------------|------|
| 84119 | 32,5 x 23,5 | 4,5 |



Tablett „MARONE“

tray
bandeja
plateau



MAX
70°C



| | cm | ↑ cm |
|-------|-----------|------|
| 84104 | 22,5 x 15 | 3 |
| 84105 | 27,5 x 11 | 2 |



Tablett „MARONE“

tray
bandeja
plateau



MAX
70°C



| | cm | ↑ cm |
|-------|-------------|------|
| 84103 | 14,5 x 14,5 | 2 |



Tablett „MARONE“

tray
bandeja
plateau



MAX
70°C



| | cm | ↑ cm |
|-------|-------------|------|
| 84106 | 26,5 x 16,5 | 4 |



Teller „MARONE“

plate
plato
assiette



MAX
70°C



| | Ø cm | ↑ cm |
|-------|------|------|
| 84728 | 16,0 | 2,5 |
| 84729 | 20,5 | 2,5 |
| 84730 | 28,0 | 3,5 |

DARK WAVE



GN Tablett „DARK WAVE“

GN tray
GN bandeja
GN plateau



| | cm | ↑ cm | GN |
|-------|-------------|------|-----|
| 84900 | 53,0 x 32,5 | 2 | 1/1 |
| 84901 | 32,5 x 26,5 | 2 | 1/2 |
| 84902 | 32,5 x 17,6 | 2 | 1/3 |
| 84903 | 53,0 x 16,2 | 2 | 2/4 |



mit Antirutschfüßchen
with non-slip feet

DARK WAVE



Tablett „DARK WAVE“

tray
bandeja
plateau



MAX
70°C



| | cm | ↑ cm |
|-------|---------|------|
| 84904 | 14 x 14 | 2 |



Tablett „DARK WAVE“

tray
bandeja
plateau



MAX
70°C



| | cm | ↑ cm |
|-------|-----------|------|
| 84905 | 23 x 10,5 | 1,5 |
| 84906 | 29 x 12,0 | 1,5 |



Teller „DARK WAVE“

plate
plato
assiette



MAX
70°C



| | Ø cm | ↑ cm |
|-------|------|------|
| 84907 | 14,5 | 1,5 |
| 84908 | 22,0 | 2,0 |
| 84909 | 27,0 | 2,5 |



Schale „DARK WAVE“

bowl
cuenco
bol



MAX
70°C



| | Ø cm | ↑ cm | litr. |
|-------|------|------|-------|
| 84910 | 17,5 | 5,0 | 0,50 |
| 84911 | 22,5 | 5,0 | 0,75 |
| 84912 | 32,0 | 3,5 | – |

ZEN

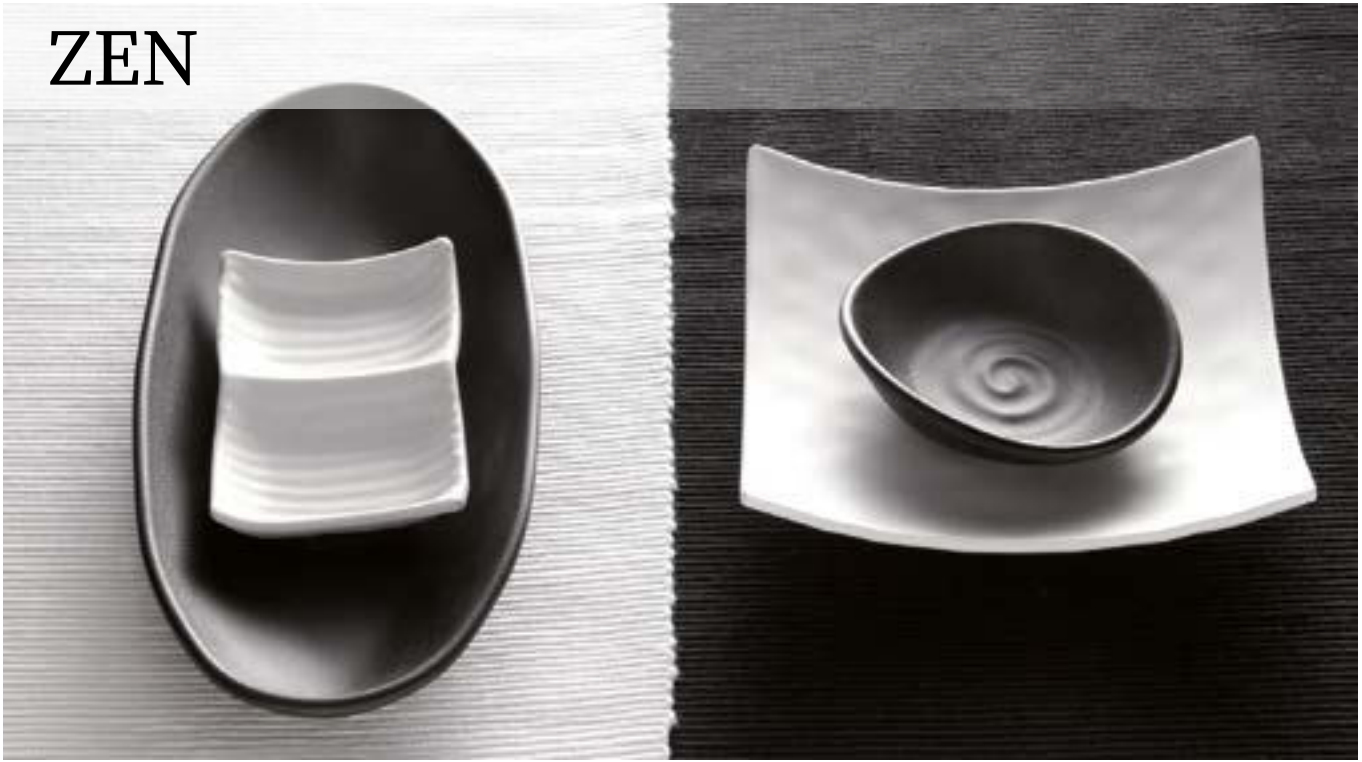

Fernöstliche Tisch- und Buffetartikel präsentiert die Serie ZEN. Die Optik entspricht dem japanischen Steingut.

The ZEN series presents Far Eastern table and buffet articles. The appearance is that of Japanese stoneware.

La colección ZEN presenta artículos de buffet y mesa para la cocina oriental. Su aspecto recuerda al gres japonés.

La collection ZEN présente des articles de buffet et de table pour la cuisine orientale. L'aspect de la mélamine rappelle le grès japonais.



Schale „ZEN“

bowl
cuenco
bol



| | Ø cm | ↑ cm | ltr | Farbe / Colour |
|-------|------|------|-----|----------------|
| 83929 | 31 | 8,5 | 2,5 | ■ |



Schale „ZEN“

bowl
cuenco
bol



| | Ø cm | ↑ cm | ltr | Farbe / Colour |
|-------|------|------|------|----------------|
| 84355 | 22,5 | 12,5 | 0,80 | ■ |



Schale „ZEN“

bowl
cuenco
bol



| | cm | ↑ cm | ltr | Farbe / Colour |
|-------|---------|------|------|----------------|
| 83712 | 21 x 21 | 11 | 1,40 | ■ |



Schale „ZEN“

bowl
cuenco
bolMAX
70°C

| | Ø cm | ↑ cm | ltr. | Farbe / Colour |
|-------|------|------|------|----------------|
| 84348 | 10,0 | 7,0 | 0,08 | ■ |
| 84349 | 10,0 | 7,0 | 0,08 | ■ |
| 84351 | 12,5 | 8,5 | 0,15 | ■ |
| 84353 | 16,0 | 10,0 | 0,30 | ■ |

stapelbar
stackable

Schale „ZEN“

bowl
cuenco
bolMAX
70°C

| | cm | ↑ cm | ltr. | Farbe / Colour |
|-------|-------------|------|------|----------------|
| 83735 | 25,0 x 13,5 | 4 | 0,25 | ■ |
| 83739 | 30,5 x 17,5 | 5 | 0,60 | ■ |



Schale „ZEN“

bowl
cuenco
bolMAX
70°C

| | cm | ↑ cm | ltr. | Farbe / Colour |
|-------|-------------|------|------|----------------|
| 83716 | 17,5 x 17,5 | 7 | 0,5 | ■ |



Schale „ZEN“

bowl
cuenco
bolMAX
70°C

| | cm | ↑ cm | ltr. | Farbe / Colour |
|-------|-------------|------|------|----------------|
| 83725 | 10,5 x 10,5 | 3 | 0,06 | ■ |
| 83727 | 10,5 x 10,5 | 3 | 0,06 | ■ |



Dipschälchen „ZEN“

dip bowl
cuenco para dip
bol para dipMAX
70°C

| | Ø cm | ↑ cm | ltr. | Farbe / Colour |
|-------|------|------|------|----------------|
| 83721 | 8 | 1,5 | 0,03 | ■ |
| 83723 | 8 | 1,5 | 0,03 | ■ |



Schale „ZEN“

bowl
cuenco
bol

| | cm | ↑ cm | ltr. | Farbe / Colour |
|-------|---------|------|------|----------------|
| 83718 | 12 x 12 | 4 | 0,2 | |
| 83720 | 12 x 12 | 4 | 0,2 | |



Schale „ZEN“

bowl
cuenco
bol

| | cm | ↑ cm | ltr. | Farbe / Colour |
|-------|---------|------|------|----------------|
| 83726 | 13 x 11 | 3,5 | 0,1 | |
| 83728 | 13 x 11 | 3,5 | 0,1 | |



Schale „ZEN“

bowl
cuenco
bol

| | cm | ↑ cm | ltr. | Farbe / Colour |
|-------|---------|------|------|----------------|
| 83730 | 11 x 10 | 3 | 0,04 | |
| 83732 | 11 x 10 | 3 | 0,04 | |



Schale „ZEN“

bowl
cuenco
bol

| | cm | ↑ cm | ltr. | Farbe / Colour |
|-------|-------------|------|------|----------------|
| 83722 | 17,5 x 15,5 | 5,5 | 0,2 | |
| 83724 | 17,5 x 15,5 | 5,5 | 0,2 | |



Schale „ZEN“

bowl
cuenco
bol

| | cm | ↑ cm | ltr. | Farbe / Colour |
|-------|-------------|------|------|----------------|
| 83935 | 14,5 x 12,5 | 5 | 0,2 | |



Schale „ZEN“

bowl
cuenco
bol

| | Ø cm | ↑ cm | ltr. | Farbe / Colour |
|-------|------|------|------|----------------|
| 83932 | 11,5 | 4 | 0,15 | |
| 83933 | 11,5 | 4 | 0,15 | |



Schale „ZEN“

bowl
cuenco
bol



MAX
70°C



| | cm | ↑ cm | litr. | Farbe / Colour |
|-------|-------|------|-------|----------------|
| 83946 | 9 x 7 | 2,5 | 0,05 | ■ |
| 83947 | 9 x 7 | 2,5 | 0,05 | ■ |



Schale „ZEN“

bowl
cuenco
bol



MAX
70°C



| | cm | ↑ cm | Farbe / Colour |
|-------|--------|------|----------------|
| 83949 | 14 x 9 | 2,5 | ■ |



Tablett / Teller „ZEN“

tray / plate
bandeja / plato
plateau / assiette



MAX
70°C



| | Ø cm | ↑ cm | Farbe / Colour |
|-------|------|------|----------------|
| 83941 | 28 | 3 | ■ |



Tablett / Sushiboard „ZEN“

tray / sushiboard
bandeja para sushi
plateau sushi



MAX
70°C



| | cm | ↑ cm | Farbe / Colour |
|-------|------------|------|----------------|
| 83742 | 22,5 x 9,5 | 3 | ■ |
| 83744 | 22,5 x 9,5 | 3 | ■ |



Tablett / Sushiboard „ZEN“

tray / sushiboard
bandeja para sushi
plateau sushi



MAX
70°C



| | cm | ↑ cm | Farbe / Colour |
|-------|---------|------|----------------|
| 83740 | 22 x 12 | 3 | ■ |



Charakterstark und mit dem Anspruch an Funktionalität und Design präsentiert sich die Buffetserie SINUS. Die großzügigen Flächen für die Speisenpräsentation sind ausdrucksstark eingefasst und gewährleisten ein optimales Handling.

The SINUS buffet series is characterful and with a high standard of functionality and design. The spacious areas for the food presentation are expressively enclosed and ensure optimal handling in everyday dining.

La serie de buffet SINUS demuestra un caracter fuerte y tiene un alto nivel de funcionalidad y diseño. Las áreas espaciaosas para la presentación de la comida son expresivamente enmarcadas y aseguran un manejo óptimo en la gastronomía.

La série de buffet SINUS est pleine de caractère et avec un haut niveau de fonctionnalité et de design. Les zones spacieuses pour la présentation de la nourriture sont expressivement encadré et assurent une maniabilité optimale dans la restauration.



GN Tablett „SINUS“
 GN tray
 GN bandeja
 GN plateau

original APS melamine MAX 70°C

| | cm | ↑ cm | GN | Farbe / Colour |
|-------|-----------|------|-----|----------------|
| 84230 | 53 x 32,5 | 2 | 1/1 | White |
| 84231 | 53 x 16,2 | 2 | 2/4 | White |



Schale „SINUS“
 bowl
 cuenco
 bol

original APS melamine MAX 70°C

| | cm | ↑ cm | ltr. |
|-------|-------------|------|------|
| 84232 | 21,0 x 21,0 | 9,0 | 1,5 |
| 84233 | 25,0 x 25,0 | 11,0 | 2,4 |

HALFTONE



Fingerfood Löffel „HALFTONE“

party spoon
cuchara party
cuillère party



| | ∅ cm | ↑ cm | Farbe / Colour | VE / unit |
|-------|------|------|----------------|-----------|
| 84158 | 5,5 | 7 | | 24 |



Fingerfood Löffel „HALFTONE“

party spoon
cuchara party
cuillère party



| | cm | ↑ cm | Farbe / Colour | VE / unit |
|-------|------------|------|----------------|-----------|
| 84128 | 14,5 x 4,5 | 4,5 | | 12 |



Tablett „HALFTONE“

tray
bandeja
plateau



| | cm | ↑ cm |
|-------|-------------|------|
| 84125 | 24,5 x 15,0 | 3 |



Tablett „HALFTONE“

tray
bandeja
plateau



| | cm | ↑ cm |
|-------|---------|------|
| 84126 | 29 x 18 | 4 |

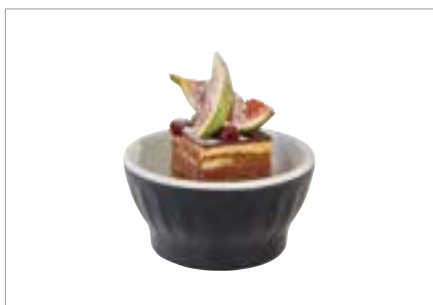

Schale „HALFTONE“

bowl
cuenco
bol



| | Ø cm | ↑ cm | litr. | VE / unit |
|-------|------|------|-------|-----------|
| 84217 | 8 | 4 | 0,1 | 12 |



84130

84134

Schale „HALFTONE“

bowl
cuenco
bol



| | cm | ↑ cm | litr. |
|-------|-------------|------|-------|
| 84130 | 11,5 x 7,0 | 4,0 | 0,05 |
| 84131 | 14,0 x 8,0 | 4,5 | 0,10 |
| 84132 | 15,0 x 9,5 | 5,0 | 0,15 |
| 84133 | 17,5 x 13,5 | 6,5 | 0,35 |
| 84134 | 24,0 x 17,5 | 7,5 | 0,8 |



Schale „HALFTONE“

bowl
cuenco
bol



| | Ø cm | ↑ cm | litr. |
|-------|------|------|-------|
| 84135 | 16,5 | 7,5 | 0,65 |



PADELLA



85150 1,5 ltr.

85151 3,0 ltr.

Schale „PADELLA“

bowl
cazuelita
plat 2 anses „cocotte“



| | Ø cm | ↑ cm | litr. | Griff / handle cm |
|-------|------|------|-------|-------------------|
| 85150 | 21 | 9 | 1,5 | 5 x 3,5 |
| 85151 | 28 | 9 | 3,0 | 5 x 3,5 |



stapelbar und rutschfest
stackable and nonslip

APART



GN Tablett „APART“

GN tray
GN bandeja
GN plateau



MAX
70°C



| | cm | ↑ cm | GN |
|-------|-------------|------|-----|
| 83828 | 53,0 x 32,5 | 2,5 | 1/1 |
| 83830 | 32,5 x 26,5 | 2,5 | 1/2 |



Dipschälchen „APART“

dip bowl
cuenco para dip
ramequin



MAX
70°C



| | Ø cm | ↑ cm | litr. |
|-------|------|------|-------|
| 83800 | 6,5 | 3,0 | 0,045 |



Dipschälchen „APART“

dip bowl
cuenco para dip
ramequin



MAX
70°C



| | cm | ↑ cm | litr. |
|-------|-----------|------|-------|
| 83808 | 6,5 x 6,5 | 3,0 | 0,05 |

CASCADE



Schale „CASCADE“

bowl
cuenco
bol



MAX
70°C



| | cm | ↑ cm | GN | litr. |
|-------|-------------|------|-----|-------|
| 83960 | 32,5 x 26,5 | 7,5 | 1/2 | 3,65 |
| 83962 | 26,5 x 16,2 | 7,5 | 1/4 | 1,50 |
| 83961 | 53 x 16,2 | 7,5 | 2/4 | 3,65 |



Außenmaße Gastronorm
size Gastronorm

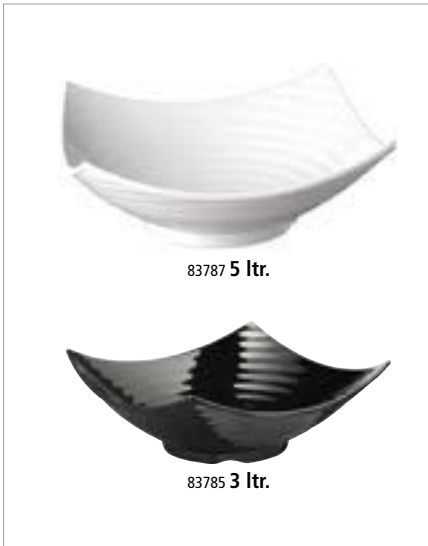

Schale „GLOBAL BUFFET“

bowl
cuenco
bol



| | cm | ↑ cm | ltr. | Farbe / Colour |
|-------|-------------|------|------|----------------|
| 83785 | 32,5 x 32,5 | 12,0 | 3,0 | White |
| 83787 | 40,0 x 40,0 | 13,5 | 5,0 | White |
| 84785 | 32,5 x 32,5 | 12,0 | 3,0 | Black |



Schale „GLOBAL BUFFET“

bowl
cuenco
bol



| | cm | ↑ cm | ltr. | Farbe / Colour |
|-------|-------------|------|------|----------------|
| 84464 | 35,5 x 31,5 | 14,0 | 2,5 | White |
| 84466 | 46,0 x 40,0 | 18,5 | 5,5 | White |



Schale „GLOBAL BUFFET“

bowl
cuenco
bol



| | cm | ↑ cm | ltr. | Farbe / Colour |
|-------|-------------|------|------|----------------|
| 83799 | 25,5 x 25,5 | 13,0 | 3,0 | White |
| 83788 | 32,0 x 32,0 | 16,5 | 4,5 | White |
| 83789 | 35,0 x 35,0 | 17,0 | 6,0 | White |
| 83790 | 40,0 x 40,0 | 17,5 | 8,0 | White |



Schale „GLOBAL BUFFET“

bowl
cuenco
bol



| | cm | ↑ cm | ltr. | Farbe / Colour |
|-------|---------|------|------|----------------|
| 84462 | 44 x 25 | 20 | 3,3 | White |



Schale „LEAF“

bowl
cuenco
bol



| | cm | ↑ cm | ltr. | Farbe / Colour |
|-------|-----------|------|------|----------------|
| 84200 | 42 x 19,5 | 6,5 | 1,0 | White |
| 84202 | 50 x 23,0 | 7,5 | 1,5 | White |

FLYING BUFFET



Fingerfood-Teller „FLYING BUFFET“

fingerfood plate
plato para el aperitivo
assiette pour apéritif



| | cm | ↑ cm | Farbe / Colour |
|-------|-----------|-----------|----------------|
| 83878 | 9,5 x 9,5 | 1,5 / 3,5 | White |
| 83879 | 9,5 x 9,5 | 1,5 / 3,5 | Black |



Schale „FLOAT“

bowl
cuenco
bol



| | cm | ↑ cm | Farbe / Colour |
|-------|-------|------|----------------|
| 83912 | 9 x 9 | 4,5 | White |
| 83913 | 9 x 9 | 4,5 | Black |



GN Tablett „APART“

GN tray
GN bandeja
GN plateau



| | cm | ↑ cm | GN |
|-------|-------------|------|-----|
| 83828 | 53 x 32,5 | 2,5 | 1/1 |
| 83830 | 32,5 x 26,5 | 2,5 | 1/2 |



GN Edelstahl Tablett

GN stainless steel platter
GN bandeja de acero inoxidable
GN plateau en acier inox



| | cm | GN |
|-------|-----------|-----|
| 11119 | 53 x 32,5 | 1/1 |



FLOAT



- Ideal für den Thekenbereich
- stapelbar mit Löffel und Deckel
- Schalenboden fixiert sich auf dem Deckel
- rutschfest (Antirutschfüßchen)

- ideal for the counter area
- stackable with spoon and lid
- the bottom of the bowl is fixed on the lid
- non-slip (with non-slip feet)

- ideal para la zona del mostrador
- apilable con cuchara y tapa
- el fondo del cuenco se fija en la tapa
- antideslizante (con pies antideslizantes)

- idéal pour l'aire de comptoir
- empilable avec cuillère et couvercle
- le fond du bol se fixe sur le couvercle
- antidérapant (avec pieds antidérapants)



Schale „FLOAT“ bowl cuenco bol



| | Ø cm | ↑ cm | ltr. | Farbe / Colour |
|-------|------|------|------|----------------|
| 83900 | 5,5 | 3,0 | 0,03 | White |
| 83902 | 9,0 | 4,5 | 0,15 | White |
| 83904 | 13,0 | 6,5 | 0,45 | White |
| 83906 | 15,0 | 7,5 | 0,70 | White |
| 83908 | 20,5 | 10,0 | 1,90 | White |
| 83901 | 5,5 | 3,0 | 0,03 | Black |
| 83903 | 9,0 | 4,5 | 0,15 | Black |
| 83905 | 13,0 | 6,5 | 0,45 | Black |
| 83907 | 15,0 | 7,5 | 0,70 | Black |
| 83909 | 20,5 | 10,0 | 1,90 | Black |

FLOAT



Schale „FLOAT“

bowl
cuenco
bol



| | cm | ↑ cm | ltr. | Farbe / Colour |
|-------|-------------|------|------|----------------|
| 83910 | 5,5 x 5,5 | 3,0 | 0,03 | White |
| 83912 | 9,0 x 9,0 | 4,5 | 0,16 | White |
| 83914 | 12,5 x 12,5 | 6,0 | 0,50 | White |
| 83916 | 19,0 x 19,0 | 9,5 | 1,90 | White |
| 83918 | 25,0 x 25,0 | 12,0 | 4,70 | White |
| 83911 | 5,5 x 5,5 | 3,0 | 0,03 | Black |
| 83913 | 9,0 x 9,0 | 4,5 | 0,16 | Black |
| 83915 | 12,5 x 12,5 | 6,0 | 0,50 | Black |
| 83917 | 19,0 x 19,0 | 9,5 | 1,90 | Black |
| 83919 | 25,0 x 25,0 | 12,0 | 4,70 | Black |



stapelbar
stackable



GN Tablett „FLOAT“

GN tray
GN bandeja
GN plateau



| | cm | ↑ cm | GN | Farbe / Colour |
|-------|-------------|------|-----|----------------|
| 83923 | 53,0 x 32,5 | 3 | 1/1 | White |
| 83925 | 32,5 x 26,5 | 3 | 1/2 | White |
| 83924 | 53,0 x 32,5 | 3 | 1/1 | Black |
| 83926 | 32,5 x 26,5 | 3 | 1/2 | Black |



Deckel „FLOAT“ mit Löffelaussparung

cover with notched for spoons
tapa con espacio para la cuchara
couverture avec encoche pour la louche



| | cm | ↑ cm | fits to |
|-------|---------|------|--------------|
| 83920 | Ø 20,5 | 1,3 | 83908, 83909 |
| 83921 | 19 x 19 | 1,3 | 83916, 83917 |
| 83922 | 25 x 25 | 1,3 | 83918, 83919 |

PURE



Tablett „PURE“

tray
bandeja
plateau

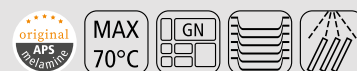

| | cm | ↑ cm | GN | Farbe / Colour |
|-------|-------------|------|------------|----------------|
| 83401 | 53,0 x 32,5 | 3 | 1/1 | |
| 83433 | 53,0 x 16,2 | 3 | 2/4 | |
| 83480 | 32,5 x 26,5 | 3 | 1/2 | |
| 83481 | 32,5 x 17,6 | 3 | 1/3 | |
| 83482 | 26,5 x 16,2 | 3 | 1/4 | |
| 83597 | 40,0 x 30,0 | 3 | Bäcker-Maß | |

| | cm | ↑ cm | GN | Farbe / Colour |
|-------|-------------|------|------------|----------------|
| 83479 | 53,0 x 32,5 | 3 | 1/1 | |
| 83434 | 53,0 x 16,2 | 3 | 2/4 | |
| 83490 | 32,5 x 26,5 | 3 | 1/2 | |
| 83491 | 32,5 x 17,6 | 3 | 1/3 | |
| 83492 | 26,5 x 16,2 | 3 | 1/4 | |
| 83592 | 40,0 x 30,0 | 3 | Bäcker-Maß | |



Tablett „PURE“

tray
bandeja
plateau



| | cm | ↑ cm | Farbe / Colour |
|-------|-------------|------|----------------|
| 83403 | 35,5 x 18,0 | 3 | |
| 83417 | 30,0 x 21,0 | 3 | |
| 83402 | 53,0 x 18,0 | 3 | |



Tablett quadratisch „PURE“

tray square
bandeja cuadrada
plateau carré



| | cm | ↑ cm | Farbe / Colour |
|-------|-------------|------|----------------|
| 83418 | 18,0 x 18,0 | 3 | |
| 83407 | 21,0 x 21,0 | 3 | |
| 83406 | 26,5 x 26,5 | 3 | |
| 83405 | 37,0 x 37,0 | 3 | |
| 83404 | 51,0 x 51,0 | 3 | |



Tablett / Teller „PURE“

tray / plate
bandeja / plato
plateau / assiette



| | Ø cm | ↑ cm | Farbe / Colour |
|-------|------|------|----------------|
| 83884 | 31 | 2,5 | White |
| 83869 | 38 | 2,5 | White |
| 83484 | 51 | 2,5 | White |



Teller, rund „CASUAL“

plate, round
plato, redondo
assiette, ronde



| | Ø cm | ↑ cm | Farbe / Colour |
|-------|------|------|----------------|
| 83500 | 22,5 | 2,5 | White |
| 83514 | 26,5 | 2,5 | White |



Schale „PURE“

bowl
cuenco
bol



| | Ø cm | ↑ cm | ltr. | Farbe / Colour |
|-------|------|------|------|----------------|
| 83450 | 5,5 | 4,0 | 0,02 | White |
| 83419 | 9,0 | 4,5 | 0,09 | White |
| 83453 | 13,0 | 6,5 | 0,30 | White |
| 83455 | 15,0 | 7,5 | 0,45 | White |
| 83415 | 20,0 | 10,5 | 1,25 | White |
| | Ø cm | ↑ cm | ltr. | Farbe / Colour |
| 83451 | 5,5 | 4,0 | 0,02 | Black |
| 83452 | 9,0 | 4,5 | 0,09 | Black |
| 83454 | 13,0 | 6,5 | 0,30 | Black |



Schale „PURE“

bowl
cuenco
bol



| | cm | ↑ cm | ltr. | Farbe / Colour |
|-------|-------------|------|------|----------------|
| 84424 | 6,5 x 6,5 | 3,0 | 0,05 | White |
| 83414 | 9,0 x 9,0 | 4,0 | 0,14 | White |
| 83410 | 12,5 x 12,5 | 6,5 | 0,40 | White |
| 83409 | 19,0 x 19,0 | 9,0 | 1,50 | White |
| 83408 | 25,0 x 25,0 | 12,0 | 3,80 | White |
| 84425 | 32,0 x 32,0 | 14,0 | 8,0 | White |
| | cm | ↑ cm | ltr. | Farbe / Colour |
| 84426 | 6,5 x 6,5 | 3,0 | 0,05 | Black |
| 83466 | 9,0 x 9,0 | 4,0 | 0,14 | Black |
| 83467 | 12,5 x 12,5 | 6,5 | 0,40 | Black |
| 83468 | 19,0 x 19,0 | 9,0 | 1,50 | Black |
| 83469 | 25,0 x 25,0 | 12,0 | 3,80 | Black |
| 84427 | 32,0 x 32,0 | 14,0 | 8,0 | Black |



Schale „PURE COLOR“

bowl
cuenco
bol



| | cm | ↑ cm | ltr. | Farbe / Colour |
|-------|---------|------|------|----------------|
| 85260 | 19 x 19 | 9 | 1,5 | sand |
| 85261 | 25 x 25 | 12 | 3,8 | sand |
| 85266 | 19 x 19 | 9 | 1,5 | olive |
| 85267 | 25 x 25 | 12 | 3,8 | olive |



Schale „SLATE“

bowl
cuenco
bol



| | cm | ↑ cm | ltr. |
|-------|---------|------|------|
| 84244 | 19 x 19 | 9 | 1,5 |
| 84245 | 25 x 25 | 12 | 3,8 |



Deckel „PURE“, 5er Set

cover, 5 pcs.
tapa, set de 5
couverture, set de 5



Hygienischer Schutz für Ihre Speisen

- dichtschießend
- schwappsicherer Transport

protection for your food

- tightly closing

- slish-proof transport

protección de alimentos

- con cierre hermético

- transporte sin salpicaduras

protection des aliments

- fermeture hermétique

- transport sans éclaboussures

| | cm | ↑ cm | pcs. | fits to |
|-------|-------------|------|------|--|
| 83603 | 13,0 x 13,0 | 0,5 | 5 | 83410, 83467 |
| 83604 | 19,5 x 19,5 | 0,5 | 5 | 83409, 83468, 84244, 84830, 85261, 85267, 79004, 79005 |



Deckel „PURE“ mit Löffelaussparung

cover with notched for spoons
tapa con espacio para la cuchara
couvertcle avec encoche pour la louche



| | cm | ↑ cm | fits to |
|-------|---------|------|--|
| 83600 | 19 x 19 | 1,5 | 84409, 84417, 84422, 83409, 83468, 83572, 83573 |
| 83601 | 25 x 25 | 1,5 | 84408, 84418, 84423, 84430, 83575, 83574, 83469, 83408 |



mit Deckel stapelbar
stackable with cover



Schale „PURE“

bowl
cuenco
bol



| | cm | ↑ cm | litr. |
|-------|-------------|------|-------|
| 83498 | 38,5 x 15,5 | 7,5 | 1,50 |
| 83499 | 51,0 x 15,5 | 7,5 | 2,40 |



Tablett

tray
bandeja
plateau



Edelstahl matt poliert, passend für 2 Melamin-Schalen
stainless steel matt polished, for 2 melamine bowls
acero inoxidable pulido mate, para 2 cuencos de melamina
acier inox poli mat, pour 2 bols de mélamine

| | cm |
|-------|---------|
| 30120 | 20 x 11 |

Edelstahl matt poliert, passend für 6 Melamin-Schalen
stainless steel matt polished, for 6 melamine bowls
acero inoxidable pulido mate, para 6 cuencos de melamina
acier inox poli mat, pour 6 bols de mélamine

| | cm |
|-------|---------|
| 30121 | 29 x 20 |

Schale „PURE COLOR“ / bowl / cuenco / bol

| | cm | ↑ cm | litr. | Farbe / Colour |
|-------|-------|------|-------|----------------|
| 83414 | 9 x 9 | 4 | 0,14 | White |
| 83466 | 9 x 9 | 4 | 0,14 | Black |



GN Tablett „FRAMES“

GN tray
GN bandeja
GN plateau



| | cm | ↑ cm | GN |
|-------|-------------|------|-----|
| 84046 | 53,0 x 32,5 | 2 | 1/1 |
| 84047 | 32,5 x 26,5 | 2 | 1/2 |
| 84048 | 32,5 x 17,6 | 2 | 1/3 |

ENAMEL LOOK



Teller „ENAMEL LOOK“

plate
plato
assiette



| | Ø cm | ↑ cm | Farbe / Colour |
|-------|------|------|----------------|
| 84950 | 20,5 | 2,0 | |
| 84951 | 24,5 | 2,5 | |

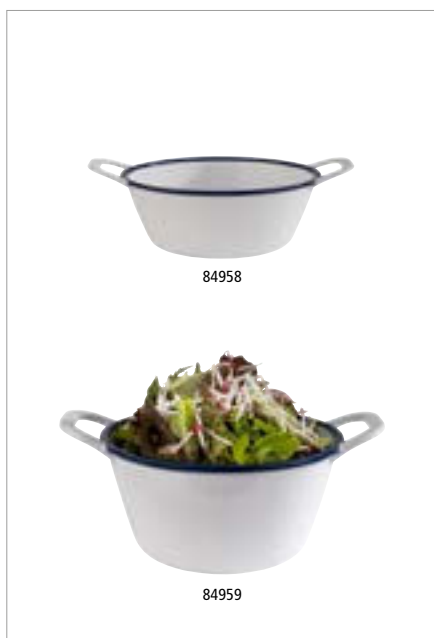

Schale „ENAMEL LOOK“

bowl
cuenco
bol



| | cm | ↑ cm | litr. | Farbe / Colour |
|-------|-------------|------|-------|----------------|
| 84958 | 15,0 x 11,5 | 6,5 | 0,30 | |
| 84959 | 21,5 x 16,5 | 9,5 | 1,00 | |



Schale „ENAMEL LOOK“

bowl
cuenco
bol



| | Ø cm | ↑ cm | litr. | Farbe / Colour |
|-------|------|------|-------|----------------|
| 84490 | 5,5 | 4,0 | 0,02 | |
| 84491 | 9,5 | 4,5 | 0,09 | |
| 84492 | 13,0 | 6,5 | 0,30 | |

CASUAL



Schälchen „CASUAL MINI“

bowl
cuenco
bol mini



| | cm | ↑ cm | ltr. | Farbe / Colour |
|-------|-----|------|------|----------------|
| 83880 | 6,0 | 2,5 | 0,02 | White |
| 83881 | 7,5 | 3,5 | 0,05 | White |



Schale „CASUAL MAXI“

bowl
cuenco
bol



| | Ø cm | ↑ cm | ltr. | Farbe / Colour |
|-------|------|------|------|----------------|
| 83696 | 10 | 4,5 | 0,15 | White |
| 83698 | 12 | 5,5 | 0,25 | White |
| 83700 | 14 | 6,5 | 0,50 | White |
| 83704 | 20 | 9,2 | 1,80 | White |
| 83702 | 23 | 10,5 | 2,50 | White |

| | Ø cm | ↑ cm | ltr. | Farbe / Colour |
|-------|------|------|------|----------------|
| 83697 | 10 | 4,5 | 0,15 | Black |
| 83699 | 12 | 5,5 | 0,25 | Black |
| 83701 | 14 | 6,5 | 0,50 | Black |
| 83705 | 20 | 9,2 | 1,80 | Black |
| 83703 | 23 | 10,5 | 2,50 | Black |

Deckel „FLOAT“ mit Löffelaussparung / cover with notched for spoons / tapa con espacio para la cuchara / couvercle avec encoche pour la louche

| | Ø cm | ↑ cm | fits to |
|-------|------|------|--------------|
| 83920 | 20,5 | 1,3 | 83704, 83705 |



Schale „CASUAL“

bowl
cuenco
bol



| | cm | ↑ cm | ltr. |
|-------|-------------|------|------|
| 84221 | 26,5 x 10,5 | 6,5 | 1,0 |



83605 Ø 8 cm

passend zu Schalen Ø 7,5 cm
fits to bowls Ø 7,5 cm



83606 Ø 14,5 cm

passend zu Schalen Ø 14 cm
fits to bowls Ø 14 cm



83607 Ø 20,5 cm

passend zu Schalen Ø 20 cm
fits to bowls Ø 20 cm

Deckel „CASUAL“, 5er Set

cover, 5 pcs.

tapa, set de 5

couvercle, set de 5



Hygienischer Schutz für Ihre Speisen

dichtschließend, schwappsicherer Transport

protection for your food

tightly closing, slosh-proof transport

protección de alimentos, con cierre hermético, transporte sin salpicaduras

protection des aliments

fermeture hermétique, transport sans éclaboussures

| | Ø cm | ↑ cm | fits to | pcs. |
|-------|------|------|---|------|
| 83605 | 8,0 | 0,5 | 11866, 83881, 15400, 15416, 15461, 15462, 15467, 40655, 40656 | 5 |
| 83606 | 14,5 | 0,5 | 11865, 83700, 83701, 85104, 85105, 85107 | 5 |
| 83607 | 20,5 | 0,5 | 83704, 83705, 15404, 15420 | 5 |



stapelbar
stackable



84215



84216

Schale „CASUAL“

bowl

cuenco

bol



| | Ø cm | ↑ cm | ltr. | Farbe / Colour |
|-------|------|-----------|------|----------------|
| 84215 | 10 | 6,5 / 8,5 | 0,2 | _____ |
| 84216 | 12 | 7,5 / 9,5 | 0,3 | _____ |



Schale „CASUAL“

bowl

cuenco

bol



| | Ø cm | ↑ cm | ltr. | Farbe / Colour |
|-------|------|------|------|----------------|
| 84295 | 10 | 7 | 0,13 | _____ |



Dipschale „CASUAL“

dip tray

bandeja para dips

plateau pour dips



| | cm | ↑ cm | Farbe / Colour |
|-------|--------|------|----------------|
| 84220 | 29 x 9 | 3 | _____ |



83780



83798



83777

Dipschälchen „CASUAL“

dip bowl

cuenco para dip

ramequin



| | Ø cm | ↑ cm | ltr. | Farbe / Colour | VE / unit |
|-------|------|------|------|----------------|-----------|
| 83780 | 6,0 | 4,0 | 0,05 | _____ | 24 |
| 83781 | 7,5 | 4,0 | 0,07 | _____ | 24 |
| 83782 | 8,0 | 4,5 | 0,08 | _____ | 24 |
| 83783 | 8,5 | 4,5 | 0,12 | _____ | 24 |
| 83798 | 6,0 | 4,0 | 0,05 | _____ | 24 |
| 83777 | 6,0 | 3,5 | 0,04 | _____ | 24 |

NATURAL COLLECTION



Blattschale „NATURAL COLLECTION“ leaf fuente en forma de hoja plateau feuille



| | cm | ↑ cm | Farbe / Colour |
|-------|---------|------|----------------|
| 83438 | 45 x 24 | 3,0 | — |
| 83441 | 53 x 29 | 3,5 | — |

| | cm | ↑ cm | Farbe / Colour |
|-------|---------|------|----------------|
| 83437 | 36 x 16 | 3,0 | — |
| 83440 | 45 x 24 | 3,0 | — |
| 83443 | 53 x 29 | 3,5 | — |



Fass, 2-teilig bowl cuenco bol



2-teilig: Unterteil / Schale, Edelstahlschale
2 pcs.: lower part / bowl, stainless steel bowl
set de 2: parte inferior / cuenco, cuenco de acero inoxidable
set de 2: partie inférieure / bol, bol en acier inox

| | Ø cm | ↑ cm |
|-------|------|------|
| 85250 | 26 | 16 |

Unterteil / Unterteil / Unterteil / Unterteil

| | Ø cm | ↑ cm | ltr. |
|-------|------|------|------|
| 85251 | 25 | 16 | 4,5 |

Edelstahlschale / Edelstahlschale / Edelstahlschale / Edelstahlschale

| | Ø cm | ↑ cm | ltr. |
|-------|------|------|------|
| 85252 | 26 | 9 | 3,0 |

passender Deckel mit Löffelaussparung / suitable cover with notched for spoons / tapa adecuada con espacio para la cuchara / couvercle appropriée avec encoche pour la louche

| | Ø cm | ↑ cm |
|-------|------|------|
| 83920 | 20,5 | 1,3 |



Unterteil mit Eis füllen für perfekte Kühlung sensibler Speisen
fill the bottom part with ice for perfect cooling of sensitive dishes

BRÖTCHENSCHÜTTE



85140



85140



85141



85141

Tablett „BRÖTCHENSCHÜTTE“

tray
bandeja
plateau

| | cm | ↑ cm | Farbe / Colour |
|-------|---------|------|----------------|
| 85140 | 41 x 18 | 3,0 | |
| 85141 | 41 x 18 | 3,0 | |

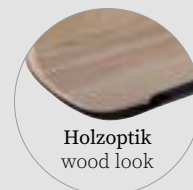

85140

Holzoptik
wood lookGriffbereich mit Aufhängeloch
handle area with hanging hole

85141

Schieferoptik
slate lookPräsentationsmöglichkeit
presentation example



Schale, 2-teilig „FRIDA“

bowl, 2 pcs.
cuenca, set de 2
bol, set de 2



inklusive Abtropfeinsatz
including drip tray
con bandeja recoge gotas
avec égouttoir

| | Ø cm | ↑ cm |
|-------|------|------|
| 85230 | 25,5 | 6 |
| 85231 | 33,0 | 6 |

Buffetständer, mit schwarzer Antirutschbeschichtung, für Schalen Nr. 85230, 85231

buffet stand, with black anti-slide coating, for bowls no. 85230, 85231
soporte para buffet, con revestimiento antideslizante negro, para cuencos 85230, 85231
présentoir buffet, avec revêtement antidérapant noir, pour bols 85230, 85231

| | Ø cm | ↑ cm |
|-------|-----------|------|
| 33282 | 23 / 30,5 | 17 |



Präsentationsmöglichkeit
presentation example



Servier- und Tortenplatte „CASUAL“

cake plate
porta pasteles
présentoir à gâteaux



| | Ø cm | ↑ cm |
|-------|------|------|
| 83890 | 31 | 8 |
| 83891 | 31 | 16 |



Servier- und Tortenplatte „CASUAL“

cake plate
porta pasteles
présentoir à gâteaux



| | cm | ↑ cm |
|-------|---------|------|
| 83892 | 31 x 31 | 8 |
| 83893 | 31 x 31 | 16 |



Torten- / Konditorplatte

cake stand
soporte para pastel
présentoir à gâteaux



Rand fixiert die Haube, mit Antirutsch-Füßchen
carved edge fixes the cover, with non-slip feet
ranura para fijar bien la campana, con pies antideslizantes
bord rainuré pour maintenir ferme la cloche, avec pieds antidérapants

| | Ø cm | ↑ cm | Farbe / Colour |
|-------|------|------|----------------|
| 00468 | 31,0 | 3,5 | White |
| 00469 | 31,0 | 3,5 | Black |



Schale „BALANCE“

bowl
cuenco
bol



| | Ø cm | ↑ cm | ltr. | Farbe / Colour |
|-------|------|------|------|----------------|
| 84040 | 14,5 | 9,0 | 0,4 | White |
| 84041 | 21,0 | 13,0 | 1,5 | White |
| 84042 | 24,5 | 15,0 | 2,5 | White |
| 84043 | 30,0 | 19,5 | 5,0 | White |

| | Ø cm | ↑ cm | ltr. | Farbe / Colour |
|-------|------|------|------|----------------|
| 85040 | 14,5 | 9,0 | 0,4 | Black |
| 85041 | 21,0 | 13,0 | 1,5 | Black |
| 85042 | 24,5 | 15,0 | 2,5 | Black |
| 85043 | 30,0 | 19,5 | 5,0 | Black |

Buffetständer „KING“ / buffet stand / soporte para buffet / présentoir buffet

| | Ø cm | ↑ cm |
|-------|------|------|
| 03622 | 15 | 14 |
| 03623 | 15 | 21 |



Tablett / Teller

tray / plate
bandeja / plato
plateau / assiette



| | Ø cm | ↑ cm | Farbe / Colour |
|-------|------|------|----------------|
| 83869 | 38 | 2,5 | White |

Rolltophaube mit verchromtem Kugelgriff

rolltop cover with chrome plated handle
campana abatible con pomo cromado
cloche basculante avec bouton chromé



| | Ø cm | ↑ cm |
|-------|------|------|
| 18388 | 38 | 20 |



Frischhalte-Haube

cover
campana
cloche



| | Ø cm | ↑ cm |
|-------|------|------|
| 06510 | 30 | 11,5 |

mit verchromtem Griff / with chrom plated handle / con botón cromado / avec bouton chromé

| | Ø cm | ↑ cm |
|-------|------|------|
| 06512 | 30 | 11,5 |

CUTLERY REST



Besteckablage „SMALL WAVE“
cutlery rest
reposa cuchara
pose-cuillère



| | cm | ↑ cm |
|-------|---------|------|
| 83897 | 26 x 13 | 4,5 |



Besteckablage „BOWL“
cutlery rest
reposa cuchara
pose-cuillère



| | cm | ↑ cm | ltr. |
|-------|-----------|------|------|
| 83803 | 22,5 x 11 | 6 | 0,5 |



Besteckablage „SPOON“
cutlery rest
reposa cuchara
pose-cuillère



| | cm | ↑ cm |
|-------|-----------|------|
| 83801 | 26 x 10,5 | 5 |



Servierlöffel „PROFI“
serving spoon
cuchara para servir
cuillère de service



| | cm | → cm | Farbe / Colour |
|-------|---------|------|----------------|
| 84020 | 7 x 6,5 | 26,5 | |
| 84021 | 7 x 6,5 | 26,5 | |



Salat-Löffel
salad spoon
cuchara para ensalada
cuillère à salade



| | cm | → cm |
|-------|-------|------|
| 84035 | 8 x 7 | 24 |



Eierbecher, 4er Set
egg holder, 4 pcs. set
huevera, set de 4
coquetier, set de 4



| | Ø cm | ↑ cm | pcs. |
|-------|------|------|------|
| 83851 | 8 | 3 | 4 |
| 83848 | 8,5 | 2 | 4 |

FINGERFOOD LÖFFEL



Fingerfood Löffel „HALFTONE“

party spoon
cuchara party
cuillère party



| | Ø cm | ↑ cm | VE / unit |
|-------|------|------|-----------|
| 84158 | 5,5 | 7 | 24 |



Fingerfood Löffel „HALFTONE“

party spoon
cuchara party
cuillère party



| | cm | ↑ cm | VE / unit |
|-------|------------|------|-----------|
| 84128 | 14,5 x 4,5 | 4,5 | 12 |



Fingerfood-Löffel „LEAF“

party spoon
cuchara party
cuillère party



| | cm | ↑ cm | Farbe / Colour | VE / unit |
|-------|----------|------|----------------|-----------|
| 83889 | 10 x 4,5 | 1,5 | | 50 |
| 83887 | 10 x 4,5 | 1,5 | | 50 |
| 83888 | 10 x 4,5 | 1,5 | | 50 |



PARTY SPOON



Fingerfood Löffel „HONG KONG“

party spoon
cuchara party
cuillère party



MAX
70°C



| | cm | ↑ cm | Farbe / Colour | VE / unit |
|-------|----------|------|----------------|-----------|
| 83486 | 13 x 4,5 | 4,5 | | 60 |
| 83487 | 13 x 4,5 | 4,5 | | 60 |
| 83424 | 13 x 4,5 | 4,5 | | 60 |
| 83426 | 13 x 4,5 | 4,5 | | 60 |



Fingerfood-Löffel „MING HING“

party spoon
cuchara party
cuillère party



MAX
70°C



| | cm | ↑ cm | Farbe / Colour | VE / unit |
|-------|----------|------|----------------|-----------|
| 83842 | 11 x 4,5 | 4 | | 60 |
| 83843 | 11 x 4,5 | 4 | | 60 |



Schale „MINI“

bowl
cuenco
bol



MAX
70°C



| | cm | ↑ cm | ltr. | VE / unit |
|-------|----------|------|------|-----------|
| 84460 | 35 x 4,5 | 3 | 0,20 | 10 |



Schale, rund „TAO“

bowl, round
cuenco, redondo
bol, rond



MAX
70°C



| | cm | ↑ cm | ltr. | Farbe / Colour |
|-------|-------------|-----------|------|----------------|
| 83648 | 10,5 x 10,0 | 6,5 / 3,0 | 0,07 | |
| 83649 | 10,5 x 10,0 | 6,5 / 3,0 | 0,07 | |



Schale „MINI“
bowl
cuenco
bol



| | cm | ↑ cm | ltr. | Farbe / Colour | VE / unit |
|-------|-------|------|------|----------------|-----------|
| 84750 | 8 x 8 | 3 | 0,06 | | 24 |



Dipschälchen „APART“
dip bowl
cuenco para dip
ramequin



| | Ø cm | ↑ cm | ltr. | Farbe / Colour |
|-------|------|------|-------|----------------|
| 83800 | 6,5 | 3,0 | 0,045 | |



Dipschälchen „APART“
dip bowl
cuenco para dip
ramequin



| | cm | ↑ cm | ltr. | Farbe / Colour |
|-------|-----------|------|------|----------------|
| 83808 | 6,5 x 6,5 | 3,0 | 0,05 | |



Dipschälchen „FLOWER POT“
dip bowl
cuenco para dip
ramequin

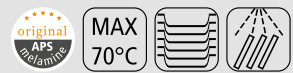

| | Ø cm | ↑ cm | ltr. | Farbe / Colour |
|-------|------|------|------|----------------|
| 84470 | 6 | 3,5 | 0,04 | |
| 84471 | 6 | 3,5 | 0,04 | |
| 84472 | 6 | 3,5 | 0,04 | |



Dipschälchen, 6er Set
dip bowl, 6 pcs.
cuenco para dip, set de 6
ramequin, set de 6

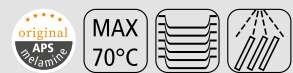

| | Ø cm | ↑ cm | ltr. | Farbe / Colour | pcs. |
|-------|------|------|------|----------------|------|
| 85240 | 6 | 4 | 0,04 | | 6 |
| 85241 | 6 | 4 | 0,04 | | 6 |
| 85242 | 6 | 4 | 0,04 | | 6 |
| 85243 | 6 | 4 | 0,04 | | 6 |
| 85244 | 6 | 4 | 0,04 | | 6 |



Teller „MINI“

plate
plato
assiette



| | cm | ↑ cm | ltr. | VE / unit |
|-------|------------|------|------|-----------|
| 84444 | 10,5 x 8,5 | 2,0 | 0,07 | 20 |

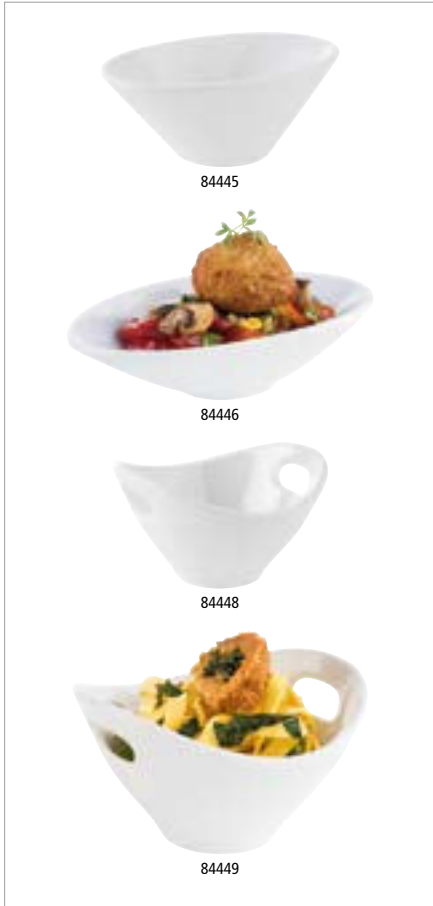

Schale „MINI“

bowl
cuenco
bol



| | cm | ↑ cm | ltr. | VE / unit |
|-------|-------------|------|------|-----------|
| 84445 | 10,5 x 6,0 | 4,0 | 0,07 | 20 |
| 84446 | 13,5 x 7,5 | 3,0 | 0,07 | 20 |
| 84448 | 9,5 x 9,0 | 5,5 | 0,09 | 20 |
| 84449 | 13,0 x 12,0 | 7,5 | 0,18 | 20 |



Schale „MINI“

bowl
cuenco
bol



| | cm | ↑ cm | ltr. | VE / unit |
|-------|------------|------|------|-----------|
| 84452 | 11,5 x 7,5 | 3,0 | 0,06 | 24 |
| 84454 | 11,5 x 6,0 | 5,5 | 0,04 | 24 |
| 84456 | 8,5 x 7,0 | 6,0 | 0,07 | 24 |
| 84458 | 8,0 x 8,0 | 4,0 | 0,10 | 24 |
| 84450 | 7,5 x 7,0 | 4,5 | 0,05 | 24 |



Schale „MINI“
bowl
cuenco
bol



| | Ø cm | ↑ cm | ltr. | Farbe / Colour |
|-------|------|------|------|----------------|
| 84775 | 8,5 | 2,5 | 0,07 | White |
| 84778 | 8,5 | 2,5 | 0,07 | Black |
| 84781 | 8,5 | 2,5 | 0,07 | Grey |



Schale „MINI“
bowl
cuenco
bol



| | Ø cm | ↑ cm | ltr. | Farbe / Colour |
|-------|------|------|------|----------------|
| 84776 | 8,5 | 2,5 | 0,07 | White |
| 84779 | 8,5 | 2,5 | 0,07 | Black |
| 84782 | 8,5 | 2,5 | 0,07 | Grey |



Schale „MINI“
bowl
cuenco
bol



| | cm | ↑ cm | ltr. | Farbe / Colour |
|-------|-----------|------|------|----------------|
| 84777 | 9,5 x 5,5 | 5,5 | 0,07 | White |
| 84780 | 9,5 x 5,5 | 5,5 | 0,07 | Black |
| 84783 | 9,5 x 5,5 | 5,5 | 0,07 | Grey |



Schale „HALFTONE“
bowl
cuenco
bol



| | Ø cm | ↑ cm | ltr. | VE / unit |
|-------|------|------|------|-----------|
| 84217 | 8,0 | 4,0 | 0,1 | 12 |



Dipschälchen „GOURMET“
dip bowl
cuenco para dip
ramequin

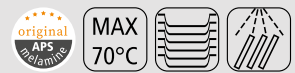

| | Ø cm | ↑ cm | ltr. |
|-------|------|------|------|
| 84018 | 7 | 6 | 0,05 |

GN CONTAINERS

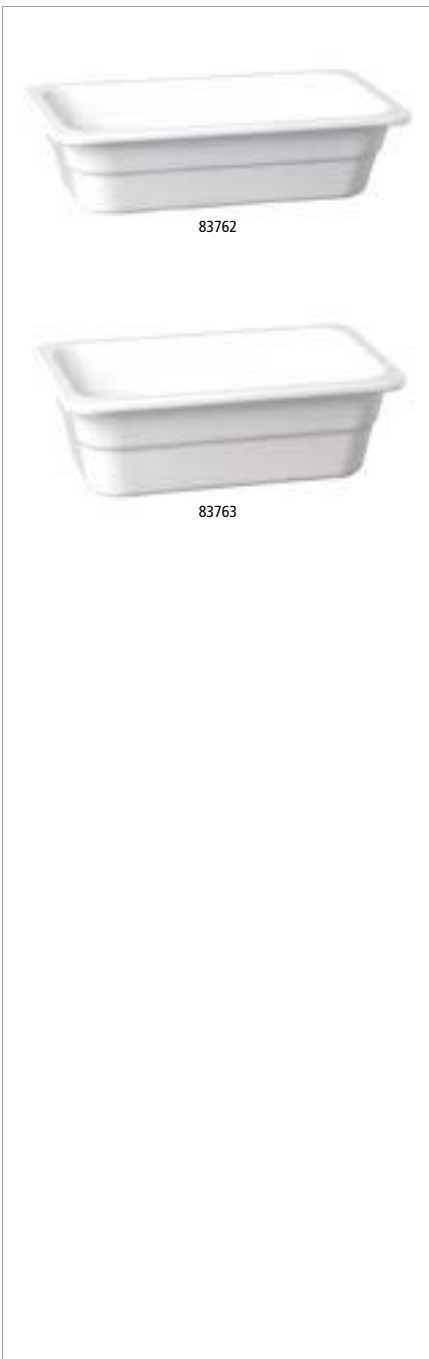

GN-Behälter „HIGHLINE“

GN container
GN cubeta
GN bac



extrem bruchsicher, glänzende und harte Oberfläche, tiefkühlfest, keinen Temperaturschocks unterziehen, nicht auf heißen Flächen liegen lassen, mit Stapelnocke

durable, top quality, hard and glossy surface, avoid thermal shocks, do not leave on hot surfaces, with notching edge

duradera, alta calidad, superficie brillante y resistente, hay que evitar los cambios térmicos bruscos, no apoyar en superficies calientes, con borde para apilamiento

durable, haute qualité, surface brillante et résistante, éviter les chocs thermiques et ne pas poser sur une surface chaude, encoche pour une louche

| | GN | ↓ mm | ltr. | cm |
|-------|-----|------|------|-------------|
| 83772 | 1/1 | 65 | 7,10 | 53,0 x 32,5 |
| 83768 | 1/2 | 65 | 3,40 | 32,5 x 26,5 |
| 83766 | 2/4 | 65 | 3,00 | 53,0 x 16,2 |
| 83764 | 1/3 | 65 | 2,00 | 32,5 x 17,6 |
| 83762 | 1/4 | 65 | 1,35 | 26,5 x 16,2 |
| 83760 | 1/6 | 65 | 0,80 | 17,6 x 16,2 |

| | GN | ↓ mm | ltr. | cm |
|-------|-----|------|------|-------------|
| 83773 | 1/1 | 100 | 11,0 | 53,0 x 32,5 |
| 83769 | 1/2 | 100 | 5,50 | 32,5 x 26,5 |
| 83765 | 1/3 | 100 | 3,15 | 32,5 x 17,6 |
| 83763 | 1/4 | 100 | 2,20 | 26,5 x 16,2 |
| 83761 | 1/6 | 100 | 1,25 | 17,6 x 16,2 |



83768

stapelbar
stackable



GN-Behälter „ECOLINE“

GN container

GN cubeta

GN bac

mit Stapelnocke

with notching edge

con borde marcado para el apilado

avec rebord pour l'empilage



| | GN | ↓ mm | ltr. | cm | Farbe / Colour |
|-------|-----|------|------|-------------|----------------|
| 83759 | 1/1 | 65 | 7,10 | 53,0 x 32,5 | |
| 83755 | 2/4 | 65 | 3,00 | 53,0 x 16,2 | |
| 83757 | 1/2 | 65 | 3,40 | 32,5 x 26,5 | |
| 83753 | 1/3 | 65 | 2,00 | 32,5 x 17,6 | |
| 83751 | 1/4 | 65 | 1,35 | 26,5 x 16,2 | |
| 83749 | 1/6 | 65 | 0,80 | 17,6 x 16,2 | |

| | GN | ↓ mm | ltr. | cm | Farbe / Colour |
|-------|-----|------|------|-------------|----------------|
| 83758 | 1/1 | 65 | 7,10 | 53,0 x 32,5 | |
| 83754 | 2/4 | 65 | 3,00 | 53,0 x 16,2 | |
| 83756 | 1/2 | 65 | 3,40 | 32,5 x 26,5 | |
| 83752 | 1/3 | 65 | 2,00 | 32,5 x 17,6 | |
| 83750 | 1/4 | 65 | 1,35 | 26,5 x 16,2 | |
| 83748 | 1/6 | 65 | 0,80 | 17,6 x 16,2 | |

| | GN | ↓ mm | ltr. | cm | Farbe / Colour |
|-------|-----|------|------|-------------|----------------|
| 84300 | 1/1 | 100 | 10,6 | 53,0 x 32,5 | |
| 84302 | 2/4 | 100 | 4,3 | 53,0 x 16,2 | |
| 84301 | 1/2 | 100 | 4,7 | 32,5 x 26,5 | |
| 84303 | 1/3 | 100 | 2,7 | 32,5 x 17,6 | |
| 84304 | 1/4 | 100 | 1,9 | 26,5 x 16,2 | |
| 84305 | 1/6 | 100 | 1,0 | 17,6 x 16,2 | |

| | GN | ↓ mm | ltr. | cm | Farbe / Colour |
|-------|-----|------|------|-------------|----------------|
| 84306 | 1/1 | 100 | 10,6 | 53,0 x 32,5 | |
| 84308 | 2/4 | 100 | 4,3 | 53,0 x 16,2 | |
| 84307 | 1/2 | 100 | 4,7 | 32,5 x 26,5 | |
| 84309 | 1/3 | 100 | 2,7 | 32,5 x 17,6 | |
| 84310 | 1/4 | 100 | 1,9 | 26,5 x 16,2 | |
| 84311 | 1/6 | 100 | 1,0 | 17,6 x 16,2 | |



GN-Deckel

GN-lid

GN tapa

GN couvercle



| | GN | cm |
|-------|-----|-------------|
| 82001 | 1/1 | 53,0 x 32,5 |
| 82013 | 1/2 | 32,5 x 26,5 |
| 82019 | 1/3 | 32,5 x 17,6 |
| 82029 | 1/4 | 26,5 x 16,2 |
| 82037 | 1/6 | 17,6 x 16,2 |





Tableware

Table Presentation

| | |
|-------------------------------------|-----|
| LEVANTE | 228 |
| SERVING TROWELS..... | 230 |
| CAST IRON..... | 231 |
| SERVING POTS..... | 232 |
| SNACKHOLDERS | 234 |
| DIP BOWLS | 238 |
| PARTY SPOONS | 240 |
| BOWLS WOOD | 241 |
| SERVING BOARDS WOOD | 243 |
| SERVING BOARDS NATURAL SLATE.... | 249 |
| TRAYS BOARDS..... | 251 |
| SALT- / PEPPER MILLS | 252 |
| MENAGES | 259 |
| SUGAR DISPENSERS | 267 |
| BUTTER DISHES EGG HOLDERS | 270 |
| FONDUE CAVIAR COOLER SKEWER.... | 271 |
| TABLE CADDYS | 272 |
| CANDLE HOLDERS | 274 |
| FLOWER VASES..... | 275 |
| PLACEMATS..... | 276 |
| ENAMELWARE | 279 |
| GLASSES | 281 |
| SEAFOOD..... | 287 |
| CAKE STANDS | 288 |
| SUPER DOME..... | 290 |
| GRAVY BOATS..... | 291 |
| PLATE TRAYS | 292 |
| COASTERS..... | 293 |
| CUTLERY BINS WASTE BINS..... | 294 |
| MENU HOLDERS..... | 297 |
| TO GO CUP | 305 |

LEVANTE



Levante Küche passend serviert! Viel Gemüse, wenig Fleisch und eine Vielfalt an Gewürzen charakterisieren die Küche des Nahen Ostens. Der östliche Mittelmeerraum, also Syrien, Libanon, Jordanien, Israel und Palästina wird als Levante bezeichnet. Als Levante-Küche wird die Essenstradition dieser Länder als Food-Trend gefeiert.

Levantine cuisine served appropriately! Lots of vegetables, little meat and a variety of spices characterise the cuisine of the Middle East. The eastern Mediterranean region, i. e. Syria, Lebanon, Jordan, Israel and Palestine is referred to as the Levant. As Levantine cuisine, the food tradition of these countries is celebrated as a food trend.

Cocina levantina servida como es debido. Mucha verdura, poca carne y una gran variedad de especias caracterizan la cocina de Oriente Medio. La región del Mediterráneo oriental, es decir, Siria, Líbano, Jordania, Israel y Palestina, se denomina Levante. La cocina levantina, la tradición alimentaria de estos países, se celebra como una tendencia alimentaria.

Cuisine levantine servie comme il se doit! Beaucoup de légumes, peu de viande et une variété d'épices caractérisent la cuisine du Moyen-Orient. La région de la Méditerranée orientale, c'est-à-dire la Syrie, le Liban, la Jordanie, Israël et la Palestine, est appelée le Levant. La tradition alimentaire de ces pays, la cuisine levantine, est célébrée comme une tendance alimentaire.



Flaschenkühler „LEVANTE“

bottle cooler
enfriador de botella
rafraîchisseur de bouteille



doppelwandig für beste Isolierung, für 0,7 - 1,5 Liter-Flaschen

double wall cooler keeps the temperature for a long time, for 0,7 - 1,5 ltr. bottles

doble pared para mantener el frío largo tiempo, para botellas de 0,7 - 1,5 ltr.

double paroi pour une meilleure conservation de la température, pour bouteilles de 0,7 à 1,5 l.

| | cm | ↑ cm | Farbe / Colour |
|-------|---------|------|----------------|
| 36125 | 12 / 10 | 20 | |
| 36127 | 12 / 10 | 20 | |



Tablett „LEVANTE“

tray
bandeja
GN plateau



| | cm | ↑ cm | ltr. | Farbe / Colour |
|-------|-----------|------|------|----------------|
| 40712 | 26,5 x 16 | 3 | 0,70 | |
| 40713 | 26,5 x 16 | 3 | 0,70 | |



Präsentationsmöglichkeit
presentation example



Schale „LEVANTE“

bowl
cuenco
bol



| | Ø cm | ↑ cm | ltr. | Farbe / Colour |
|-------|------|------|------|----------------|
| 40700 | 9,5 | 4,5 | 0,14 | |
| 40701 | 9,5 | 4,5 | 0,14 | |
| 40702 | 12 | 6,5 | 0,32 | |
| 40703 | 12 | 6,5 | 0,32 | |
| 40704 | 17 | 8,5 | 0,90 | |
| 40705 | 17 | 8,5 | 0,90 | |



stapelbar
stackable



Schale „LEVANTE“

bowl
cuenco
bol



| | Ø cm | ↑ cm | ltr. | Farbe / Colour |
|-------|------|------|------|----------------|
| 40706 | 7,5 | 2,5 | 0,05 | |
| 40707 | 7,5 | 2,5 | 0,05 | |
| 40708 | 8,5 | 5,5 | 0,20 | |
| 40709 | 8,5 | 5,5 | 0,20 | |
| 40710 | 8,5 | 8,5 | 0,40 | |
| 40711 | 8,5 | 8,5 | 0,40 | |

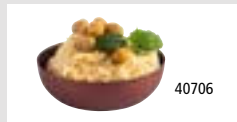

40706

Präsentationsmöglichkeit
presentation example

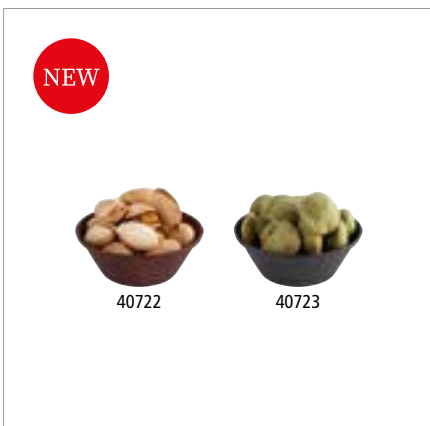

Dipschälchen, 6er Set „LEVANTE“

dip bowl, 6 pcs.
cuenco para dip, set de 6
ramequin, set de 6



| | Ø cm | ↑ cm | ltr. | Farbe / Colour | pcs. |
|-------|------|------|------|----------------|------|
| 40722 | 6,0 | 2,5 | 0,04 | | 6 |
| 40723 | 6,0 | 2,5 | 0,04 | | 6 |



40723

00754

Präsentationsmöglichkeit
presentation example



Dipschälchen, 6er Set „LEVANTE“

dip bowl, 6 pcs.
cuenco para dip, set de 6
ramequin, set de 6



| | Ø cm | ↑ cm | ltr. | Farbe / Colour | pcs. |
|-------|------|------|------|----------------|------|
| 40726 | 6,0 | 4,5 | 0,06 | | 6 |
| 40727 | 6,0 | 4,5 | 0,06 | | 6 |

SERVING TROWEL *super trendy*



Servierkelle „BOB“

serving trowel
paleta para servir
truelle de service



Edelstahl Servierkelle mit schwarzem Holzgriff

stainless steel serving trowel with black wooden handle
paleta para servir de acero inoxidable con mango de madera negra
truelle de service en acier inox avec manche en bois noir

| | cm | ↑ cm | Griff / handle cm | |
|-------|-------------|------|-------------------|-----------------|
| 40680 | 23,5 x 15,5 | 12,5 | 13,5 | stainless steel |
| 40681 | 23,5 x 15,5 | 12,5 | 13,5 | ■ |

Snackbox „INDUSTRIAL“

snack box
caja tentempié
casse-croûte



Metall, schwarz

metal, black
metal, negro
métal, noir

| | cm | ↑ cm | ltr. |
|-------|-------------|------|------|
| 40676 | 23,0 x 15,5 | 13,0 | 2,4 |



stapelbar
stackable

CAST IRON



Die Servierpfännchen aus emailiertem Gusseisen dienen dem portionsweisen Servieren und halten die Speisen warm.

The serving pans made of enameled cast iron are used for serving in portions and for keeping the food warm.

Las fuentes de hierro fundido esmaltado se utilizan para servir en porciones y mantener la comida caliente.

Les plateaux de service en fonte émaillée sont utilisés pour servir en portions et garder les aliments au chaud.



Servierpfännchen „CAST IRON“

serving pan
fuente para servir
plat de service

Gusseisen emailiert
enameled cast iron
hierro fundido esmaltado
fonte émaillée



| | Ø cm | ↑ cm | Farbe / Colour |
|-------|------|------|----------------|
| 88220 | 10 | 2 | Grey |
| 88225 | 10 | 2 | Blue |
| 88221 | 13 | 2 | Grey |
| 88226 | 13 | 2 | Blue |



Servierpfännchen „CAST IRON“

serving pan
fuente para servir
plat de service

Gusseisen emailiert
enameled cast iron
hierro fundido esmaltado
fonte émaillée



| | cm | ↑ cm | Farbe / Colour |
|-------|---------|------|----------------|
| 88222 | 13 x 13 | 2 | Grey |
| 88227 | 13 x 13 | 2 | Blue |
| 88223 | 16 x 13 | 2 | Grey |
| 88228 | 16 x 13 | 2 | Blue |
| 88224 | 20 x 13 | 2 | Grey |
| 88229 | 20 x 13 | 2 | Blue |





NEW

MUMBAI

NEW



40730 0,30 ltr.



40731 0,35 ltr.



40732 0,60 ltr.

Serviertöpfchen „MUMBAI“

small serving pot
olla pequeña de servir
marmite petite de servir



Edelstahl, außen: Kupfer-Look, gehämmerte Oberfläche, Griffe vergoldet
stainless steel, outside: copper look, hammered surface, handles gold-plated
acero inoxidable, exterior: look cobre, superficie martillada, asas doradas
acier inox, extérieur: look cuivre, surface martelée, poignées dorées

| | Ø cm | ↑ cm | ltr. | Griff / handle cm |
|-------|------|------|------|-------------------|
| 40730 | 9,0 | 5,5 | 0,30 | 2,25 |
| 40731 | 11,5 | 4,5 | 0,35 | 2,00 |
| 40732 | 11,5 | 7,0 | 0,60 | 2,25 |
| 40733 | 14,0 | 5,0 | 0,50 | 1,75 |
| 40734 | 16,0 | 5,0 | 0,70 | 1,75 |

NEW



40735 0,25 ltr.



40736 0,45 ltr.

Mini-Servierpfanne „MUMBAI“

small serving pan
olla pequeña de servir
marmite petite de servir



Edelstahl, außen: Kupfer-Look, gehämmerte Oberfläche, Griffe vergoldet
stainless steel, outside: copper look, hammered surface, handles gold-plated
acero inoxidable, exterior: look cobre, superficie martillada, asas doradas
acier inox, extérieur: look cuivre, surface martelée, poignées dorées

| | cm | ↑ cm | ltr. | Griff / handle cm |
|-------|------------|------|------|-------------------|
| 40735 | 12,5 x 8,5 | 4,0 | 0,25 | 2,0 |
| 40736 | 14,5 x 9,5 | 4,5 | 0,45 | 2,0 |

NEW



40737 0,15 ltr.



40738 0,20 ltr.

Schale „MUMBAI“

bowl
cuenco
bol



Edelstahl, außen: Kupfer-Look, gehämmerte Oberfläche, Griffe vergoldet
stainless steel, outside: copper look, hammered surface, handles gold-plated
acero inoxidable, exterior: look cobre, superficie martillada, asas doradas
acier inox, extérieur: look cuivre, surface martelée, poignées dorées

| | Ø cm | ↑ cm | ltr. |
|-------|------|------|------|
| 40737 | 8,5 | 4,5 | 0,15 |
| 40738 | 9,0 | 5,0 | 0,20 |

NEW



40740 0,6 ltr.



40741 0,3 ltr.



40742 0,5 ltr.

Serviertöpfchen

small serving pot
olla pequeña de servir
marmite petite de servir

Aluminium anthrazit, Griffe aus Messing

aluminium anthracite, brass handles

aluminio antracita, asas de latón

aluminium anthracite, poignées en laiton



| | Ø cm | ↑ cm | ltr. | Griff / handle cm |
|-------|------|------|------|-------------------|
| 40740 | 11,5 | 9,5 | 0,6 | 2,5 |
| 40741 | 13,5 | 5,0 | 0,3 | 3,5 |
| 40742 | 15,0 | 6,0 | 0,5 | 2,5 |

**Mini-Servierpfanne „SNACKHOLDER“**

mini pan
sartén en formato mini
poêle à frire mini



| | cm | ↑ cm | ltr. |
|-------|------------|-----------|------|
| 40660 | 14,5 x 9,5 | 4,5 / 6,5 | 0,5 |



40186 0,30 ltr.



40187 0,55 ltr.



40188 0,75 ltr.

Serviertöpfchen „MUMBAI“

small serving pot
olla pequeña de servir
marmite petite de servir

gehämmerte Oberfläche

hammered surface

superficie martillada

surface martelée



| | Ø cm | ↑ cm | ltr. | Griff / handle cm |
|-------|------|------|------|-------------------|
| 40186 | 9,5 | 5,5 | 0,30 | 2,5 |
| 40187 | 13,5 | 5,0 | 0,55 | 3,0 |
| 40188 | 15,5 | 5,0 | 0,75 | 3,0 |



40642 0,05 ltr.



40643 0,12 ltr.



40644 0,32 ltr.

Stielkasserolle / Serviertopf

sauté pan / mini sauce pan
cazo recto bajo
plat à sauter

hochglanzpoliert

mirror polished

pulido brillante

poli brillant



| | Ø cm | ↑ cm | ltr. | Griff / handle cm |
|-------|------|------|------|-------------------|
| 40642 | 5,5 | 2,5 | 0,05 | 6 |
| 40643 | 7,0 | 3,5 | 0,12 | 8,5 |
| 40644 | 9,5 | 5,5 | 0,32 | 8,5 |

SNACKHOLDER



Die Mini-Edelstahlkörbchen dienen dem portionsweisen Servieren. Zum originellen Servieren von Beilagen geeignet, aber auch zum Frittieren selbst.

The mini frying baskets are used to present individual portions in an original way, but can still be used to fry.

Las mini cestas para freír se utilizan para presentar las porciones individuales de forma original, pero pueden seguir utilizándose para freír.

Les paniers à friture offrent une présentation originale pour servir apéritifs, snacks, tapas et autres rations individuelles. Également aptes pour frire.



Servier-Frittierkorb „SNACKHOLDER“ stainless steel fry baskets cestitas inox para el servicio mesa paniers inox pour le service sur table



| | Ø cm | ↑ cm | Griff / handle cm | Farbe / Colour | |
|--------------------------|------|------|-------------------|----------------|-----------------|
| 40600 | 8 | 7,5 | 9,5 | | stainless steel |
| 40602 | 8 | 7,5 | 9,5 | | gold |
| 40624 <small>NEW</small> | 8 | 7,5 | 9,5 | | black mat |
| 40601 | 9 | 8,5 | 9,0 | | stainless steel |
| 40603 | 9 | 8,5 | 9,0 | | gold |
| 40625 <small>NEW</small> | 9 | 8,5 | 9,0 | | black mat |



Servier-Frittierkorb „SNACKHOLDER“ stainless steel fry baskets cestitas inox para el servicio mesa paniers inox pour le service sur table



| | cm | ↑ cm | Griff / handle cm | Farbe / Colour | |
|--------------------------|-------------|------|-------------------|----------------|-----------------|
| 40610 | 21,5 x 10,5 | 4,5 | 9,5 | | stainless steel |
| 40612 | 21,5 x 10,5 | 4,5 | 9,5 | | gold |
| 40628 <small>NEW</small> | 21,5 x 10,5 | 4,5 | 9,5 | | black mat |
| 40611 | 26,0 x 13,0 | 5,0 | 9,0 | | stainless steel |
| 40613 | 26,0 x 13,0 | 5,0 | 9,0 | | gold |
| 40629 <small>NEW</small> | 26,0 x 13,0 | 5,0 | 9,0 | | black mat |



Servier-Frittierkorb „SNACKHOLDER“ stainless steel fry baskets cestitas inox para el servicio mesa paniers inox pour le service sur table



| | cm | ↑ cm | Griff / handle cm | Farbe / Colour | |
|--------------------------|-------------|------|-------------------|----------------|-----------------|
| 40620 | 10,0 x 8,5 | 6,5 | 9,0 | | stainless steel |
| 40622 | 10,0 x 8,5 | 6,5 | 9,0 | | gold |
| 40626 <small>NEW</small> | 10,0 x 8,5 | 6,5 | 9,0 | | black mat |
| 40621 | 13,0 x 10,5 | 9,0 | 13,5 | | stainless steel |
| 40623 | 13,0 x 10,5 | 9,0 | 13,5 | | gold |
| 40627 <small>NEW</small> | 13,0 x 10,5 | 9,0 | 13,5 | | black mat |



Snackholder
serving cup
vaso para servir
gobelet à apéritif



| | Ø cm | ↑ cm | ltr. | Farbe / Colour |
|-------|------|------------|------|------------------|
| 40606 | 8,5 | 8,5 | 0,35 | stainless steel |
| 40617 | 8,5 | 8,5 | 0,35 | stainless copper |
| 40607 | 8,5 | 8,5 | 0,35 | hammered surface |
| 40618 | 8,5 | 8,5 | 0,35 | hammered surface |
| 40605 | 9,5 | 8,5 / 11,5 | 0,45 | stainless steel |
| 40616 | 9,5 | 8,5 / 11,5 | 0,45 | stainless copper |



Schale „LEVANTE“
bowl
cuenco
bol



| | Ø cm | ↑ cm | ltr. | Farbe / Colour |
|-------|------|------|------|----------------|
| 40710 | 8,5 | 8,5 | 0,40 | reddish-brown |
| 40711 | 8,5 | 8,5 | 0,40 | dark grey |



Servier- / Saucen-Eimer „SNACKHOLDER“

mini stainless steel bucket
cubo inox en formato mini
seau mini inox
hochglanzpoliert
mirror polished
pulido brillante
poli brillant



| | Ø cm | ↑ cm | ltr. | pcs. |
|-------|------|------|------|------|
| 40630 | 7 | 6,5 | 0,15 | 4 |
| 40631 | 9 | 8,5 | 0,33 | 1 |



Mini-Milchkanne „SNACKHOLDER“ 4er Set

mini milk can, 4 pcs.
lechera en formato mini, set de 4
pot à lait mini, set de 4



| | Ø cm | ↑ cm | ltr. | pcs. |
|-------|------|------|------|------|
| 40640 | 4,5 | 5 | 0,08 | 4 |

SNACKHOLDERS



Snackcan

serving can
lata para aperitivos
boîte de conserves pour apéritifs

matt poliert
matt polished
pulido mate
poli mat



| | Ø cm | ↑ cm | ltr. | |
|-------|------|------|------|-----------------------|
| 40654 | 6,5 | 4,0 | 0,12 | ideale Beilagen Größe |
| 40655 | 7,5 | 5,5 | 0,17 | |
| 40656 | 7,5 | 10,0 | 0,35 | |
| 40659 | 12,0 | 8,0 | 0,80 | |
| 40658 | 13,5 | 14,0 | 1,80 | |
| 40657 | 13,5 | 10,5 | 1,30 | |

Wachspapier „SNACKHOLDER“ / greaseproof paper squares
papel alimenticio para cucurucho / papier alimentaire pour cornet

| | cm | pcs. | |
|-------|---------|------|----------------|
| 40670 | 42 x 25 | 500 | Motiv: Zeitung |



Präsentationsmöglichkeit
presentation example



Schale

bowl
cuenco
bol
hochglanzpoliert
mirror polished
pulido brillante
poli brillant



| | Ø cm | ↑ cm | ltr. |
|-------|------|------|------|
| 40685 | 6 | 3,0 | 0,05 |
| 40686 | 8 | 4,5 | 0,17 |



Schale "MUMBAI"

bowl
cuenco
bol
gehämmerte Oberfläche
hammered surface
superficie martillada
surface martelée



| | Ø cm | ↑ cm | ltr. |
|-------|------|------|------|
| 40185 | 9,5 | 3 | 0,15 |



40690 0,7 ltr.



40691 0,7 ltr.



40692 0,7 ltr.



40693 1,4 ltr.



40694 1,4 ltr.



40695 1,4 ltr.

Schale
bowl
cuenco
bol

gehämmerte Oberfläche
hammered surface
superficie martillada
surface martelée



| | Ø cm | ↑ cm | ltr. | Farbe / Colour | |
|-------|-------------|------|------|----------------|---------------|
| 40690 | 15,5 x 12,0 | 5,5 | 0,7 | | gold look |
| 40691 | 15,5 x 12,0 | 5,5 | 0,7 | | copper look |
| 40692 | 15,5 x 12,0 | 5,5 | 0,7 | | gunmetal-look |
| 40693 | 23,0 x 15,5 | 6,0 | 1,4 | | gold look |
| 40694 | 23,0 x 15,5 | 6,0 | 1,4 | | copper look |
| 40695 | 23,0 x 15,5 | 6,0 | 1,4 | | gunmetal-look |



Präsentationsmöglichkeit
presentation example



40604

Servierkorb „BURGER & FRIES“

serving basket
cesta para servir
corbeille de service

Servierkorb aus Metall mit 2 Haltern für Dipschälchen

metal serving basket with 2 holders for dip bowls
cesta de metal para servir con 2 soportes para cuencos para dip
corbeille de service en métal avec 2 supports pour ramequins



| | cm | ↑ cm |
|-------|-----------|------|
| 40604 | 39,5 x 20 | 11 |

passende Schälchen / suitable bowls / cuencos adecuados / bols
appropriés



| | Ø cm | ↑ cm | ltr. | VE / unit |
|-------|------|------|------|-----------|
| 83781 | 7,5 | 4 | 0,07 | 24 |



83781

Servierbeispiel - Lieferung ohne Schälchen
delivery without bowls



Präsentationsmöglichkeit
presentation example

DIP BOWLS



Ob Nachos mit Käsedip, Gemüsesticks mit Joghurtsoße oder eine Käseplatte mit Feigenenf: All diese Köstlichkeiten finden in Dipschalen ihren Platz und regen den Appetit Ihrer Gäste an.

Whether nachos with cheese dip, vegetable sticks with yoghurt sauce or cheese platter with fig mustard: all these delicacies find their place in dip bowls and stimulate the appetite of your guests.

Ya sean nachos con dip de queso, palitos de verdura con salsa de yogur o tabla de quesos con mostaza de higos: todas estas delicias encuentran su lugar en los cuencos para dip y estimulan el apetito de sus invitados.

Qu'il s'agisse de nachos avec trempette au fromage, de bâtonnets de légumes avec sauce au yaourt ou d'un plateau de fromage avec moutarde aux figues : tous ces délices trouvent leur place dans les bols à trempette et stimulent l'appétit de vos invités.



NEW



Dipschälchen, 6er Set dip bowl, 6 pcs. cuenco para dip, set de 6 ramequin, set de 6



| | Ø cm | ↑ cm | ltr. | Farbe / Colour | pcs. |
|-------|------|------|------|----------------|------|
| 40720 | 6,0 | 2,5 | 0,04 | | 6 |
| 40721 | 6,0 | 2,5 | 0,04 | | 6 |
| 40722 | 6,0 | 2,5 | 0,04 | | 6 |
| 40723 | 6,0 | 2,5 | 0,04 | | 6 |
| 40728 | 6,0 | 2,5 | 0,04 | | 6 |

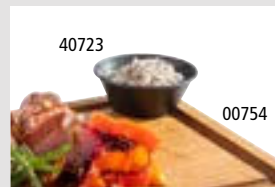

Präsentationsmöglichkeit
presentation example



NEW



Dipschälchen, 6er Set dip bowl, 6 pcs. cuenco para dip, set de 6 ramequin, set de 6



| | Ø cm | ↑ cm | ltr. | Farbe / Colour | pcs. |
|-------|------|------|------|----------------|------|
| 40724 | 6,0 | 4,5 | 0,06 | | 6 |
| 40725 | 6,0 | 4,5 | 0,06 | | 6 |
| 40726 | 6,0 | 4,5 | 0,06 | | 6 |
| 40727 | 6,0 | 4,5 | 0,06 | | 6 |
| 40729 | 6,0 | 4,5 | 0,06 | | 6 |



Dipschälchen, 12er Set
dip bowl, 12 pcs.
cuenco para dip, set de 12
ramequin, set de 12



| | Ø cm | ↑ cm | ltr. | Farbe / Colour | pcs. |
|-------|------|------|------|----------------|------|
| 40760 | 6,0 | 3,5 | 0,04 | — | 12 |
| 40761 | 6,0 | 3,5 | 0,04 | — | 12 |
| 40762 | 6,0 | 3,5 | 0,04 | — | 12 |
| 40763 | 7,0 | 3,5 | 0,07 | — | 12 |
| 40764 | 7,0 | 3,5 | 0,07 | — | 12 |
| 40765 | 7,0 | 3,5 | 0,07 | — | 12 |
| 40766 | 7,5 | 4,0 | 0,09 | — | 12 |
| 40767 | 7,5 | 4,0 | 0,09 | — | 12 |
| 40768 | 7,5 | 4,0 | 0,09 | — | 12 |



Dipschälchen, 6er Set
dip bowl, 6 pcs.
cuenco para dip, set de 6
ramequin, set de 6



| | Ø cm | ↑ cm | ltr. | Farbe / Colour | pcs. |
|-------|------|------|------|----------------|------|
| 85240 | 6,0 | 4,0 | 0,04 | — | 6 |
| 85241 | 6,0 | 4,0 | 0,04 | — | 6 |
| 85242 | 6,0 | 4,0 | 0,04 | — | 6 |
| 85243 | 6,0 | 4,0 | 0,04 | — | 6 |
| 85244 | 6,0 | 4,0 | 0,04 | — | 6 |



Dipschälchen „FLOWER POT“
dip bowl
cuenco para dip
ramequin



| | Ø cm | ↑ cm | ltr. | Farbe / Colour | VE / unit |
|-------|------|------|------|----------------|-----------|
| 84470 | 6,0 | 3,5 | 0,04 | — | 60 |
| 84471 | 6,0 | 3,5 | 0,04 | — | 60 |
| 84472 | 6,0 | 3,5 | 0,04 | — | 60 |



Dipschälchen „CASUAL“
dip bowl
cuenco para dip
ramequin



| | Ø cm | ↑ cm | ltr. | Farbe / Colour | VE / unit |
|-------|------|------|------|----------------|-----------|
| 83780 | 6,0 | 4,0 | 0,04 | — | 24 |
| 83781 | 7,5 | 4,0 | 0,07 | — | 24 |
| 83782 | 8,0 | 4,5 | 0,08 | — | 24 |
| 83783 | 8,5 | 4,5 | 0,12 | — | 24 |
| 83798 | 6,0 | 4,0 | 0,04 | — | 24 |
| 83777 | 6,0 | 3,5 | 0,03 | — | 24 |



Dipschälchen „GOURMET“
dip bowl
cuenco para dip
ramequin



| | Ø cm | ↑ cm | ltr. | Farbe / Colour | VE / unit |
|-------|------|------|------|----------------|-----------|
| 84018 | 7,0 | 6,0 | 0,05 | — | 20 |

PARTY SPOONS



Gourmetlöffel/-gabel, 6er Set

tapas spoon / fork, 6 pcs.
cuchara / tenedor de tapas, set de 6
cuillère / fourchette à tapas, set de 6

Verwendung als Löffel oder Gabel möglich

can be used as a spoon or fork

puede utilizarse como cuchara o tenedor

peut être utilisé comme une cuillère ou une fourchette



84930

84930

→ cm

pcs.

00699

10

6



Gourmet-Löffel „CLASSIC“

party spoon
cuchara gourmet
cuillère gourmet



→ cm

00693

12,0

gunmetal look

PVD coated stainless steel

00677

13,5

stainless steel look

00691

12,0

gold look

PVD coated stainless steel

00692

12,0

copper look

PVD coated stainless steel

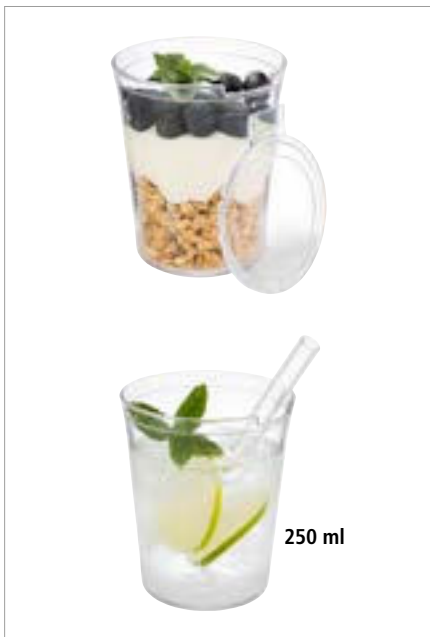

Becher Set „SUPER CUP“, 8er Set

barrel mug set, 8 pcs.
vasos, set de 8
gobelets, set de 8

Set bestehend aus 8 Bechern + 8 Deckeln

set consists of 8 barrel mugs + 8 lids

set compuesto por 8 vasos + 8 tapas

set composé de 8 gobelets + 8 couvercles



**IDEAL
FÜR
„TAKE AWAY“**

Ø cm

↑ cm

ltr.

pcs.

10506

8

10

0,25

8



mit Stapelnocke
with stacking cam



rutschfester Deckel
non-slip lid



Snackspender

snack dispenser
dispensador de snacks
distributeur de snacks

Behälter aus Glas, Schraubdeckel aus Edelstahl, Öffnung oval 3,5 x 2,5 cm

glass container, stainless steel screw cap, opening oval 3,5 x 2,5 cm

recipiente de cristal, tapón de rosca de acero inoxidable, apertura ovalada 3,5 x 2,5 cm

réipient en verre, couvercle à visser en acier inox, ouverture ovale 3,5 x 2,5 cm



Ø cm

↑ cm

ltr.

Farbe / Colour

40516

8,5

15,5

0,35

Gold

40517

8,5

15,5

0,35

Schwarz



Schale, 4er Set „OLIVE“

bowl, 4 pcs.
cuenco, set de 4
bol, set de 4



aus geöltem Olivenholz, naturbedingte Abweichung in Form, Maserung und Größe
oiled olive wood, natural deviation in shape, grain and size
de madera de olivo aceitada, diferencias naturales posibles en forma, grano y tamaño
en bois d'olivier huilé, éventuelles différences naturelles de forme, de grain et de taille

| | Ø cm | ↑ cm | ltr. | pcs. |
|-------|------|------|------|------|
| 01024 | 6 | 2 | 0,03 | 4 |



Schale, 2er Set „OLIVE“

bowl, 2 pcs.
cuenco, set de 4
bol, set de 4



aus geöltem Olivenholz, naturbedingte Abweichung in Form, Maserung und Größe
oiled olive wood, natural deviation in shape, grain and size
de madera de olivo aceitada, diferencias naturales posibles en forma, grano y tamaño
en bois d'olivier huilé, éventuelles différences naturelles de forme, de grain et de taille

| | cm | ↑ cm | ltr. | pcs. |
|-------|----------|------|------|------|
| 01025 | 12,5 x 8 | 2,5 | 0,05 | 2 |

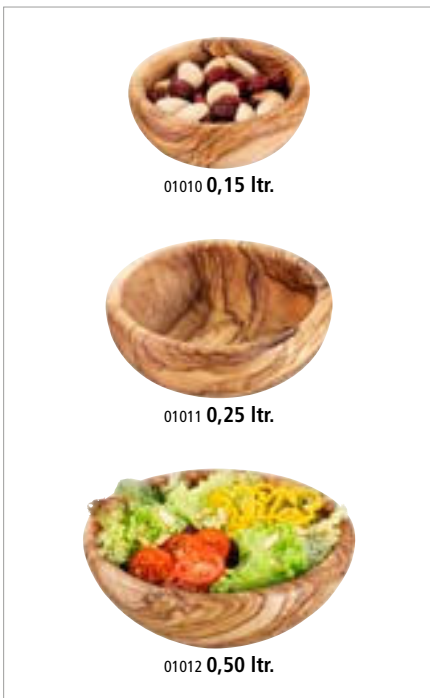

Schale „OLIVE“

bowl
cuenco
bol



aus geöltem Olivenholz, naturbedingte Abweichung in Form, Maserung und Größe
oiled olive wood, natural deviation in shape, grain and size
de madera de olivo aceitada, diferencias naturales posibles en forma, grano y tamaño
en bois d'olivier huilé, éventuelles différences naturelles de forme, de grain et de taille

| | Ø cm | ↑ cm | ltr. |
|-------|------|------|------|
| 01010 | 10,0 | 4,0 | 0,15 |
| 01011 | 12,5 | 4,5 | 0,25 |
| 01012 | 15,0 | 6,0 | 0,50 |



3 Größen ineinander
3 sizes in each other



Schale „OLIVE“

bowl
cuenco
bol



aus geöltem Olivenholz, naturbedingte Abweichung in Form, Maserung und Größe
oiled olive wood, natural deviation in shape, grain and size
de madera de olivo aceitada, diferencias naturales posibles en forma, grano y tamaño
en bois d'olivier huilé, éventuelles différences naturelles de forme, de grain et de taille

| | cm | ↑ cm | ltr. |
|-------|------------|------|------|
| 00843 | 12,0 x 7,5 | 2,5 | 0,05 |
| 00844 | 16,5 x 9,5 | 2,5 | 0,10 |



00907 0,20 ltr.

00908 0,30 ltr.

01023 0,40 ltr.

Schale „OLIVE“

bowl
cuenco
bol



aus geöltem Olivenholz
oiled olive wood
de madera de olivo aceitada
en bois d'olivier huilé

| | cm | ↑ cm | ltr. |
|-------|----------|------|------|
| 00907 | 13 x 8 | 6,5 | 0,2 |
| 00908 | 16 x 9 | 7,0 | 0,3 |
| 01023 | 25 x 8,5 | 7,5 | 0,4 |



01013 0,05 ltr.

01014 0,15 ltr.

01015 0,60 ltr.

Schale „OLIVE“

bowl
cuenco
bol

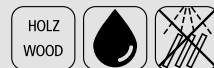

aus geöltem Olivenholz, naturbedingte Abweichung in Form, Maserung und Größe
oiled olive wood, natural deviation in shape, grain and size
de madera de olivo aceitada, diferencias naturales posibles en forma, grano y tamaño
en bois d'olivier huilé, éventuelles différences naturelles de forme, de grain et de taille

| | cm | ↑ cm | ltr. |
|-------|-------------|------|------|
| 01013 | 7,5 x 7,5 | 2,5 | 0,05 |
| 01014 | 17,5 x 8,5 | 2,5 | 0,15 |
| 01015 | 26,5 x 11,5 | 5,0 | 0,60 |



01022

01021

Servierbrett „OLIVE“

servicing board
tabla de servir
planche de service



aus geöltem Olivenholz, naturbedingte Abweichung in Form, Maserung und Größe
oiled olive wood, natural deviation in shape, grain and size
de madera de olivo aceitada, diferencias naturales posibles en forma, grano y tamaño
en bois d'olivier huilé, éventuelles différences naturelles de forme, de grain et de taille

| | cm | ↑ cm |
|-------|-------------|------|
| 01022 | 39,5 x 21 | 2,5 |
| 01021 | 35,5 x 18,5 | 2,0 |



mit Safrille
with juice groove



00905

00906

Servierbrett „OLIVE“

servicing board
tabla de servir
planche de service



aus geöltem Olivenholz, naturbedingte Abweichung in Form, Maserung und Größe
oiled olive wood, natural deviation in shape, grain and size
de madera de olivo aceitada, diferencias naturales posibles en forma, grano y tamaño
en bois d'olivier huilé, éventuelles différences naturelles de forme, de grain et de taille

| | cm | ↑ cm |
|-------|-------------|------|
| 00905 | 25,5 x 16,5 | 1,5 |
| 00906 | 35,0 x 20,5 | 1,5 |

**Servierbrett „OLIVE“**

serving board
tabla de servir
planche de service



aus geöltem Olivenholz, mit 19 mm Aufhäng Bohrung, naturbedingte Abweichung in Form, Maserung und Größe

oiled olive wood, natural deviation in shape, grain and size
de madera de olivo aceitada, diferencias naturales posibles en forma, grano y tamaño

en bois d'olivier huilé, éventuelles différences naturelles de forme, de grain et de taille

| | cm | ↑ cm | Griff / handle cm |
|-------|-------------|------|-------------------|
| 00870 | 25,0 x 17,0 | 1,5 | - |
| 00871 | 30,0 x 20,5 | 2,0 | - |
| 00875 | 19,0 x 12,5 | 1,5 | 6 |
| 00876 | 25,0 x 16,0 | 1,5 | 8 |
| 00877 | 31,0 x 20,0 | 1,5 | 9 |
| 00873 | 40,0 x 15,0 | 1,5 | 11 |
| 00874 | 44,0 x 20,0 | 2,0 | 12 |

**SNACKBOX „OLIVE“**

snackbox
caja tentempié
casse-croûte



aus geöltem Olivenholz

oiled olive wood
de madera de olivo aceitada
en bois d'olivier huilé

| | cm | ↑ cm |
|-------|---------|------|
| 01016 | 22 x 15 | 6 |
| 01017 | 25 x 18 | 6 |

**Tablett**

tray
bandeja
plateau



aus Bambus, geeignet zum Servieren und Transportieren

made of bamboo, suitable for serving and transport
de bambú, para servir y transportar
en bambou, pour servir et transporter

| | cm | ↑ cm | GN |
|-------|-------------|------|-----|
| 00845 | 32,5 x 26,5 | 3 | 1/2 |
| 00846 | 32,5 x 17,6 | 3 | 1/3 |



Präsentationsmöglichkeit
presentation example



Servierbrett „SHARING“

servicing board
tabla de servir
planche de service



Servierbrett aus geöltem Akazienholz
servicing board made of oiled acacia wood
tabla de servir de madera de acacia aceitada
planche en bois d'acacia huilé

| | cm | ↑ cm | Griff / handle cm |
|-------|-----------|------|-------------------|
| 00887 | 51,5 x 18 | 1,5 | 8,5 |



2 tlg.
2 pcs.

mit Absatz Ø 5 cm
with hole Ø 5 cm

Servierbrett

servicing board
tabla de servir
planche de service



2-teilig: 1 Holzbrett aus Akazienholz + 1 Naturschieferplatte
2 pcs.: 1 wood board made of acacia wood + 1 natural slate tray
set de 2: 1 tabla de madera de acacia + 1 bandeja de pizarra natural
set de 2: 1 planche en bois d'acacia + 1 plat ardoise naturelle

| | cm | ↑ cm |
|-------|-----------|------|
| 00814 | 28 x 17,5 | 2 |



2 tlg.
2 pcs.

Servierbrett

servicing board
tabla de servir
planche de service



2-teilig: 1 Holzbrett aus Akazienholz + 1 Naturschieferplatte
2 pcs.: 1 wood board made of acacia wood + 1 natural slate tray
set de 2: 1 tabla de madera de acacia + 1 bandeja de pizarra natural
set de 2: 1 planche en bois d'acacia + 1 plat ardoise naturelle

| | cm | ↑ cm | Griff / handle cm |
|-------|---------|------|-------------------|
| 00810 | 26 x 18 | 2 | 8 |
| 00811 | 33 x 20 | 2 | 8 |
| 00812 | 40 x 15 | 2 | 5 |
| 00813 | 43 x 12 | 2 | 12 |

Präsentationsmöglichkeit
presentation example



mit Hängeloch Ø 2 cm / with a handle-hole Ø 2 cm



Servierbrett „AKAZIE-SCHIEFER“

servicing board
tabla de servir
planche de service



raffiniertes, rustikales Servierbrett aus Akazienholz, ausgestattet mit einem Naturschieferstreifen zur Kennzeichnung
wood with slate, markable
madera con pizarra, se puede marcar
bois avec ardoise, on peut mettre une inscription

| | cm | ↑ cm | Griff / handle cm |
|-------|-----------|------|-------------------|
| 00867 | 30,5 x 13 | 1,5 | 10 |
| 00868 | 36,5 x 15 | 1,5 | 12 |
| 00869 | 42,0 x 18 | 1,5 | 14 |



NEW

Servierbrett

serving board
tabla de servir
planche de service



aus geöltem Akazienholz / made of oiled acacia wood / de madera de acacia aceitada / en bois d'acacia huilé

| | cm | ↑ cm |
|-------|---------|------|
| 00793 | 25 x 17 | 1,5 |



00898

40635

00899

Servierbrett

serving board
tabla de servir
planche de service



aus geöltem Akazienholz / made of oiled acacia wood / de madera de acacia aceitada / en bois d'acacia huilé

| | cm | ↑ cm |
|-------|---------|------|
| 00897 | 30 x 15 | 2 |
| 00898 | 30 x 18 | 2 |
| 00899 | 35 x 25 | 2 |



NEW

40685

Servierbrett

serving board
tabla de servir
planche de service



aus geöltem Akazienholz / made of oiled acacia wood / de madera de acacia aceitada / en bois d'acacia huilé

| | cm | ↑ cm |
|-------|--------|------|
| 00792 | 37 x 8 | 2 |



NEW

00791

00790

Servierschale

serving bowl
cuenca de servir
bol de service



aus geöltem Akazienholz / made of oiled acacia wood / de madera de acacia aceitada / en bois d'acacia huilé

| | cm | ↑ cm |
|-------|-----------|------|
| 00790 | 16,5 x 9 | 2 |
| 00791 | 23,5 x 13 | 2 |



00864

82312

82312

82312

00864

40685

40685

40685

00864

Servierbeispiel - Lieferung ohne Gläser
delivery without glasses

Servierbrett „NARROW I“

serving board
tabla de servir
planche de service



Akazienholz, mit 3 Vertiefungen Ø 4 cm

acacia wood, with 3 notches Ø 4 cm
madera de acacia, con 3 ranuras Ø 4 cm
bois d'acacia, avec 3 encoches Ø 4 cm

| | cm | ↑ cm |
|-------|--------|------|
| 00864 | 22 x 8 | 1,5 |

passende Schälchen / suitable bowls / cuencos adecuados / bols appropriés



| | Ø cm | ↑ cm | ltr. | |
|-------|------|------|------|-----------------|
| 82312 | 6 | 5,5 | 0,08 | glass / 12 pcs |
| 40685 | 6 | 3,0 | 0,05 | stainless steel |



Servierbrett „NARROW II“

serving board
tabla de servir
planche de service

Akazienholz, mit 3 Vertiefungen Ø 6 cm
acacia wood, with 3 notches Ø 6 cm
madera de acacia, con 3 ranuras Ø 6 cm
bois d'acacia, avec 3 encoches Ø 6 cm



| | cm | ↑ cm |
|-------|---------|------|
| 00878 | 31 x 11 | 2 |

**passende Schälchen / suitable bowls /
cuencos adecuados / bols appropriés**



| | Ø cm | ↑ cm | ltr. | |
|-------|------|------|------|-------------------|
| 40686 | 8 | 4,5 | 0,17 | stainless steel |
| 82316 | 7 | 8 | 0,22 | glass / 12 pcs. |
| 85080 | 8 | 7,5 | 0,05 | melamine / 3 pcs. |
| 85081 | 8 | 7,5 | 0,05 | melamine / 3 pcs. |



Holzbox „TABLE“

woodbox
caja madera
base bois

Akazienholz, 3 Fächer (6,5 x 6,5 cm)
acacia wood, 3 compartments (6,5 x 6,5 cm)
madera de acacia, 3 compartimentos (6,5 x 6,5 cm)
bois d'acacia, 3 compartiments (6,5 x 6,5 cm)



| | cm | ↑ cm | inner size cm |
|-------|------------|------|--------------------------------------|
| 11727 | 23,5 x 8,5 | 4,5 | 6,5 x 6,5 je Fach / each compartment |



Holzbox „TABLE“

woodbox
caja madera
base bois

Akazienholz, natur
acacia wood, nature
madera de acacia, natural
bois d'acacia, naturel



| | cm | ↑ cm | inner size cm |
|-------|----------|------|---------------|
| 11726 | 15 x 9,5 | 5 | 12 x 6,5 |



Serviertablett

serving tray
bandeja para servir
plateau de service

aus geöltem Eichenholz, mit 2 Griffmulden
made of oiled oak wood, with 2 recessed handles
de madera de roble aceitada, con 2 asas empotradas
en bois de chêne huilé, avec 2 poignées encastrées



| | cm | ↑ cm |
|-------|---------|------|
| 00761 | 45 x 35 | 6 |



Präsentationsmöglichkeit
presentation example

NEW

SIMPLY WOOD

simply
wood.

Eiche, das widerstandsfähigste europäische Holz, ist seit jeher Ausdruck von Qualität, Kraft und Energie.

Eichen werden uralt und riesen-groß, sind unvergleichlich stark und standfest.

Oak, the most resistant European wood, has always been an expression of quality, strength and energy.

Oaks grow to be ancient and huge, are incomparably strong and stable.

El roble, la madera europea más resistente, siempre ha sido una expresión de calidad, fuerza y energía.

Los robles se vuelven antiguos y enormes, son incomparablemente fuertes y estables.

Le chêne, le bois européen le plus résistant, est depuis toujours l'expression de la qualité, de la force et de l'énergie.

Les chênes deviennent très vieux et gigantesques, ils sont incomparablement forts et stables.

NEW



00750



00751



00752

Servierbrett „SIMPLY WOOD“

serving board
tabla de servir
planche de service



Eichenholz geölt, mit Aufhängeloch Ø 1,5 cm, mit Lederband

oak wood oiled, with handle hole Ø 1,5 cm, with leather strap

madera de roble aceitada, con agujero para colgar Ø 1,5 cm, con correa de cuero

bois de chêne huilé, avec trou de suspension Ø 1,5 cm, avec ruban en cuir

| | cm | ↑ cm | → Griff / handle |
|-------|---------|------|------------------|
| 00750 | 20 x 20 | 2 | 8 |
| 00751 | 27 x 17 | 2 | 8 |
| 00752 | 32 x 22 | 2 | 8 |



mit Lederband
with leather strap

NEW



Tablett / Sushiboard „SIMPLY WOOD“

tray / sushiboard
bandeja para sushi
plateau sushi

aus geöltem Eichenholz

made of oiled oak wood

de madera de roble aceitada

en bois de chêne huilé



| | cm | ↑ cm |
|-------|---------|------|
| 00753 | 35 x 17 | 2 |



GN 1/3 Servierbrett „SIMPLY WOOD“

GN 1/3 serving board
GN 1/3 tabla de servir
GN 1/3 planche de service



Eichenholz geölt, mit Vertiefung Ø 4 cm, mit Safrinne
oak wood oiled, with notch Ø 4 cm, with juice groove
madera de roble aceitada, con ranura Ø 4 cm, con ranura para líquidos
bois de chêne huilé, avec encoche Ø 4 cm, avec rigole

| | cm | ↑ cm | GN |
|-------|-------------|------|-----|
| 00754 | 32,5 x 17,6 | 2 | 1/3 |

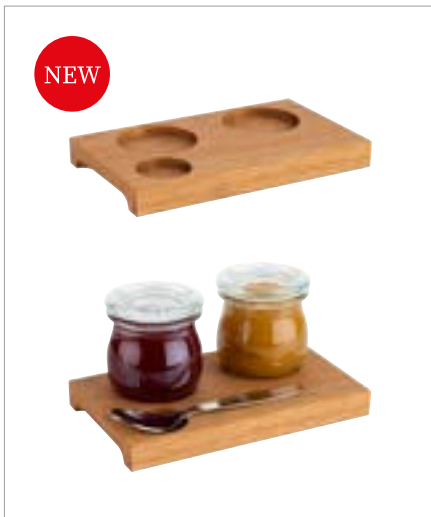

Servierbrett

serving board
tabla de servir
planche de service



Eichenholz, geölt, 2 Vertiefungen Ø 4,5 cm, 1 Vertiefung Ø 3 cm, mit 2 Griffmulden
oak wood oiled, 2 notches Ø 4,5 cm, 1 notch Ø 3 cm, with 2 recessed handles
madera de roble aceitada, 2 ranuras Ø 4,5 cm, 1 ranura Ø 3 cm, con 2 asas empotradas
bois de chêne huilé, 2 encoches Ø 4,5 cm, 1 encoche Ø 3 cm, avec 2 poignées encastées

| | cm | ↑ cm |
|-------|--------|------|
| 00835 | 15 x 9 | 1,5 |

passende Gläser / fitting glasses / tarros de vidrio adecuados / verrines appropriées

| | Ø cm | ↑ cm | ltr. | pcs |
|-------|------|------|-------|-----|
| 82350 | 5,5 | 6 | 0,075 | 12 |
| 82351 | 5,5 | 9 | 0,145 | 12 |



Servierbrett „PIZZA“

serving board
tabla de servir
planche de service



Eichenholz geölt, mit Safrinne, mit 2 Griffmulden
oak wood oiled, with juice groove, with 2 recessed handles
madera de roble aceitada, con ranura para líquidos, con 2 asas empotradas
bois de chêne huilé, avec rainure à jus, avec 2 poignées encastées

| | Ø cm | ↑ cm |
|-------|------|------|
| 00755 | 24 | 2 |
| 00756 | 29 | 2 |
| 00757 | 34 | 2 |



mit 2 Griffmulden an der Unterseite
with 2 recessed handles on the bottom

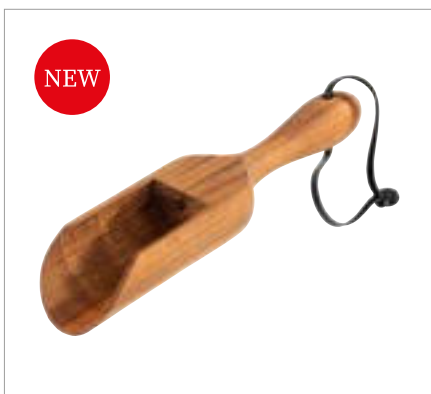

Schaufel

scoop
pala
pelle



aus geöltem Eichenholz, ideal für Gewürze, Körner etc.
made of oiled oak wood, ideal for spices, grains etc.
de madera de roble aceitada, ideal para especias, granos etc.
en bois de chêne huilé, idéal pour les épices, céréales, etc.

| | cm | ↑ cm |
|-------|----------|------|
| 01026 | 25,5 x 6 | 4,5 |

**Servierbrett „OAK“**

serving board
tabla de servir
planche de service

aus geöltem Eichenholz, Safrille, Ø 9,5 cm Aussparung

made of oiled oak, with juice groove, with hole Ø 9.5 cm

de madera de roble aceitada, con ranura para líquidos, con agujero Ø 9,5 cm

en bois chêne huilé, avec rigole, avec trou Ø 9,5 cm



| | cm | ↑ cm |
|-------|---------|------|
| 00808 | 37 x 25 | 2 |



mit Safrille
with juice groove

**Naturschieferplatte**

natural slate tray
bandeja pizarra natural
plat ardoise naturelle

mit Safrille, Ø 9,5 cm Aussparung

with juice groove, with hole Ø 9.5 cm

con ranura para líquidos, con agujero Ø 9,5 cm

avec rigole, avec trou Ø 9,5 cm



| | cm | * mm |
|-------|---------|-------|
| 00947 | 33 x 24 | 6 - 9 |

**Naturschieferplatte**

natural slate tray
bandeja pizarra natural
plat ardoise naturelle

mit Absatz Ø 6 cm

with hole Ø 6 cm

con agujero Ø 6 cm

avec trou Ø 6 cm



passende Gläser:
82310, 82312, 82314, 82316

| | cm | * mm |
|-------|---------|-------|
| 00986 | 25 x 12 | 6 - 9 |

**Naturschieferplatte**

natural slate tray
bandeja pizarra natural
plat ardoise naturelle

mit 3 Absätzen, Ø 6 cm

with 3 holes, Ø 6 cm

con 3 agujeros, Ø 6 cm

avec 3 trous, Ø 6 cm



passende Gläser:
82310, 82312, 82314, 82316

| | cm | * mm |
|-------|---------|-------|
| 00987 | 28 x 10 | 6 - 9 |

**Naturschieferplatte „STARTER“**

natural slate tray
bandeja de pizarra natural
plat ardoise naturelle carré



| | cm | * mm |
|-------|---------|-------|
| 00937 | 20 x 10 | 6 - 9 |

SERVING BOARDS | NATURAL SLATE



Weck-Glas 82316

Naturschieferplatte / Untersetzer

natural slate tray
bandeja de pizarra natural
plateau ardoise naturelle

mit 2 Absätzen Ø 6 cm / with 2 holes Ø 6 cm / con 2 agujeros Ø 6 cm / avec 2 trous Ø 6 cm



| | cm | ✱ mm |
|-------|--------|-------|
| 00971 | 15 x 8 | 6 - 9 |

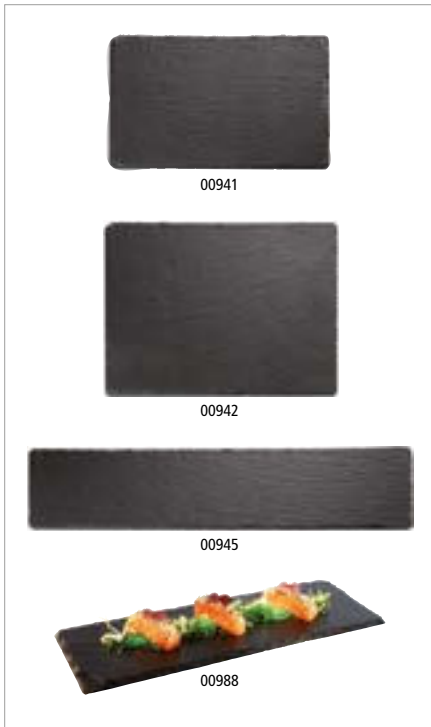

00941

00942

00945

00988

Naturschieferplatte

natural slate
bandeja de pizarra natural
plateau ardoise naturelle



| | cm | ✱ mm |
|-------|-------------|-------|
| 00941 | 24,0 x 15,0 | 6 - 9 |
| 00942 | 26,5 x 20,5 | 6 - 9 |
| 00945 | 47,0 x 10,0 | 6 - 9 |
| 00988 | 30,0 x 12,0 | 6 - 9 |

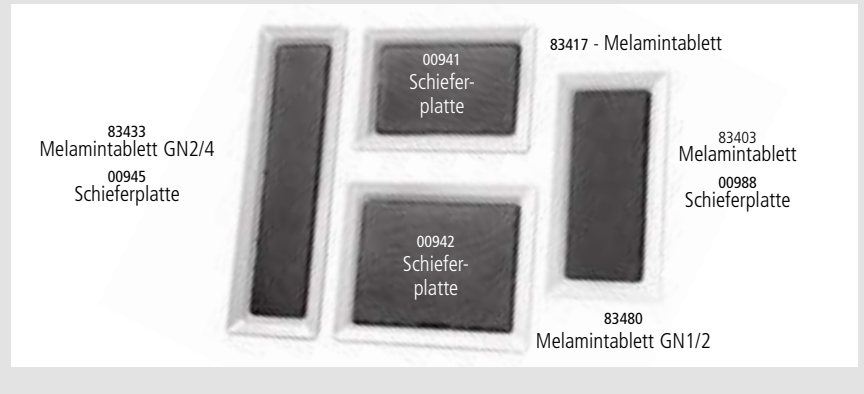

Naturschieferplatte

natural slate tray
bandeja de pizarra natural
plat ardoise naturelle



| | cm | ✱ mm |
|-------|---------|-------|
| 00996 | 45 x 30 | 6 - 9 |



00994

Naturschieferplatte

natural slate tray
bandeja de pizarra natural
plat ardoise naturelle



| | cm | ✱ mm |
|-------|---------|-------|
| 00994 | 25 x 25 | 6 - 9 |
| 00995 | 30 x 30 | 6 - 9 |



Naturschieferplatte, 2-teilig

natural slate tray, 2 pcs. set
bandeja de pizarra natural, set de 2
plateau ardoise naturelle, set de 2

mit Glashaube

with glass cover

con tapa de cristal

avec cloche en verre

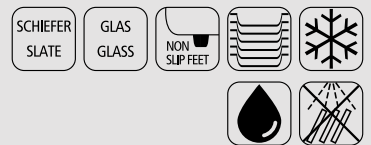

| | Ø cm | ↑ cm | ✱ mm |
|-------|------|------|-------|
| 00984 | 10,5 | 8 | 6 - 9 |



Tablett „VINTAGE“

tray
bandeja
plateau

Antik-Edelstahl-Look

stainless steel antique look
acero estilo antiguo
acier style antique



| | cm | ↑ cm | |
|-------|-------------|------|-------------|
| 30130 | 26,0 x 13,5 | 1,5 | rectangular |
| 30131 | 34,0 x 18,0 | 1,5 | rectangular |
| 30134 | 32,0 x 21,5 | 2,0 | rectangular |
| 30132 | 38,0 x 26,5 | 1,5 | rectangular |
| 30133 | 25,5 x 16,0 | 3,0 | angular |
| 30140 | 20 x 14,5 | 1,0 | oval |
| 30141 | 26,5 x 19,5 | 1,0 | oval |
| 30142 | 29,0 x 22,0 | 1,0 | oval |

passende Schälchen / fitting bowls / cuencos adecuados / bols apropiés



| | Ø cm | ↑ cm | ltr. |
|-------|------|------|------|
| 40655 | 7,5 | 5,5 | 0,17 |
| 40656 | 7,5 | 10 | 0,35 |

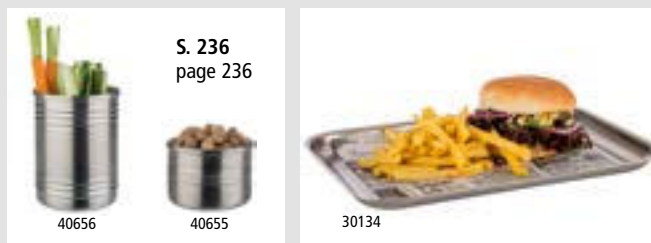

Tablett „TREND“

baking sheet
bandeja
plateau

ein Backblech wird zum Servierblech

a baking sheet which becomes a serving tray
una bandeja de hornear que se convierte en una bandeja de servir
un moule qui devient un plateau de service



| | cm | ↑ cm |
|-------|-----------|------|
| 13380 | 32 x 21,5 | 2 |



Wachspapier „SNACKHOLDER“

greaseproof paper squares
papel alimenticio
papier alimentaire



| | cm | pcs. | Motiv: |
|-------|---------|------|---------|
| 40670 | 42 x 25 | 500 | Zeitung |

MILLS



Pfeffermühle

pepper mill
molinillo de pimienta
moulin à poivre



aus Buchenholz, **Keramikmahlwerk**, Mahlgrad stufenlos einstellbar

made of beech wood, ceramic grinder, infinitely adjustable grinding degree

madera de haya, molinillo de cerámica, el grado de molino se puede ajustar de modo continuo

bois de hêtre, moulin en céramique, la finesse de mouture se peut réglée de façon continue

| | Ø cm | ↑ cm | Farbe / Colour |
|-------|------|------|----------------|
| 40570 | 5,5 | 15,5 | |
| 40571 | 5,5 | 15,5 | |
| 40572 | 6,0 | 23,0 | |
| 40573 | 6,0 | 23,0 | |



Keramikmahlwerk
ceramic grinder



einfach zu Öffnen
easy opening

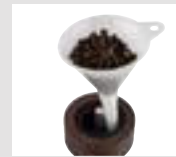

einfach zu Befüllen
easy to refill



Salzmühle

salt mill
molinillo de sal
moulin à sel



aus Buchenholz, **Keramikmahlwerk**, Mahlgrad stufenlos einstellbar

made of beech wood, ceramic grinder, infinitely adjustable grinding degree

madera de haya, molinillo de cerámica, el grado de molino se puede ajustar de modo continuo

bois de hêtre, moulin en céramique, la finesse de mouture se peut réglée de façon continue

| | Ø cm | ↑ cm | Farbe / Colour |
|-------|------|------|----------------|
| 40574 | 5,5 | 15,5 | |
| 40575 | 5,5 | 15,5 | |
| 40576 | 6,0 | 23,0 | |
| 40577 | 6,0 | 23,0 | |



Keramikmahlwerk
ceramic grinder

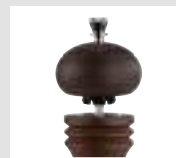

einfach zu Öffnen
easy opening





P



40535

40548

Pfeffermühle „PROFESSIONAL VINTAGE“pepper mill
molinillo de pimienta
moulin à poivre

Deutsches Buchenholz, Mahlwerk aus Carbonstahl, Mahlgrad stufenlos einstellbar
 german beechwood, mill in carbon steel, the grinding degree can be adjusted infinitely
 madera de haya alemana, molinillo de acero al carbono, el grado de molino se puede ajustar de modo continuo
 bois de hêtre d'Allemagne, moulin en acier de carbone, la finesse de mouture se peut réglée de façon continue

| | Ø cm | ↑ cm | Farbe / Colour |
|-------|------|------|----------------|
| 40535 | 5,5 | 15 | |
| 40537 | 6,0 | 23 | |
| 40546 | 5,5 | 15 | |
| 40548 | 6,0 | 23 | |

S



40536

40547

Salzmühle „PROFESSIONAL VINTAGE“salt mill
molinillo de sal
moulin à sel

deutsches Buchenholz, Mahlwerk aus Edelstahl, Mahlgrad stufenlos einstellbar
 german beechwood, mill in stainless steel, the grinding degree can be adjusted infinitely
 madera de haya alemana, molinillo de acero inoxidable, el grado de molino se puede ajustar de modo continuo
 bois de hêtre d'Allemagne, moulin en acier inox, la finesse de mouture se peut réglée de façon continue

| | Ø cm | ↑ cm | Farbe / Colour |
|-------|------|------|----------------|
| 40536 | 5,5 | 15 | |
| 40547 | 5,5 | 15 | |

P

**Pfeffermühle „GUNMETAL“**pepper mill
molinillo de pimienta
moulin à poivre

Mahlwerk aus Carbonstahl, Mahlgrad stufenlos einstellbar
 mill in carbon steel, the grinding degree can be adjusted infinitely
 molinillo de acero al carbono, el grado de molino se puede ajustar de modo continuo
 moulin en acier de carbone, la finesse de mouture se peut réglée de façon continue

| | Ø cm | ↑ cm |
|-------|------|------|
| 40555 | 6 | 15,5 |

S

**Salzmühle „GUNMETAL“**salt mill
molinillo de sal
moulin à sel

Mahlwerk aus Edelstahl, Mahlgrad stufenlos einstellbar
 mill in stainless steel, the grinding degree can be adjusted infinitely
 molinillo de acero inoxidable, el grado de molino se puede ajustar de modo continuo
 moulin en acier inox, la finesse de mouture se peut réglée de façon continue

| | Ø cm | ↑ cm |
|-------|------|------|
| 40556 | 6 | 15,5 |



Pfeffermühle „ELEMENT“

pepper mill
molinillo de pimienta
moulin à poivre



Mahlwerk aus Carbonstahl, Mahlgrad stufenlos einstellbar

mill in carbon steel, the grinding degree can be adjusted infinitely
molinillo de acero al carbono, el grado de molino se puede ajustar de modo continuo
moulin en acier de carbone, la finesse de mouture se peut régler de façon continue

| | Ø cm | ↑ cm |
|-------|------|------|
| 40538 | 6 | 18 |



Salzmühle „ELEMENT“

salt mill
molinillo de sal
moulin à sel



Mahlwerk aus Edelstahl, Mahlgrad stufenlos einstellbar

mill in stainless steel, the grinding degree can be adjusted infinitely
molinillo de acero inoxidable, el grado de molino se puede ajustar de modo continuo
moulin en acier inox, la finesse de mouture se peut régler de façon continue

| | Ø cm | ↑ cm |
|-------|------|------|
| 40539 | 6 | 18 |



Pfeffermühle „ELEMENT“

pepper mill
molinillo de pimienta
moulin à poivre



Mahlwerk aus Carbonstahl, Mahlgrad stufenlos einstellbar

mill in carbon steel, the grinding degree can be adjusted infinitely
molinillo de acero al carbono, el grado de molino se puede ajustar de modo continuo
moulin en acier de carbone, la finesse de mouture se peut réglée de façon continue

| | Ø cm | ↑ cm |
|-------|------|------|
| 40557 | 7,5 | 15,5 |



Salzmühle „ELEMENT“

salt mill
molinillo de sal
moulin à sel



Mahlwerk aus Edelstahl, Mahlgrad stufenlos einstellbar

mill in stainless steel, the grinding degree can be adjusted infinitely
molinillo de acero inoxidable, el grado de molino se puede ajustar de modo continuo
moulin en acier inox, la finesse de mouture se peut régler de façon continue

| | Ø cm | ↑ cm |
|-------|------|------|
| 40558 | 7,5 | 15,5 |



Pfeffermühle „PROFESSIONAL“

pepper mill
molinillo de pimienta
moulin à poivre



Mahlgrad stufenlos einstellbar

the grinding degree can be adjusted infinitely
el grado de molino se puede ajustar de modo continuo
la finesse de mouture se peut réglée de façon continue

| | Ø cm | ↑ cm |
|-------|------|------|
| 40540 | 5,5 | 15 |



S

Salzmühle „PROFESSIONAL“

salt mill
molinillo de sal
moulin à sel

**Mahlgrad stufenlos einstellbar**

the grinding degree can be adjusted infinitely
el grado de molino se puede ajustar de modo continuo
la finesse de mouture se peut réglée de façon continue

| | Ø cm | ↑ cm |
|-------|------|------|
| 40541 | 5,5 | 15 |



P

Pfeffermühle „DIAMOND“

pepper mill
molinillo de pimienta
moulin à poivre

**Mahlwerk aus Carbonstahl, Mahlgrad stufenlos einstellbar**

mill in carbon steel, the grinding degree can be adjusted infinitely
molinillo de acero al carbono, el grado de molino se puede ajustar de modo continuo
moulin en acier de carbone, la finesse de mouture se peut réglée de façon continue

| | Ø cm | ↑ cm |
|-------|------|------|
| 40553 | 6 | 18 |



S

Salzmühle „DIAMOND“

salt mill
molinillo de sal
moulin à sel

**Mahlwerk aus Edelstahl, Mahlgrad stufenlos einstellbar**

mill in stainless steel, the grinding degree can be adjusted infinitely
molinillo de acero inoxidable, el grado de molino se puede ajustar de modo continuo
moulin en acier inox, la finesse de mouture se peut réglée de façon continue

| | Ø cm | ↑ cm |
|-------|------|------|
| 40554 | 6 | 18 |



P

Pfeffermühle „FRIDA“

pepper mill
molinillo de pimienta
moulin à poivre

**Mahlwerk aus Carbonstahl, Mahlgrad stufenlos einstellbar**

mill in carbon steel, the grinding degree can be adjusted infinitely
molinillo de acero al carbono, el grado de molino se puede ajustar de modo continuo
moulin en acier de carbone, la finesse de mouture se peut réglée de façon continue

| | Ø cm | ↑ cm |
|-------|------|------|
| 40549 | 6 | 15,5 |



S

Salzmühle „FRIDA“

salt mill
molinillo de sal
moulin à sel

**Mahlwerk aus Edelstahl, Mahlgrad stufenlos einstellbar**

mill in stainless steel, the grinding degree can be adjusted infinitely
molinillo de acero inoxidable, el grado de molino se puede ajustar de modo continuo
moulin en acier inox, la finesse de mouture se peut réglée de façon continue

| | Ø cm | ↑ cm |
|-------|------|------|
| 40550 | 6 | 15,5 |

SALT- / PEPPER MILLS



P

Pfeffermühle „COPPER“

pepper mill
molinillo de pimienta
moulin à poivre



Mahlwerk aus Carbonstahl, Mahlgrad stufenlos einstellbar

mill in carbon steel, the grinding degree can be adjusted infinitely
molinillo de acero al carbono, el grado de molino se puede ajustar de modo continuo
moulin en acier de carbone, la finesse de mouture se peut réglée de façon continue

| | Ø cm | ↑ cm |
|-------|------|------|
| 40551 | 6 | 15 |



S

Salzmühle „COPPER“

salt mill
molinillo de sal
moulin à sel



Mahlwerk aus Edelstahl, Mahlgrad stufenlos einstellbar

mill in stainless steel, the grinding degree can be adjusted infinitely
molinillo de acero inoxidable, el grado de molino se puede ajustar de modo continuo
moulin en acier inox, la finesse de mouture se peut réglée de façon continue

| | Ø cm | ↑ cm |
|-------|------|------|
| 40552 | 6 | 15 |



NEW

3-tlg.
3 pcs.

P

S

40417

40418

Pfeffer- und Salz-Menage „URBAN“

salt- and pepper-menage
salero-pimentero
ménage sel et poivre



3-teiliges Set, bestehend aus:

- Gestell, Metall, schwarz, mit Kartenhalterung
- Pfeffermühle aus Akazienholz mit Mahlwerk aus Carbonstahl
- Salzmühle aus Akazienholz mit Mahlwerk aus Edelstahl

3 pcs., consisting of:

- stand, metal, black, with card holder
- pepper mill made of acacia wood with grinding mechanism made of carbon steel
- salt mill made of acacia wood with grinding mechanism made of stainless steel

set de 3, compuesto por:

- soporte, metal, negro, con porta menu
- molinillo de pimienta de madera de acacia con mecanismo de molienda de acero al carbono
- molinillo de sal de madera de acacia con mecanismo de molienda de acero inoxidable

set de 3, composé de :

- support, métal, noir, avec porte-cartes
- moulin à poivre en bois d'acacia avec broyeur en acier au carbone
- moulin à sel en bois d'acacia avec broyeur en acier inox

| | cm | ↑ cm |
|-------|----------|------|
| 40416 | 12 x 8,5 | 24 |

Pfeffermühle / pepper mill / molinillo de pimienta / moulin à poivre

| | Ø cm | ↑ cm |
|-------|------|------|
| 40417 | 5 | 17 |

Salzmühle / salt mill / molinillo de sal / moulin à sel

| | Ø cm | ↑ cm |
|-------|------|------|
| 40418 | 5 | 17 |



Naturschieferplatte / Untersetzer

natural slate tray
bandeja de pizarra natural
plateau ardoise naturelle



mit 2 Absätzen Ø 6 cm / with 2 holes Ø 6 cm / con 2 agujeros Ø 6 cm / avec 2 trous Ø 6 cm

| | cm | * mm |
|-------|--------|-------|
| 00971 | 15 x 8 | 6 - 9 |



2 in 1 Salz- und Pfeffermühle

2 in 1 salt and pepper mill
2 in 1 molinillo de sal y pimienta
2 in 1 moulin à sel et poivre



Keramik Mahlwerk / ceramic mechanism / molinillo de céramica / broyeur en céramique

| | Ø cm | ↑ cm |
|-------|------|------|
| 40545 | 7,5 | 18,5 |



Mahlgrad einstellbar
grinder setting

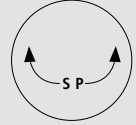

2 in 1 Salz- und Pfeffermühle

2 in 1 salt and pepper mill
2 in 1 molinillo de sal y pimienta
2 in 1 moulin à sel et poivre



Keramik Mahlwerk / ceramic mechanism / molinillo de céramica / broyeur en céramique

| | cm | ↑ cm |
|-------|---------|------|
| 40544 | 6 x 4,5 | 9,5 |



Mahlgrad einstellbar
grinder setting

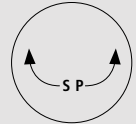

40500 - 2er Set
1 Salz- und 1 Pfeffer-
streuer

40501 - 2er Set
1 Salz- und
Pfefferstreuer

40507 - 2er Set
1 Salz- und
1 Pfefferstreuer

Salz- und Pfefferstreuer, 2er Set

salt - and pepper shaker, 2 pcs.
piezas de sal y pimienta, set de 2
sel et poivre, set de 2



| | Ø cm | ↑ cm | pcs. | |
|-------|------|------|------|--|
| 40500 | 5 | 6,5 | 2 | glatte Ausführung / smooth version versión recta / forme lisse |
| 40501 | 5 | 6,5 | 2 | geriffelte Ausführung / fluted version versión ondulada / forme ondulée |
| 40507 | 6 | 10,0 | 2 | |

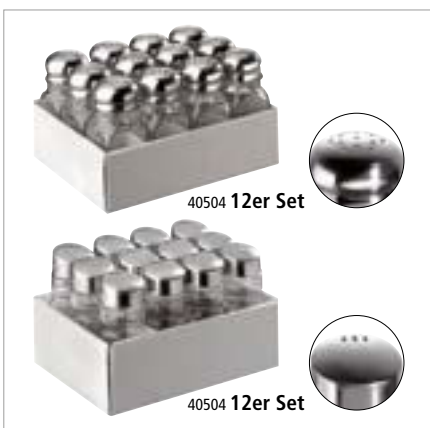

40504 12er Set

40504 12er Set

Allzweckstreuer, 12er Set

shaker, 12 pcs.
dosificador, set de 12
salières/poivrières, set de 12



| | cm | ↑ cm | pcs. | |
|-------|-------|------|------|--|
| 40504 | 4 x 4 | 10 | 12 | 13 Löcher / 13 holes 13 agujeros / 13 trous |
| 40505 | Ø cm | ↑ cm | pcs. | |
| | 3 | 9 | 12 | 3 Löcher / 3 holes 3 agujeros / 3 trous |



Ministreuer, 4er Set

mini shaker, 4 pcs.
dosificador mini, set de 4
mini-salières, set de 4



| | Ø cm | ↑ cm | pcs. |
|-------|------|------|------|
| 40503 | 3,5 | 4 | 4 |

SALT- / PEPPER MILLS



Multistreuer

multi-functional shaker
multi dosificador
saupoudreuse



Lochgröße einstellbar / adjustable hole size / tamaño del agujero ajustable / taille du trou réglable

| | Ø cm | ↑ cm | ltr. |
|-------|------|------|------|
| 00773 | 6 | 8 | 0,05 |
| 00774 | 7 | 12 | 0,20 |
| 00781 | 6,5 | 12 | 0,20 |
| 00782 | 6,5 | 12 | 0,20 |
| 00783 | 6,5 | 12 | 0,20 |



Netzstreuer

mesh top shaker
polvoreador, tapa con malla fina
pot à épices, couvercle toile fine



| | Ø cm | ↑ cm | ltr. |
|-------|------|------|------|
| 00776 | 5,5 | 7,5 | 0,15 |



Streuer fein

small hole shaker
polvoreador, tapa con agujeros pequeños
pot à épices, couvercle à petits trous



| | Ø cm | ↑ cm | ltr. |
|-------|------|------|------|
| 00777 | 5,5 | 7,5 | 0,15 |



Streuer grob

large hole shaker
polvoreador, tapa con agujeros grandes
pot à épices, couvercle à grands trous



| | Ø cm | ↑ cm | ltr. |
|-------|------|------|------|
| 00778 | 5,5 | 7,5 | 0,15 |



Käse- oder Gewürzstreuer

spice shaker
bote especiero
saupoudreuse à épices



| | Ø cm | ↑ cm | ltr. |
|-------|------|------|------|
| 00775 | 5,5 | 7,5 | 0,15 |



Salzstreuer

salt shaker
salero
salière



Pommes-Frites Streuer mit Schraubkappe / for french fries, cover to screw / para patatas fritas, tapa de rosca / pour les frites, couvercle à visser

| | Ø cm | ↑ cm | |
|-------|------|------|-----------------------------|
| 00779 | 8 | 17 | Aluminium / aluminium |
| 00772 | 8 | 17 | Edelstahl / stainless steel |

MENAGES



Menage „WOOD“

menage
menage
ménage



matt poliert, Glasbehälter mit Edelstahldeckel und Deckelverschluss

matt polished, glass with stainless steel cover
pulido mate, cristal con tapa de acero inoxidable
verre et inox poli mat, avec couvercle inox

| | cm | ↑ cm |
|-------|------------|------|
| 40435 | 11,5 x 5,5 | 17 |



Menage „WOOD“

menage
menage
ménage



matt poliert, Glasbehälter mit Edelstahldeckel und Deckelverschluss

matt polished, glass with stainless steel cover
pulido mate, cristal con tapa de acero inoxidable
verre et inox poli mat, avec couvercle inox

| | cm | ↑ cm |
|-------|----------|------|
| 40436 | 16 x 7,5 | 24,5 |



Menage „WOOD“

menage
menage
ménage



matt poliert, möbelschonende Unterseite

matt polished, glass with stainless steel cover
pulido mate, con tapa de acero inoxidable
verre et inox poli mat, avec couvercle inox

| | cm | ↑ cm |
|-------|-----------|------|
| 40437 | 15,5 x 12 | 24,5 |

Salz- und Pfefferstreuer / salt - and pepper shaker / juego de sal y pimienta / set sel et poivre

| | Ø cm | ↑ cm | |
|-------|------|------|-----------------------|
| 40438 | 4 | 9 | 6 Löcher - Ø 1,85 mm |
| 40439 | 4 | 9 | 18 Löcher - Ø 1,35 mm |

Ersatzglas Essig / Öl / spare glass vinegar / oil / cristal de recambio con tapa „aceite & vinagre“
verre huile ou vinagre

| | Ø cm | ↑ cm | ltr. |
|-------|------|------|------|
| 40442 | 6 | 18,5 | 0,2 |



Menage „ELEMENT“

menage
menage
ménage



Betonständer, Glasbehälter mit Edelstahldeckel, möbelschonende Unterseite

stand made of concrete, glass with stainless steel cover, furniture-friendly underside
soporte de hormigón, recipiente de vidrio con tapa de acero inoxidable, con base anti rayaduras

support en béton, récipient en verre avec couvercle en acier inox, revêtement antirayures

| | cm | ↑ cm |
|-------|--------|------|
| 40410 | 10 x 6 | 17 |



Menage „ELEMENT“

menage
menage
ménage



Betonständer, Glasbehälter mit Edelstahldeckel und tropffreiem Kunststoff-Ausgießer, möbelschonende Unterseite

stand made of concrete, glass with stainless steel cover and non-drip nozzle-spout, furniture-friendly underside

soporte de hormigón, recipiente de vidrio con tapa de acero inoxidable y sistema antigoteo, base anti rayaduras

support en béton, récipient en verre avec couvercle en acier inox et verseur antigoutte, revêtement antirayures

| | cm | ↑ cm |
|-------|--------|------|
| 40411 | 14 x 8 | 25 |



Menage „ELEMENT“

menage
menage
ménage



Betonständer, Glasbehälter mit Edelstahldeckel und Drehverschluss, möbelschonende Unterseite

stand made of concrete, glass with stainless steel cover and screw cap, furniture-friendly underside

soporte de hormigón, recipiente de vidrio con tapa de acero inoxidable y tapón de rosca, base anti rayaduras

support en béton, récipient en verre avec couvercle en acier inox et bouchon à vis, avec revêtement antirayures

| | cm | ↑ cm |
|-------|-------------|------|
| 40412 | 12,5 x 12,5 | 25 |



Menage „ELEMENT“

menage
menage
ménage



Betonständer mit Kartenhalterung, Glasbehälter mit Edelstahldeckel und Drehverschluss, möbelschonende Unterseite

stand made of concrete with card holder, glass with stainless steel cover and screw cap, furniture-friendly underside

soporte de hormigón con tarjetero, recipiente de vidrio con tapa de acero inoxidable y tapón de rosca, base anti rayaduras

support en béton avec porte-cartes, récipient en verre avec couvercle en acier inox et bouchon à vis, revêtement antirayures

| | cm | ↑ cm |
|-------|-----------|------|
| 40413 | 14 x 13,5 | 20 |



mit Kartenhalterung an der Rückseite
with card holder at the back



Menage „CLASSIC“

menage
menage
ménage



Glasbehälter mit Edelstahldeckel und Drehverschluss

glass with stainless steel cover
vidrio con tapa de acero inoxidable con rosca
en verre avec couvercle inox à visser

| | cm | ↑ cm |
|-------|------------|------|
| 40310 | 10,5 x 6,5 | 16 |



Menage „CLASSIC“

menage
menage
ménage



Glasbehälter mit Edelstahldeckel und Drehverschluss

glass with stainless steel cover
vidrio con tapa de acero inoxidable con rosca
en verre avec couvercle inox à visser

| | Ø cm | ↑ cm |
|-------|------|------|
| 40320 | 10,5 | 16 |



Menage „CLASSIC“

menage
menage
ménage



Glasbehälter mit Edelstahldeckel und tropffreiem Kunststoff-Ausgießer

with stainless steel cover and non-drip nozzle-spout
vidrio con tapa inox y sistema antigoteo
verre avec couvercle inox et verseur antigoutte

| | cm | ↑ cm | ltr. |
|-------|-------------|------|------|
| 40440 | 14,5 x 8,5 | 23 | 0,2 |
| 40450 | 17,5 x 10,5 | 23 | |

Ersatzglas mit Deckel / spare glass with cover / vidrio con tapa / verre + couvercle

| | Ø cm | ↑ cm | |
|-------|------|------|-----------------------|
| 40312 | 4 | 9 | 18 Löcher - Ø 1,35 mm |
| 40311 | 4 | 9 | 6 Löcher - Ø 1,85 mm |

Ersatzglas mit Deckel „Essig & Öl“ / spare glass with cover „vinegar & oil“ / cristal de recambio con tapa „vinegar & oil“ / verre huile ou vinaige avec couvercle inox et verseur antigoutte

| | Ø cm | ↑ cm | ltr. |
|-------|------|------|------|
| 40441 | 6 | 18,5 | 0,2 |

Ersatzglas mit Deckel „Zahnstocher“ / spare glass with cover „toothpick“ / porta-palillos vidrio con tapa / verre à cure-dents + couvercle

| | Ø cm | ↑ cm |
|-------|------|------|
| 40313 | 4 | 9 |



Senftöpfchen, 2er Set

mustard glass, 2 pcs. set
piezas vasos mostaza, set de 2
verres à moutarde, set de 2



inklusive Löffel und Edelstahldeckel

including spoons and covers
incluye cucharas y tapas
cuillères et couvercles inclus

| | Ø cm | ↑ cm | ltr. | pcs. |
|-------|------|------|------|------|
| 40415 | 5 | 6 | 0,07 | 2 |



Menage „ECONOMIC“

menage
menage
ménage



Glasbehälter mit Edelstahldeckel und Drehverschluss

glass with stainless steel cover
cristal con tapa inox a rosca
en verre avec couvercle inox à visser

| | cm | ↑ cm |
|-------|-------|------|
| 40455 | 8 x 4 | 13 |



Menage „ECONOMIC“

menage
menage
ménage



Glasbehälter mit Edelstahldeckel und Drehverschluss

glass with stainless steel cover
cristal con tapa inox a rosca
en verre avec couvercle inox à visser

| | cm | ↑ cm |
|-------|-------|------|
| 40457 | 8 x 8 | 12 |

Glas für Senf / glass for mustard / vaso de cristal para mostaza / pot verre seul pour la moutarde

40464



Menage „ECONOMIC“

menage
menage
ménage



Glasbehälter mit Edelstahldeckel und tropffreiem Kunststoff-Ausgießer

glasses with stainless steel cover and non-drip nozzle-spout
cristales con tapa de acero inoxidable y sistema antigoteo
en verre avec couvercle inox et insert plastique antigoutte

| | cm | ↑ cm |
|-------|-------------|------|
| 40458 | 11,5 x 5,5 | 22 |
| 40460 | 11,0 x 10,5 | 22 |

Pfeffer- oder Salz-Glasstreuer / pepper- or salt-glass with cover salero o pimentero de cristal con tapa / salière ou poivrière seule en verre avec couvercle inox

| | Ø cm | ↑ cm |
|-------|------|------|
| 40461 | 3 | 9 |

Essig- oder Öl-Glasbehälter / oil- or vinegar-glass with cover / aceitera-vinagrera con tapa bouteille huile ou vinaigre seule en verre et couv. inox

| | Ø cm | ↑ cm |
|-------|------|------|
| 40462 | 4,5 | 16 |

Glas für Zahnstocher / glass for tooth picks / vaso de cristal para palillos de dientes porte-cure-dents env erre

| | Ø cm | ↑ cm |
|-------|------|------|
| 40463 | 3 | 6 |



40476



40478



40480

Menage „PRO“

menage
menage
ménage



matt poliert, Glasbehälter mit Edelstahldeckel und tropffreiem Kunststoff-Ausgießer

matt polished, glass with stainless steel cover and non-drip nozzle-spout

pulido mate, vidrio, sistema antigoteo

poli mat et verre, insert plastique antigoutte

| | cm | ↑ cm |
|-------|-------------|------|
| 40476 | 12,0 x 8,0 | 19 |
| 40478 | 12,5 x 11,0 | 19 |
| 40480 | 13,0 x 11,0 | 19 |

Pfeffer- oder Salz-Glasstreuer / pepper- or salt-glass with cover / salero o pimentero de cristal con tapa / salière ou poivrière seule en verre avec couvercle inox

| | Ø cm | ↑ cm |
|-------|------|------|
| 40461 | 3 | 9 |

Essig- oder Öl-Glasbehälter / oil- or vinegar-glass with cover / aceitera-vinagrera con tapa bouteille huile ou vinaigre seule en verre et couv. inox

| | Ø cm | ↑ cm |
|-------|------|------|
| 40462 | 4,5 | 16 |



40470



40472



40474

Menage „PRO“

menage
menage
ménage



matt poliert, Glasbehälter mit Edelstahldeckel und Drehverschluss

matt polished, glass with stainless steel cover

pulido mate, vidrio y tapas con rosca

poli mat et verre, couvercle à visser

| | cm | ↑ cm |
|-------|-------------|------|
| 40470 | 8,5 x 5,5 | 11,5 |
| 40472 | 9,0 x 8,5 | 11,5 |
| 40474 | 10,0 x 10,0 | 11,5 |



NEW

Parmesan-Menage „CLASSIC“

cheese dish
quesera parmesano
service à parmesan

schwarz matt, inklusive Löffel
black mat, with spoon
negro, con bol cristal y cuchara
noir, avec bol verre et cuillère



| | Ø cm | ↑ cm | ltr. |
|-------|------|------|------|
| 40333 | 11,0 | 7,0 | 0,18 |

Ersatzbehälter / sparecontainer / bol de recambio / bol de rechange

| | Ø cm | ↑ cm | ltr. |
|-------|------|------|------|
| 40331 | 9,0 | 5,0 | 0,18 |



Parmesan-Menage „CLASSIC“

cheese dish
quesera parmesano
service à parmesan

hochglanzpoliert, inklusive Löffel
mirror polished, with spoon
pulido brillante, con bol cristal y cuchara
poli brillante, avec bol verre et cuillère



| | Ø cm | ↑ cm | ltr. |
|-------|------|------|------|
| 40330 | 11,0 | 7,0 | 0,18 |

Ersatzbehälter / sparecontainer / bol de recambio / bol de rechange

| | Ø cm | ↑ cm | ltr. |
|-------|------|------|------|
| 40331 | 9,0 | 5,0 | 0,18 |



Parmesan-Menage „PROFI“

cheese dish
quesera parmesano
service à parmesan

hochglanzpoliert, inklusive Löffel
mirror polished, with spoon
pulido brillante, con bol cristal y cuchara
brillant, avec bol verre et cuillère



| | Ø cm | ↑ cm | ltr. |
|-------|------|------|------|
| 40424 | 9,0 | 6,5 | 0,18 |

Ersatzbehälter / spare container / bol de recambio / bol de rechange

| | Ø cm | ↑ cm | ltr. |
|-------|------|------|------|
| 40331 | 9,0 | 5,0 | 0,18 |



Parmesan-Menage „PRO“

cheese dish
quesera parmesano
service à parmesan

matt poliert, inklusive Löffel
matt polished, with spoon
pulido mate, con bol cristal y cuchara
poli mat, avec bol verre et cuillère



| | Ø cm | ↑ cm | ltr. |
|-------|------|------|------|
| 40482 | 10,5 | 13,0 | 0,18 |

Ersatzbehälter / sparecontainer / bol de recambio / bol de rechange

| | Ø cm | ↑ cm | ltr. |
|-------|------|------|------|
| 40331 | 9,0 | 5,0 | 0,18 |



Parmesan-Menage „ECONOMIC“

cheese dish
quesera parmesano
service à parmesan
inklusive Kunststofflöffel
with spoon
con cuchara
avec cuillère



| | Ø cm | ↑ cm | litr. |
|-------|------|------|-------|
| 40453 | 10,0 | 7,5 | 0,23 |

Ersatzbehälter / sparecontainer / bol de recambio / bol de rechange

| | Ø cm | ↑ cm | litr. |
|-------|------|------|-------|
| 40454 | 9,0 | 5,5 | 0,23 |



Essig- & Öl-Menage

oil- and vinegar-menage
aceitera-vinagrera
ménage huile et vinaigre



Glasbehälter mit Deckel und tropffreiem PE-Ausgießer

glass with lid and non-drip nozzle-spout
recipiente de cristal con tapa y sistema antigoteo
pot en verre avec couvercle et système plastique antigoutte



| | cm | ↑ cm | litr. |
|-------|------------|------|-------|
| 40445 | 10,5 x 5,5 | 24 | 0,12 |
| 40446 | 13,0 x 7,0 | 34 | 0,50 |



tropffreier Ausgießer
non-drip spout

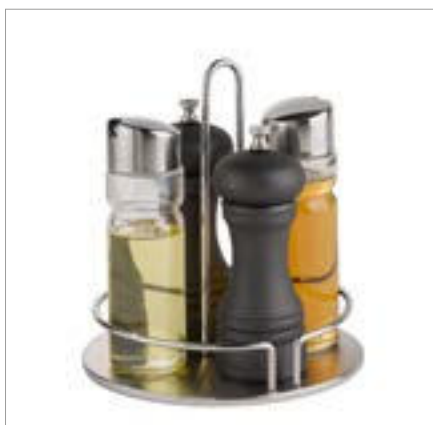

Gewürzständer

condiment stand
soporte salsas y condimentos
porte condiments et sauces



matt poliert
matt polished
pulido mate
poli mat

| | Ø cm | ↑ cm |
|-------|------|------|
| 40300 | 18 | 20 |



Menage

menage
menage
ménage



drehbares Gestell, Glasbehälter mit Edelstahldeckel und Drehverschluss

rotating stand, glass with stainless steel cover
soporte giratorio con piezas de vidrio y tapas inox
tournant, avec pièces en verre et couvercle inox

| | Ø cm | ↑ cm |
|-------|------|------|
| 40485 | 16 | 20 |



Ständer „URBAN“

serving stand
soporte 2 botellas
support 2 bouteilles

Metall schwarz, mit Kartenhalterung

metal black, with card holder
metal negro, con tarjetero
métal noir, avec porte-cartes



| | cm | ↑ cm |
|-------|----------|------|
| 40414 | 13 x 8,5 | 25 |

Pfeffermühle / pepper mill / molinillo de pimienta / moulin à poivre

| | Ø cm | ↑ cm |
|-------|------|------|
| 40555 | 6 | 15,5 |

Salzmühle / salt mill / molinillo de sal / moulin à sel

| | Ø cm | ↑ cm |
|-------|------|------|
| 40556 | 6 | 15,5 |



mit Kartenhalterung an der Rückseite
with card holder at the back



Spritzflasche inklusive Ausgießer

squeeze bottle with nozzle
botella exprimible con dosificador
flacon pulvérisateur avec bec verseur
ideal für Bitter-Liköre, Essig, Öl

perfect for bitter liqueur, vinegar, oil
perfecto para licores amargos, vinagre, aceite
idéal pour liqueur amère, vinaigre, huile



| | cm | ↑ cm | litr. |
|-------|-------|------|-------|
| 93308 | 6 x 5 | 20 | 0,2 |

Ersatzausgießer passend für Spritzflasche / nozzle suitable for squeeze bottle / dosificador apto para botella exprimible / bec verseur approprié pour flacon pulvérisateur

| | Ø cm | ↑ cm |
|-------|------|------|
| 93309 | 2,5 | 5,5 |



Essig- & Öl-Flasche „OLD FASHIONED“

oil- and vinegar bottle
botella de aceite y vinagre
bouteille d'huile et vinaigre

Glasflasche, Edelstahl - Ausgießer mit Deckel

glass bottle, stainless steel spout with lid
botella de vidrio, pico verteder de acero inoxidable con tapa
bouteille en verre, bec verseur en acier inox avec couvercle



| | Ø cm | ↑ cm | litr. |
|-------|------|------|-------|
| 40511 | 7 | 22 | 0,35 |

**Zuckerkugel**sugar pot
azucarero
sucrier**hochglanzpoliert, mit Rolldeckel**mirror polished, rolltop cover
pulido brillante, tapa abatible
poli brillant, couvercle abattant

| | Ø cm | ↑ cm |
|-------|------|------|
| 00033 | 13,5 | 15 |



170 ml

Zuckerspendersugar pourer
dispensador de azúcar
sucrier doseur**matt poliert / matt polished / pulido mate / poli mat**

| | Ø cm | ↑ cm | ltr. |
|-------|------|------|------|
| 10316 | 5 | 15 | 0,17 |



200 ml

Zuckerdosierersugar dispenser
azucarero
sucrier**Schraubdeckel aus Edelstahl, mit Dosierrohr**cover stainless steel, with dosing tube
tapa inoxidable y tubo, con tubo dosificador
couvercle inox et tube doseur

| | Ø cm | ↑ cm | ltr. |
|-------|------|------|------|
| 40509 | 6 | 14,5 | 0,2 |



200 ml

Zuckerdosierersugar dispenser
azucarero
sucrier**mit Schraubverschluss, Dosierrohr**cover and dosing tube
con tapa y tubo dosificador
couvercle avec tube doseur

| | Ø cm | ↑ cm | ltr. |
|-------|------|------|------|
| 40508 | 6,5 | 14,5 | 0,20 |



300 ml

Zuckerdosierersugar dispenser
azucarero
sucrier**Schraubdeckel aus Edelstahl / cover stainless steel / tapa inoxidable / couvercle inox**

| | Ø cm | ↑ cm | ltr. |
|-------|------|------|------|
| 00766 | 8,5 | 15 | 0,3 |

Ersatzglasbehälter / spare glas-container / contenedor de repuesto / récipient verre de rechange

00768

SUGAR DISPENSERS



320 ml

Zuckerdosierer

sugar dispenser
azucarero
sucrier



Schraubdeckel aus Edelstahl, mit Dosierrohr

cover stainless steel, with dosing tube
tapa inoxidable y tubo dosificador
couvercle inoxydable et tube doseur

| | Ø cm | ↑ cm | ltr. |
|-------|------|------|------|
| 40506 | 7,5 | 17,0 | 0,32 |



250 ml

Zuckerdosierer

sugar dispenser
azucarero
sucrier



Schraubdeckel aus Edelstahl, mit Dosierrohr

cover stainless steel, with dosing tube
tapa inoxidable y tubo, con tubo dosificador
couvercle inox et tube doseur

| | Ø cm | ↑ cm | ltr. |
|-------|------|------|------|
| 40486 | 8 | 15 | 0,25 |



40490 150 ml

40494 250 ml

Zuckerdosierer

sugar dispenser
azucarero
sucrier



Schraubdeckel aus Edelstahl, mit Dosierrohr

cover stainless steel with dosing tube
tapa inoxidable y tubo dosificador
couvercle inox et tube doseur

| | Ø cm | ↑ cm | ltr. |
|-------|------|------|------|
| 40490 | 8,5 | 12 | 0,15 |
| 40494 | 8,0 | 15 | 0,25 |



320 ml

Zuckerdosierer

sugar dispenser
azucarero
sucrier



Schraubdeckel mit Klappe aus Edelstahl, mit Dosierklappe

cover stainless steel, with dosing flap
tapa acero inoxidable, con tubo dosificador
couvercle inox, avec couvercle doseur

| | Ø cm | ↑ cm | ltr. |
|-------|------|------|------|
| 40487 | 7,5 | 13,5 | 0,32 |



350 ml

Zuckerdosierer „OLD FASHIONED“

sugar dispenser
azucarero
sucrier



Schraubdeckel mit Klappe aus Edelstahl, mit Dosierklappe

cover stainless steel, with dosing flap
tapa acero inoxidable, con tubo dosificador
couvercle inox, avec couvercle doseur

| | Ø cm | ↑ cm | ltr. |
|-------|------|------|------|
| 40510 | 7,5 | 14 | 0,35 |



300 ml

Allzweckgießer

pourer
bote vertedor universal
pot verseur universel

für Honig, Kaffeesahne, etc., Schraubdeckel aus Edelstahl

for honey, cream, etc., cover stainless steel

para miel, crema, etc., tapa inoxidable

pour le miel, le lait, la crème, etc., couvercle inox



| | Ø cm | ↑ cm | ltr. |
|-------|------|------|------|
| 00765 | 8,5 | 13,5 | 0,3 |

Ersatzglasbehälter / spare glas-container / contenedor de repuesto / récipient verre de rechange

00768



250 ml

Allzweckgießer

pourer
dosificador
doseur

Schraubdeckel aus Edelstahl und Kunststoff, mit Dosierklappe

cover stainless steel and plastic, with dosing flap

acero inoxidable y tapa plástico, con tubo dosificador

couvercle en inox et plastique, avec couvercle doseure



| | Ø cm | ↑ cm | ltr. |
|-------|------|------|------|
| 40488 | 8 | 12,5 | 0,25 |

**Milchkännchen, 4er Set**

milk/cream jugs, 4 pcs.
pack de 4 jarritas para leche o crema
pack de 4 crémiers

hochglanzpoliert, für Kaffeesahne, mit Griff, Inhalt à 25 ml

mirror polished, for coffee-cream, with handle, capacity à 25 ml

pulido brillante, para crema de café, con asa, capacidad 25 ml

poli brillant, avec anse, 25 ml



| | Ø cm | ↑ cm | pcs. | ltr. |
|-------|------|------|------|-------|
| 10321 | 3,5 | 3,5 | 4 | 0,025 |

**Mini-Milchkanne „SNACKHOLDER“ 4er Set**

mini milk can, 4 pcs.
lechera en formato mini, set de 4
pot à lait mini, set de 4



| | Ø cm | ↑ cm | ltr. | pcs. |
|-------|------|------|------|------|
| 40640 | 4,5 | 5 | 0,08 | 4 |



NEW

5-tlg.
5 pcs.**Milch- und Zucker-Set**

bowl
cuenco
bol

5-teilig: Tablett, Milchkanne, Zuckerdose mit Deckel, Löffel, Akazienholz, Edelstahl PTFE beschichtet, schwarz

5 pcs.: tray, milk jug, sugar bowl with lid, spoon, acacia wood, stainless inox PTFE coated, black

set de 5: bandeja, jarra de leche, azucarero con tapa, cuchara, madera de acacia, acero inoxidable revestimiento PTFE, negro

set de 5: plateau, pichet à lait, sucrier avec couvercle, cuillère, bois d'acacia, acier inox revêtement PTFE, noir



| | cm | ↑ cm |
|-------|---------|------|
| 00634 | 19 x 10 | 10,5 |



Butterservierer
butter dish
mantequillera
beurrer



| | cm | ↑ cm | ltr. |
|-------|-------|------|-------|
| 15925 | Ø 9 | 9 | 0,07 |
| 15926 | 9 x 9 | 9 | 0,075 |



Butterservierer
butter dish
mantequillera
beurrer



hochglanzpoliert
mirror polished
acabado brillante
poli brillant

| | Ø cm | ↑ cm | ltr. |
|-------|------|------|------|
| 15921 | 9 | 7 | 0,06 |



Schale „ENAMELWARE“
bowl
cuenco
bol



| | cm | ↑ cm | ltr. |
|-------|-----------|------|------|
| 40667 | 16 x 12,0 | 3,5 | 0,20 |
| 40668 | 18 x 13,5 | 4,0 | 0,35 |



Kühlschrank-Butterdose
refrigerator butter dish
mantequillera para nevera
boîte à beurre pour le frigo



| | cm | ↑ cm |
|-------|----------|------|
| 00063 | 16 x 9,5 | 5,5 |



Eierbecher
egg holder
huevera
coquetier



| | Ø cm | ↑ cm |
|-------|------|------|
| 00032 | 8,5 | 2 |



2,2 ltr.

65060

Fondue und Feuerzangenbowle-Set „TWO IN ONE“

fondue and fire punch bowl set
set para fondue o ponche caliente
service à fondue et à punch



13-teiliges Set aus Edelstahl bestehend aus:

1 Topf, 1 Rechaud, 1 Spritzschutz, 1 Untersetzer, 1 Schöpfkelle, 1 Feuerzange,
1 Pastenbrenner, 6 Fonduegabeln

13-piece stainless steel set consisting of:

1 pot, 1 rechaud, 1 splash guard, 1 coaster, 1 ladle, 1 fire tongs,
1 paste burner, 6 fondue forks

set de 13 piezas de acero inoxidable compuesto por:

1 olla, 1 rechaud, 1 protector contra salpicaduras, 1 trébede, 1 cazo,
1 pinza para el fuego, 1 quemador de pasta, 6 tenedores de fondue

set de 13 pièces en acier inox comprenant:

1 marmite, 1 rechaud, 1 pare-éclaboussures, 1 dessous de plat, 1 louche, 1 pince à feu,
1 brûleur à pâte, 6 fourchettes à fondue

| | Ø cm | ↑ cm | ltr. |
|-------|------|------|------|
| 65060 | 22 | 23 | 2,2 |



Kaviarkühler

caviar cooler
enfriador de caviar
rafraîchisseur de caviar



4-teilig: Glasschale Ø 10 cm / 4 pcs.: glass bowl Ø 10 cm / set de 4: bol Ø 10 cm
set de 4: bol Ø 10 cm

| | Ø cm | ↑ cm |
|-------|------|------|
| 01699 | 18 | 12 |

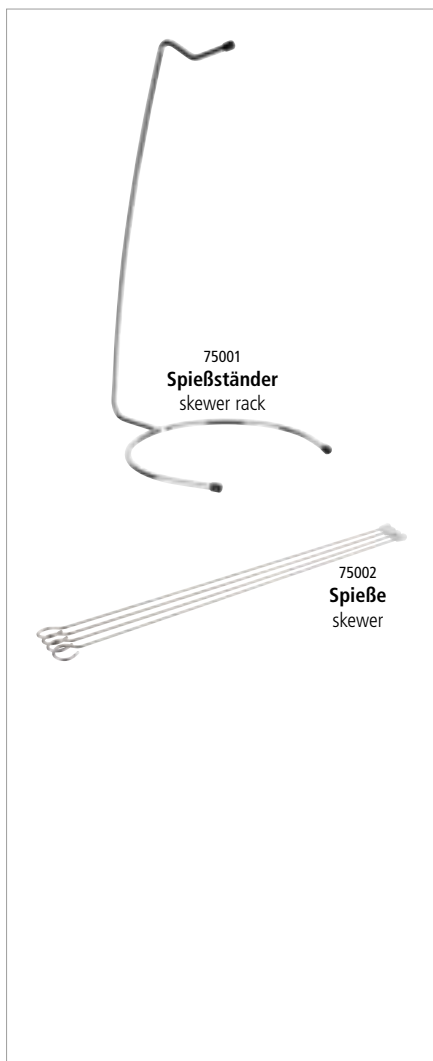

75001

Spießständer
skewer rack

75002

Spieße
skewer

Spießständer

espetada and kebab skewer rack
soporte para brochetas
support pour brochettes



zum Servieren von Fleischspießen bis 40 cm, Gestell aus 8 mm Edelstahl, ohne Spieße

to serve skewers up to 40 cm, wire stainless steel 8 mm, without skewer

para servir brochetas de carne hasta 40 cm, grosor del alambre 8 mm, sin brochetas

pour présenter les brochettes long. maxi 40 cm, fil 8 mm, sans brochettes

| | Ø cm | ↑ cm |
|-------|------|------|
| 75001 | 22,0 | 46 |

Spieße, 4er Set

skewer, 4 pcs.
brochetas, set de 4
brochettes, set de 4



4er Set, offener Haken, Ende spitz, passend zu 75001

4 pcs., open hook, pointed end, suitable for 75001

set de 4, gancho abierto, extremo puntiagudo, apto para 75001

set de 4, crochet ouvert, extrémité pointue, convient pour 75001

| | Ø cm | ↑ cm | pcs. |
|-------|------|------|------|
| 75002 | 0,3 | 40 | 4 |



75001

Spießständer
skewer rack

75002

Spieße
skewer

Präsentationsmöglichkeit
presentation example

TABLE CADDYS



Table Caddy „ELEMENT“

table caddy
caddy de mesa
caddy de table



Beton, möbelschonende Unterseite, 1 Fach: 14,5 x 14 cm

concrete, furniture-friendly underside, 1 compartment: 14,5 x 14 cm

hormigón, base anti rayaduras, 1 compartimento: 14,5 x 14 cm

béton, revêtement antirayures, 1 compartiment: 14,5 x 14 cm

| | cm | ↑ cm |
|-------|-----------|------|
| 11647 | 16,5 x 16 | 6,5 |



Table Caddy „ELEMENT“

table caddy
caddy de mesa
caddy de table



Beton, möbelschonende Unterseite, 1 Fach: 14,5 x 14 cm, 2 Löcher je 6,5 cm

concrete, furniture-friendly underside, 1 compartment: 14,5 x 14 cm, 2 holes each 6.5 cm

hormigón, base anti rayaduras, 1 compartimento: 14,5 x 14 cm, 2 agujeros cada uno 6,5 cm

béton, revêtement antirayures, 1 compartiment: 14,5 x 14 cm, 2 trous de 6,5 cm chacun

| | cm | ↑ cm | inner size cm |
|-------|-----------|------|---------------|
| 11648 | 23,5 x 16 | 6,5 | 14,5 x 14 |



Table Caddy

table caddy
caddy de mesa
caddy de table



Akazienholz, 2-Fächer: 21,5 x 8 cm

acacia wood, 2 compartements: 21,5 x 8 cm

madera de acacia, 2 compartimentos: 21,5 x 8 cm

bois d'acacia, 2 compartiments : 21,5 x 8 cm

| | cm | ↑ cm |
|-------|---------|------|
| 40405 | 25 x 15 | 18 |



Table Caddy „VINTAGE“

table caddy
caddy de mesa
caddy de table



Tannenzholz, 2 Fächer: 13,5 x 6 cm

fir wood, 2 compartments: 13,5 x 6 cm

madera de abeto, 2 compartimentos: 13,5 x 6 cm

bois de sapin, 2 compartiments : 13,5 x 6 cm

| | cm | ↑ cm |
|-------|-------------|------|
| 40404 | 15,5 x 15,5 | 15 |



Holzbox „WOODY“

woodbox
caja madera
base bois



Akazienholz, 4-Fächer: 12,5 x 8 cm

acacia wood, 4 compartements: 12,5 x 8 cm

madera de acacia, 4 compartimentos: 12,5 x 8 cm

bois d'acacia, 4 compartiments : 12,5 x 8 cm

| | cm | ↑ cm |
|-------|---------|------|
| 11649 | 36 x 14 | 12,5 |

**Holzbox „TABLE“**

woodbox
caja madera
base bois



Akazienholz, 3 Fächer: 6,5 x 6,5 cm

acacia wood, 3 compartments: 6,5 x 6,5 cm
madera de acacia, 3 compartimentos: 6,5 x 6,5 cm
bois d'acacia, 3 compartiments : 6,5 x 6,5 cm

| | cm | ↑ cm |
|-------|------------|------|
| 11727 | 23,5 x 8,5 | 4,5 |

Holzbox „TABLE“

woodbox
caja madera
base bois



Akazienholz, 1 Fach: 12 x 6,5 cm

acacia wood, 1 compartment: 12 x 6,5 cm
madera de acacia, 1 compartimento: 12 x 6,5 cm
bois d'acacia, 1 compartiment: 12 x 6,5 cm

| | cm | ↑ cm |
|-------|------------|------|
| 11726 | 15,0 x 9,5 | 5 |

**Table Caddy**

table caddy
caddy de mesa
caddy de table



Akazienholz, 1 Fach: 21,5 x 8 cm

acacia wood, 1 compartment: 21,5 x 8 cm
madera de acacia, 1 compartimento: 21,5 x 8 cm
bois d'acacia, 1 compartiment: 21,5 x 8 cm

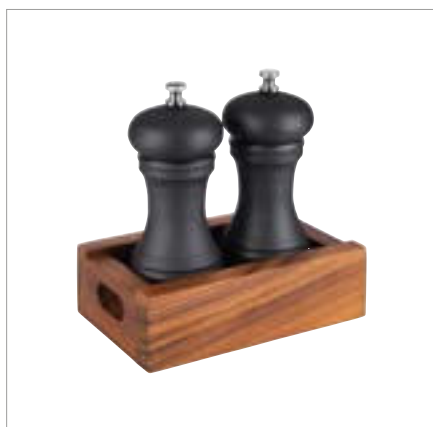
| | cm | ↑ cm |
|-------|---------|------|
| 11625 | 23 x 10 | 10 |

**Holzbox „WOODY“**

woodbox
caja madera
base bois



Akazienholz, 1 Fach: 13 x 13 cm

acacia wood, 1 compartment: 13 x 13 cm
madera de acacia, 1 compartimento: 13 x 13 cm
bois d'acacia, 1 compartiment : 13 x 13 cm

| | cm | ↑ cm |
|-------|-----------|------|
| 11650 | 15,0 x 15 | 5,5 |

Akazienholz, 2 Fächer: 13,5 x 13 cm / 6,5 x 13 cm

acacia wood, 2 compartments: 13,5 x 13 cm / 6,5 x 13 cm
madera de acacia, 2 compartimentos: 13,5 x 13 cm / 6,5 x 13 cm
bois d'acacia, 2 compartiments : 13,5 x 13 cm / 6,5 x 13 cm

| | cm | ↑ cm |
|-------|-----------|------|
| 11651 | 22,5 x 15 | 5,5 |



CANDLE HOLDERS



Kerzenleuchter

candle holder
candelabro
chandelier



extra schwerer Fuß, verchromt, möbelschonende Unterseite

heavy foot, chrome plated, furniture-friendly underside

pie pesado, asa cromado, base anti rayaduras

pied lourd, chromé, revêtement antirayures

| | Ø cm | ↑ cm | Farbe / Colour |
|-------|------|------|----------------|
| 04020 | 10 | 11 | — |
| 04021 | 10 | 16 | — |



Windlichter „ELEMENT“, 2er Set

wind lights, 2 pcs.

portavelas antiviento, set de 2

porte-bougies anti-vent, set de 2



Beton, Gläser klar, möbelschonende Unterseite

concrete, glass clear, furniture-friendly underside

hormigón, vidrio transparente, base anti rayaduras

béton, verre transparente, revêtement antirayures

| | Ø cm | ↑ cm | pcs. |
|-------|------|------|------|
| 03038 | 6 | 8 | 2 |

Ersatzglas / spare glass / vidrio de recambio solo / verre de rechange transparent, seul

| | Ø cm | ↑ cm |
|-------|------|------|
| 03098 | 6 | 5 |



Windlicht „ELEMENT“

wind light

porta vela

porte-bougie



Beton, Glas klar, möbelschonende Unterseite

concrete, glass clear, furniture-friendly underside

hormigón, vidrio transparente, base anti rayaduras

béton, verre transparente, revêtement antirayures

| | Ø cm | ↑ cm |
|-------|------|------|
| 03039 | 7,5 | 13 |

Ersatzglas / spare glass / vidrio de recambio solo / verre de rechange transparent, seul

| | Ø cm | ↑ cm |
|-------|------|------|
| 03099 | 7,5 | 9 |



Vase mit Glaseinsatz „ELEMENT“

flower vase with glass insert
florero con tubo de cristal
vase soliflor avec verre



Beton, Glas klar, möbelschonende Unterseite, inkl. 2 Ersatzgläsern

concrete, clear glass, furniture-friendly underside, incl. 2 spare glasses
hormigón, cristal incoloro, base anti rayaduras, incl. 2 tubos de repuesto
béton, verre transparente revêtement antirayures y compris 2 verres de rechange

| | cm | ↑ cm | ml |
|-------|----------|------|----|
| 04010 | 10 x 4,5 | 12,5 | 25 |



Ersatzglas / spare glass / tubo de recambio / verre de rechange

| | Ø cm | ↑ cm | ml |
|-------|------|------|----|
| 04011 | 2,5 | 11 | 25 |



Vase

flower vase
florero
vase soliflor



Edelstahl-Look, Zinkdruckguss, vernickelt, lackiert, anlaufgeschützt, schwere Ausführung
stainless steel look, heavy zink alloy, nickel plated, laquered
aspecto acero, acabado satinado, alta calidad
aspect inox, fini poli mat, bonne qualité

| | Ø cm | ↑ cm | kg |
|-------|------|------|------|
| 04015 | 4,0 | 16,5 | 0,17 |



Vase

flower vase
florero
vase soliflor



Edelstahl-Look, Zinkdruckguss, vernickelt, lackiert, anlaufgeschützt, schwere Ausführung
stainless steel look, heavy zink alloy, nickel plated, laquered
aspecto acero, acabado satinado, alta calidad
aspect inox, fini poli mat, bonne qualité

| | Ø cm | ↑ cm | kg |
|-------|------|------|------|
| 04017 | 6,5 | 18 | 0,36 |



PLACEMATS

Die umgelegten und angenähten Kanten machen diese Tischsets besonders robust. Geliefert in einer 6er Einheit.

The folded and sewn edges make these table sets particularly robust. Delivered in a packing unit of 6 pieces.

Los bordes doblados y cosidos des los mantelitos los hacen especialmente resistentes. Se entregan en una unidad de embalaje de 6 piezas.

Les bords repliés et cousus rendent ces sets de table en particulierement robustes. Livré dans un emballage de 6 pièces.



Warenträger - Tischsets

display for placemats
expositor para mantelinas de mesa
présentoir pour sets de table

12 Einschubfächer, komplett auf Rollen, 2 Feststellrollen, Lieferung demontiert

12 shelves, on rolls, 2 rolls to fix, delivery unassembled

12 niveles, 4 ruedas, desmontado (montaje fácil)

12 niveaux, 4 roues, livré démonté

| | cm | ↑ cm |
|-------|-----------|------|
| 00401 | 39,5 x 45 | 165 |

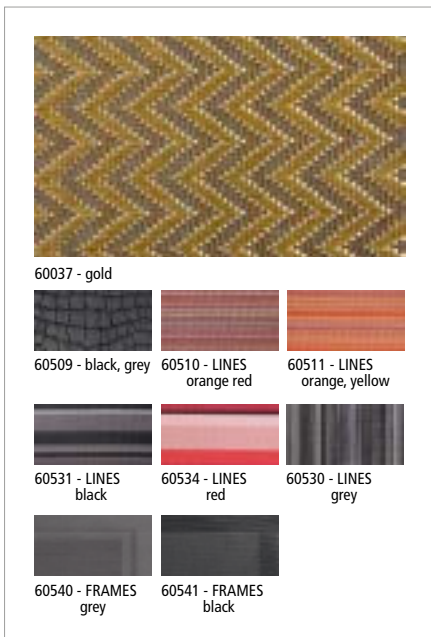

Tischset Feinband

placemat fine band
mantelín cinta fina
set de table, tressage fin



| | cm | | VE / unit |
|-------|---------|--|-----------|
| 60037 | 45 x 33 | gold / gold | 6 |
| 60509 | 45 x 33 | Mosaik schwarz, grau / black, grey | 6 |
| 60510 | 45 x 33 | LINES orange, rot / LINES orange red | 6 |
| 60511 | 45 x 33 | LINES orange, gelb / LINES orange yellow | 6 |
| 60531 | 45 x 33 | LINES schwarz / LINES black | 6 |
| 60534 | 45 x 33 | LINES rot / LINES red | 6 |
| 60530 | 45 x 33 | STRIPES grau / STRIPES grey | 6 |
| 60540 | 45 x 33 | FRAMES grau / FRAMES grey | 6 |
| 60541 | 45 x 33 | FRAMES schwarz / FRAMES black | 6 |

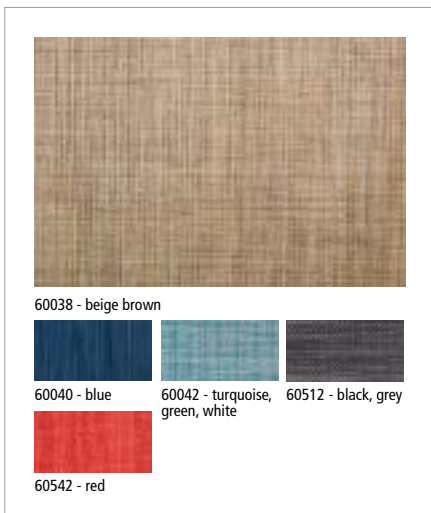

Tischset Feinband

placemat fine band
mantelín cinta fina
set de table, tressage fin



| | cm | | VE / unit |
|-------|---------|--|-----------|
| 60038 | 45 x 33 | beige braun / beige brown | 6 |
| 60040 | 45 x 33 | blau / blue | 6 |
| 60042 | 45 x 33 | türkis, grün, weiß / turquoise, green, white | 6 |
| 60512 | 45 x 33 | schwarz, grau / black, grey | 6 |
| 60542 | 45 x 33 | rot / red | 6 |



60502 - grey, beige



60503 - beige 60505 - brown 60508 - blue

Tischset Feinband „TAO“
 placemat fine band
 mantelín cinta fina
 set de table, tressage fin



| | cm | | VE / unit |
|-------|---------|--|-----------|
| 60502 | 45 x 33 | grau, beige / grey, beige | 6 |
| 60503 | 45 x 33 | beige / beige | 6 |
| 60505 | 45 x 33 | braun / brown | 6 |
| 60508 | 45 x 33 | hellblau, dunkelblau / light blue, dark blue | 6 |



60002 - light blue



60018 - candyred 60012 - black 60014 - beige
 60015 - silbergrey 60016 - green 60019 - beige brown
 60522 - light orange 60520 - black/white 60521 - apple green
 60523 - purple 60524 - platinum 60041 - light blue, white
 60525 - white 60526 - gold 60527 - silver
 60528 - green

Tischset Schmalband
 placemat smallband
 mantelín cinta estrecha
 set de table tressage étroit



| | cm | | VE / unit |
|-------|---------|------------------------------------|-----------|
| 60002 | 45 x 33 | hellblau / light blue | 6 |
| 60018 | 45 x 33 | candyrot / candyred | 6 |
| 60012 | 45 x 33 | schwarz / black | 6 |
| 60014 | 45 x 33 | beige / beige | 6 |
| 60015 | 45 x 33 | silbergrau / silbergrey | 6 |
| 60016 | 45 x 33 | grün / green | 6 |
| 60019 | 45 x 33 | beige braun / beige brown | 6 |
| 60522 | 45 x 33 | hellorange / light orange | 6 |
| 60520 | 45 x 33 | schwarz weiß / black white | 6 |
| 60521 | 45 x 33 | apfelgrün / apple green | 6 |
| 60523 | 45 x 33 | violett / purple | 6 |
| 60524 | 45 x 33 | platin / platinum | 6 |
| 60041 | 45 x 33 | hellblau, weiß / light blue, white | 6 |
| 60525 | 45 x 33 | weiß / white | 6 |
| 60526 | 45 x 33 | gold / gold | 6 |
| 60527 | 45 x 33 | silber / silver | 6 |
| 60528 | 45 x 33 | grün / green | 6 |



60551



60551 - silbergrau / silbergrey 60552 - beige / braun 60554 - platin

Servietten- und Bestecktaschen, 6er Set
 cutlery bag, 6 pcs. set
 bolsa cubiertos, set de 6
 pochette couverts, set de 6



| | cm | | pcs. |
|-------|--------|---------------------------|------|
| 60551 | 24 x 9 | silbergrau / silbergrey | 6 |
| 60552 | 24 x 9 | beige braun / beige brown | 6 |
| 60554 | 24 x 9 | platin / platinum | 6 |

PLACEMATS



Tischset placemat mantelín set de table



Kunstleder, mit Naht rundherum

imitation leather, with seam all around
imitación de cuero, con costura alrededor
similicuir, avec couture tout autour

| | cm | | VE / unit |
|-------|-----------|-----------------|-----------|
| 60044 | 45 x 32,5 | grau / grey | 6 |
| 60045 | 45 x 32,5 | braun / brown | 6 |
| 60046 | 45 x 32,5 | schwarz / black | 6 |



Tischset placemat mantelín set de table



rutschhemmende Unterseite

slip resistant underside
antideslizante por debajo
dessous antiglisse

| | cm | | VE / unit |
|-------|---------|-----------------|-----------|
| 60543 | 45 x 30 | silber / silver | 6 |



Tischset „PURE“ placemat mantelín set de table



rutschhemmende Unterseite

slip resistant underside
antideslizante por debajo
dessous antiglisse

| | cm | | VE / unit |
|-------|---------|-------------------------------|-----------|
| 60544 | 45 x 30 | sand / sand | 6 |
| 60545 | 45 x 30 | bronze/schwarz / bronze/black | 6 |
| 60546 | 45 x 30 | bron/schwarz / silver/black | 6 |



Tischset „CROCO“ placemat mantelín set de table



rutschhemmende Unterseite

slip resistant underside
antideslizante por debajo
dessous antiglisse

| | cm | | VE / unit |
|-------|---------|-----------------|-----------|
| 60535 | 45 x 30 | gold / gold | 6 |
| 60536 | 45 x 30 | kupfer / copper | 6 |
| 60537 | 45 x 30 | braun / brown | 6 |

ENAMELWARE



Teller, flach „ENAMELWARE“

plate, flat
plato, plano
assiette, plat



| | Ø cm | ↑ cm | Farbe / Colour |
|-------|------|------|----------------|
| 40664 | 20 | 2 | |
| 40665 | 24 | 2 | |
| 40666 | 26 | 2 | |



Teller, tief „ENAMELWARE“

plate, deep
plato, profunda
assiette, profonde



| | Ø cm | ↑ cm | ltr. | Farbe / Colour |
|-------|------|------|------|----------------|
| 40661 | 18 | 3,5 | 0,35 | |
| 40662 | 22 | 3,5 | 0,60 | |
| 40663 | 24 | 3,5 | 0,85 | |



Schale „ENAMELWARE“

bowl
cuenco
bol



| | cm | ↑ cm | ltr. | Farbe / Colour |
|-------|-----------|------|------|----------------|
| 40667 | 16 x 12,0 | 3,5 | 0,20 | |
| 40668 | 18 x 13,5 | 4,0 | 0,35 | |



Schale „ENAMELWARE“

bowl
cuenco
bol



| | cm | ↑ cm | ltr. | Farbe / Colour |
|-------|---------|------|------|----------------|
| 40669 | 28 x 23 | 4,5 | 1,9 | |

ENAMELWARE



Henkelbecher „ENAMELWARE“

beaker
vaso coctelero
bol mélangeur



| | Ø cm | ↑ cm | ltr. | Farbe / Colour |
|-------|------|------|------|----------------|
| 40636 | 7 | 5 | 0,10 | White/Blue |
| 40632 | 9 | 8 | 0,35 | White/Blue |
| 40637 | 10 | 9 | 0,50 | White/Blue |



Henkelbecher „ENAMELWARE“

beaker
vaso coctelero
bol mélangeur



| | Ø cm | ↑ cm | ltr. | Farbe / Colour |
|-------|------|------|------|----------------|
| 40633 | 9 | 8 | 0,35 | Red/Black |



Henkelbecher „ENAMELWARE“

beaker
vaso coctelero
bol mélangeur



| | Ø cm | ↑ cm | ltr. | Farbe / Colour |
|-------|------|------|------|----------------|
| 40634 | 9 | 8 | 0,35 | Green/Black |



Henkelbecher „ENAMELWARE“

beaker
vaso coctelero
bol mélangeur



| | Ø cm | ↑ cm | ltr. | Farbe / Colour |
|-------|------|------|------|----------------|
| 40635 | 9 | 8 | 0,35 | Blue/Black |



Schale „ENAMELWARE“

bowl
cuenco
bol



| | Ø cm | ↑ cm | ltr. | Farbe / Colour |
|-------|------|------|------|----------------|
| 40645 | 7,0 | 4,5 | 0,08 | White/Blue |
| 40646 | 8,0 | 3,5 | 0,08 | White/Blue |
| 40638 | 13,0 | 6,0 | 0,50 | White/Blue |
| 40647 | 16,5 | 4,5 | 0,45 | White/Blue |

Original WECK



Weck-Flaschen, 6er Set

Weck-bottles, 6 pcs.
Weck-botellas, set de 6
Weck-bouteilles, set de 6



6 Flaschen + 6 Deckel, ideal zum Servieren von Saft, Smoothie, Dressing und Saucen
6 bottles + 6 covers, ideal for serving juice, smoothie, dressing and sauces
6 botellas + 6 tapas, ideal para servir zumo, licuado, aliño y salsas
6 bouteilles + 6 couvercles, idéal pour servir de jus, smoothie, vinaigrette et sauces

| | Ø cm | ↑ cm | ltr. | pcs |
|-------|------|------|------|-----|
| 82307 | 6 | 14,5 | 0,25 | 6 |



Weck-Flaschen, 6er Set

Weck-bottles, 6 pcs.
Weck-botellas, set de 6
Weck-bouteilles, set de 6



6 Flaschen + 6 Deckel, ideal zum Servieren von Saft, Smoothie, Dressing und Saucen
6 bottles + 6 covers, ideal for serving juice, smoothie, dressing and sauces
6 botellas + 6 tapas, ideal para servir zumo, licuado, aliño y salsas
6 bouteilles + 6 couvercles, idéal pour servir de jus, smoothie, vinaigrette et sauces

| | Ø cm | ↑ cm | ltr. | pcs |
|-------|------|------|------|-----|
| 82308 | 6 | 19 | 0,5 | 6 |



Weck-Flaschen, 6er Set

Weck-bottles, 6 pcs.
Weck-botellas, set de 6
Weck-bouteilles, set de 6



6 Flaschen + 6 Deckel, ideal zum Servieren von Saft, Smoothie, Dressing und Saucen
6 bottles + 6 covers, ideal for serving juice, smoothie, dressing and sauces
6 botellas + 6 tapas, ideal para servir zumo, licuado, aliño y salsas
6 bouteilles + 6 couvercles, idéal pour servir de jus, smoothie, vinaigrette et sauces

| | Ø cm | ↑ cm | ltr. | pcs |
|-------|------|------|------|-----|
| 82309 | 6 | 25,5 | 1,0 | 6 |

GLASSES



Weck-Gläser mit Deckel, 2er Set

Weck-glasses with lid, 2 pcs.
Weck tarros de vidrio con tapa, set de 2
Weck verrines avec couvercle, set de 2

2 Gläser + 2 Edelstahldeckel

2 glasses + 2 stainless steel lids

2 tarros + 2 tapas de acero inoxidable

2 verrines + 2 couvercles en acier inox



| | Ø cm | ↑ cm | ltr. | pcs |
|-------|------|------|------|-----|
| 82239 | 11 | 7,5 | 0,37 | 2 |
| 82240 | 11 | 11 | 0,58 | 2 |



Edelstahldeckel für Weck-Gläser

stainless steel lid for Weck-glasses
tapas de acero inoxidable por Weck tarros
couvercles en acier inox pour Weck verrines



| | Ø cm | ↑ cm | |
|-------|------|------|----------------------------|
| 82360 | 10,5 | 2 | 82239, 82240, 82346, 82347 |



Weck-Gläser mit Deckel, 2er Set

Weck-glasses with lid, 2 pcs.
Weck tarros de vidrio con tapa, set de 2
Weck verrines avec couvercle, set de 2

2 Gläser + 2 klappbare Edelstahldeckel

2 glasses + 2 foldable stainless steel lids

2 tarros + 2 tapas plegables de acero inoxidable

2 verrines + 2 couvercles pliables en acier inox



| | Ø cm | ↑ cm | ltr. | pcs |
|-------|------|------|------|-----|
| 82241 | 11 | 7,5 | 0,37 | 2 |
| 82242 | 11 | 11 | 0,58 | 2 |



klappbarer Edelstahldeckel für Weck-Gläser

foldable stainless steel lid for Weck-glasses
tapa plegable de acero inoxidable por Weck tarros
couvercle pliable en acier inox pour Weck verrines



| | Ø cm | ↑ cm | |
|-------|------|------|----------------------------|
| 82361 | 10,5 | 4,5 | 82241, 82242, 82346, 82347 |

**Weck-Gläser mit Deckel, 2er Set**

Weck-glasses with lid, 2 pcs.

Weck tarros de vidrio con tapa, set de 2

Weck verrines avec couvercle, set de 2

2 Gläser + 2 Deckel aus Buchenholz

2 glasses + 2 beech wood lids

2 tarros + 2 tapas de madera de haya

2 verrines + 2 couvercles en bois de hêtre



| | Ø cm | ↑ cm | ltr. | pcs |
|-------|------|------|------|-----|
| 82243 | 11 | 7,5 | 0,37 | 2 |
| 82244 | 11 | 11 | 0,58 | 2 |

**Holzdeckel für Weck-Gläser**

wooden lid for Weck-glasses

tapas de madera por Weck tarros

couvercles en bois pour Weck verrines



| | Ø cm | ↑ cm | fits to |
|-------|------|------|----------------------------|
| 82362 | 11 | 2 | 82243, 82244, 82346, 82347 |

**Weck-Gläser mit Deckel, 12er Set**

Weck-glasses with lid, 12 pcs.

Weck tarros de vidrio con tapa, set de 12

Weck verrines avec couvercle, set de 12

12 Gläser + 12 Deckel aus Buchenholz

12 glasses + 12 beech wood lids

12 tarros + 12 tapas de madera de haya

12 verrines + 12 couvercles en bois de hêtre



| | Ø cm | ↑ cm | ltr. | pcs. |
|-------|------|------|------|------|
| 82245 | 6 | 7 | 0,14 | 12 |

**Weck-Gläser mit Deckel, 12er Set**

Weck-glasses with lid, 12 pcs.

Weck tarros de vidrio con tapa, set de 12

Weck verrines avec couvercle, set de 12

12 Gläser + 12 Deckel aus Buchenholz

12 glasses + 12 beech wood lids

12 tarros + 12 tapas de madera de haya

12 verrines + 12 couvercles en bois de hêtre



| | Ø cm | ↑ cm | ltr. | pcs. |
|-------|------|------|------|------|
| 82246 | 7 | 8 | 0,22 | 12 |

**Holzdeckel für Weck-Gläser, 12er Set**

wooden lid for Weck-glasses, 12 pcs.

tapas de madera por Weck tarros, set de 12

couvercles en bois pour Weck verrines, set de 12



| | Ø cm | ↑ cm | fits to | pcs. |
|-------|------|------|---|------|
| 82363 | 7 | 1,5 | 82245, 82246, 82307, 82308, 82309, 82310, 82312, 82314, 82316, 82370, 82371 | 12 |

GLASSES



82310 80 ml

82314 160 ml

82345 200 ml

Weck-Gläser mit Deckel, 12er Set

Weck-glasses with lid, 12 pcs.
Weck tarros de vidrio con tapa, set de 12
Weck verrines avec couvercle, set de 12

12 Gläser + 12 Deckel

12 glasses + 12 covers

12 vasos + 12 tapas

12 verrines + 12 couvercles



| | Ø cm | ↑ cm | ltr. | pcs |
|-------|------|------|------|-----|
| 82310 | 6 | 5,5 | 0,08 | 12 |
| 82312 | 6 | 7,0 | 0,14 | 12 |
| 82314 | 6 | 8,0 | 0,16 | 12 |
| 82345 | 9 | 6 | 0,20 | 12 |

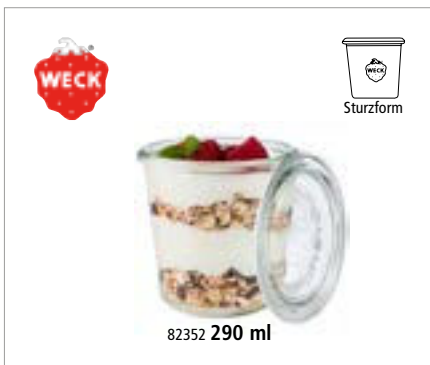

82352 290 ml

Weck-Gläser mit Deckel, 6er Set

Weck-glasses with lid, 6 pcs.
Weck tarros de vidrio con tapa, set de 6
Weck verrines avec couvercle, set de 6

6 Gläser + 6 Deckel

6 glasses + 6 covers

6 tarros + 6 tapas

6 verrines + 6 couvercles



| | Ø cm | ↑ cm | ltr. | pcs |
|-------|------|------|------|-----|
| 82352 | 9 | 9 | 0,29 | 6 |



82346 370 ml

Weck-Gläser mit Deckel, 3er Set

Weck-glasses with lid, 3 pcs.
Weck tarros de vidrio con tapa, set de 3
Weck verrines avec couvercle, set de 3

3 Gläser + 3 Deckel

3 glasses + 3 covers

3 vasos + 3 tapas

3 verrines + 3 couvercles



| | Ø cm | ↑ cm | ltr. | pcs |
|-------|------|------|------|-----|
| 82346 | 11 | 7,5 | 0,37 | 3 |



82347 580 ml

Weck-Gläser mit Deckel, 2er Set

Weck-glasses with lid, 2 pcs.
Weck tarros de vidrio con tapa, set de 2
Weck verrines avec couvercle, set de 2

2 Gläser + 2 Deckel

2 glasses + 2 covers

2 vasos + 2 tapas

2 verrines + 2 couvercles

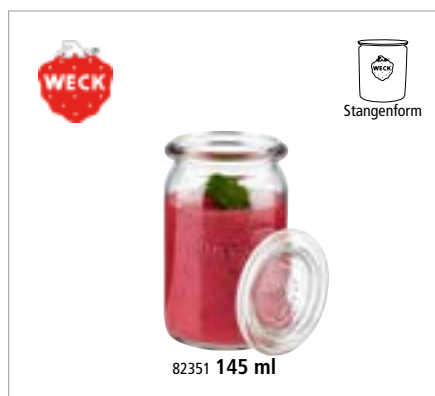

| | Ø cm | ↑ cm | ltr. | pcs |
|-------|------|------|------|-----|
| 82347 | 11 | 11 | 0,58 | 2 |

**Weck-Gläser mit Deckel, 12er Set**

Weck-glasses with lid, 12 pcs.
Weck tarros de vidrio con tapa, set de 12
Weck verrines avec couvercle, set de 12

12 Gläser + 12 Deckel

12 glasses + 12 covers
12 tarros + 12 tapas
12 verrines + 12 couvercles

| | Ø cm | ↑ cm | ltr. | pcs |
|-------|------|------|-------|-----|
| 82351 | 5,5 | 9 | 0,145 | 12 |

**Weck-Gläser mit Deckel, 12er Set**

Weck-glasses with lid, 12 pcs.
Weck tarros de vidrio con tapa, set de 12
Weck verrines avec couvercle, set de 12

12 Gläser + 12 Deckel

12 glasses + 12 covers
12 vasos + 12 tapas
12 verrines + 12 couvercles

| | Ø cm | ↑ cm | ltr. | pcs |
|-------|------|------|-------|-----|
| 82350 | 5,5 | 6 | 0,075 | 12 |
| 82316 | 7 | 8,0 | 0,22 | 12 |

**Weck-Gläser mit Deckel, 6er Set**

Weck-glasses with lid, 6 pcs.
Weck tarros de vidrio con tapa, set de 6
Weck verrines avec couvercle, set de 6

6 Gläser + 6 Deckel

6 glasses + 6 covers
6 tarros + 6 tapas
6 verrines + 6 couvercles

| | Ø cm | ↑ cm | ltr. | pcs |
|-------|------|------|------|-----|
| 82354 | 11 | 9 | 0,58 | 6 |

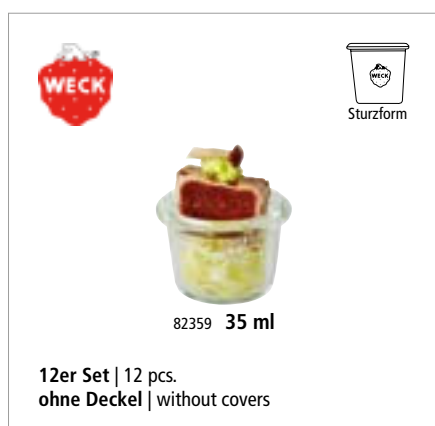
**Gourmetgläser, 12er Set**

gourmet glasses, 12 pcs.
tarros gourmet, set de 12
verres gourmet, set de 12

| | Ø cm | ↑ cm | ltr. | pcs |
|-------|------|------|-------|-----|
| 82359 | 5 | 3,5 | 0,035 | 12 |
| 82370 | 6 | 5,5 | 0,08 | 12 |
| 82371 | 6 | 8,0 | 0,16 | 12 |





Serviergestell „WECK“

serving stand
expositor
présentoir
ohne Gläser
without glasses
sin vasos
sans verrines



| | Ø cm | ↑ cm | |
|-------|------|------|-------------|
| 33246 | 22 | 59 | 12 x Ø 6 cm |

passende Gläser / matching glasses / vasos a juego / verrines approprié



| | Ø cm | ↑ cm | ltr. | pcs |
|-------|------|------|------|-----|
| 82310 | 6 | 5,5 | 0,08 | 12 |
| 82312 | 6 | 7,0 | 0,14 | 12 |
| 82314 | 6 | 8,0 | 0,16 | 12 |



Weck-Frischhaltedeckel, 5er Set

airtight cover, 5 pcs.
tapa hermética, set de 5
couvercle hermétique, set de 5
für Rundrandgläser Ø 6 cm, 5er Set
for Ø 6 cm glasses, 5 pcs. set
para vasos Ø 6 cm, set de 5
pour verrines Ø 6 cm, set de 5



| | Ø cm | pcs. |
|-------|------|------|
| 82338 | 7 | 5 |



Gummidichtringe, 10er Set

rubber washer, 10 pcs.
juntas de goma, set de 10
joints de caoutchouc, set de 10
für Deckel der Weck-Gläser, im Beutel verpackt

for covers of Weck-glasses, packed in a bag
para las tapas de los tarritos Weck, empaquetado en una bolsa
pour la fermeture des verrines Weck, emballé dans un sac

| | fits to | pcs. |
|-------|---|------|
| 82318 | 82307, 82308, 82309, 82310, 82312, 82314, 82316 | 10 |
| 82394 | 82345 | 10 |
| 82395 | 82346, 82347 | 10 |



8er Set Deckel-Klammer für 4 Weck-Gläser

8 pcs. cover clamps for 4 Weck-glasses
8 abrazaderas para 4 vasitos Weck
8 agrafes pour 4 verrines Weck

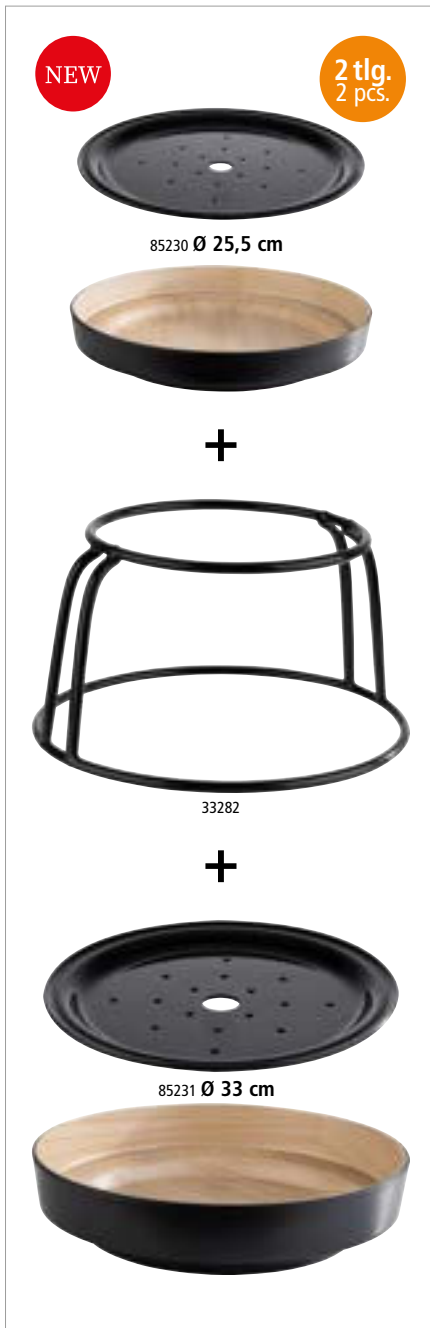

| | pcs. |
|-------|------|
| 82319 | 8 |

**Schale, 2-teilig „FRIDA“**

bowl, 2 pcs.
cuenca, set de 2
bol, set de 2



inklusive Abtropfeinsatz
including drip tray
con bandeja recogegotas
avec égouttoir

| | Ø cm | ↑ cm |
|-------|------|------|
| 85230 | 25,5 | 6 |
| 85231 | 33,0 | 6 |

Buffetständer

buffet stand
soporte para buffet
présentoir buffet



Metall, mit schwarzer Antirutschbeschichtung, für Schalen Nr. 85230, 85231
metal, with black anti-slide coating, for bowls no. 85230, 85231
metal, con revestimiento antideslizante negro, para cuencos 85230, 85231
métal, avec revêtement antidérapant noir, pour bols 85230, 85231

| | Ø cm | ↑ cm |
|-------|-----------|------|
| 33282 | 23 / 30,5 | 17 |



Präsentationsmöglichkeit
presentation example



mit Abtropfeinsatz
with drip tray

**Servier-Muscheltopf**

serving mussel pot
mejillonera para servir
casserole à moules pour servir

schwarz emailliertes Stahlblech, mit Edelstahlrand
black enamelled steel, stainless steel rim
hierro esmaltado negro, borde inox
acier émaillé noir, bord inox



| | Ø cm | ↑ cm | Topf / pot ltr. | Deckel / lid ltr. |
|-------|------|------|-----------------|-------------------|
| 00623 | 13,5 | 9,0 | 0,75 | 0,60 |
| 00625 | 18,0 | 12,0 | 2,60 | 1,40 |
| 00626 | 20,0 | 13,0 | 3,30 | 1,60 |
| 00627 | 24,0 | 13,5 | 5,20 | 2,70 |

CAKE STANDS



Servier- und Tortenplatte „CASUAL“
 cake plate
 porta pasteles
 présentoir à gâteaux



| | Ø cm | ↑ cm |
|-------|---------|------|
| 83890 | 31 | 8 |
| 83891 | 31 | 16 |
| | cm | ↑ cm |
| 83892 | 31 x 31 | 8 |
| 83893 | 31 x 31 | 16 |



Servier- und Tortenplatte
 cake stand
 porta pasteles
 présentoir à gâteaux



Rand fixiert die Haube, mit Antirutschfüßchen
 carved edge fixes the cover, with non-slip feet
 ranura para fijar bien la campana, con pies antideslizantes
 bord rainuré pour maintenir ferme la cloche, avec pieds antidérapants



| | Ø cm | ↑ cm | Farbe / Colour | fits to cover |
|-------|------|------|----------------|---------------|
| 00468 | 31 | 3,5 | White | 06520 |
| 00469 | 31 | 3,5 | Black | 06520 |



Servier- und Tortenplatte
 cake stand
 porta pasteles
 présentoir à gâteaux



Eichenholz geölt, mit Safrinne
 oak wood oiled, with juice groove
 madera de roble aceitada, mit Safrinne
 bois de chêne huilé, mit Safrinne

| | Ø cm | ↑ cm |
|-------|------|------|
| 00818 | 32 | 2,0 |

passende Hauben / suitable for covers / campanas adecuadas / cloches appropriées

| | Ø cm | ↑ cm |
|-------|------|------|
| 06520 | 30 | 22 |
| 06510 | 30 | 11,5 |

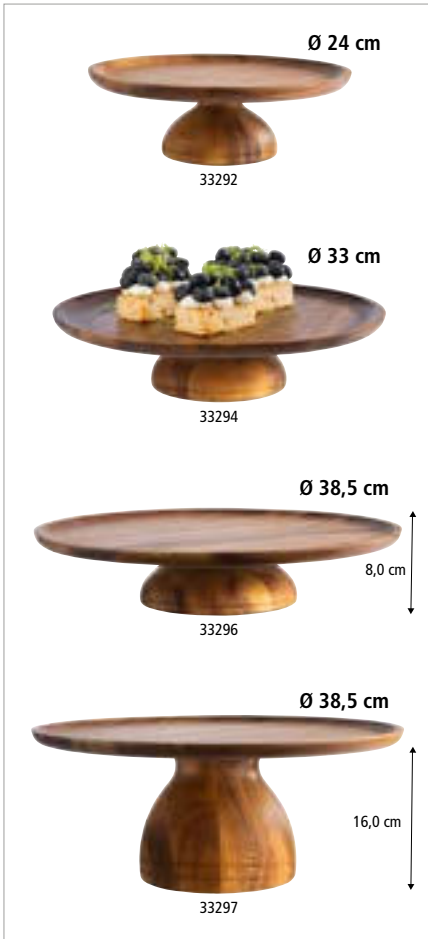

Servier- und Tortenplatte „ACACIA“

cake stand
porta pasteles
présentoir à gâteaux

Akazienholz geölt, möbelschonende Unterseite
acacia wood oiled, furniture-friendly underside
madera de acacia aceitada, con base anti rayaduras
bois d'acacia huilé, avec revêtement antirayures



| | Ø cm | ↑ cm |
|-------|------|------|
| 33292 | 24,0 | 8 |
| 33293 | 24,0 | 16 |
| 33294 | 33,0 | 8 |
| 33295 | 33,0 | 16 |
| 33296 | 38,5 | 8 |
| 33297 | 38,5 | 16 |



mit Rille
with groove

Frischhaltehaube / cover / campana / cloche



| | Ø cm | ↑ cm | fits to |
|-------|------|------|--------------|
| 06519 | 21 | 17 | 33292, 33293 |
| 06520 | 30 | 22 | 33294, 33295 |
| 06521 | 36 | 27 | 33296, 33297 |



drehbar
rotating

Servier- und Tortenplatte

cake stand
porta pasteles
présentoir à gâteaux

matt poliert, drehbar, möbelschonende Unterseite
matt polished, rotating, furniture-friendly underside
acabado pulido satinado, giratorio, base revestida de goma para no rallar el mobiliario
poli satiné, plateau tournant, avec revêtement antirayures



| | Ø cm | ↑ cm |
|-------|------|------|
| 00463 | 30,5 | 9 |



Servier- und Tortenplatte

cake stand
porta pasteles
présentoir à gâteau

matt poliert / matt polished / acabado efecto satinado / poli mat poli mat



| | Ø cm | ↑ cm |
|-------|------|------|
| 00046 | 31 | 3 |



Auslagen- / Kuchenplatte

display / cake plate
expositor / plato para tartas
présentoir / assiette à gâteau
ideale Größe für Baumkuchen / Stollen
ideal size for Baumkuchen / Stollen
tamaño ideal para Baumkuchen / Stollen
taille idéale pour Baumkuchen / Stollen



| | cm | ↑ cm |
|-------|---------|------|
| 00047 | 40 x 16 | 2,5 |

SUPER DOME



06525 Ø 30 cm

Frischhaltehaube „SUPER DOME“

cover
campana
cloche



schwere, glasklare Qualität
stable, crystal clear quality
muy resistente y transparencia cristalina
haute résistance et transparence

| | Ø cm | ↑ cm |
|-------|------|------|
| 06525 | 30 | 40 |

passende Servier-/Tortenplatten / suitable cake stands / porta pasteles compatibles / présentoirs à gâteaux compatibles

| | Ø cm | ↑ cm | fits to | Farbe / Colour |
|-------|------|------|---------|----------------|
| 00468 | 31,0 | 3,5 | 06525 | |
| 33294 | 33,0 | 8,0 | 06525 | |
| 33295 | 33,0 | 16,0 | 06525 | |

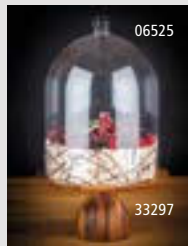

Präsentationsmöglichkeiten
presentation examples



Ø 21cm

tray
84942

Frischhaltehaube

cover
campana
cloche



schwere, glasklare Qualität
stable, crystal clear quality
calidad estable y transparencia cristalina
qualité stable et clarté cristalline

| | Ø cm | ↑ cm | fits to |
|-------|------|------|--|
| 06519 | 21 | 17 | 84941, 84942 |
| 06520 | 30 | 22 | 85034, 84177, 83891, 83890, 83884, 998, 975, 469, 468, 463, 462, 46 |
| 06521 | 36 | 27 | 84945, 84946 |

GRAVY BOATS



Sauciere „PROFI“

gravy boat
salsera
saucière

hochglanzpoliert, extra schwere Qualität
mirror polished, high quality
pulido brillante, alta calidad, base pesada
poli brillant, belle qualité, pied pesant



| | cm | ↑ cm | ltr. |
|-------|-----------|------|-------|
| 40208 | 13 x 6,0 | 9,0 | 0,075 |
| 40204 | 16 x 7,5 | 9,0 | 0,125 |
| 40205 | 19 x 9,0 | 13,0 | 0,25 |
| 40206 | 22 x 10,5 | 13,5 | 0,4 |



Sauciere „ECO“

gravy boat
salsera
saucière

hochglanzpoliert
mirror polished
pulido brillante
poli brillant



| | cm | ↑ cm | ltr. |
|-------|-------------|------|------|
| 40200 | 18,0 x 7,5 | 7,0 | 0,10 |
| 40203 | 21,5 x 9,5 | 8,5 | 0,15 |
| 40201 | 23,5 x 10,0 | 10,0 | 0,20 |
| 40202 | 23,5 x 12,0 | 12,0 | 0,45 |

PLATE TRAYS



Thermo-Sauciere

insulated sauce boat
salsera isotérmica
saucière thermique



doppelwandig, Klappdeckelverschluss, Einhandbedienung

double wall, hinged cover, one-hand operation

doble pared, tapa con bisagra, se maneja con 1 mano

double paroi, couvercle avec charnière, usage 1 main

| | cm | ↑ cm | ltr. |
|-------|-----------|------|------|
| 40207 | 19 x 12,5 | 13 | 0,4 |



Glocke

cloche / dome cover
campana esférica
cloche demi-sphère



außen hochglanzpoliert, innen matt poliert, mit verchromten Griff

outside mirror polished, inside matt polished, with chromeplated handle

exterior pulido brillante, interior pulido mate, pomo cromado

extérieur poli brillant, intérieur poli mat, buton chromé

| | Ø cm | ↑ cm |
|-------|------|------|
| 35734 | 29 | 18 |



Platzteller

plate tray
bajo plato
assiette de présentation



hochglanzpoliert, mit Fadendekor

mirror polished, with line edge

pulido brillante, con un filo en relieve

poli brillant, filet relief

| | Ø cm |
|-------|------|
| 35730 | 30,5 |
| 36233 | 33,0 |



Platzteller

plate tray
bajo plato
assiette de présentation



hochglanzpoliert, mit Perlrand

mirror polished, with pearl edge

acabado pulido brillante, con borde aperlado

poli brillant, bord perlé

| | Ø cm |
|-------|------|
| 35720 | 30,5 |
| 36323 | 33,0 |



Tischkrümelentferner

crumber
recogemigas
ramasse-miettes



matt poliert, geschliffene Edelstahlkante

matt polished, flat grinded stainless steel edge

pulido mate, borde plano de acero inoxidable rectificad

poli mat, bord plat rectifié en acier inox

| | cm | ↑ cm |
|-------|------------|------|
| 00581 | 19,0 x 4,5 | 1 |



Untersetzer, 6er Set

coaster, 6 pcs.
posavasos, set de 6
plateau sous-verre, set de 6

hochglanzpoliert, schwere Ausführung, Rand eingerollt
mirror polished, heavy quality, rolled edge
pulido brillante, alta calidad, borde redondeado
poli brillant, bord rond, qualité extra



| | Ø cm | pcs. |
|-------|------|------|
| 35711 | 10 | 6 |
| 35912 | 12 | 6 |



Untersetzer, 6er Set

coaster, 6 pcs.
posavasos, set de 6
plateau sous-verre, set de 6



| | Ø cm | pcs. |
|-------|------|------|
| 35716 | 11 | 6 |



Serviettenringe, 4er Set

napkin rings, 4 pcs.
servilleteros, set de 4
anneaux porte-serviette, set de 4



| | Ø cm | ↑ cm | pcs. |
|-------|------|------|------|
| 04446 | 4,5 | 2,5 | 4 |



Rechnungstablett

bill presenter
porta cuenta
porte-addition
mit Klemme für Rechnung
with clip for bill
con clip para la nota
avec clip pour la note



| | cm | ↑ cm |
|-------|---------|------|
| 30110 | 17 x 11 | 1,0 |



Rechnungstablett

bill presenter
porta cuenta
porte-addition
mit Klemme für Rechnung
with clip for bill
con clip para la nota
avec clip pour la note



| | cm | ↑ cm |
|-------|---------|------|
| 30108 | 20 x 12 | 0,5 |



Besteckkorb „ECONOMIC“
 cutlery dispenser
 dispensador de cubiertos
 corbeille à couverts



| | Ø cm | ↑ cm | Farbe / Colour |
|-------|------|------|----------------|
| 40130 | 12 | 15 | |
| 40007 | 12 | 15 | |
| 40012 | 12 | 15 | |
| 40013 | 12 | 15 | |



Besteckkorb „ECONOMIC“
 cutlery dispenser
 dispensador de cubiertos
 corbeille à couverts



| | cm | ↑ cm | Farbe / Colour |
|-------|---------|------|----------------|
| 40131 | 27 x 10 | 4,5 | |
| 40009 | 27 x 10 | 4,5 | |
| 40010 | 27 x 10 | 4,5 | |
| 40011 | 27 x 10 | 4,5 | |



Besteckständer
 cutlery basket
 porta cubiertos
 porte-couverts



Behälter aus Edelstahl, matt poliert
 container made of stainless steel, matt polished
 contenedor de acero inoxidable, pulido mate
 conteneur en acier inox, poli mat

| | Ø cm | ↑ cm |
|-------|------|------|
| 11921 | 10 | 10,0 |
| 11922 | 12 | 13,5 |



Besteckbehälter „ELEMENT“

cutlery bin
recipiente para cubiertos
récipients pour couverts

mit Abflussloch, mit Besteck Logo, Bodeneinlagen aus Silikon zum Schonen des Bestecks, möbelschonende Unterseite

with drain hole, with cutlery logo, silicone floor inserts for saving the points of knives, furniture-friendly underside

con orificio de drenaje, con logotipo de cubertería, soporte de silicona para proteger las puntas de los cuchillos, con base antirrayaduras

avec le trou de drainage, avec le logo de coutellerie, insert de silicone pour protéger les pointes des couteaux, avec base revêtue antirayures



| | Ø cm | ↑ cm |
|-------|------|------|
| 00018 | 11 | 14 |



Besteckköcher

cutlery basket
cesta para cubiertos
corbeille à couverts

Kunststoff weiß / white plastic / plástico blanco / plastique blanc



| | Ø cm | ↑ cm |
|-------|------|------|
| 11998 | 9,5 | 13,5 |

matt poliert / matt polished / pulido mate / poli mat

| | Ø cm | ↑ cm |
|-------|------|------|
| 11999 | 9,5 | 13,5 |



Tischreste-/ Besteckbehälter „TOP CHROME“

table waste bin / cutlery bin
papelera de sobremesa / recipiente para cubiertos
poubelle de table / récipients pour couverts

mit verchromten Rand / with chrome plated ring / con anillo cromado / avec bord chromé



| | Ø cm | ↑ cm | ltr. | Farbe / Colour |
|-------|------|------|------|----------------|
| 00025 | 13 | 15 | 1 | White |
| 00026 | 13 | 15 | 1 | Black |



Tischreste-/ Besteckbehälter „BASE CHROME“

table waste bin / cutlery bin
papelera de sobremesa / recipiente para cubiertos
poubelle de table / récipients pour couverts

mit verchromten Boden / with chrome bottom / con base cromada / avec base chromée



| | Ø cm | ↑ cm | ltr. | Farbe / Colour |
|-------|------|------|------|----------------|
| 00019 | 13 | 15 | 1,3 | White |
| 00020 | 13 | 15 | 1,3 | Black |



Tischreste-/ Besteckbehälter

table waste bin / cutlery bin
papelera de sobremesa / recipiente para cubiertos
poubelle de table / récipients pour couverts

mit verchromten Rand, inklusive herausnehmbarem Einteiler (4 Fächer)

with chrome plated ring, including devider (4 chambers)

con anillo cromado, incluyendo devider (4 cámaras)

avec bord chromé, y compris devider (4 chambres)



| | cm | ↑ cm | Farbe / Colour |
|-------|---------|------|----------------|
| 00016 | 14 x 14 | 16 | Black |



Table Caddy „COUNTRY STYLE“

table barrel
caddy de mesa
caddy de table



cooler Country-Style, nicht für den direkten Kontakt mit Lebensmittel verwendbar

condiment and cutlery holders or even for food presentation, the mini barrels should not come into contact with food, they should be lined with our greaseproof paper

estilo campestre, no aptos para el contacto directo con alimentos, sólo usando papel alimenticio

de style champêtre, pas de contact direct avec aliments, seulement en utilisant papier alimentaire

| | Ø cm | ↑ cm |
|-------|------|------|
| 11930 | 17,5 | 8,5 |
| 11931 | 11,5 | 14,0 |



Tischrestebehälter

table garbage bin
papelera de sobremesa
poubelle de table



| | Ø cm | ↑ cm | ltr. | Farbe / Colour |
|-------|------|------|------|----------------|
| 02038 | 11 | 14 | 0,9 | White |
| 02039 | 11 | 14 | 0,9 | Black |



Tischrestebehälter

table garbage bin
papelera de sobremesa
poubelle de table



| | Ø cm | ↑ cm | ltr. |
|-------|------|------|------|
| 00311 | 14 | 15 | 1,2 |



Tischrestebehälter

table garbage bin
papelera de sobremesa
poubelle de table



Kunststoff weiß / granit, abnehmbarer Schwingdeckel

white plastic, swing cover, cover removable

plástico blanco/granito, tapa basculante desmontable

plastique blanc/gris chiné, couvercle basculant démontable

| | Ø cm | ↑ cm | ltr. |
|-------|------|------|------|
| 00031 | 12 | 18 | 1,4 |



Tischrestebehälter

table garbage bin
papelera de sobremesa
poubelle de table



matt poliert, abnehmbarer Schwingdeckel, mit Bajonettverschluss

matt polished, swing cover, cover removable, with bayonet lock

pulido mate, tapa basculante desmontable, con cierre de bayoneta

poli mat, couvercle basculant démontable, avec fermeture à baïonnette

| | Ø cm | ↑ cm | ltr. |
|-------|------|------|------|
| 00029 | 12 | 17 | 1,2 |
| 00027 | 10 | 13 | 0,7 |

MENU HOLDERS



zum Einschieben der Speisekarten – schneller Austausch jederzeit möglich!
for inserting the menus - quick exchange possible at any time!



Der Kartenhalter ist völlig unkompliziert zu handhaben, denn er verfügt über eine Vorrichtung, in die die Karten einfach eingeschoben und schnell ausgetauscht werden können.

The menu holder is completely uncomplicated to handle, because it has a device into which the cards can simply be inserted and quickly exchanged.

El uso del porta menús es totalmente sencillo, ya que dispone de un dispositivo en el que simplemente se introducen las tarjetas y se intercambian rápidamente.

L'utilisation du porte-cartes est très simple, car il dispose d'un dispositif dans lequel les cartes peuvent être simplement insérées et rapidement échangées.



Kartenhalter 2-teilig
menu holder, 2 pcs.
porta menús, set de 2
porte-cartes, set de 2

Fuß aus Edelstahl, Menühalter aus Acryl
stainless steel base, menu holder made of acrylic
base de acero inoxidable, porta menús acrílico
base en acier inox, porte-cartes en acrylique



| | cm | ↑ cm | | |
|-------|----------|------|-----------------|--|
| 71521 | 10,5 x 7 | 17 | stainless steel | |
| 71527 | 10,5 x 7 | 17 | black | |



Kartenhalter 2-teilig
menu holder, 2 pcs.
porta menús, set de 2
porte-cartes, set de 2

Fuß aus Edelstahl, Menühalter aus Acryl
stainless steel base, menu holder made of acrylic
base de acero inoxidable, porta menús acrílico
base en acier inox, porte-cartes en acrylique



| | cm | ↑ cm | | |
|-------|--------|------|-----------------|--|
| 71522 | 15 x 7 | 23 | stainless steel | |
| 71528 | 15 x 7 | 23 | black | |



Kartenhalter 2-teilig
menu holder, 2 pcs.
porta menús, set de 2
porte-cartes, set de 2

Fuß aus Edelstahl, Menühalter aus Acryl
stainless steel base, menu holder made of acrylic
base de acero inoxidable, porta menús acrílico
base en acier inox, porte-cartes en acrylique



| | cm | ↑ cm | | |
|-------|--------|------|-----------------|--|
| 71523 | 21 x 7 | 32 | stainless steel | |
| 71529 | 21 x 7 | 32 | black | |

MENU HOLDERS

NEW



**2 tlg.
2 pcs.**

71520

Mini Staffelei, 2 teilig

easel mini, 2 pcs.
caballete mini, set de 2
chevale mini, set de 2



Ständer aus Akazienholz, Schild kann senkrecht oder waagrecht verwendet werden

acacia wood stand, sign can be used vertically or horizontally

soporte de madera de acacia, el cartel se puede utilizar vertical u horizontalmente

support en bois d'acacia, le panneau peut être utilisé verticalement ou horizontalement

| | cm | ↑ cm |
|------------------|-------------|------|
| 71520 | 13,5 x 10,0 | 19 |
| 71531 NEW | 19,5 x 15,0 | 24 |



waagrecht
horizontal



senkrecht
vertical



71490 **Kreide-Marker**
chalk marker

page 304

Inhalt ohne Stift
content without pen



**2 tlg.
2 pcs.**



71496



71497

Kartenhalter „ELEMENT“, 2 teilig

menu holder, 2 pcs.
soporte de tarjeta de menú, set de 2
porte-cartes de menu, set de 2



Fuß aus Beton, Menühalter aus Acryl

concrete base, acrylic menu sign / holder

base de hormigón, letrero de menú acrílico

socle en béton, plaque de menu en acrylique

| | cm | ↑ cm |
|-------|------------|------|
| 71496 | 11,5 x 4,5 | 10 |
| 71497 | 15,5 x 6,5 | 26 |

Kartenhalter-Set

card holder set
portatarjetas, set
porte-cartes, set



18-teilig: 6 Kartenhalter 4 x 2,5 cm + 12 Kunststoff-Beschriftungskarten 10 x 6 cm

18 pcs.: 6 card holder 4 x 2,5 cm + 12 plastic cards of inscription 10 x 6 cm

set de 18: 6 soportes 4 x 2,5 cm + 12 tarjetas de plástico 10 x 6 cm

set de 18: 6 supports 4 x 2,5 cm + 12 étiquettes en plastique 10 x 6 cm

| | cm |
|-------|---------|
| 00022 | 4 x 2,5 |



6 Stck. Halter
12 Stck. Karten



Kartenhalter, 4er Set

table stands, 4 pcs.
portatarjetas, set de 4
porte-cartes, set de 4

hochglanzpoliert, inklusive 20 schwarze Beschriftungskarten aus Polypropylen
mirror polished, including 20 black cards made of polypropylene
pulido brillante, incluye 20 tarjetas negras de polipropileno
poli miroir, inclut 20 étiquettes noires en polypropylène



| | Ø cm | ↑ cm | pcs. | Farbe / Colour | |
|-------|------|------|------|----------------|-----------------|
| 71510 | 5 | 10,5 | 4 | | stainless steel |
| 71513 | 5 | 15,5 | 4 | | stainless steel |
| 71516 | 5 | 20,5 | 4 | | stainless steel |



Kartenhalter, 4er Set

table stands, 4 pcs.
portatarjetas, set de 4
porte-cartes, set de 4

hochglanzpoliert, inklusive 20 schwarze Beschriftungskarten aus Polypropylen
mirror polished, including 20 black cards made of polypropylene
pulido brillante, incluye 20 tarjetas negras de polipropileno
poli miroir, inclut 20 étiquettes noires en polypropylène



| | Ø cm | ↑ cm | pcs. | Farbe / Colour | |
|-------|------|------|------|----------------|----------|
| 71512 | 5 | 10,5 | 4 | | gunmetal |



Beschriftungskarten, 10er Set

designation cards, 10 pcs.
tarjetas, set de 10
étiquettes, set de 10



| | cm | ✂ mm | pcs. |
|-------|---------|------|------|
| 00037 | 7,5 x 5 | 0,4 | 10 |



Bankettkartenständer

menu stand / table number
porta-etiqueta o carta de sobremesa
porte-étiquette de table, porte-menu, ou n° de table

hochglanzpoliert, schwere Qualität
mirror polished, heavy gauge
pulido brillante, alta calidad
poli brillant, belle qualité



| | Ø cm | ↑ cm |
|-------|------|------|
| 71460 | 7,5 | 18,5 |
| 71461 | 7,5 | 29 |



Tischkartenhalter, 4er Set

table stands, 4 pcs.
pinzas porta-etiquetas, set de 4
porte-étiquettes à pince, set de 4

hochglanzpoliert, schwerer Fuß, inklusive 20 weiße Beschriftungskarten
mirror polished, heavy foot, including 20 white labels
pulido brillante, incluye 20 etiquetas en blanco
poli brillant, inclut 20 étiquettes blanches



| | Ø cm | ↑ cm | pcs. |
|-------|------|------|------|
| 00070 | 4 | 10 | 4 |

MENU HOLDERS



Tischaufsteller, 10er Set

table stands, 10 pcs.
caballes de mesa, set de 10
chevalets de table, set de 10



Ecken abgerundet

corners rounded
esquinas redondeadas
coins arrondies

| | cm | ↑ cm | pcs. |
|-------|-----------|------|------|
| 00011 | 7,5 x 3,5 | 5 | 10 |
| 00012 | 10,5 x 6 | 6,5 | 10 |



Kartenhalter, 2er Set

card holder, 2 pcs.
soporte de mesa, set de 2
support de table, set de 2



inklusive 40 Beschriftungskarten, durch Magnete einfach zusammenklappbar

including 40 cards, easily foldable with magnets
incluye 40 tarjetas, fácil de plegar, con imanes
inclut 40 étiquettes, fácil à plier, avec aimants

| | cm | ↑ cm | pcs. |
|-------|-------|------|------|
| 00076 | 9 x 3 | 5,5 | 2 |



Kartenhalter, 2er Set

menu holder, 2 pcs.
porta cartas de mesa, set de 2
supports pour menu de table, set de 2



Rubberwood / rubber wood / madera de goma / bois d'hévéa

| | cm | ↑ cm | pcs. |
|-------|---------|-----------|------|
| 00023 | 8,5 x 6 | 4,5 / 8,5 | 2 |



Kartenhalter, 2er Set

menu holder, 2 pcs.
porta cartas de mesa, set de 2
porte-menus de table, set de 2



matt poliert

matt polished
pulido mate
poli mat

| | cm | ↑ cm | pcs. |
|-------|---------|---------|------|
| 00021 | 8,5 x 4 | 4 / 8,5 | 2 |



Tischkartenhalter
table stand
soporte-carta para la mesa
support pour menu de table



matt poliert
matt polished
pulido mate
poli mat

| | cm | ↑ cm | pcs. |
|-------|---------|------|------|
| 00030 | 8 x 7,0 | 2 | 1 |
| 00036 | 6 x 4,5 | 4 | 1 |



Kartenhalter-Set, 4er Set



table stands, 4 pcs.
portatarjetas, set de 4
porte-cartes, set de 4
inklusive 30 Beschriftungskarten (15 x weiß + 15 x schwarz)
including 30 labels (15 x white + 15 x black)
incluye 30 tarjetas (15 x blanco + 15 x negro)
includ 20 étiquettes (15 x blanc + 15 x noir)

| | cm | ↑ cm | pcs. |
|-------|-------|------|------|
| 71492 | 3 x 3 | 3 | 4 |
| 71493 | 3 x 3 | 3 | 4 |
| 71494 | 3 x 3 | 12 | 4 |



Kartenhalter, 4er Set
table stands, 4 pcs.
soportes de mesa, set de 4
upport de table, set de 4



inklusive 20 weiße Beschriftungskarten ca. 10 x 8 cm
including 20 white labels 10 x 8 cm
incluye 20 etiquetas blancas 10 x 8 cm
20 étiquettes blanches incluses 10 x 8 cm

| | cm | ↑ cm | pcs. | Farbe / Colour |
|-------|-------|------|------|----------------|
| 00074 | 3 x 3 | 12 | 4 | light blue |



Kartenhalter, 4er Set
table stands, 4 pcs.
soportes de mesa, set de 4
support de table, set de 4



Rubberwood, inklusive 20 weiße Beschriftungskarten ca. 10 x 8 cm
rubber wood, including 20 white labels 10 x 8 cm
madera de goma, incluye 20 etiquetas blancas 10 x 8 cm
bois d'hévéa, 20 étiquettes blanches incluses 10 x 8 cm

| | cm | ↑ cm | pcs. | Farbe / Colour |
|-------|-----------|------|------|----------------|
| 00700 | 2,5 x 2,5 | 12 | 4 | light brown |

MENU HOLDERS



Kartenhalter „WÜRFEL“, 4er Set

table stands, 4 pcs.
soporte de mesa, set de 4
porte-étiquettes, set de 4

inklusive 20 weiße Beschriftungskarten ca. 10 x 8 cm, mehrfach beschriftbar

including 20 white labels 10 x 8 cm, multiple inscribable
incluye 20 etiquetas blancas 10 x 8 cm, inscribible múltiple
20 étiquettes blanches incluses 10 x 8 cm, inscriptible multiple



| | cm | pcs. |
|-------|-----------|------|
| 00078 | 3 x 3 x 3 | 4 |



Kartenhalter „ZYLINDER“, 4er Set

table stands, 4 pcs.
soporte de mesa, set de 4
porte-étiquettes, set de 4

inkl. 20 weiße Beschriftungskarten ca. 10 x 8 cm, mehrfach beschriftbar

incl. 20 white labels 10 x 8 cm
incluye 20 etiquetas blancas 10 x 8 cm
20 étiquettes blanches incluses 10 x 8 cm



| | cm | pcs. |
|-------|-----------|------|
| 00079 | 3 x 3 x 3 | 4 |



Tafelhalter / Schild

slate sign
caballete de mesa, pizarra
plaque signalétique avec support



| | cm | ↑ cm | pcs. |
|-------|--------|------|------|
| 00060 | 12 x 4 | 7 | 1 |



Kartenhalter, 2er Set „KLAMMER“

table stand, 2 pcs.
soporte de mesa, set de 2
support de table, set de 2

Kiefernholz, inklusive 30 Beschriftungskarten ca. 10 x 8 cm (15 x weiß, 15 x schwarz)

pine wood, including 30 cards 10 x 8 cm (15 x white, 15 x black)
madera de pino, incluye 30 tarjetas 10 x 8 cm (15 x blanco, 15 x negro)
bois de pin, inclut 30 étiquettes 10 x 8 cm (15 x blanc, 15 x noir)



| | cm | ↑ cm | pcs. | Farbe / Colour |
|-------|---------|------|------|----------------|
| 71487 | 4 x 2,5 | 10 | 2 | |
| 71489 | 4 x 2,5 | 10 | 2 | |

Beschriftungskarten, 50 Stück / designation cards, 50 pcs. set
cartelitos de designación, 50 piezas / cartes de désignation, 50 pièces

| | cm | pcs. | Farbe / Colour | fits to |
|-------|--------|------|----------------|--------------|
| 71498 | 10 x 8 | 50 | | 71487, 71489 |
| 71499 | 10 x 8 | 50 | | 71487, 71489 |



Kartenhalter, 2er Set

table stands, 2 pcs.
portatarjetas, set de 2
porte-cartes, set de 2

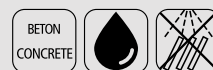

inklusive 30 Beschriftungskarten ca. 10 x 8 cm (15 x weiß + 15 x schwarz)

including 30 labels 10 x 8 cm (15 x white + 15 x black)

incluye 30 tarjetas 10 x 8 cm (15 x blanco + 15 x negro)

inclut 20 étiquettes 10 x 8 cm (15 x blanc + 15 x noir)

| | cm | ↑ cm | pcs. |
|-------|---------|------|------|
| 71495 | 8 x 3,5 | 6 | 2 |



Tischkartenhalter „PROFI“

table stand
soporte de mesa
support de table



| | cm | ↑ cm |
|-------|-----------|------|
| 40425 | 9,5 x 7,5 | 13,5 |



Tischkartenhalter

table stand
soporte de mesa
support de table



möbelschonende Unterseite

non-scratching undersurface

con base antirrayaduras

avec revêtement antirayures

| | cm | ↑ cm |
|-------|----------|------|
| 00071 | 14 x 5,5 | 14 |

MENU HOLDERS



71470

Schilderhalter „FLEXIBEL“

sign holder
soporte para cartelito
support pour menu de table



biegsamer Draht mit zwei Klemmen, extrem flexibel, die Klemmen lassen sich weit öffnen
bedable metal coil adds visual interest, two metal clip open
metal cromado flexible, 2 pinzas con gran apertura
métal chromé, flexible, 2 pinces à grande ouverture

| | → cm | |
|-------|------|--|
| 71470 | 12 | ohne Schilder / without signs sin cartelitos / sans étiquette |
| 71471 | 23 | ohne Schilder / without signs sin cartelitos / sans étiquette |
| 71480 | 12 | inkl. 10 Schilder 11879 / incl. 10 signs 11879 con 10 cartelitos 11879 / avec 10 étiquettes 11879 |

Schilder, 10er Set / signs, 10 pcs. / set de 10 cartelitos / set de 10 étiquettes

| | cm | |
|-------|-----------|--|
| 11879 | 7,7 x 5,2 | |
| 12879 | 5,0 x 3,0 | |



00572

00013

Tischaufsteller 2er Set

table stands, 2 pcs.
caballetes de mesa, set de 2
chevalets de table, set de 2



| | cm | ↑ cm | | pcs. |
|-------|---------|------|------------|------|
| 00017 | 5,5 x 5 | 3,5 | reserviert | 2 |
| 00013 | 5,5 x 5 | 3,5 | reserved | 2 |
| 00572 | 5,5 x 5 | 3,5 | no smoking | 2 |



Beschriftungsetiketten

labeling labels
etiquetas
étiquettes



12 Bögen mit je 6 Motiven, selbstklebend, mit wasserlöslichem Stift beschreibbar

12 sheets includes 6 self-adhesive and removable labels, use regular chalkboard markers and wipe clean with a damp cloth

12 hojas, cada una con 6 motivos autoadhesivos, se pueden marcar con un rotulador lavable con agua

12 feuilles chacune avec 6 motifs autoadhésifs, on peut écrire avec un stylo lavable à l'eau

| | cm | Farbe / Colour |
|-------|-----------|----------------|
| 00069 | 8,0 x 4,5 | ■ |



Kreide-Marker, Stärke 2 mm, 2er Set

chalk marker, 2 pcs.
rotulador de tiza, set de 2
marqueur a la craie liquide, set de 2



Zum Gestalten und Beschriften von Tafeln, Glas und fast allen geschlossenen Oberflächen, deckende Flüssigkreide auf Wasserbasis, feucht abwischbar

For decorating and writing on boards, glass and almost all non-porous surfaces, opaque water-based liquid chalk, wet-wipeable

Rotuladores para pizarra de tiza líquida para decorar y escribir sobre pizarras, cristales y casi todas las superficies no porosas. Tiza líquida opaca al agua que se pueda borrar con un trapo

Pour décorations et inscriptions sur tableaux, verre et presque toutes les surfaces non poreuses, craie liquide opaque à base d'eau, effaçable avec un chiffon humide

| | Ø cm | ↑ cm | Farbe / Colour | pcs. |
|-------|------|------|----------------|------|
| 71490 | 1 | 13 | ■ | 2 |
| 71491 | 1 | 13 | ■ | 2 |

NEW

Der nachhaltige Mehrwegbecher - made in Germany



eco-friendly



Das Ribbendesign isoliert die Hitze – kein „Verbrennen“ der Finger möglich

The rib design insulates the heat - no „burning“ of the fingers possible

Mehrwegbecher individuell mit Ihrem Logo/Namen herstellbar ab 500 Stck. – sprechen Sie uns an!

Reusable cups can be individually produced with your logo/name. From 500 pieces - please contact us!

- ✓ aufsteckbarer Deckel mit Trinköffnung
- ✓ 100% recyclebar
- ✓ spülmaschinengeeignet
- ✓ stapelbar mit und ohne Deckel
- ✓ schwappsicher

- clip-on lid with drinking opening
- 100% recyclable
- dishwasher safe
- stackable with and without lid
- slosh-/leak-proof

NEW



To Go Mehrwegbecher

To Go reusable cup
vaso reutilizable To Go
tasse réutilisable To Go

Becher (ohne Deckel)

cup (without cover)

vaso (sin tapa)

tasse (sans couvercle)



| | Ø cm | ↑ cm | ltr. | Farbe / Colour | VE / unit |
|-------|------|------|------|----------------|-----------|
| 66910 | 8,5 | 13,5 | 0,4 | | 48 |
| 66911 | 8,5 | 13,5 | 0,4 | | 48 |
| 66912 | 8,5 | 13,5 | 0,4 | | 48 |
| 66913 | 8,5 | 13,5 | 0,4 | | 48 |

Deckel / cover / tapa / couvercle

| | Ø cm | ↑ cm | Farbe / Colour | VE / unit |
|-------|------|------|----------------|-----------|
| 66914 | 8,5 | 2,5 | | 48 |
| 66915 | 8,5 | 2,5 | | 48 |
| 66916 | 8,5 | 2,5 | | 48 |
| 66917 | 8,5 | 2,5 | | 48 |





Körbe

baskets

cestas

corbeilles

| | |
|------------------------------|-----|
| PROFI LINE..... | 308 |
| GN LINE..... | 312 |
| ECONOMIC..... | 314 |
| BASKETS COVERS..... | 318 |
| BASIC..... | 319 |
| BREAD BASKETS..... | 320 |
| SNACKHOLDERS..... | 323 |
| URBAN..... | 324 |
| SVART..... | 325 |
| STAINLESS STEEL BASKETS..... | 326 |
| BASKETS RISERS..... | 328 |
| LUNCHBOXES..... | 329 |
| SUPERBOX..... | 330 |

PROFI LINE



hellbeige / light beige
beis claro / beige clair

beige / beige
beis / beige

braun / brown
marrón / marron

schwarz / black
negro / noir



Korb "PROFI LINE"
basket baker size
cesta tamaño panaderia
corbeille dimensions „boul-pâte“



| | cm | ↑ cm | Farbe / Colour |
|-------|---------|------|----------------|
| 50915 | 60 x 40 | 5 | hellbeige |
| 50918 | 60 x 40 | 5 | schwarz |



Korb "PROFI LINE"
basket baker size
cesta tamaño panaderia
corbeille dimensions „boul-pâte“



| | cm | ↑ cm | Farbe / Colour |
|-------|---------|------|----------------|
| 50910 | 60 x 20 | 5 | hellbeige |
| 50913 | 60 x 20 | 5 | schwarz |



Korb "PROFI LINE"
basket baker size
cesta tamaño panaderia
corbeille dimensions „boul-pâte“



| | cm | ↑ cm | Farbe / Colour |
|-------|---------|------|----------------|
| 50905 | 40 x 30 | 5 | hellbeige |
| 50908 | 40 x 30 | 5 | schwarz |

| | cm | ↑ cm | Farbe / Colour |
|-------|---------|------|----------------|
| 50710 | 40 x 30 | 10 | hellbeige |
| 50712 | 40 x 30 | 10 | schwarz |



Systemkorb, gestäbt „PROFI LINE“

basket
cesta
corbeille



| | cm | ↑ cm | Farbe / Colour |
|-------|---------|---------|----------------|
| 50305 | 45 x 40 | 27 / 16 | |



Systemkorb „PROFI LINE“

basket
cesta
corbeille



| | cm | ↑ cm | |
|-------|---------|---------|--|
| 50400 | 40 x 50 | 25 / 14 | |



GN 1/1 Korb „PROFI LINE“

GN 1/1 basket
GN 1/1 cesta
GN 1/1 corbeille

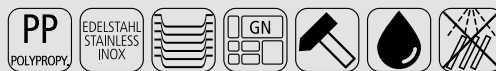

| | cm | ↑ cm | Farbe / Colour |
|-------|-----------|------|----------------|
| 50722 | 53 x 32,5 | 10 | |



Korb, rund „PROFI LINE“

basket, round
cesta redonda
corbeille ronde



| | Ø cm | ↑ cm | Farbe / Colour |
|-------|---------|--------|----------------|
| 50205 | 31 / 37 | 12 / 6 | |



Korb, rund „PROFI LINE“

basket, round
cesta redonda
corbeille ronde



| | Ø cm | ↑ cm | Farbe / Colour |
|-------|------|------|----------------|
| 50210 | 37 | 9 | |



Korb, rechteckig „PROFI LINE“

basket, rectangular
cesta, rectangular
corbeille, rectangulaire



| | cm | ↑ cm | Farbe / Colour |
|-------|-----------|------|----------------|
| 50702 | 26,5 x 19 | 7 | |

| | cm | ↑ cm | Farbe / Colour |
|-------|---------|------|----------------|
| 50707 | 31 x 21 | 9 | |

PROFI LINE



Baguette Korb, oval „PROFI LINE“

baguette basket, oval
cesta de baguette, oval
corbeille à baguettes, ovale



| | cm | ↑ cm | Farbe / Colour |
|-------|---------|------|----------------|
| 50805 | 28 x 16 | 8 | |
| 50806 | 28 x 16 | 8 | |
| 50808 | 28 x 16 | 8 | |
| 50807 | 28 x 16 | 8 | |

| | cm | ↑ cm | Farbe / Colour |
|-------|---------|------|----------------|
| 50823 | 40 x 16 | 8 | |



Korb, oval „PROFI LINE“

basket, oval
cesta oval
corbeille ovale



| | cm | ↑ cm | Farbe / Colour |
|-------|---------|------|----------------|
| 50800 | 25 x 19 | 6,5 | |
| 50801 | 25 x 19 | 6,5 | |
| 50803 | 25 x 19 | 6,5 | |
| 50802 | 25 x 19 | 6,5 | |

| | cm | ↑ cm | Farbe / Colour |
|-------|---------|------|----------------|
| 50815 | 32 x 23 | 7 | |
| 50817 | 32 x 23 | 7 | |



Korb, rund „PROFI LINE“

basket, round
cesta redonda
corbeille ronde



| | Ø cm | ↑ cm | Farbe / Colour |
|-------|------|------|----------------|
| 50600 | 16 | 8 | |
| 50601 | 16 | 8 | |
| 50603 | 16 | 8 | |
| 50602 | 16 | 8 | |

| | Ø cm | ↑ cm | Farbe / Colour |
|-------|------|------|----------------|
| 50605 | 20 | 8 | |
| 50606 | 20 | 8 | |
| 50608 | 20 | 8 | |
| 50607 | 20 | 8 | |

| | Ø cm | ↑ cm | Farbe / Colour |
|-------|------|------|----------------|
| 50612 | 29 | 7 | |



Korb, rechteckig „PROFI LINE“

basket, rectangular
cesta rectangular
corbeille rectangulaire



| | cm | ↑ cm | Farbe / Colour |
|-------|---------|------|----------------|
| 50631 | 19 x 13 | 6 | |
| 50630 | 19 x 13 | 6 | |



50624

Korb, oval „PROFI LINE“

basket, oval
cesta, oval
corbeille, ovale



| | cm | ↑ cm | Farbe / Colour |
|-------|---------|------|----------------|
| 50624 | 19 x 12 | 6 | |
| 50625 | 19 x 12 | 6 | |
| 50627 | 19 x 12 | 6 | |
| 50626 | 19 x 12 | 6 | |



50620

50621

50622

50623

Korb, rund „PROFI LINE“

basket, round
cesta, redonda
corbeille, ronde



| | Ø cm | ↑ cm | Farbe / Colour |
|-------|------|------|----------------|
| 50620 | 13 | 10 | |
| 50621 | 13 | 10 | |
| 50623 | 13 | 10 | |
| 50622 | 13 | 10 | |



Auslage Tablett flach „PROFI LINE“

display tray flat, baker size
bandeja de presentación, tamaño panadería
plateau de présentation, dimensions „boul-pâte“



| | cm | ↑ cm | Farbe / Colour |
|-------|---------|------|----------------|
| 40296 | 40 x 30 | 1 | |
| 40297 | 60 x 40 | 1 | |



Eierkorb „PROFI LINE“

egg basket
cesta de huevos
panier à oeufs



mit Edelstahldraht im Rand, für ca. 20 Eier, hält den Inhalt durch das Stofffutter lange warm
with stainless steel wire in the rim, for around 20 eggs, keeps the eggs warm thanks to the fabric lining
con alambre de acero inoxidable en el borde, para unos 20 huevos, mantiene los huevos calientes gracias al forro de tela
avec un fil d'acier inox dans la jante, pour env. 20 oeufs, garde les oeufs au chaud grâce à la doublure en tissu

| | Ø cm | ↑ cm | Farbe / Colour |
|-------|------|------|----------------|
| 40299 | 26 | 17 | |



Eierkorb

egg basket
cesta de huevos
panier à oeufs



stabile Vollweide, für ca. 20 Eier, hält den Inhalt durch das Stofffutter lange warm
stable willow, for around 20 eggs, keeps the eggs warm thanks to the fabric lining
saule de estable, para unos 20 huevos, mantiene los huevos calientes gracias al forro de tela
saule stable, pour env. 20 oeufs, garde les oeufs au chaud grâce à la doublure en tissu

| | Ø cm | ↑ cm | Farbe / Colour |
|-------|------|------|----------------|
| 30299 | 26 | 17 | |

GN LINE

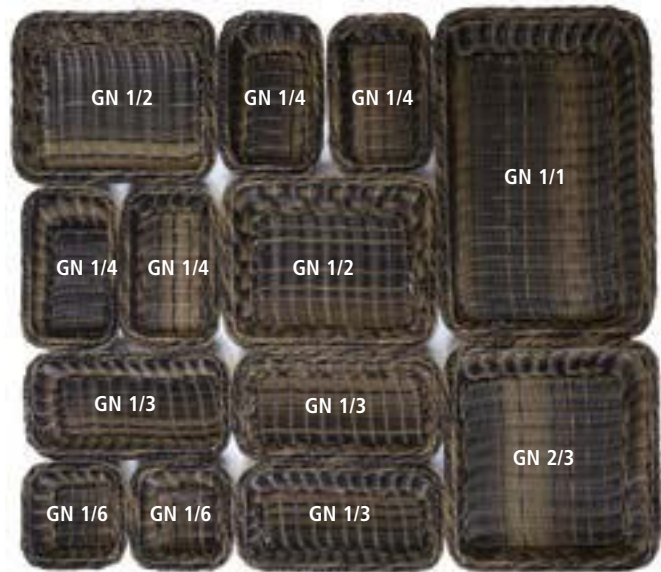

2 Höhen - 6,5 und 10 cm
2 heights - 6,5 and 10 cm



40293
GN 1/1 - 10 cm



40292
GN 1/2 - 10 cm

40225
GN 1/4 - 6,5 cm

Korb „GN LINE“

GN basket

GN cesta

GN corbeille



stabile Ausführung mit Edelstahldraht im Rand zur Stabilisierung

very solid with stainless steel wire frame to stabilize the basket

muy resistente con refuerzo de alambre inox

très résistante avec son fil de renfort inox

| | cm | ↑ cm | GN | Farbe / Colour |
|-------|-------------|------|-----|----------------|
| 40291 | 53,0 x 32,5 | 6,5 | 1/1 | ■ ■ |
| 40290 | 32,5 x 26,5 | 6,5 | 1/2 | ■ ■ |
| 40223 | 32,5 x 17,6 | 6,5 | 1/3 | ■ ■ |
| 40225 | 26,5 x 16,2 | 6,5 | 1/4 | ■ ■ |
| 40227 | 17,6 x 16,2 | 6,5 | 1/6 | ■ ■ |
| 40229 | 32,5 x 35,4 | 6,5 | 2/3 | ■ ■ |

| | cm | ↑ cm | GN | Farbe / Colour |
|-------|-------------|------|-----|----------------|
| 40293 | 53,0 x 32,5 | 10,0 | 1/1 | ■ ■ |
| 40292 | 32,5 x 26,5 | 10,0 | 1/2 | ■ ■ |
| 40243 | 32,5 x 17,6 | 10,0 | 1/3 | ■ ■ |
| 40245 | 26,5 x 16,2 | 10,0 | 1/4 | ■ ■ |
| 40247 | 17,6 x 16,2 | 10,0 | 1/6 | ■ ■ |
| 40249 | 32,5 x 35,4 | 10,0 | 2/3 | ■ ■ |



GN 1/1

GN 1/1 Besteckbehälter

GN 1/1 dispenser GN

GN 1/1 dispensador de cubiertos

GN 1/1 bac à couverts



4 Mulden, Kunststoff-Geflecht, Drahtgestell, braun-schwarz

4 compartments, with reinforced chromed wire structure, brown-black

4 compartimentos, de plástico, con bastidor cromado reforzado, marrón oscuro

4 compartiments, en plastique, cadre acier chromé renforcé, couleur marron foncé

| | cm | ↑ cm | GN | Farbe / Colour |
|-------|-----------|------|-----|----------------|
| 11966 | 53 x 32,5 | 9 | 1/1 | ■ ■ |

GN LINE

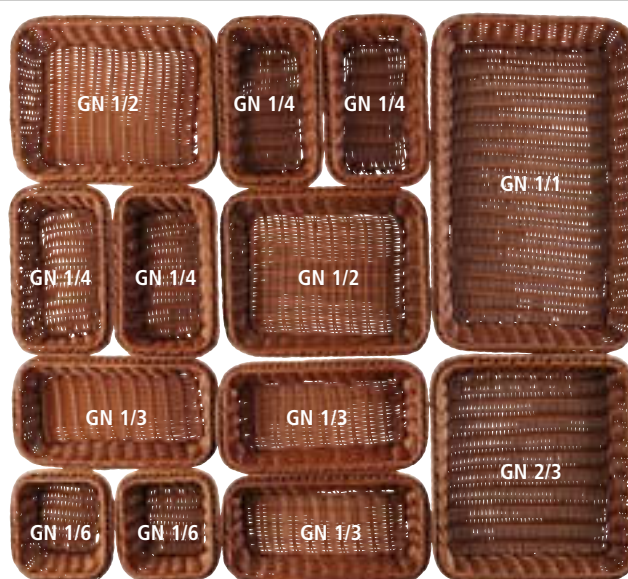

2 Höhen - 6,5 und 10 cm
2 heights - 6,5 and 10 cm



40220 GN 1/1



40222 GN 1/2



40228 GN 1/6



40264 GN 1/4

40272 GN 1/2

Korb „GN LINE“

GN basket
GN cesta
GN corbeille



stabile Ausführung mit Edelstahldraht im Rand zur Stabilisierung

very solid with stainless steel wire frame to stabilize the basket

muy resistente con refuerzo de alambre inox

très résistante avec son fil de renfort inox

| | cm | ↑ cm | GN | Farbe / Colour |
|-------|-------------|------|-----|----------------|
| 40220 | 53,0 x 32,5 | 6,5 | 1/1 | Yellow |
| 40222 | 32,5 x 26,5 | 6,5 | 1/2 | Yellow |
| 40224 | 32,5 x 17,6 | 6,5 | 1/3 | Yellow |
| 40226 | 26,5 x 16,2 | 6,5 | 1/4 | Yellow |
| 40228 | 17,6 x 16,2 | 6,5 | 1/6 | Yellow |
| 40230 | 32,5 x 35,4 | 6,5 | 2/3 | Yellow |
| | cm | ↑ cm | GN | Farbe / Colour |
| 40240 | 53,0 x 32,5 | 10 | 1/1 | Yellow |
| 40242 | 32,5 x 26,5 | 10 | 1/2 | Yellow |
| 40244 | 32,5 x 17,6 | 10 | 1/3 | Yellow |
| 40246 | 26,5 x 16,2 | 10 | 1/4 | Yellow |
| | cm | ↑ cm | GN | Farbe / Colour |
| 40260 | 53,0 x 32,5 | 6,5 | 1/1 | Brown |
| 40262 | 32,5 x 26,5 | 6,5 | 1/2 | Brown |
| 40263 | 32,5 x 17,6 | 6,5 | 1/3 | Brown |
| 40264 | 26,5 x 16,2 | 6,5 | 1/4 | Brown |
| | cm | ↑ cm | GN | Farbe / Colour |
| 40270 | 53,0 x 32,5 | 10 | 1/1 | Brown |
| 40272 | 32,5 x 26,5 | 10 | 1/2 | Brown |
| 40274 | 32,5 x 17,6 | 10 | 1/3 | Brown |
| 40276 | 26,5 x 16,2 | 10 | 1/4 | Brown |

ECONOMIC



Tisch- und Buffetkorb „ECONOMIC“
buffet basket
cesta de buffet
corbeille de buffet



| | Ø cm | ↑ cm | Farbe / Colour |
|-------|------|------|----------------|
| 40132 | 19,0 | 9,5 | Yellow |
| 40135 | 25,5 | 8,5 | Yellow |
| 40144 | 39,0 | 10,0 | Yellow |
| 40191 | 19,0 | 9,5 | Brown |
| 40192 | 25,5 | 8,5 | Brown |

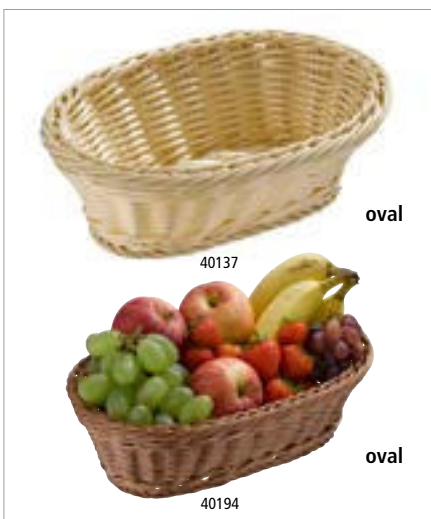

Tisch- und Buffetkorb „ECONOMIC“
buffet basket
cesta de buffet
corbeille de buffet



| | cm | ↑ cm | Farbe / Colour |
|-------|-----------|------|----------------|
| 40137 | 23,0 x 17 | 8,0 | Yellow |
| 40139 | 28,5 x 17 | 8,5 | Yellow |
| 40193 | 23,0 x 17 | 8,0 | Brown |
| 40194 | 28,5 x 17 | 8,5 | Brown |



stapelbar
stackable



Tisch- und Buffetkorb „ECONOMIC“
buffet basket
cesta de buffet
corbeille de buffet



| | cm | ↑ cm | Farbe / Colour |
|-------|-----------|------|----------------|
| 40140 | 23,0 x 17 | 8 | Yellow |
| 40159 | 31,5 x 22 | 8,5 | Yellow |
| 40195 | 23,0 x 17 | 8 | Brown |
| 40196 | 31,5 x 22 | 8,5 | Brown |



GN Buffetkorb „ECONOMIC“
GN basket
GN cesta
GN corbeille



| | cm | ↑ cm | GN | Farbe / Colour |
|-------|-----------|------|-----|----------------|
| 40148 | 53 x 32,5 | 8 | 1/1 | Yellow |



GN Buffetkorb „ECONOMIC“
GN basket
GN cesta
GN corbeille



| | cm | ↑ cm | GN | Farbe / Colour |
|-------|-------------|------|-----|----------------|
| 40152 | 32,5 x 26,5 | 8 | 1/2 | Yellow |

**Buffetkorb „ECONOMIC“**

buffet basket
cesta de buffet
corbeille de buffet



stabile Ausführung mit Edelstahldraht im Rand zur Stabilisierung

very solid with stainless steel wire frame to stabilize the basket

muy resistente con refuerzo de alambre inox

très résistante avec son fil de renfort inox

| | cm | ↑ cm |
|-------|---------|---------|
| 40153 | 45 x 42 | 17 / 24 |



40149

Buffetkorb, rund „ECONOMIC“

buffet basket, round
cesta de buffet, redonda
corbeille de buffet ronde



stabile Ausführung mit Edelstahldraht im Rand zur Stabilisierung

very solid with stainless steel wire frame to stabilize the basket

muy resistente con refuerzo de alambre inox

très résistante avec son fil de renfort inox

| | Ø cm | ↑ cm | Farbe / Colour |
|-------|------|------|----------------|
| 40149 | 40 | 12,5 | |
| 40295 | 40 | 12,5 | |



18389

Rolltophaube mit verchromtem Kugelgriff / rolltop cover with chrome plated handle / campana abatible con pomo cromado / cloche basculante avec bouton chromé

| | Ø cm | ↑ cm |
|-------|------|------|
| 18388 | 38 | 20 |

Rolltophaube mit vergoldetem Kugelgriff / rolltop cover with gold plated handle / campana abatible con pomo dorado / cloche basculante avec bouton doré

| | Ø cm | ↑ cm |
|-------|------|------|
| 18387 | 38 | 20 |

Rolltophaube mit verchromtem Designergriff / rolltop cover with chrome plated designer handle / campana abatible con pomo de diseño cromado / cloche basculante avec bouton design chromé

| | Ø cm | ↑ cm |
|-------|------|------|
| 18389 | 38 | 20 |



11010

Buffetkorb „ECONOMIC“

buffet basket
cesta de buffet
corbeille buffet



stabile Ausführung, Edelstahl Fixierungsrahmen, zur Rutschsicherung, ohne Haube

stainless steel fix the cover, without cover

con marco cromado patentado para fijar y encajar la campana (se entrega sin la campana)

cadre fil acier inoxydable pour fixer la cloche (livré sans la cloche)

| | cm | ↑ cm | Farbe / Colour |
|-------|-----------|------|----------------|
| 40150 | 56,5 x 36 | 10 | |
| 40294 | 56,5 x 36 | 10 | |



11018

GN 1/1 Rolltop-Haube / GN 1/1 rolltop cover / GN 1/1 campana abatible / GN 1/1 cloche basculante

| | cm | ↑ cm | GN | |
|-------|-----------|------|-----|--|
| 11008 | 53 x 32,5 | 19 | 1/1 | vergoldeter Griff / gold plated handle pomo dorado / bouton doré |
| 11010 | 53 x 32,5 | 19 | 1/1 | verchromter Griff / chrome plated handle pomo cromado / bouton chromé |
| 11018 | 53 x 32,5 | 17 | 1/1 | mit verchromtem Designergriff with chrome plated designer handle |

ECONOMIC



Buffetgestell „DOPPELDECKER“ für GN

buffet frame for GN
estructura para buffet para GN
support buffet pour GN



2-teilig, einfach zusammensetzbar, Etagen-Abstand 26 cm, platzsparend, stabile Ausführung

2 pcs., easy to assemble, distance between the tiers 26 cm, space-saving, robust

2 pzas, fácil de montar, distancia entre pisos 26 cm, robusto

2 pcs, assemblage facile, distance entre niveaux 26 cm, robuste

| | cm | ↑ cm | fits to GN |
|-------|---------|------|------------|
| 11555 | 50 x 34 | 37,5 | 1/1 |



GN Kuppelhaube

GN cover
GN cúpula
GN cloche bombée



glasklarer Kunststoff, Griff aus Zinkdruckguss

crystal clear plastic, die-cast zinc knob

plástico transparente, asa de zinc fundido a presión

plastique transparente, poignée en zinc moulé sous pression

| | cm | ↑ cm | GN | |
|-------|---------|------|-----|---|
| 11026 | 54 x 33 | 20 | 1/1 | geschlossen / totally closed cerrada / totalmente fermée |
| 11027 | 54 x 33 | 20 | 1/1 | mit Front-Ausschnitt / one long side cut out gran apertura frontal / grande ouverture frontale |
| 11028 | 54 x 33 | 20 | 1/1 | mit seitlichem Ausschnitt / one small side cut out / pequeña apertura lateral / petite ouverture latérale |



GN Kuppelhaube

GN cover
GN cúpula
GN cloche bombée



glasklarer Kunststoff, Griff aus Zinkdruckguss

crystal clear plastic, die-cast zinc knob

plástico transparente, asa de zinc fundido a presión

plastique transparente, poignée en zinc moulé sous pression

| | cm | ↑ cm | GN | |
|-------|---------|------|-----|---|
| 11070 | 54 x 33 | 20 | 1/1 | geschlossen / totally closed cerrada / totalmente fermée |
| 11071 | 54 x 33 | 20 | 1/1 | mit Front-Ausschnitt / one long side cut out gran apertura frontal / grande ouverture frontale |
| 11072 | 54 x 33 | 20 | 1/1 | mit seitlichem Ausschnitt / one small side cut out / pequeña apertura lateral / petite ouverture latérale |



Baguettekorb „ECONOMIC“

baguette basket
cesta para baguette
corbeille pour baguettes



stabile Ausführung mit Edelstahl draht im Rand zur Stabilisierung

very solid with stainless steel wire frame to stabilize the basket

muy resistente con refuerzo de alambre inox

très résistante avec son fil de renfort inox

| | Ø cm | ↑ cm | Farbe / Colour |
|-------|------|---------|----------------|
| 40198 | 35 | 24 / 42 | Yellow |



Besteckkorb „ECONOMIC“

cutlery dispenser
dispensador de cubiertos
corbeille à couverts



4 Fächer (3 kleine und 1 großes) / 4 compartments (3 small and 1 large) /
4 compartimentos (3 pequeños y 1 grande) / 4 compartiments (3 petits et 1 grand)

| | cm | ↑ cm | Farbe / Colour |
|-------|---------|------|----------------|
| 40179 | 26 x 18 | 15 | |
| 40182 | 26 x 18 | 15 | |



Besteckkorb „ECONOMIC“

cutlery dispenser
dispensador de cubiertos
corbeille à couverts



| | Ø cm | ↑ cm | Farbe / Colour |
|-------|------|------|----------------|
| 40130 | 12 | 15 | |
| 40007 | 12 | 15 | |
| 40012 | 12 | 15 | |
| 40013 | 12 | 15 | |



Besteckkorb „ECONOMIC“

cutlery dispenser
dispensador de cubiertos
corbeille à couverts



| | cm | ↑ cm | Farbe / Colour |
|-------|---------|------|----------------|
| 40131 | 27 x 10 | 4,5 | |
| 40009 | 27 x 10 | 4,5 | |
| 40010 | 27 x 10 | 4,5 | |
| 40011 | 27 x 10 | 4,5 | |



Brot- und Obstkorb „WICKER LOOK“

basket for bread or fruits
cesta para pan o fruta
corbeille à pain ou à fruits



| | cm | ↑ cm | Farbe / Colour |
|-------|---------|------|----------------|
| 40214 | Ø 20 | 6,5 | ■ |
| 40216 | 23 x 17 | 6,5 | ■ |

| | cm | ↑ cm | Farbe / Colour |
|-------|-------------|------|----------------|
| 40211 | 39,5 x 29,5 | 10 | ■ |
| 40212 | 39,5 x 29,5 | 10 | ■ |
| 40210 | 39,5 x 29,5 | 10 | ■ |



GN 1/1 Korb „SUPERSTRONG“

GN 1/1 basket
GN 1/1 cesta
GN 1/1 corbeille



| | cm | ↑ cm | GN | Farbe / Colour |
|-------|-----------|------|-----|----------------|
| 50644 | 53 x 32,5 | 10,0 | 1/1 | ■ |

GN Kuppelhaube / GN cover / GN cúpula / GN cloche bombée

| | cm | ↑ cm | GN |
|-------|---------|------|-----|
| 11027 | 54 x 33 | 20 | 1/1 |



passend zu Regalwagen 71441, S. 365
suitable for trolley 71441, S. 365



GN Kuppelhaube

GN cover
GN cúpula
GN cloche bombée



glasklarer Kunststoff, Griff aus Zinkdruckguss

crystal clear plastic, die-cast zinc knob

plástico transparente, asa de zinc fundido a presión

plastique transparente, poignée en zinc moulé sous pression

| | cm | ↑ cm | GN | |
|-------|---------|------|-----|--|
| 11070 | 54 x 33 | 20 | 1/1 | geschlossen / totally closed cerrada / totalmente fermée |
| 11071 | 54 x 33 | 20 | 1/1 | mit Front-Ausschnitt / one long side cut out gran apertura frontal / grande ouverture frontale |
| 11072 | 54 x 33 | 20 | 1/1 | mit seitlichem Ausschnitt / one small side cut out / pequeña apertura lateral / petite ouverture latérale |



GN Abdeckhaube

GN cover
GN cubierta
GN cloche



passend für GN 1/1 Körbe, glasklarer Kunststoff, nahezu bruchfest

suitable for GN 1/1 baskets, clear plastic, nearly unbreakable

apto para cestas GN 1/1, plástico transparente, muy resistente a la rotura

pour bacs et corbeilles GN 1/1, plastique transparent, très résistant à la casse

| | cm | ↑ cm | mm | GN |
|-------|-------------|------|----|-----|
| 11042 | 53,0 x 32,5 | 9,5 | 3 | 1/1 |

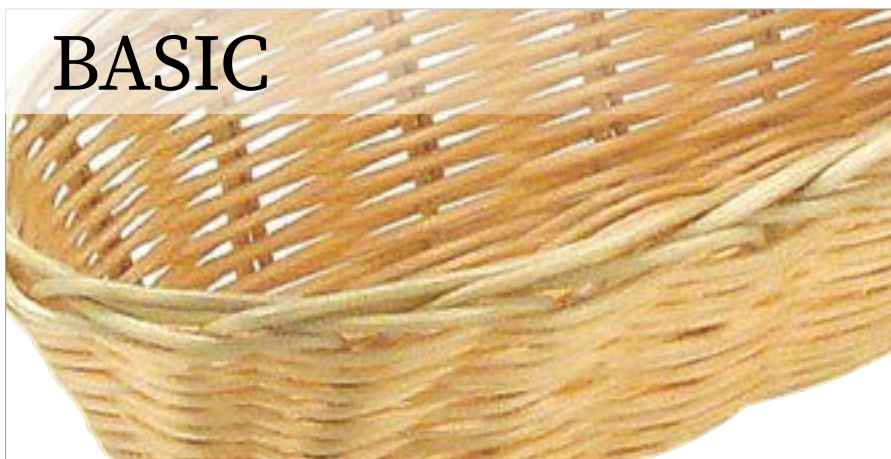

- in Handarbeit geflochten
- einfache und leichte Ausführung
- wickerwork
- simple and light version
- ligera
- tressada a mano
- tressé à main
- version légère



Brot- und Obstkorb „BASIC“
 basket for bread or fruits
 cesta para pan o fruta
 corbeille à pain ou à fruits



| | cm | ↑ cm |
|-------|---------|------|
| 30279 | 18 x 12 | 7 |
| 30280 | 23 x 15 | 6 |



Brot- und Obstkorb „BASIC“
 basket for bread or fruits
 cesta para pan o fruta
 corbeille à pain ou à fruits



| | cm | ↑ cm |
|-------|---------|------|
| 30282 | 21 x 10 | 6 |



Brot- und Obstkorb „BASIC“
 basket for bread or fruits
 cesta para pan o fruta
 corbeille à pain ou à fruits



| | Ø cm | ↑ cm |
|-------|------|------|
| 30281 | 20 | 7 |
| 30285 | 25 | 7 |



Tisch- und Buffetkorb „BASIC“
 buffet basket
 cesta de buffet
 corbeille de buffet



| | cm | ↑ cm |
|-------|---------|------|
| 30286 | 30 x 22 | 7 |
| 30283 | 22 x 15 | 6 |

BREAD BASKETS



Umgekrempelt kann die Höhe individuell gestaltet werden!
Adjustable height by turning the edge upside down!
Altura ajustable girando el borde al revés!
Hauteur ajustable en tournant le bord à l'envers!



Brottasche bread basket panera corbeille



eckig, 70% Naturfaser und 30% Kunstharz
angular, 70% natural fibre and 30% synthetic resin
ángulo, 70% fibra natural y 30% resina sintética
carré, 70% de fibres naturelles et 30% de résine synthétique

| | cm | ↑ cm | Farbe / Colour |
|-------|-----------|------|----------------|
| 30355 | 12 x 11,5 | 11,5 | ■ |
| 30356 | 12 x 11,5 | 11,5 | ■ |

rund, 70% Naturfaser und 30% Kunstharz
round, 70% natural fibre and 30% synthetic resin
redondo, 70% fibra natural y 30% resina sintética
ronde, 70% de fibres naturelles et 30% de résine synthétique

| | Ø cm | ↑ cm | Farbe / Colour |
|-------|------|------|----------------|
| 30440 | 17 | 11 | ■ |
| 30450 | 20 | 13 | ■ |
| 30442 | 24 | 24 | ■ |
| 30443 | 30 | 22 | ■ |
| 30441 | 17 | 11 | ■ |
| 30451 | 20 | 13 | ■ |
| 30445 | 24 | 24 | ■ |
| 30446 | 30 | 22 | ■ |

oval, 70% Naturfaser und 30% Kunstharz
oval, 70% natural fibre and 30% synthetic resin
oval, 70% fibra natural y 30% resina sintética
ovale, 70% de fibres naturelles et 30% de résine synthétique

| | cm | ↑ cm | Farbe / Colour |
|-------|---------|------|----------------|
| 30444 | 30 x 20 | 18 | ■ |
| 30447 | 30 x 20 | 18 | ■ |



Brottasche
bread basket
panera
corbeille



rund, schmutzabweisende Kunstfaser, 30°C waschbar, wendbar
round, dirt-repellent synthetic fibre, washable 30°C, reversible
redondo, fibra sintética repelente a la suciedad, lavable a 30°C, reversible
ronde, fibre synthétique anti-salissante, lavable à 30°C, réversible

| | Ø cm | ↑ cm | Farbe / Colour |
|-------|------|------|----------------|
| 30345 | 17 | 11,5 | ■ ■ |
| 30346 | 20 | 13,5 | ■ ■ |



Brottasche
bread basket
panera
corbeille



rechteckig, schmutzabweisende Kunstfaser, 30°C waschbar, wendbar
rectangular, dirt-repellent synthetic fibre, washable 30°C, reversible
rectangular, fibra sintética repelente a la suciedad, lavable a 30°C, reversible
rectangulaire, fibre synthétique anti-salissante, lavable à 30°C, réversible

| | cm | ↑ cm | Farbe / Colour |
|-------|---------|------|----------------|
| 30347 | 19 x 11 | 10,5 | ■ ■ |
| 30348 | 24 x 16 | 10,5 | ■ ■ |



Präsentationsmöglichkeit
presentation example



Brottasche
bread basket
panera
corbeille à pain en toile



Baumwolle, umgekrempelt kann die Höhe individuell gestaltet werden, maschinenwaschbar bis 30°C
cotton, adjustable height by turning the edge upside down, machine-washable 30°C
walgodón, altura ajustable girando el borde al revés, lavable a máquina 30°C
coton, hauteur ajustable en tournant le bord à l'envers, lavable en machine maxi 30°C

| | Ø cm | ↑ cm | Farbe / Colour |
|-------|------|------|----------------|
| 30340 | 17 | 11 | ■ ■ |
| 30350 | 20 | 12 | ■ ■ |
| 30341 | 17 | 11 | ■ ■ |
| 30351 | 20 | 12 | ■ ■ |

| | cm | ↑ cm | Farbe / Colour |
|-------|---------|------|----------------|
| 30360 | 20 x 15 | 10 | ■ ■ |
| 30370 | 25 x 18 | 12 | ■ ■ |
| 30361 | 20 x 15 | 10 | ■ ■ |
| 30371 | 25 x 18 | 12 | ■ ■ |

BREAD BASKETS



Brottasche mit Wärmekissen

bread basket with stones pillow
panera con cojín
corbeille à pain en toile avec coussin chauffant



Baumwolle, Keramik-Kugeln, maschinenwaschbar bis 30°C, mit Zugverschluss, Wärmekissen kann einfach in der Mikrowelle erhitzt werden (90 Sekunden / 500 Watt)

cotton, ceramic balls, machine washable up to 30°C, with drawstring closure, heat pad can easily be heated in the microwave (90 seconds / 500 watts)
algodón, bolas de cerámica, lavable a máquina hasta 30°C, con cierre de cordón, la almohadilla térmica se puede calentar fácilmente en el microondas (90 segundos / 500 vatios)
coton, billes en céramique, lavable en machine jusqu'à 30°C, avec fermeture à tirette, le coussin chauffant peut être facilement chauffé au micro-ondes (90 secondes / 500 watts)

| | Ø cm | ↑ cm | Farbe / Colour |
|-------|------|------|----------------|
| 30380 | 19 | 23 | Yellow |
| 30390 | 19 | 23 | Yellow / Brown |

Wärmekissen / stones pillow / cojín de piedrecillas a calentar / coussin de petites pierres, à chauffer

| | Ø cm | ↑ cm |
|-------|------|------|
| 30385 | 19 | 1,5 |



Häkelkorb

crochet rope basket
cesta de cuerda de ganchillo
panier en corde au crochet



umgekrepelt kann die Höhe individuell eingestellt werden

adjustable height by turning the edge upside down
altura ajustable girando el borde al revés
hauteur ajustable en tournant le bord à l'envers

| | cm | ↑ cm |
|-------|-----------|------|
| 30395 | 20 x 13,5 | 10 |
| 30396 | 24 x 17,5 | 12 |



Präsentationsmöglichkeit
presentation example



Lunchbag, 2er Set

lunch bag, 2 pcs.
bolsa de almuerzo, set de 2
sac à lunch, set de 2



70% Naturfaser und 30% Kunstharz, mit Klettverschluss

70% natural fibre and 30% synthetic resin, with velcro fastener
70% fibra natural y 30% resina sintética, con cierre de velcro
70% de fibres naturelles et 30% de résine synthétique, avec fermeture velcro

| | cm | ↑ cm | pcs. |
|-------|---------|------|------|
| 30357 | 16 x 10 | 32 | 2 |
| 30358 | 25 x 15 | 30 | 2 |



Präsentationsmöglichkeit
presentation example



40690 0,7 ltr.



40691 0,7 ltr.



40692 0,7 ltr.



40693 1,4 ltr.



40694 1,4 ltr.



40695 1,4 ltr.

Schale
bowl
cuenco
bol

gehämmerte Oberfläche
hammered surface
superficie martillada
surface martelée



| | Ø cm | ↑ cm | ltr. | Farbe / Colour | |
|-------|-------------|------|------|----------------|---------------|
| 40690 | 15,5 x 12,0 | 5,5 | 0,7 | | gold look |
| 40691 | 15,5 x 12,0 | 5,5 | 0,7 | | copper look |
| 40692 | 15,5 x 12,0 | 5,5 | 0,7 | | gunmetal-look |
| 40693 | 23,0 x 15,5 | 6,0 | 1,4 | | gold look |
| 40694 | 23,0 x 15,5 | 6,0 | 1,4 | | copper look |
| 40695 | 23,0 x 15,5 | 6,0 | 1,4 | | gunmetal-look |



Präsentationsmöglichkeit
presentation example



40604

Servierkorb „BURGER & FRIES“

serving basket
cesta para servir
corbeille de service



Servierkorb aus Metall mit 2 Haltern für Dipschälchen

metal serving basket with 2 holders for dip bowls

cesta de metal para servir con 2 soportes para cuencos para dip

corbeille de service en métal avec 2 supports pour ramequins

| | cm | ↑ cm |
|-------|-----------|------|
| 40604 | 39,5 x 20 | 11 |

passende Schälchen / suitable bowls / cuencos adecuados / bols apropiés



| | Ø cm | ↑ cm | ltr. | VE / unit |
|-------|------|------|------|-----------|
| 83781 | 7,5 | 4 | 0,07 | 24 |



83781

Servierbeispiel - Lieferung ohne Schälchen
delivery without bowls



Präsentationsmöglichkeit
presentation example

URBAN



GN Korb „URBAN“

GN basket
GN cesta
GN corbeille



| | cm | ↑ cm | GN | Farbe / Colour |
|-------|-------------|------|-----|----------------|
| 30414 | 53,0 x 32,5 | 7,5 | 1/1 | ■ |
| 30415 | 32,5 x 26,5 | 7,5 | 1/2 | ■ |
| 30416 | 53,0 x 16,2 | 7,5 | 2/4 | ■ |

GN Abdeckhaube

GN cover
GN cubierta
GN cloche



| | cm | ↑ cm | GN | |
|-------|-----------|------|-----|----------------|
| 11044 | 53 x 16,2 | 10,5 | 2/4 | ohne Abbildung |
| 11042 | 53 x 32,5 | 9,5 | 1/1 | ohne Abbildung |
| 11022 | 33 x 28,0 | 17,0 | 1/2 | ohne Abbildung |
| 11027 | 54 x 33,0 | 20,0 | 1/1 | |



Korb „URBAN“

basket
cesta
corbeille



| | cm | ↑ cm | Farbe / Colour |
|-------|---------|------|----------------|
| 30337 | 29 x 16 | 7 | ■ |



Korb „URBAN“

basket
cesta
corbeille



| | Ø cm | ↑ cm | Farbe / Colour |
|-------|------|------|----------------|
| 30410 | 17 | 7,0 | ■ |
| 30411 | 20 | 8,5 | ■ |



Korb „URBAN“

basket
cesta
corbeille



| | cm | ↑ cm | Farbe / Colour |
|-------|---------|------|----------------|
| 30412 | 21 x 10 | 7 | ■ |
| 30413 | 30 x 14 | 12 | ■ |

SVART

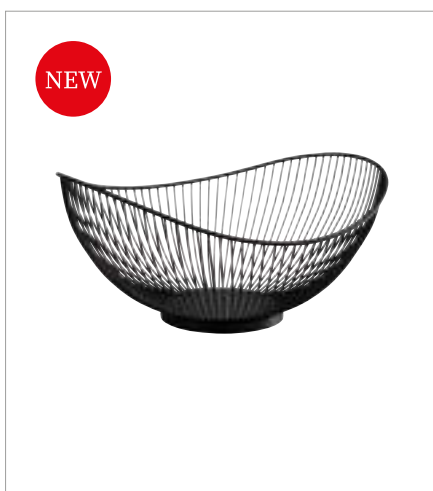

Korb „SVART“
basket
cesta
corbeille

Black
&
beautiful

METALL



| | cm | ↑ cm | Farbe / Colour |
|-------|-------------|------|----------------|
| 30424 | 29,5 x 25,5 | 13,5 | ■ |



Präsentationsmöglichkeit
presentation example



Korb „SVART“
basket
cesta
corbeille

Black
&
beautiful

METALL



| | cm | ↑ cm | Farbe / Colour |
|-------|---------|------|----------------|
| 30422 | 20 x 15 | 8 | ■ |
| 30423 | 24 x 19 | 8 | ■ |



Korb „SVART“
basket
cesta
corbeille

Black
&
beautiful

METALL



| | Ø cm | ↑ cm | Farbe / Colour |
|-------|------|------|----------------|
| 30420 | 17,5 | 8 | ■ |
| 30421 | 20,0 | 8 | ■ |

STAINLESS STEEL BASKETS

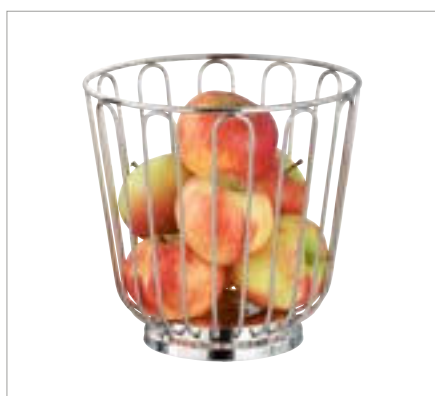

Obstkorb
 basket for fruits
 cesta para fruta
 corbeille à fruits
hochglanzpoliert
 mirror polished finish
 acabado pulido brillante
 brillant



| | ∅ cm | ↑ cm |
|-------|------|------|
| 30270 | 21,5 | 20,5 |



Brot- und Obstkorb
 basket for bread or fruits
 cesta para pan o fruta
 corbeille à pain ou à fruits
hochglanzpoliert, rund
 mirror polished finish, round
 acabado pulido brillante, redondo
 brillant, rond



| | ∅ cm | ↑ cm |
|-------|------|------|
| 30200 | 17,5 | 7,0 |
| 30220 | 20,5 | 8,5 |
| 30230 | 25,5 | 9,5 |

oval / oval / oval / oval

| | cm | ↑ cm |
|-------|---------|------|
| 30210 | 20 x 15 | 7,0 |
| 30240 | 24 x 19 | 8,5 |
| 30250 | 28 x 21 | 9,5 |

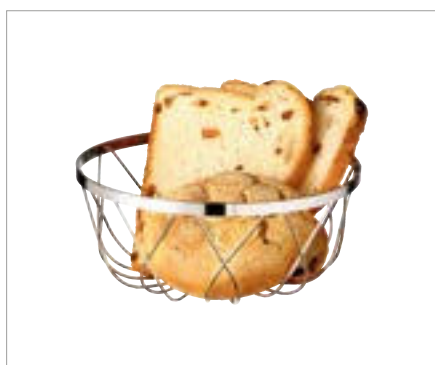

Brot- und Obstkorb
 basket for bread or fruits
 cesta para pan o fruta
 corbeille à pain ou fruits



| | ∅ cm | ↑ cm |
|-------|------|------|
| 30310 | 18 | 7,5 |

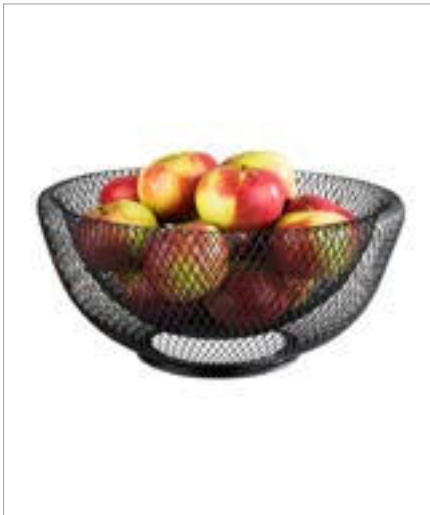

Brot- und Obstkorb „WIRE“
 wire basket
 cesta para pan o fruta
 corbeille pour pain ou fruits



| | Ø cm | ↑ cm | Farbe / Colour |
|-------|------|------|----------------|
| 30206 | 31 | 14 | metal black |



Präsentationsmöglichkeit
 presentation example

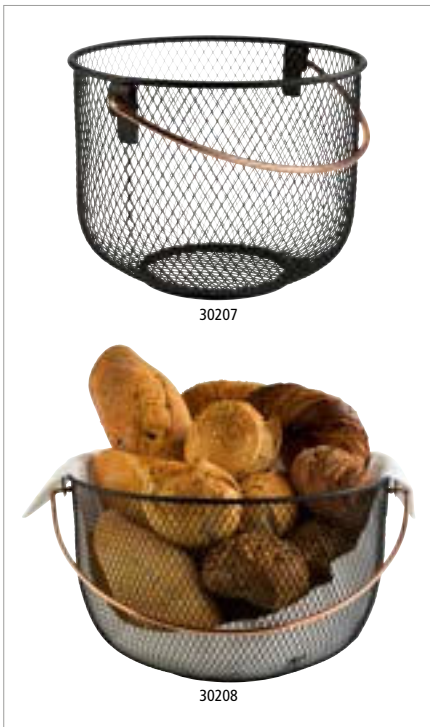

Brot- und Obstkorb
 basket for bread or fruits
 cesta para pan o fruta
 corbeille à pain ou fruits



| | Ø cm | ↑ cm | Farbe / Colour |
|-------|------|------|--------------------|
| 30207 | 21 | 16,5 | copper-look handle |
| 30208 | 30 | 19,0 | copper-look handle |



Präsentationsmöglichkeit
 presentation example



Schale
 bowl
 cuenco
 bol



gehämmerte Oberfläche / hammered surface / superficie martillada / surface martelée

| | cm | ↑ cm | ltr. |
|-------|-----------|------|------|
| 40189 | 20 x 13,5 | 5,5 | 0,30 |
| 40190 | 24 x 16,5 | 7,0 | 0,45 |

40190 **0,45 ltr.**



Brot- und Obstschale
 bowl for bread or fruits
 bol para pan o fruta
 bol à pain ou à fruits



hochglanzpoliert, Hammerschlag Optik
 mirror polished finish, hammered look
 acabado pulido efecto espejo, aspecto repujado
 brillant, aspect martelé

| | Ø cm | ↑ cm |
|-------|------|------|
| 30276 | 16 | 5,0 |
| 30277 | 20 | 5,5 |

30276



BASKETS / RISERS



Korb / Ständer „APS PLUS“

basket / riser
cesta / soporte
corbeille / support



| | Ø cm | ↑ cm | Farbe / Colour |
|-------|----------|------|-----------------|
| 15320 | 10,5 / 8 | 8 | polished chrome |
| 15324 | 10,5 / 8 | 8 | brushed gold |
| 15322 | 10,5 / 8 | 8 | brushed copper |



Korb / Ständer „APS PLUS“

basket / riser
cesta / soporte
corbeille / support



| | Ø cm | ↑ cm | Farbe / Colour |
|-------|------|------|-----------------|
| 15331 | 15 | 10,5 | polished chrome |
| 15332 | 21 | 20,0 | polished chrome |
| 15334 | 15 | 10,5 | brushed gold |
| 15335 | 21 | 20,0 | brushed gold |



Korb / Ständer „APS PLUS“

basket / riser
cesta / soporte
corbeille / support



| | Ø cm | ↑ cm | Farbe / Colour |
|-------|---------|------|----------------|
| 15326 | 21 / 15 | 21 | black |

LUNCHBOXES



Lunchbox „M“

lunchbox
fiambrella
boîte à lunch



Edelstahlbox mit Silikondichtung inkl. Trennsteg, auslaufsicher

stainless steel box with silicone seal incl. divider, leak-proof

caja de acero inoxidable con junta de silicona y divisor extraíble, transporte sin salpicaduras

boîte en acier inox avec joint en silicone et diviseur amovible, transport sans éclaboussures

| | cm | ↑ cm | ltr. |
|-------|-------------|------|------|
| 66900 | 18,5 x 13,5 | 6,5 | 0,8 |



Lunchbox „L“

lunchbox
fiambrella
boîte à lunch



Edelstahlbox mit Silikondichtung inkl. Trennsteg, auslaufsicher

stainless steel box with silicone seal incl. divider, leak-proof

caja de acero inoxidable con junta de silicona y divisor extraíble, transporte sin salpicaduras

boîte en acier inox avec joint en silicone et diviseur amovible, transport sans éclaboussures

| | cm | ↑ cm | ltr. |
|-------|-------------|------|------|
| 66901 | 20,5 x 14,5 | 6,5 | 1,1 |



Lunchbox „XL“

lunchbox
fiambrella
boîte à lunch



Edelstahlbox mit Silikondichtung inkl. Trennsteg, auslaufsicher

stainless steel box with silicone seal incl. divider, leak-proof

caja de acero inoxidable con junta de silicona y divisor extraíble, transporte sin salpicaduras

boîte en acier inox avec joint en silicone et diviseur amovible, transport sans éclaboussures

| | cm | ↑ cm | ltr. |
|-------|-------------|------|------|
| 66902 | 22,5 x 16,5 | 6,5 | 1,4 |



mit zwei Verschlüssen
with 2 clasps

66900

0,8 ltr.



66901

1,1 ltr.



66902

1,4 ltr.

herausnehmbarer Trennsteg
removable divider



auslaufsicher | leak-proof





SUPERBOX

11621
Box GN 1/2

00973
Schieferplatte
GN 2/4

11620
Box GN 1/1

Die stapelbaren Wendeböden lassen sich rutschfest stapeln und mit flachen GN Platten verbinden und einzeln nutzen. Individuell können Buffet-landschaften gebaut werden.

The stackable and non-slip reversible boxes can be connected to flat GN trays and can also be used individually. Different and individual buffet sceneries can be built up.

Las cajas girables y apilables son antideslizantes y se pueden conectar con bandejas planas GN o utilizar individualmente. Se pueden construir diferentes paisajes de buffet muy individuales.

Les boîtes de tournage empilables sont antiglissantes et peuvent être connectées avec des plateaux plats GN ou utilisées individuellement. Des paysages de buffet très personnalisés peuvent être construits.



GN 1/1 „SUPERBOX“



Akazienholz / acacia wood / madera de acacia / bois d'acacia

| | cm | ↑ cm | GN | Farbe / Colour |
|-------|-------------|------|-----|----------------|
| 11620 | 55,5 x 35,0 | 10,5 | 1/1 | ■ |
| 11626 | 55,5 x 35,0 | 10,5 | 1/1 | ■ |
| 11721 | 55,5 x 35,0 | 20,0 | 1/1 | ■ |
| 11723 | 55,5 x 35,0 | 20,0 | 1/1 | ■ |



GN 2/4 „SUPERBOX“



Akazienholz / acacia wood / madera de acacia / bois d'acacia

| | cm | ↑ cm | GN | Farbe / Colour |
|-------|-------------|------|----|----------------|
| 11623 | 55,5 x 18,5 | 10,5 | | ■ |
| 11629 | 55,5 x 18,5 | 10,5 | | ■ |



GN 1/2 „SUPERBOX“



Akazienholz / acacia wood / madera de acacia / bois d'acacia

| | cm | ↑ cm | GN | Farbe / Colour |
|-------|-------------|------|-----|----------------|
| 11621 | 35,0 x 29,0 | 10,5 | 1/2 | ■ |
| 11627 | 35,0 x 29,0 | 10,5 | 1/2 | ■ |
| 11722 | 35,0 x 29,0 | 20,0 | 1/2 | ■ |
| 11724 | 35,0 x 29,0 | 20,0 | 1/2 | ■ |



GN 1/4 „SUPERBOX“

Akazienholz / acacia wood / mader de acacia / bois d'acacia



| | cm | ↑ cm | Farbe / Colour |
|-------|-----------|------|----------------|
| 11622 | 29 x 18,5 | 10,5 | |
| 11628 | 29 x 18,5 | 10,5 | |



GN „SUPERBOX VINTAGE“

Akazienholz
acacia wood
mader de acacia
bois d'acacia

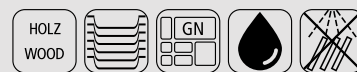

| | cm | ↑ cm | GN | Farbe / Colour |
|-------|-------------|------|-----|----------------|
| 11715 | 55,5 x 35,0 | 10,5 | 1/1 | |
| 11716 | 35,0 x 29,0 | 10,5 | 1/2 | |
| 11717 | 29,0 x 18,5 | 10,5 | 1/4 | |
| 11718 | 55,0 x 18,5 | 10,5 | 2/4 | |



Präsentationsmöglichkeiten
presentation examples



Buffetgestell

buffet stand
soporte para buffet
présentoir buffet



Metall, schwarz, passend für GN Boxen, mit Antrutschfüßchen
metal, black, suitable for GN boxes, with non-slip feet
metal, negro, apto para cajas GN, con pies antideslizantes
métal, noir, pour boîtes GN, avec pieds antidérapants

| | cm | ↑ cm | suitable for |
|-------|-----------|------|---------------------|
| 30331 | 49 x 38,5 | 48 | GN 1/1, GN1/2 boxes |



Präsentationsmöglichkeit
presentation example





Chafing Dish, GN Container & Transport

| | |
|--|-----|
| PREMIUM | 334 |
| GLOBE | 336 |
| EASY INDUCTION | 339 |
| INDUCTION STATION | 341 |
| CHAFING DISHES | 342 |
| FONDUE AND FIRE PUNCH BOWL SET | 347 |
| CHAFING DISHES ACCESSORIES | 348 |
| INDUCTION PLATES HEATING UNITS | 349 |
| HEATING UNITS WARMERS | 350 |
| GRANITE CHIPS CUTLERY RESTS | 351 |
| GN-CONTAINERS | 352 |
| SERVING TROLLEYS | 364 |
| CUTLERY BOXES | 366 |
| CONTAINERS EGG BOXES | 368 |
| BUCKETS FUNNELS | 369 |

PREMIUM



langlebige Deckelbremse
Abnehmbarer Deckel, dieser lässt sich spielend leicht öffnen und schließen, der Lauf des Deckels wird professionell gedämpft.



Kondenswasser - Rücklaufsystem
Kondenswasser wird in das Wasserbecken zurückgeführt.



Sandwichboden / Kapselboden
Induktionsfähiger Boden, direkt auf dem Induktionskochfeld einsetzbar. Perfekte Wärmeverteilung und Steuerung.



Fixierschraube / Rutschsicherung
Höhenverstellbares Gelenk, fixiert das Gerät in dem Gestell und auf dem Tisch.



Induktionskochplatte Nr. 12295
Induktionskochplatte wird einfach in das Gestell gelegt.



stapelbar
Chafing Dish Rahmen sind übereinander stapelbar. Platzsparend und rutschfest stapeln und transportieren.



Induktionskochplatte für Chafing Dish

induction plate for chafing dish
placa de inducción para chafing dish
plaque à induction pour chafing dish

mit Regler
with power control
con control de potencia
avec régulateur

| | Ø cm | |
|-------|------|-------|
| 12295 | 24 | 900 W |



12370

Lieferung ohne Induktionskochplatte
delivery without induction plate
se entrega sin placa de inducción
livré sans plaque à induction

GN 1/1 Chafing Dish „PREMIUM“



1 Gestell + 1 Wasserbecken mit Sandwichboden + 1 Wasserbeckenrahmen + 1 Deckel mit hydraulischem Gelenk + 1 GN 1/1 Behälter 65 mm tief, hitzebeständige Griffe, hochwertige Verarbeitung, ausschließlich für Induktionskochfelder

1 frame + 1 waterpan with sandwich base + 1 frame for waterpan + 1 hydraulic cover + 1 GN 1/1 container 65 mm, heat resistant handles, high quality, only for induction plates

1 soporte + 1 cubeta baño maría con base sandwich + 1 marco para cubeta baño maría + 1 tapa hidráulica + 1 cubeta GN 1/1 de 65 mm, asas resistentes al calor, acabado de alta calidad, solamente para inducción

1 pied support + 1 bac bain-marie avec fond sandwich + 1 cadre pour bac bain-marie + 1 couvercle hydraulique + 1 bac GN 1/1 de 65 mm, poignées résistantes à la chaleur, finition de qualité, uniquement pour induction

| | cm | ↑ cm | ltr. | |
|-------|---------|------|------|---|
| 12370 | 66 x 48 | 33 | 9 | mit Edelstahldeckel with stainless steel cover |
| 12352 | 66 x 48 | 33 | 9 | mit Glasdeckel with glass cover |



12353

Lieferung ohne Induktionskochplatte
delivery without induction plate
se entrega sin placa de inducción
livré sans plaque à induction

Chafing Dish rund „PREMIUM“



1 Gestell + 1 Wasserbecken mit Sandwichboden + 1 Wasserbeckenrahmen + 1 Deckel mit hydraulischem Gelenk + 1 runder Speisenbehälter, hitzebeständiger Griff, hochwertige Verarbeitung, für Induktionskochfelder geeignet

1 frame + 1 waterpan with sandwich base + 1 frame for waterpan + 1 hydraulic cover + 1 round foodpan, heat resistant handle, high quality, suitable for induction plates

1 soporte + 1 cubeta baño maría con base sandwich + 1 marco para cubeta baño maría + 1 tapa hidráulica + 1 cubeta redonda, asa resistente al calor, acabado de alta calidad, apto para inducción

1 pied support + 1 bac bain-marie avec fond sandwich + 1 cadre pour bac bain-marie + 1 couvercle hydraulique + 1 bac rond, poignée résistante à la chaleur, finition de qualité, apte pour induction

| | cm | ↑ cm | ltr. | |
|-------|---------|------|------|---|
| 12371 | 44 x 54 | 33 | 6 | mit Edelstahldeckel with stainless cover |
| 12353 | 44 x 54 | 33 | 6 | mit Glasdeckel with glass cover |

Speiseneinsatz / foodpan / cubeta / bac supérieur

12366



12372

Lieferung ohne Induktionskochplatte
delivery without induction plate
se entrega sin placa de inducción
livré sans plaque à induction

Chafing Dish rund „PREMIUM“



1 Gestell + 1 Wasserbecken mit Sandwichboden + 1 Wasserbeckenrahmen + 1 Deckel mit hydraulischem Gelenk + 1 runder Speisenbehälter, hitzebeständige Griffe, hochwertige Verarbeitung, für Induktionskochfelder geeignet

1 frame + 1 waterpan with sandwich base + 1 frame for waterpan + 1 hydraulic cover + 1 round foodpan, heat resistant handles, high quality, suitable for induction plates

1 soporte + 1 cubeta baño maría con base sandwich + 1 marco para cubeta baño maría + 1 tapa hidráulica + 1 cubeta redonda, asas resistentes al calor, acabado de alta calidad, apto para inducción

1 pied support + 1 bac bain-marie avec fond sandwich + 1 cadre pour bac bain-marie + 1 couvercle hydraulique + 1 bac rond, poignées résistantes à la chaleur, finition de qualité, apte pour induction

| | cm | ↑ cm | ltr. | |
|-------|---------|------|------|---|
| 12372 | 44 x 48 | 39 | 10 | mit Edelstahldeckel with stainless cover |
| 12354 | 44 x 48 | 39 | 10 | mit Glasdeckel with glass cover |

Speisenbehälter / foodpan / cubeta superior / bac supérieur

12397

GLOBE



die Deckelbremse sorgt für langsames Schließen

the revolving cover closes gently, thanks to a special built-in axle

sistema de freno para un cierre suave de la tapa

système avec frein pour une fermeture en douceur du couvercle



abnehmbarer Glas-Deckel mit Wasserrücklaufsystem

removable glass lid, with water-runback-system

tapa transparente desmontable con sistema de retorno de la condensación

couvercle transparent amovible avec système de retour de la condensation



Kondenswasser wird in das Wasserbecken zurückgeführt

condensed water is led back into the waterpan

el agua de condensación vuelve a la cubeta de agua

l'eau de condensation retourne dans le bac d'eau



für alle Herdarten geeignet, auch für Induktionskochplatten

suitable for all kinds of ovens, even induction cookers

apto para todas las fuentes de calor, incluso inducción

apte pour toutes les sources de chaleur, y compris induction



GN 1/1 Chafing Dish „GLOBE“



hochglanzpoliert, mit abnehmbarem hydraulischem Edelstahl-Deckel, Sandwichboden sorgt für optimale Wärmeleitung, für Induktionsplatten geeignet, Set: Gestell + Wasserbecken + Speisenbehälter GN 1/1 65 mm tief, 9 Liter + Löffelablage + 2 Brennpastenbehälter + Metallrahmen für Induktionskochplatte

mirror polished finish, removable stainless steel hydraulic cover, sandwich base for optimum heat distribution, suitable for induction plates

set: frame + waterpan + GN 1/1 container 65 mm, 9l + cutlery compartment ladles + 2 burner holder + frame for induction plate

pulido brillante, tapa hidráulica de acero inoxidable extraíble, fondo difusor sandwich apto para inducción, incluye: soporte + cubeta baño maría + cubeta GN 1/1 de 65 mm, 9 l + soporte para cuchara (sin cuchara) + 2 quemadores + marco para la placa de inducción

poli brillant, couvercle inox hydraulique amovible, fond diffuseur sandwich apte pour induction, comprend: pied support + bac bain-marie + bac GN 1/1 de 65 mm, 9 l + porte-louche (louche non incluse) + 2 brûleurs + cadre inox pour la plaque à induction

| | cm | ↑ cm | ltr. | |
|-------|-----------|------|------|---|
| 12394 | 66,5 x 44 | 34 | 9 | mit Edelstahldeckel with stainless cover |
| 12404 | 66,5 x 44 | 34 | 9 | mit Glasdeckel with glass cover |

Induktionskochplatte für Chafing Dish / induction plate for chafing dish / placa de inducción para chafing dish / plaque à induction pour chafing dish

12295

Metallrahmen für Induktionskochplatte / frame for induction plate / estructura o marco para placa de inducción / cadre support inox pour plaque induction

12296



Suppen-Kugel inkl. Gestell „GLOBE“

soup bowl with stand
cubeta sopa con soporte
récipient à soupe avec pied



hochglanzpoliert, inkl. Speisenbehälter, 1 Brennpastenbehälter, mit einhängbarer Löffelablage, Sandwichboden sorgt für optimale Wärmeverteilung, für Induktionsplatten geeignet, einfaches Anbringen und Entfernen des Deckels, hitzeisolierende Griffe, 1 Metallrahmen für Induktionskochplatten

mirror polished finish, incl. foodpan and 1 burner holder, with fitting compartment for ladles, sandwich bottom for optimum heat distribution, gentle opening of the lid, heat-resistant handles, frame for induction plate

acabado pulido brillante, cubeta sopa inox, 1 quemador, platillo a colgar para el cucharón, fondo difusor sandwich, apto para inducción, tapa con apertura controlada, asas frías, marco para placa de inducción

poli brillant, récipient à soupe inox, 1 brûleur, repose-couvert à accrocher, fond diffuseur sandwich, apte pour induction, couvercle à ouverture contrôlée, anses froides, cadre support inox pour plaque à induction

| | Ø cm | ↑ cm | ltr. |
|-------|------|------|------|
| 12398 | 48 | 45 | 10 |

Induktionskochplatte für Chafing Dish / induction plate for chafing dish / placa de inducción para chafing dish / plaque à induction pour chafing dish

12295

Metallrahmen für Induktionskochplatten / frame for induction plate / marco para placa de inducción / cadre support inox pour plaque induction

12291



Suppen-Kugel „GLOBE“

soup bowl
cubeta sopa
récipient à soupe



hochglanzpoliert, inkl. Speisenbehälter, mit einhängbarer Löffelablage, Sandwichboden sorgt für optimale Wärmeverteilung, für Induktionsplatten geeignet, einfaches Anbringen und Entfernen des Deckels, hitzeisolierende Griffe (Lieferung ohne Gestell, Löffel)

mirror polished finish, incl. foodpan, with fitting compartment for ladles, sandwich bottom for optimum heat distribution, gentle opening of the lid, heat-resistant handles (delivery without rack, ladle)

acabado pulido brillante, cubeta sopa inox, platillo a colgar para el cucharón, fondo difusor sandwich, apto para inducción, tapa con apertura controlada, asas frías (cucharón no incluido)

poli brillant, récipient à soupe inox, repose-couvert à accrocher, fond diffuseur sandwich, apte pour induction, couvercle à ouverture contrôlée, anses froides (cadre, louche non incluse)

| | Ø cm | ↑ cm | ltr. |
|-------|------|------|------|
| 12399 | 48 | 32 | 10 |

Gestell inkl. Brenner / frame incl. burner / soporte incluyendo quemador / support, brûleur inclus

12396

Speisenbehälter / foodpan / cubeta superior / bac supérieur

12397



Chafing Dish „GLOBE“



hochglanzpoliert, mit abnehmbarem hydraulischen Edelstahl-Deckel, Sandwichboden sorgt für optimale Wärmeleitung, für Induktionsplatten geeignet

Set: Gestell + Wasserbecken + Speisenbehälter rund + Löffelablage + Brennpastenbehälter + Metallrahmen für Induktionskochplatte

mirror polished finish, removable hydraulic cover, sandwich base, optimum heat distribution set: frame + waterpan + foodpan round + cutlery compartment ladles + burner holder + frame for induction plate

pulido brillante, con tapa hidráulica extraíble, fondo difusor sandwich apto para inducción. Incluye: 1 pie, 1 cubeta baño maria, 1 cubeta redonda, 1 soporte para cuchara (sin cuchara), 1 quemador, marco inox para la placa de inducción

brillant, couvercle hydraulique amovible, fond diffuseur sandwich apte pour induction.

Comprend: pied, cuve bain-marie, bac inox rond, porte-louche (louche non incluse), 1 brûleur, cadre inox pour la plaque à induction

| | Ø cm | ↑ cm | ltr. | |
|-------|------|------|------|---|
| 12393 | 38,5 | 34 | 6 | mit Edelstahldeckel with stainless cover |
| 12403 | 38,5 | 34 | 6 | mit Glasdeckel with glass cover |

Induktionskochplatte für Chafing Dish / induction plate for chafing dish / placa de inducción para chafing dish / plaque à induction pour chafing dish

12295

Metallrahmen für Induktionskochplatten / frame for induction plate / marco para placa de inducción / cadre support inox pour plaque induction

12291

Speiseneinsatz / foodpan / cubeta / bac supérieur

12366

Porzellan-Einsatz / porcelain insert / bandeja de porcelana / bac supérieur en porcelaine

| | Ø cm | ↑ cm | ltr. | fits to |
|-------|------|------|------|--------------|
| 82210 | 39 | 6 | 4,3 | 12393, 12403 |
| 82215 | 39 | 6 | 4,0 | 12393, 12403 |



GN 2/3 Chafing Dish „GLOBE“



hochglanzpoliert, mit abnehmbarem hydraulischem Edelstahl-Deckel, Sandwichboden sorgt für optimale Wärmeleitung, für Induktionsplatten geeignet, Set: Gestell + Wasserbecken + 1 GN 2/3 Behälter 65 mm tief + Löffelablage + 1 Brennpastenbehälter + 1 Metallrahmen für Induktionskochplatte

mirror polished finish, removable hydraulic cover, sandwich base, optimum heat distribution, set: frame + waterpan + foodpan GN 2/3, 65 mm, 5,5 l + compartment for ladles + burner holder + frame for induction plate

pulido brillante, con tapa hidráulica extraíble, fondo difusor sandwich apto para inducción. Incluye: 1 pie, 1 cubeta baño maria, 1 cubeta GN 2/3 65 mm - 5,5 l, 1 soporte para cuchara (sin cuchara), 1 quemador, marco inox para la placa de inducción

poli brillant, couvercle hydraulique amovible, fond diffuseur sandwich apte pour induction.

Comprend: pied, cuve bain-marie, bac inox GN 2/3-65 mm - 5,5 L, porte-louche (louche non incluse), brûleur, cadre inox pour la plaque à induction

| | cm | ↑ cm | ltr. | |
|-------|---------|------|------|--|
| 12483 | 44 x 41 | 34 | 5,5 | mit Edelstahl-Deckel with stainless steel cover |
| 12484 | 44 x 41 | 34 | 5,5 | mit Glasdeckel with glass cover |

EASY INDUCTION



die Deckelbremse sorgt für langsames Schließen

the revolving cover closes gently, thanks to a special built-in axle

sistema de freno para un cierre suave de la tapa

système avec frein pour une fermeture en douceur du couvercle



Druckhebel zum leichten Entnehmen des GN-Behälters

stick for easy removing of the GN-container

dispositivo para levantar y quitar con facilidad la cubeta GN

dispositif pour lever et retirer facilement le bac GN



abnehmbarer Glas-Deckel mit Wasserrücklaufsystem

removable glas lid, with water-runback-system

tapa transparente desmontable con sistema de retorno de la condensación

couvercle transparent amovible avec système de retour de la condensation



Fixierschraube verhindert das Rutschen

fixing screw for skid resistance

Pie trasero anti-deslizante, altura regulable

Pied supplémentaire anti-dérapant réglable en hauteur



GN 1/1 Chafing Dish „EASY INDUCTION“



1 Gestell + 1 Wasserbecken mit Sandwichboden + 1 Deckel mit hydraulischem Gelenk + 1 GN 1/1 Behälter 65 mm tief, hitzebeständige Griffe, hochwertige Verarbeitung, ausschließlich für Induktionskochfelder

1 frame + 1 waterpan with sandwich base + 1 hydraulic cover + 1 GN 1/1 container 65 mm, heat-resistant handles, high quality, only for induction plates

1 marco + 1 baño maría con base sandwich + 1 marco con tapa hidráulica + 1 cubeta GN 1/1 pan 65 mm profundo, asas resistentes al calor, buenos acabados, solamente para inducción

1 pied support + 1 bac bain-marie avec fond sandwich + 1 cadre avec couvercle hydraulique + 1 bac GN 1/1 - 65mm, poignées résistantes à la chaleur, belle qualité, uniquement pour induction

| | cm | ↑ cm | GN | ltr. |
|-------|---------|------|-----|------|
| 12322 | 60 x 42 | 30 | 1/1 | 9 |



GN 2/3 Chafing Dish „EASY INDUCTION“



1 Gestell + 1 Wasserbecken mit Sandwichboden + 1 Wasserbeckenrahmen + 1 Deckel mit hydraulischem Gelenk + 1 GN 2/3 Behälter 65 mm tief, hitzebeständige Griffe, hochwertige Verarbeitung, ausschließlich für Induktionskochfelder

1 frame + 1 waterpan with sandwich base + 1 frame for waterpan + 1 hydraulic cover + 1 GN 2/3 container 65 mm, heat-resistant handles, high quality, only for induction plates

1 marco + 1 baño maría con base sandwich + 1 marco con tapa hidráulica + 1 cubeta GN 2/3 pan 65 mm profundo, asas resistentes al calor, buenos acabados, solamente para inducción

1 pied support + 1 bac bain-marie avec fond sandwich + 1 cadre avec couvercle hydraulique + 1 bac GN 2/3 - 65mm, poignées résistantes à la chaleur, belle qualité, uniquement pour induction

| | cm | ↑ cm | GN | ltr. |
|-------|---------|------|-----|------|
| 12323 | 42 x 41 | 30 | 2/3 | 5,5 |





Lieferung ohne Induktionskochplatte
delivery without induction plate
se entrega sin placa de inducción
livré sans plaque à induction

Chafing Dish „EASY INDUCTION“



1 Gestell + 1 Wasserbecken mit Sandwichboden + 1 Deckel mit hydraulischem Gelenk + 1 runder Speisenbehälter, hitzebeständige Griffe, hochwertige Verarbeitung, ausschließlich für Induktionskochfelder geeignet

1 frame + 1 waterpan with sandwich base + 1 hydraulic cover + 1 round foodpan, heat-resistant handles, high quality, good for induction plates

1 soporte + 1 baño maría con base sandwich + 1 tapa hidráulica + 1 cubeta redonda, asas resistente al calor, buen acabado, apto para inducción

1 pied support + 1 bac bain-marie avec fond sandwich + 1 cadre avec couvercle hydraulique + 1 bac rond, poignées résistante à la chaleur, belle qualité, uniquement pour induction

| | cm | ↑ cm | ltr. |
|-------|---------|------|------|
| 12324 | 46 x 50 | 30 | 6 |



Lieferung ohne Induktionskochplatte
delivery without induction plate
se entrega sin placa de inducción
livré sans plaque à induction

Chafing Dish „EASY INDUCTION“



1 Gestell + 1 Wasserbecken mit Sandwichboden + 1 Deckel mit hydraulischem Gelenk + 1 runder Speisenbehälter, hitzebeständige Griffe, hochwertige Verarbeitung, ausschließlich für Induktionskochfelder geeignet

1 frame + 1 waterpan with sandwich base + 1 hydraulic cover + 1 round foodpan, heat-resistant handles, high quality, good for induction plates

1 soporte + 1 baño maría con base sandwich + 1 tapa hidráulica + 1 cubeta redonda, asas resistente al calor, buen acabado, apto para inducción

1 pied support + 1 bac bain-marie avec fond sandwich + 1 cadre avec couvercle hydraulique + 1 bac rond, poignées résistante à la chaleur, belle qualité, uniquement pour induction

| | cm | ↑ cm | ltr. |
|-------|---------|------|------|
| 12325 | 48 x 42 | 39 | 11 |



Induktionskochplatte für Chafing Dish

induction plate for chafing dish
placa de inducción para chafing dish
plaque à induction pour chafing dish

mit Regler

with power control
con control de potencia
avec régulateur

| | Ø cm | |
|-------|------|-------|
| 12295 | 24 | 900 W |



Porzellan-Einsatz

porcelain insert
bandeja de porcelana
bac supérieur en porcelaine



| | Ø cm | ↑ cm | ltr. | fits to |
|-------|------|------|------|---------------------|
| 82210 | 39 | 6 | 4,3 | 12324, 12393, 12403 |
| 82215 | 39 | 6 | 4,0 | 12324, 12393, 12403 |



inkl. Induktionskochplatte 900 Watt

Die Induktionsstation mit Regler präsentiert sich in einem Set aus Walnussholz, einem schwarzen Metallständer und einer Induktionsheizung.

The induction station with controller is presented in a set of walnut wood, a black metal stand and an induction heater.

La estación de inducción con regulador se presenta en un set formado por una caja de madera de nogal, un soporte de metal negro y un calentador de inducción.

La station à induction avec température réglable se compose d'un caisson en bois noyer, d'un support métallique noir et d'une plaque à induction.

Kochplatte Ø 24 cm
induction station Ø 24 cm



12270



12271



12272



12295

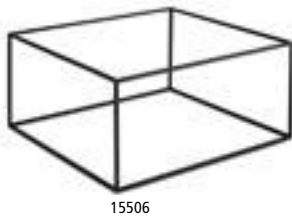

15506

Induktionsstation, 4-tlg. Set
induction station, 4 pcs.
estación de inducción, set de 4
station d'induction, set de 4

4 teiliges Set:

- 1 Induktionskochplatte mit Regler (Ø 24 cm, 900 Watt)
- 1 Metallständer schwarz
- 1 Rahmen aus Walnussholz geölt
- 1 Edelstahlrahmen

4 pcs. set:

- 1 induction hotplate with controller (Ø 24 cm, 900 Watt)
- 1 metal stand black
- 1 frame in oiled walnut wood
- 1 stainless steel frame

set de 4:

- 1 placa de inducción con regulador (Ø 24 cm, 900 vatios)
- 1 soporte de metal negro
- 1 caja de madera de nogal aceitada
- 1 marco de acero inoxidable

set de 4:

- 1 plaque d'induction avec température réglable (Ø 24 cm, 900 watts)
- 1 support métallique noir
- 1 caisson en bois noyer huilé
- 1 cadre en acier inox

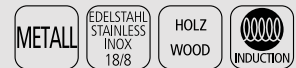

| | cm | ↑ cm |
|-------|-------------|------|
| 12270 | 35,4 x 32,5 | 19 |



4 ltr.

12330

passendes Chafing Dish Set 12330
sutable chafing dish set 12330

Ersatzteile / replacement parts / piezas de repuesto / pièces de rechange

| | cm | ↑ cm | |
|-------|-------------|------|---|
| 12271 | 35,4 x 32,5 | 8,5 | Holzrahmen / wooden frame |
| 12272 | 29,5 x 26,5 | 1 | Edelstahlrahmen / stainless steel frame |
| 12295 | Ø 24 | - | 900 Watt Induktionskochplatte / induction plate |
| 15506 | 35,4 x 32,5 | 17,6 | Buffetständer schwarz / buffet stand black |



Chafing Dish, 4-teiliges Set

chafing dish set, 4 pcs.
chafing dish, set de 4
chafing dish, set de 4



4-teiliges Set:

- 1 Topf (8 Liter)
- 1 Speisenbehälter (4 Liter)
- 1 Deckel mit Sichtfenster und 1 Deckelbremse,
- Topf mit induktionsfähigem Sandwich- / Kapselboden

4 pcs. set:

- 1 pot (8 litres),
- 1 foodpan (4 litres)
- 1 lid with glass insert and 1 automatic lid brake
- pot with induction-compatible sandwich base

set de 4:

- 1 olla (8 litros)
- 1 cubeta (4 litros)
- 1 tapa con ventanilla y 1 sistema de freno en la tapa
- olla con base sandwich apta para inducción

set de 4:

- 1 casserole (8 litres)
- 1 bac (4 litres)
- 1 couvercle avec fenêtre et 1 système de frein dans le couvercle
- casserole avec fond sandwich pour induction

| | Ø cm | ↑ cm | ltr. | Farbe / Colour | |
|-------|------|------|------|----------------|-----------|
| 12330 | 30,5 | 17,5 | 4 | | stainless |
| 12335 | 30,5 | 17,5 | 4 | | copper |
| 12336 | 30,5 | 17,5 | 4 | | yellow |
| 12337 | 30,5 | 17,5 | 4 | | red |
| 12338 | 30,5 | 17,5 | 4 | | black |



abnehmbarer Deckel
removable lid

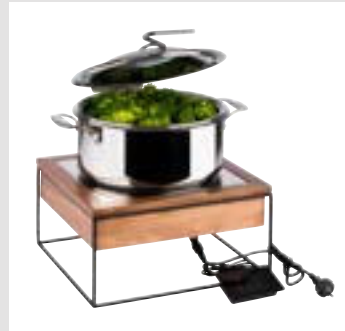

induktionsgeeignet
suitable for induction

Ersatz-Speisenbehälter zu Chafing Dish / replacement foodpan for chafing dish / cubeta interior de repuesto para chafing dish / bac intérieur de remplacement pour le chafing dish

| | Ø cm | ↑ cm | ltr. | fits to |
|-------|------|------|------|-----------------------------------|
| 12329 | 30,5 | 8 | 4 | 12330, 12335, 12336, 12337, 12338 |



8 ltr. Topf
8 ltr. pot



Sandwich- / Kapselboden
sandwich base



4 ltr. Speisenbehälter
4 ltr. foodpan



Deckelbremse
automatic lid break



12329



Rolltop-Chafing Dish „MAESTRO“



Speisenbehälter GN1/1 65 mm tief (passend auch für 100 mm) + Rolltopdeckel 90° + Wasserbecken inkl. Vorrichtung für Heizplatte + 2 Brennpastenbehälter
 foodpan GN1/1 65 mm (also for 100 mm) + rolltop cover 90° + waterpan with screws for heating unit + 2 burner holders
 cubeta GN 1/1 - 65 mm (hay espacio para una cubeta 100 mm) + campana rolltop abatible a 90° + 2 quemadores
 bac GN 1/1 - 65 mm (accepte aussi bac ht. 100 mm) + couvercle rolltop ouverture 90° + 2 brûleurs

| | cm | ↑ cm | ltr. |
|-------|---------|------|------|
| 12300 | 67 x 35 | 45 | 9 |



Rolltopdeckel 90°
rolltop cover 90°



Präsentationsmöglichkeit
presentation example



Rolltop-Chafing Dish „ELITE“



poliert, Rolltopdeckel klappbar auf 90° und 180°, Speisenbehälter GN 1/1 65 mm tief + Wasserbecken + 2 Brennpastenbehälter, wechseln des GN-Behälters ohne Abnehmen des Deckels (kein Kondenswasser-Rücklaufsystem)
 polished, rolltop cover adjustable at 90° and 180°, foodpan GN 1/1 65 mm deep + waterpan + 2 burner holders, change of the GN container without removing the lid (condensed water can not be led back into the waterpan)
 pulido brillante, tapa rolltop a 90° o 180°, cubeta GN 1/1 + 2 quemadores, cuba baño maría, se puede cambiar la cubeta GN sin retirar la tapa, importante: el agua condensada no revierte en los alimentos
 poli brillant, couvercle rolltop ouverture de 90 a 180°, bac GN 1/1, bain-marie, 2 brûleurs, le bac GN peut être retiré et remplacé sans démonter le couvercle, important: la condensation ne retombe pas sur les aliments

| | cm | ↑ cm | ltr. |
|-------|---------|------|------|
| 12350 | 67 x 47 | 45 | 9 |

Wasserbecken inkl. Vorrichtung für Heizelement / waterpan / baño maría / bain-marie

12249



inkl. Vorrichtung für Heizelement
incl. screws for heating unit

CHAFING DISHES



Rolltop-Chafing Dish „CATERER“



Speisenbehälter GN 1/1 65 mm tief + Rolltopdeckel 90° + Wasserbecken inkl. Vorrichtung für Heizplatte + 2 Brennpastenbehälter (Lieferung ohne Heizplatte), massiver Ständer
foodpan GN 1/1 65 mm deep + rolltop cover 90° + waterpan with screws for heatingunit + 2 burner holders (without heating unit), stable frame
1 cubeta GN 1/1 - 65 mm + campana rolltop abatible a 90° + 2 quemadores + cuba baño maría con fijaciones para resistencia amovible (se sirve sin la resistencia)
1 bac GN 1/1 - 65 mm + couvercle rolltop ouverture 90° + 2 brûleurs + 1 bac bain-marie avec 4 vis pour fixation résistance de chauffe amovible (non include)

| | cm | ↑ cm | ltr. |
|-------|---------|------|------|
| 12245 | 67 x 35 | 45 | 9 |

Wasserbecken inkl. Vorrichtung für Heizelement / waterpan / baño maría / bain-marie

12249



Chafing Dish „CATERER PRO“



Deckel hochglanzpoliert, Deckelgriffe hitzebeständig + 2 Brennpastenbehälter + Wasserbecken, inkl. Vorrichtung für Heizplatte + Gestell mit Deckelhalterung (ohne GN Speisenbehälter)
cover mirror polished finish, cover knob heat-resistant + 2 burner holders + waterpan with screws for heating unit + frame with coverholder (without GN foodpan)
tapa pulido brillante, asas frías + 2 quemadores + cuba inferior con tornillos para resistencia removible (no incluida) + tapa y estructura con sujeción de la tapa (se sirve sin la cubeta GN)
couvercle poli brillant, anses froides + 2 brûleurs + bac bain-marie avec fixations pour résistance amovible (non include)

| | cm | ↑ cm |
|-------|---------|------|
| 12233 | 64 x 35 | 34 |

Ersatzdeckel / replacement cover / tapa de recambio / couvercle de rechange

12236

Wasserbecken inkl. Vorrichtung für Heizelement / waterpan / baño maría / bain-marie

12249



Chafing Dish „CHEF“



Speisenbehälter GN 1/1 65 mm tief + 2 Brennpastenbehälter + Wasserbecken + Deckel + Gestell mit Deckelhalterung + langer Hohlgriff
foodpan GN 1/1 65 mm + 2 burner holders + waterpan + cove + frame with coverholder
1 cubeta GN 1/1 65 mm + 2 quemadores + cubeta para el agua + tapa y chasis con bloqueo para la tapa
1 bac GN 1/1 - 65 mm + 2 brûleurs + 1 bac bain-marie + couvercle + chasis avec blocage couvercle + poignée tube creux

| | cm | ↑ cm | ltr. |
|-------|---------|------|------|
| 11675 | 61 x 31 | 30 | 9 |



GN 1/1 100 mm
14 ltr.

Elektro-Rolltop-Chafing Dish „ELITE“

electric rolltop chafing dish
chafing dish eléctrico rolltop
chafing dish électrique rolltop



poliert, Rolltopdeckel klappbar auf 90° und 180°, Elektro-Wasserbecken mit Temperaturregung + Speisenbehälter GN 1/1 100 mm tief, 220 - 240 V ~ 50 Hz; 760 - 900 W (kein Kondenswasser-Rücklaufsystem)

polished, rolltop cover adjustable at 90° and 180°, electric waterpan with adjustable heatcontrol + foodpan GN 1/1 100 mm deep, voltage 220 - 240 V ~ 50 Hz, power consumption 760 - 900 W (condensed water cannot be led back into the waterpan)

pulido brillante, tapa abatible apertura a 90° o 180°, baño maría c/ termostato + cubeta GN 1/1 - 100 mm, 220-240 V-50 Hz. Consumo 760-900 W (el agua condensada no gotea dentro de la cubeta)

poli brillant, couvercle rolltop ouverture à 90° ou 180°, bain-marie électrique avec thermostat + bac GN 1/1-100 mm, 220-240 V - 50 Hz; 760-900 W (Important: la condensation ne retombe pas sur les aliments)

| | cm | ↑ cm | ltr. |
|-------|---------|------|------|
| 12360 | 67 x 47 | 45 | 14 |



Elektrischer Suppentopf „ECONOMIC“

electric soup warmer
marmita de sopa eléctrica
marmite à soupe électrique



Stahl schwarz lackiert, herausnehmbarer Einsatz aus Edelstahl, Temperaturregelung 30°C - 90°C, dreh- und klappbarer Edelstahl-Deckel, inkl. 8 magnetisch haftenden Beschriftungen, 400 W / 230 V

metal, black, removable soup pot, thermostat 30°C - 90°C, st. steel lid, incl. 8 magnetic signs, 400 W / 230 V

metal negro, recipiente sopa inox extraíble, termostato 30°C- 90°C, tapa inox, incluye 8 letreros magnéticos, 400 W / 230 V

acier, noir, récipient à soupe amovible, thermostat 30°C - 90°C, couvercle inox, 8 étiquettes magnétiques, 400 W / 230 V

| | Ø cm | ↑ cm | ltr. |
|-------|------|------|------|
| 11915 | 32 | 36 | 9 |

Speisenbehälter / foodpan / recipiente sopa / récipient à soupe

11916

Deckel / cover / tapa / couvercle

11917



Elektro Chafing Dish

electric chafing dish
chafing dish eléctrico
chafing dish électrique



Speisenbehälter GN 1/1 100 mm tief, Deckelhalter, Thermostat-Regelung 900 W, 230 V

foodpan GN 1/1 100 mm deep, lid holder, thermostat control 900 W, 230 V

cubeta GN 1/1-100 mm, sujeción de la tapa, termostato, 900W, 230 V

bac GN 1/1-100 mm, blocage du couvercle, thermostat, 900W, 230 V

| | cm | ↑ cm | ltr. |
|-------|---------|------|------|
| 12225 | 63 x 36 | 29 | 14 |

Deckel / cover / tapa / couvercle

12235

CHAFING DISHES



Elektro-Chafing Dish „ECO“

electric chafing dish
chafing dish eléctrico
chafing dish électrique



Deckel poliert, Elektro-Wasserbecken mit Temperaturregelung + Speisenbehälter GN 1/1
65 mm tief, 220 - 240 V ~ 50 Hz; 760 - 900 W

cover polished, electric waterpan with adjustable heatcontrol + foodpan GN 1/1 65 mm deep,
voltage 220 - 240 V ~ 50 Hz, power consumption 760 - 900 W

tapa pulido brillante, baño maría c/ termostato + cubeta GN 1/1 - 65 mm - 220-240 V-50 Hz. /
760-900 W

couvercle poli brillant, bain-marie électrique avec thermostat + bac GN 1/1-65 mm, 220-240
V - 50 Hz; 760-900 W

| | cm | ↑ cm | ltr. |
|-------|---------|------|------|
| 12232 | 63 x 36 | 29 | 9 |



Elektrischer Suppentopf

electric soup warmer
marmita de sopa eléctrica
marmite à soupe électrique



herausnehmbarer Einsatz aus Edelstahl, elektrisch, mit Wasserbad + Löffel + integrierter
Tragering für den Innenbehälter, Deckel mit hitzeisolierendem Griff, Temperaturregelung
80°C (± 10°C), 450-550 W, 230 V

removable soup st. steel pan, bain marie electric, ladle, circular frame,
thermostat control till 80°C (± 10°C), 450-550 W, 230 V

recipiente sopa inox extraíble, baño maría eléctrico + cucharón + aro inox, tapa con asas frías,
termostato hasta 80°C precisión (± 10°C), 450-550 W, 230 V

réipient à soupe inox amovible, bain-marie électrique, louche, support circulaire inox, ther-
mostat maxi 80°C (± 10°C), 450-550 W, 230 V

| | Ø cm | ↑ cm | ltr. |
|-------|------|------|------|
| 11901 | 38 | 36,5 | 10 |



Elektrischer Suppentopf

electric soup warmer
marmita de sopa eléctrica
marmite à soupe électrique



herausnehmbarer Einsatz aus Edelstahl, elektrisch, mit Wasserbad + Löffel + integrierter
Tragering für den Innenbehälter, Deckel mit hitzeisolierendem Griff, Temperaturregelung
80°C (± 10°C), 400 - 450 W / 220 - 240 V

removable soup st. steel pan, bain marie electric, ladle, st. steel circular frame,
thermostat control till 80°C (± 10°C), 400 - 450 W / 220 - 240 V

recipiente sopa inox extraíble, baño maría eléctrico + cucharón + aro inox,
tapa con asas frías, termostato hasta 80°C precisión (±10°C), 400 - 450 W / 220 - 240 V

réipient à soupe inox amovible, bain-marie électrique, louche, support circulaire inox, ther-
mostat maxi 80°C (± 10°C), 400 - 450 W / 220 - 240 V

| | Ø cm | ↑ cm | ltr. |
|-------|------|------|------|
| 11910 | 40 | 37 | 10 |

TWO IN ONE



Fondue

Feuerzange

13 tlg. Set
13 pcs. set

CHAFING DISH • GN CONTAINER • TRANSPORT



2,2 ltr.

65060

65061

6 Stk.
6 pcs.

65062

Fondue und Feuerzangenbowle-Set „TWO IN ONE“

fondue and fire punch bowl set
set para fondue o ponche caliente
service à fondue et à punch

13-teiliges Set aus Edelstahl bestehend aus:

1 Topf, 1 Rechaud, 1 Spritzschutz, 1 Untersetzer, 1 Schöpfkelle, 1 Feuerzange,
1 Pastenbrenner, 6 Fonduegabeln

13-piece stainless steel set consisting of:

1 pot, 1 rechaud, 1 splash guard, 1 coaster, 1 ladle, 1 fire tongs,
1 paste burner, 6 fondue forks

set de 13 piezas de acero inoxidable compuesto por:

1 olla, 1 rechaud, 1 protector contra salpicaduras, 1 trébede, 1 cazo,
1 pinza para el fuego, 1 quemador de pasta, 6 tenedores de fondue

set de 13 pièces en acier inox comprenant:

1 marmite, 1 rechaud, 1 pare-éclaboussures, 1 dessous de plat, 1 louche, 1 pince à feu,
1 brûleur à pâte, 6 fourchettes à fondue



| | Ø cm | ↑ cm | ltr. |
|-------|------|------|------|
| 65060 | 22 | 23 | 2,2 |

Brennpastenbehälter zu 65060

fuel paste container for 65060

recipiente para pasta de combustible para 65060

réipient pour pâte à combustible pour 65060



| | cm | ↑ cm | fits to |
|-------|---------|------|---------|
| 65061 | 26 x 12 | 10 | 65060 |

Gabelset zu 65060

fork set for 65060

set de tenedores para 65060

set de fourchettes pour 65060



| | cm | → cm | pcs. | fits to |
|-------|----|------------------|------|---------|
| 65062 | 24 | Griff / handle 8 | 6 | 65060 |



Kaffeedispenser „HAPPY HOUR“

coffee dispenser
dispensador de café
distributeur de café



hochglanzpoliert, für warme Getränke, stabil und standfest, inkl. 1 Brennpastenbehälter
mirror polished finish, for warm drinks, solid and stable, incl. 1 burner holder
acabado pulido brillante para bebidas calientes, sólido y estable, incluye un calentador
brillant, pour boissons chaudes, avec 1 brûleur, robuste et stable

| | cm | ↑ cm | ltr. |
|-------|-----------|------|------|
| 11672 | 31 x 33,5 | 54,5 | 10,5 |

Hahn / tap / grifo / robinet

11671

Elektro-Heizelement / heating unit / resistencia / résistance

| | cm | ↑ cm |
|-------|---------|------|
| 12287 | 21 x 20 | 6 |



Rolltophaube „SWISS“

rolltop-cover
campana rolltop
cloche rolltop



hochglanzpoliert, klappbar auf 90°, nachrüstbar für alle handelsüblichen Chafer
mirror polished finish, cover adjustable at 90°, usable for all commercial chafing dishes
pulido brillante, tapa ajustable 90°, apto para todos los chafings profesionales
poli brillant, ouverture réglable à 90°, apte pour tous les chafings professionnels

| | cm | ↑ cm |
|-------|---------|------|
| 12310 | 55 x 34 | 19,5 |



Bain-Marie Topf

bain marie pot
olla baño Maria
marmite bain-marie



inkl. Deckel, mit Löffelaussparung
included cover, notched for spoon
incluye tapa con hueco para la cuchara
includ le couvercle avec espace pour la louche

| | Ø cm | ↑ cm | ltr. |
|-------|------|------|------|
| 12244 | 20 | 18 | 4,5 |

Deckel / cover / tapa / couvercle

11244



Bain-Marie Deckel

cover for bain marie
tapa del baño maría
couvercle du bain-marie



| | cm |
|-------|-----------|
| 12243 | 54 x 33,5 |



Einbau-Induktionskochplatte für Chafing Dish

built-in induction plate for chafing dish
placa de inducción para empotrar
plaque à induction à encastrer

inkl. Kabel-Fernbedienung, energiesparend, Leistung in 5 Stufen regelbar

incl. cable remote control, energy-saving, power adjustable in 5 steps
incl. mando a distancia con cable, ahorro energético, potencia regulable en 5 pasos
y compris télécommande filaire, économe en énergie, puissance réglable en 5 étapes

| | | | |
|-------|-------------|------|--------|
| | cm | ↑ cm | |
| 12285 | 35,5 x 35,5 | 6 | 2000 W |



Induktionskochplatte für Chafing Dish

induction plate for chafing dish
placa de inducción para chafing dish
plaque à induction pour chafing dish

inkl. Kabel-Fernbedienung, energiesparend, Leistung in 5 Stufen regelbar

incl. cable remote control, energy-saving, power adjustable in 5 steps
incl. mando a distancia con cable, ahorro energético, potencia regulable en 5 pasos
y compris télécommande filaire, économe en énergie, puissance réglable en 5 étapes

| | | | |
|-------|------|--|-------|
| | Ø cm | | |
| 12295 | 24 | | 900 W |



Metallrahmen für Induktionskochplatten

frame for induction plate
marco para placa de inducción
cadre support inox pour plaque induction



| | |
|-------|---|
| 12291 | für runde Chafer / for round chafing dish |
| 12296 | für Chafer GN 1/1 / for GN 1/1 chafing dish |



Elektro-Heizelement

heating unit
resistencia
résistance



für Kaffeedispenser (Nr. 11672), 500 W, 220 V, einfach in das Gestell des Dispensers legen
for coffee dispenser (no. 11672), 500 W, 220 V, insert into the frame of the dispenser
para dispensador de café (11672), 500 W, 220V, directamente en el pie del dispensador
pour distributeur à café (11672), 500 W, 220 V, directement dans le support

| | |
|-------|---------------|
| 12287 | 500 W / 220 V |
|-------|---------------|



Heizplatte durch Spiralfeder an Wasserbad gedrückt
Heating plate is pressed against the water bath by a spiral spring

Mobile Chafing Dish Heizung

heating element
resistencia
résistance



für alle marktgängigen Chafing Dishes
suitable for all current popular chafing dishes, with special spring
para todos los chafing dish más corrientes
pour la plupart des chafing dish les plus courants

| | | | |
|-------|------|--------|---------------|
| | Ø cm | ↑ cm | |
| 12299 | 14 | 9 - 11 | 500 W / 220 V |



Elektro-Heizelement

heating unit
resistencia
résistance

for chafer covers are open most of the time



12290 360 W / 140 - 250 V



Elektro-Heizelement

heating unit
resistencia
résistance

for chafer covers are open most of the time



12292 600 W / 230 V



Elektro-Heizelement

heating unit
resistencia
résistance

for chafer covers are open most of the time



12294 800 W / 230 V



Brennpastenbehälter

burner holder
quemador
brûleur



mit Bajonettverschluss / bayonet lock / cierre de bayoneta / verrouillage par baïonnette

| | | |
|-------|------|------|
| | Ø cm | ↑ cm |
| 11683 | 9 | 6 |



Speisenwärmer

warmer
calienta platos
chauffe-plat



3-flammig / 3 lights / 3 velas / 3 bougies

| | | |
|-------|---------|------|
| | cm | ↑ cm |
| 35065 | 34 x 18 | 6 |



Speisenwärmer

warmer
calienta platos
chauffe-plat



2-flammig / 2 lights / 2 velas / 2 bougies

| | | |
|-------|---------|------|
| | cm | ↑ cm |
| 35343 | 34 x 13 | 6 |



Wärme-Kies

granite chips
granulado térmico
gravier thermique



für Chafing Dishes, feine Körnung, hohe Wärmespeicherung, kein Verkleben,
ideal zum Warmhalten von Eiern

fine for chafing dishes and clean granite chippings, ideal for keeping eggs warm
gravilla de granito fina limpia, ideal para mantener los huevos calientes
gravier fin de granit, lavé, idéal pour maintenir les oeufs au chaud



81116 7



82274

Präsentationsmöglichkeit
presentation example



Besteckablage

cutlery rest
reposa cuchara
pose-cuillère



cm ↑ cm

00650 27 x 11 3,5



Besteckablage „SMALL WAVE“

cutlery rest
reposa cuchara
pose-cuillère



cm ↑ cm

83897 26 x 13 4,5



Besteckablage „BOWL“

cutlery rest
reposa cuchara
pose-cuillère



cm ↑ cm ltr.

83803 22,5 x 11 6 0,5



Besteckablage „SPOON“

cutlery rest
reposa cuchara
pose-cuillère



cm ↑ cm

83801 26 x 10,5 5

GN-CONTAINERS

GN-Behälter Größen nach EN 631

Alle Behälter sind aus rostfreiem Chrom-Nickel-Edelstahl mit elektrolytisch polierter (seidenmatt) Oberfläche und somit perfekt geeignet für den professionellen Einsatz.

GN-container according to EN 631

All pans are made of chrome/nickel stainless steel with a surface polished by electrolysis (satin-matt) and therefore highly suitable for professional operation.

De conformidad con la norma europea EN 631.

Todos los contenedores están fabricados en acero inoxidable cromado/niquelado con su superficie (satinada) pulida por electrolisis lo que la hace altamente apropiado para el uso profesional.

Bacs GN- Conforme à la norme EN 631

Tous les bacs sont fabriqués en inox/chrome/nickel, surface polie électrolythique (satiné). Approprié pour usage professionnel.

Vorteile der rund geprägten U-Ecken:

- erhöhte Stabilität durch verstärktes Profil
- zielgerechtes und sauberes Ausgießen
- genaue Positionierung der GN-Behälter
- superleichtes Stapeln und Entstapeln
- kein Verklemmen der GN-Behälter
- hohe Stoßfestigkeit durch robuste Konstruktion
- ansprechendes Design und stilvoller Blickfang

Advantages of the round-shaped U-Corners:

- increased stability due to the unique construction
- clean ladling and pouring
- exact positioning of the containers
- improved shock-resistance
- appealing design
- no seize of the containers

Ventajas de las esquinas en U:

Perfil reforzado que confiere mayor rigidez y resistencia a la cubeta, diseño para verter fácil y limpiamente, fáciles de apilar y desapilar sin que se claven entre sí, construcción más robusta y resistente a los golpes mecánicos, diseño elegante.

Avantages et fonctionnalité des angles en U:

Profil renforcé pour une meilleure consistance et rigidité du récipient, design qui facilite un versage propre et aisé, permet un empilage et désempilage faciles sans que les bacs restent coincés, meilleure résistance aux chocs mécaniques, seign élégant.

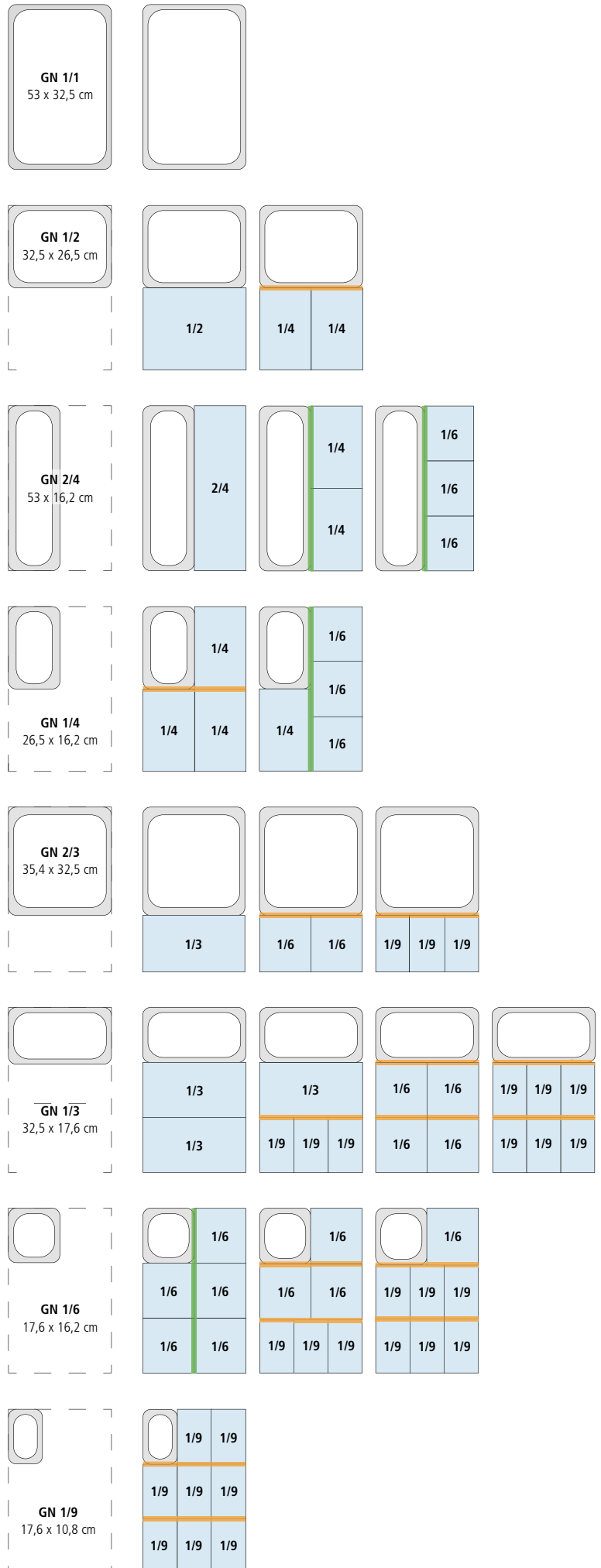

GN-Behälter

GN-container

GN cubetas

GN bacs



81102



81202



81302



81402



81604



81504



81702



81802

| | GN | ↓ mm | ltr. | cm |
|-------|-----|------|-------|-------------|
| 81000 | 2/1 | 20 | 5,0 | 53,0 x 65,0 |
| 81095 | 1/1 | 10 | 1,25 | 53,0 x 32,5 |
| 81100 | 1/1 | 20 | 2,5 | 53,0 x 32,5 |
| 81101 | 1/1 | 40 | 5,0 | 53,0 x 32,5 |
| 81109 | 1/1 | 55 | 6,5 | 53,0 x 32,5 |
| 81102 | 1/1 | 65 | 9,0 | 53,0 x 32,5 |
| 81104 | 1/1 | 100 | 13,25 | 53,0 x 32,5 |
| 81106 | 1/1 | 150 | 20,0 | 53,0 x 32,5 |
| 81108 | 1/1 | 200 | 25,0 | 53,0 x 32,5 |
| | GN | ↓ mm | ltr. | cm |
| 81200 | 1/2 | 20 | 1,0 | 32,5 x 26,5 |
| 81201 | 1/2 | 40 | 2,0 | 32,5 x 26,5 |
| 81209 | 1/2 | 55 | 2,8 | 32,5 x 26,5 |
| 81202 | 1/2 | 65 | 4,0 | 32,5 x 26,5 |
| 81204 | 1/2 | 100 | 6,0 | 32,5 x 26,5 |
| 81206 | 1/2 | 150 | 8,75 | 32,5 x 26,5 |
| 81208 | 1/2 | 200 | 11,65 | 32,5 x 26,5 |
| | GN | ↓ mm | ltr. | cm |
| 81300 | 1/3 | 20 | 0,75 | 32,5 x 17,6 |
| 81302 | 1/3 | 65 | 2,5 | 32,5 x 17,6 |
| 81304 | 1/3 | 100 | 4,0 | 32,5 x 17,6 |
| 81306 | 1/3 | 150 | 5,7 | 32,5 x 17,6 |
| 81308 | 1/3 | 200 | 7,0 | 32,5 x 17,6 |
| | GN | ↓ mm | ltr. | cm |
| 81400 | 1/4 | 20 | 0,5 | 26,5 x 16,2 |
| 81401 | 1/4 | 40 | 1,0 | 26,5 x 16,2 |
| 81402 | 1/4 | 65 | 1,8 | 26,5 x 16,2 |
| 81404 | 1/4 | 100 | 2,8 | 26,5 x 16,2 |
| 81406 | 1/4 | 150 | 4,0 | 26,5 x 16,2 |
| 81408 | 1/4 | 200 | 5,5 | 26,5 x 16,2 |
| | GN | ↓ mm | ltr. | cm |
| 81602 | 1/6 | 65 | 1,0 | 17,6 x 16,2 |
| 81604 | 1/6 | 100 | 1,6 | 17,6 x 16,2 |
| 81606 | 1/6 | 150 | 2,4 | 17,6 x 16,2 |
| 81608 | 1/6 | 200 | 3,0 | 17,6 x 16,2 |
| | GN | ↓ mm | ltr. | cm |
| 81502 | 1/9 | 65 | 0,6 | 17,6 x 10,8 |
| 81504 | 1/9 | 100 | 1,0 | 17,6 x 10,8 |
| 81506 | 1/9 | 150 | 1,5 | 17,6 x 10,8 |
| | GN | ↓ mm | ltr. | cm |
| 81700 | 2/3 | 20 | 1,5 | 35,4 x 32,5 |
| 81701 | 2/3 | 40 | 3,0 | 35,4 x 32,5 |
| 81702 | 2/3 | 65 | 5,5 | 35,4 x 32,5 |
| 81704 | 2/3 | 100 | 8,4 | 35,4 x 32,5 |
| 81706 | 2/3 | 150 | 12,5 | 35,4 x 32,5 |
| 81707 | 2/3 | 200 | 18,0 | 35,4 x 32,5 |
| | GN | ↓ mm | ltr. | cm |
| 81800 | 2/4 | 20 | 1,2 | 53,0 x 16,2 |
| 81801 | 2/4 | 40 | 2,4 | 53,0 x 16,2 |
| 81802 | 2/4 | 65 | 3,6 | 53,0 x 16,2 |
| 81804 | 2/4 | 100 | 5,6 | 53,0 x 16,2 |
| 81806 | 2/4 | 150 | 8,7 | 53,0 x 16,2 |

GN-CONTAINERS



81903

81901

81905

perforierte GN-Behälter

perforated GN-container
cubetas GN perforadas
bacs GN perforés



| | GN | ↓ mm | cm |
|-------|-----|------|-------------|
| 81911 | 1/1 | 40 | 53,0 x 32,5 |
| 81907 | 1/1 | 65 | 53,0 x 32,5 |
| 81908 | 1/1 | 100 | 53,0 x 32,5 |
| 81909 | 1/1 | 150 | 53,0 x 32,5 |
| 81910 | 1/1 | 200 | 53,0 x 32,5 |
| 81901 | 1/2 | 65 | 32,5 x 26,5 |
| 81902 | 1/2 | 100 | 32,5 x 26,5 |
| 81903 | 1/2 | 150 | 32,5 x 26,5 |
| 81904 | 1/2 | 200 | 32,5 x 26,5 |
| 81905 | 2/3 | 65 | 35,4 x 32,5 |
| 81906 | 2/3 | 100 | 35,4 x 32,5 |



2 x GN 1/4
26,5 x 16,2 cm

1 x GN 1/2
32,5 x 26,5 cm

4 ltr.

1,8 ltr.

1 x Adapter
31,5 cm

Lieferung in Farbverpackung
delivery in colour packaging

GN-Behälter Set, 4 teilig

GN-container, 4 pcs.
GN cubetas, set de 4
GN bacs, set de 4



bestehend aus: Edelstahlbehälter 1x GN 1/2 + 2x GN 1/4 + 1 Adapter

consisting of: stainless steel containers 1x GN 1/2 + 2x GN 1/4 + adapter

consiste en: cubetas de acero inoxidable 1x GN 1/2 + 2x GN 1/4 + adaptador

composé de: bacs en acier inox 1x GN 1/2 + 2x GN 1/4 + adaptateur

| | GN | ↓ mm | ltr. | cm | pcs |
|-------|---------|------|------|--------------|-----|
| 81850 | 1/2 | 65 | 4 | 32,5 x 26,5 | 1 |
| | 1/4 | 65 | 1,8 | 26,40 x 16,2 | 2 |
| | Adapter | | | 31,5 | 1 |

**GN-Deckel**

GN-lid
GN tapa
GN couvercle

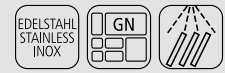
**ohne Löffelaussparung**

without notched edge for spoons
sin agujero para cucharón
sans espace pour louche

| | GN | cm |
|-------|-----|-------------|
| 81195 | 1/1 | 53,0 x 32,5 |
| 81295 | 1/2 | 32,5 x 26,5 |
| 81395 | 1/3 | 32,5 x 17,6 |
| 81495 | 1/4 | 26,5 x 16,2 |
| 81695 | 1/6 | 17,6 x 16,2 |
| 81591 | 1/9 | 17,6 x 10,8 |
| 81795 | 2/3 | 35,4 x 32,5 |
| 81895 | 2/4 | 53,0 x 16,2 |

**GN-Deckel**

GN-lid
GN tapa
GN couvercle

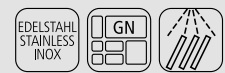
**mit Löffelaussparung**

with notched edge for spoons
con agujero para cucharón
avec espace pour louche

| | GN | cm |
|-------|-----|-------------|
| 81191 | 1/1 | 53,0 x 32,5 |
| 81292 | 1/2 | 32,5 x 26,5 |
| 81391 | 1/3 | 32,5 x 17,6 |
| 81492 | 1/4 | 26,5 x 16,2 |
| 81692 | 1/6 | 17,6 x 16,2 |
| 81595 | 1/9 | 17,6 x 10,8 |
| 81791 | 2/3 | 35,4 x 32,5 |
| 81891 | 2/4 | 53,0 x 16,2 |



Die Löffelaussparung mit Prägung verhindert das Zurückfließen von Flüssigkeit auf dem Deckel in den Behälter.

The notch for spoon with embossing prevents liquid on the lid from flowing back into the container.

GN-CONTAINERS



GN Transport-Steck-Deckel

GN-lid with silicone seal
GN tapa hermética con junta
GN couvercle hermétique avec joint



Silikondichtung, Griffmulde und Loch gegen Unterdruck, schwappsicherer Transport nicht für Kombidämpfer geeignet

silicone joint, flat handle, vent to compensate, slosh-proof transport, for pressure, not usable for steam oven
junta de silicona, asa empotrada, válvula para compensar, transporte sin salpicaduras, la presión, no se puede utilizar en hornos de vapor
joint silicone, anse encastrée, valve pour compenser la pression, transport sans éclaboussures, ne convient pas pour les étuves combinées

| | GN | cm |
|-------|-----|-------------|
| 80023 | 1/1 | 53,0 x 32,5 |
| 80024 | 1/2 | 32,5 x 26,5 |
| 80025 | 1/3 | 32,5 x 17,6 |
| 80026 | 1/4 | 26,5 x 16,2 |
| 80027 | 1/6 | 17,6 x 16,2 |
| 80028 | 2/4 | 53,0 x 16,2 |
| 80029 | 2/3 | 35,4 x 32,5 |



Adapter / Zwischensteg

adapter
adaptador
adaptateur



ermöglicht stabilen Halt von GN-Behältern im CD, rostfreier Chrom-Nickel-Edelstahl

for fixing GN pans, chrome / nickel stainless steel
para sujetar las cubetas GN, acero inox
support stable pour les bacs GN

| | cm | |
|-------|------|---|
| 81996 | 15,9 | längs bei GN 1/4 / lengthwise GN 1/4 longitud GN 1/4 / GN 1/4 dans la longueur |
| 81997 | 17,6 | längs bei GN 1/9 / lengthwise GN 1/9 longitud GN 1/9 / GN 1/9 dans la longueur |
| 81999 | 32,5 | quer bei GN 1/2 / crosswise GN 1/2 de ancho GN 1/2 / GN 1/2 dans la largeur |
| 81998 | 52,5 | längs bei GN 1/1 / lengthwise GN 1/1 longitud GN 1/1 / GN 1/1 dans la longueur |



GN Abtropfgitter

GN-drainer
GN escurridor
GN égouttoir



Abtropfgitter aus Edelstahl für Gastronorm Behälter, passend für GN 1/1 und GN 1/2

stainless steel GN drainer for GN 1/1 + GN 1/2
escurridor GN de acero inoxidable para GN 1/1 + GN 1/2
égouttoir GN en acier inoxydable pour GN 1/1 + GN 1/2

| | GN | cm | ↑ cm |
|-------|-----|---------|------|
| 81117 | 1/1 | 45 x 25 | 1,5 |
| 81118 | 1/2 | 25 x 19 | 1,5 |



GN-Behälter aus Polypropylen

GN-container polypropylene
GN cubetas polipropileno
GN bacs polypropilène



transparent: Skalierung in Liter, robust und formstabil

transparent: liter scale, solid quality

transparente: graduación en litros, alta calidad

transparent: graduation en litres, haute-qualité

| | GN | ↓ mm | ltr. | cm |
|-------|-----|------|------|-----------|
| 82104 | 1/1 | 65 | 8,5 | 53 x 32,5 |
| 82106 | 1/1 | 100 | 13,0 | 53 x 32,5 |
| 82108 | 1/1 | 150 | 19,5 | 53 x 32,5 |
| 82110 | 1/1 | 200 | 26,0 | 53 x 32,5 |

| | GN | ↓ mm | ltr. | cm |
|-------|-----|------|------|-------------|
| 82112 | 1/2 | 65 | 3,9 | 32,5 x 26,5 |
| 82114 | 1/2 | 100 | 5,9 | 32,5 x 26,5 |
| 82116 | 1/2 | 150 | 8,9 | 32,5 x 26,5 |
| 82117 | 1/2 | 200 | 11,8 | 32,5 x 26,5 |

| | GN | ↓ mm | ltr. | cm |
|-------|-----|------|------|-------------|
| 82118 | 1/3 | 65 | 2,4 | 32,5 x 17,5 |
| 82120 | 1/3 | 100 | 3,6 | 32,5 x 17,5 |
| 82122 | 1/3 | 150 | 5,3 | 32,5 x 17,6 |
| 82123 | 1/3 | 200 | 7,0 | 32,5 x 17,6 |

| | GN | ↓ mm | ltr. | cm |
|-------|-----|------|------|-------------|
| 82128 | 1/4 | 65 | 1,7 | 26,5 x 16,2 |
| 82130 | 1/4 | 100 | 2,5 | 26,5 x 16,2 |
| 82132 | 1/4 | 150 | 3,7 | 26,5 x 16,2 |
| 82134 | 1/4 | 200 | 4,8 | 26,5 x 16,2 |

| | GN | ↓ mm | ltr. | cm |
|-------|-----|------|------|-------------|
| 82136 | 1/6 | 65 | 1,0 | 17,6 x 16,2 |
| 82138 | 1/6 | 100 | 1,5 | 17,6 x 16,2 |
| 82140 | 1/6 | 150 | 2,2 | 17,6 x 16,2 |
| 82142 | 1/6 | 200 | 2,8 | 17,6 x 16,2 |

| | GN | ↓ mm | ltr. | cm |
|-------|-----|------|------|-------------|
| 82150 | 1/9 | 65 | 0,6 | 17,6 x 10,8 |
| 82151 | 1/9 | 100 | 1,0 | 17,6 x 10,8 |



stapelbar
stackable

Skalierung
scaling



GN-Deckel

GN-lid
GN tapa
GN couvercle



| | GN | cm |
|-------|-----|-------------|
| 82101 | 1/1 | 53,0 x 32,5 |
| 82113 | 1/2 | 32,5 x 26,5 |
| 82119 | 1/3 | 32,5 x 17,6 |
| 82129 | 1/4 | 26,5 x 16,2 |
| 82137 | 1/6 | 17,6 x 16,2 |
| 82159 | 1/9 | 17,6 x 10,8 |

GN-CONTAINERS



GN-Behälter aus Polycarbonat

GN-container polycarbonate
GN cubeta policarbonato
GN bac polycarbonate

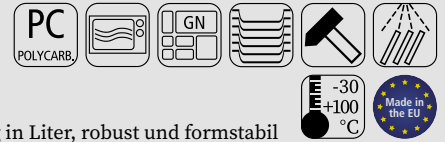

transparent: Inhalt gut erkennbar, Skalierung in Liter, robust und formstabil

transparent: content can be seen, liter scale, solid quality

transparente para ver el contenido, graduación en litros, alta calidad

transparent pour voir le contenu, graduation en litres, haute-qualité

| | GN | ↓ mm | ltr. | cm |
|-------|-----|------|------|-------------|
| 82004 | 1/1 | 65 | 8,5 | 53 x 32,5 |
| 82006 | 1/1 | 100 | 13,0 | 53 x 32,5 |
| 82008 | 1/1 | 150 | 19,5 | 53 x 32,5 |
| 82010 | 1/1 | 200 | 26,0 | 53 x 32,5 |
| | GN | ↓ mm | ltr. | cm |
| 82012 | 1/2 | 65 | 3,9 | 32,5 x 26,5 |
| 82014 | 1/2 | 100 | 5,9 | 32,5 x 26,5 |
| 82016 | 1/2 | 150 | 8,9 | 32,5 x 26,5 |
| 82017 | 1/2 | 200 | 11,8 | 32,5 x 26,5 |
| | GN | ↓ mm | ltr. | cm |
| 82018 | 1/3 | 65 | 2,4 | 32,5 x 17,6 |
| 82020 | 1/3 | 100 | 3,6 | 32,5 x 17,6 |
| 82022 | 1/3 | 150 | 5,3 | 32,5 x 17,6 |
| 82023 | 1/3 | 200 | 7,0 | 32,5 x 17,6 |
| | GN | ↓ mm | ltr. | cm |
| 82028 | 1/4 | 65 | 1,7 | 26,5 x 16,2 |
| 82030 | 1/4 | 100 | 2,5 | 26,5 x 16,2 |
| 82032 | 1/4 | 150 | 3,7 | 26,5 x 16,2 |
| 82034 | 1/4 | 200 | 4,8 | 26,5 x 16,2 |
| | GN | ↓ mm | ltr. | cm |
| 82036 | 1/6 | 65 | 1,0 | 17,6 x 16,2 |
| 82038 | 1/6 | 100 | 1,5 | 17,6 x 16,2 |
| 82040 | 1/6 | 150 | 2,2 | 17,6 x 16,2 |
| 82042 | 1/6 | 200 | 2,8 | 17,6 x 16,2 |
| | GN | ↓ mm | ltr. | cm |
| 82050 | 1/9 | 65 | 0,6 | 17,6 x 10,2 |
| 82051 | 1/9 | 100 | 1,0 | 17,6 x 10,2 |



GN-Deckel

GN-lid
GN tapa
GN couvercle



| | GN | cm |
|-------|-----|-------------|
| 82001 | 1/1 | 53,0 x 32,5 |
| 82013 | 1/2 | 32,5 x 26,5 |
| 82019 | 1/3 | 32,5 x 17,6 |
| 82029 | 1/4 | 26,5 x 16,2 |
| 82037 | 1/6 | 17,6 x 16,2 |
| 82059 | 1/9 | 17,6 x 10,8 |



GN Abtropfgitter

GN drainer
GN escurridor
GN égouttoir



| | für GN | cm |
|-------|--------|-------------|
| 82003 | 1/1 | 47,3 x 26,8 |
| 82005 | 1/2 | 26,8 x 20,8 |
| 82007 | 1/3 | 26,8 x 11,8 |

NEW

BLACK GN CONTAINER



NEW



82065 GN 1/2 | 100 mm



82069 GN 1/3 | 100 mm



82073 GN 1/4 | 100 mm



82077 GN 1/6 | 100 mm



82081 GN 1/9 | 100 mm

GN-Behälter aus Polycarbonat

GN-container polycarbonate

GN cubetas polycarbonato

GN bacs polycarbonate

schwarz: Skalierung in Liter, robust und formstabil

black: liter scale, solid quality

negro: graduación en litros, alta calidad

noir : graduation en litres, haute-qualité



| | GN | ↓ mm | ltr. | cm |
|-------|-----|------|------|-------------|
| 82064 | 1/2 | 65 | 3,9 | 32,5 x 26,5 |
| 82065 | 1/2 | 100 | 5,9 | 32,5 x 26,5 |
| 82066 | 1/2 | 150 | 8,9 | 32,5 x 26,5 |
| | GN | ↓ mm | ltr. | cm |
| 82068 | 1/3 | 65 | 2,4 | 32,5 x 17,6 |
| 82069 | 1/3 | 100 | 3,6 | 32,5 x 17,6 |
| 82070 | 1/3 | 150 | 5,3 | 32,5 x 17,6 |
| | GN | ↓ mm | ltr. | cm |
| 82072 | 1/4 | 65 | 1,7 | 26,5 x 16,2 |
| 82073 | 1/4 | 100 | 2,5 | 26,5 x 16,2 |
| 82074 | 1/4 | 150 | 3,7 | 26,5 x 16,2 |
| | GN | ↓ mm | ltr. | cm |
| 82076 | 1/6 | 65 | 1,0 | 17,6 x 16,2 |
| 82077 | 1/6 | 100 | 1,5 | 17,6 x 16,2 |
| 82078 | 1/6 | 150 | 2,2 | 17,6 x 16,2 |
| | GN | ↓ mm | ltr. | cm |
| 82081 | 1/9 | 100 | 1,0 | 17,6 x 10,8 |

passende Deckel, S. 358
suitable lid, page 358stapelbar
stackable

GN-CONTAINERS



Backblech

baking sheet
bandeja pastelera
plaque à pâtisserie



geloht Ø 3 mm, Materialstärke 1,5 mm, Silikon beschichtet, temperaturbeständig bis 240°C
perforated Ø 3 mm, coated with silicon, heat resistant up to 240°C
aluminio con revestimiento de silicona perforada, resistente hasta 240°
aluminium avec revêtement silicone, perforée, température maxi 240°

| | GN | cm |
|-------|-----|-----------|
| 88285 | 1/1 | 53 x 32,5 |

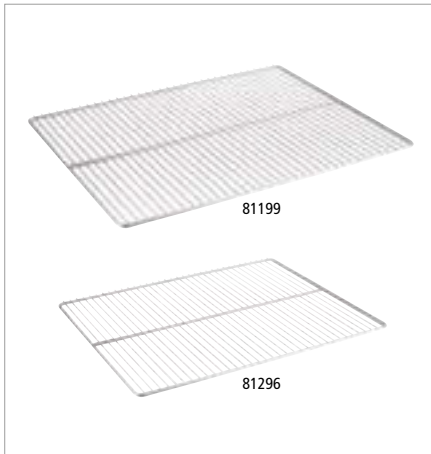

GN Roste

GN grid
GN rejilla
GN grille



elektrolytisch poliert, Drahtstärke 3 mm, Rahmendraht 6 mm, extra schwere Qualität
electro-polished, wire thickness 3 mm, frame wire 6 mm, extra heavy quality
inox pulido electrolítico, grosor alambre 3 mm, grosor marco 6 mm, calidad reforzada
inox poli électrolytique, fil 3 mm, cadre 6 mm, qualité renforcée

| | GN | cm |
|-------|-----|-------------|
| 81199 | 2/1 | 65,0 x 53,0 |
| 81198 | 1/1 | 53,0 x 32,5 |
| 81796 | 2/3 | 32,5 x 35,4 |
| 81296 | 1/2 | 32,5 x 26,5 |



GN 1/3 Bestecksammler

GN 1/3 container
GN 1/3 cubeta
GN 1/3 bac



mit 2 Haken zum Einhängen an Servier- oder Transportwagen
container with 2 hooks, to hang on trolleys for cutlery
cubeta con 2 ganchos para cubiertos, a colgar del carro
bac à couverts avec 2 crochets, à accrocher au chariot

| | GN | ↓ mm | cm |
|-------|-----|------|-------------|
| 11978 | 1/3 | 150 | 32,5 x 17,5 |



GN Tablett „FRAMES“

GN tray
GN bandeja
GN plateau



| | GN | ↑ cm | cm |
|-------|-----|------|-------------|
| 82355 | 1/1 | 2 | 53,0 x 32,5 |
| 82356 | 1/2 | 2 | 32,5 x 26,5 |
| 82357 | 1/3 | 2 | 32,5 x 17,6 |



PORCELAIN GN CONTAINERS



GN-Behälter
GN-container
GN cubetas
GN bac



| | GN | ↓ mm | ltr. | cm |
|-------|-----|------|------|-------------|
| 82100 | 1/1 | 60 | 7,1 | 53,0 x 32,5 |
| 82200 | 1/2 | 60 | 3,4 | 32,5 x 26,5 |
| 82300 | 1/3 | 60 | 2,0 | 32,5 x 17,6 |
| 82306 | 2/3 | 60 | 4,6 | 35,4 x 32,5 |
| 82301 | 2/4 | 60 | 3,0 | 53,0 x 16,2 |



GN-Behälter
GN-container
GN cubetas
GN bac



| | GN | ↓ mm | ltr. | cm | Farbe / colour |
|-------|-----|------|------|-------------|----------------|
| 82270 | 1/1 | 60 | 7,1 | 53,0 x 32,5 | Yellow |
| 82271 | 1/1 | 60 | 7,1 | 53,0 x 32,5 | Green |
| 82272 | 1/1 | 60 | 7,1 | 53,0 x 32,5 | Red |
| 82273 | 1/1 | 60 | 7,1 | 53,0 x 32,5 | Black |
| 82274 | 1/2 | 60 | 3,4 | 32,5 x 26,5 | Yellow |
| 82275 | 1/2 | 60 | 3,4 | 32,5 x 26,5 | Green |
| 82276 | 1/2 | 60 | 3,4 | 32,5 x 26,5 | Red |
| 82277 | 1/2 | 60 | 3,4 | 32,5 x 26,5 | Black |
| 82278 | 1/3 | 60 | 2,0 | 32,5 x 17,6 | Yellow |
| 82279 | 1/3 | 60 | 2,0 | 32,5 x 17,6 | Green |
| 82280 | 1/3 | 60 | 2,0 | 32,5 x 17,6 | Red |
| 82281 | 1/3 | 60 | 2,0 | 32,5 x 17,6 | Black |



Präsentationsmöglichkeit
presentation example

GN-CONTAINERS



GN-Behälter „ECOLINE“

GN container

GN cubeta

GN bac

mit Stapelnocke

with notching edge

con borde marcado para el apilado

avec rebord pour l'empilage



| | GN | ↓ mm | ltr. | cm | Farbe / Colour |
|-------|-----|------|------|-------------|----------------|
| 83759 | 1/1 | 65 | 7,10 | 53,0 x 32,5 | White |
| 83755 | 2/4 | 65 | 3,00 | 53,0 x 16,2 | White |
| 83757 | 1/2 | 65 | 3,40 | 32,5 x 26,5 | White |
| 83753 | 1/3 | 65 | 2,00 | 32,5 x 17,6 | White |
| 83751 | 1/4 | 65 | 1,35 | 26,5 x 16,2 | White |
| 83749 | 1/6 | 65 | 0,80 | 17,6 x 16,2 | White |

| | GN | ↓ mm | ltr. | cm | Farbe / Colour |
|-------|-----|------|------|-------------|----------------|
| 83758 | 1/1 | 65 | 7,10 | 53,0 x 32,5 | Black |
| 83754 | 2/4 | 65 | 3,00 | 53,0 x 16,2 | Black |
| 83756 | 1/2 | 65 | 3,40 | 32,5 x 26,5 | Black |
| 83752 | 1/3 | 65 | 2,00 | 32,5 x 17,6 | Black |
| 83750 | 1/4 | 65 | 1,35 | 26,5 x 16,2 | Black |
| 83748 | 1/6 | 65 | 0,80 | 17,6 x 16,2 | Black |

| | GN | ↓ mm | ltr. | cm | Farbe / Colour |
|-------|-----|------|------|-------------|----------------|
| 84300 | 1/1 | 100 | 10,6 | 53,0 x 32,5 | White |
| 84302 | 2/4 | 100 | 4,3 | 53,0 x 16,2 | White |
| 84301 | 1/2 | 100 | 4,7 | 32,5 x 26,5 | White |
| 84303 | 1/3 | 100 | 2,7 | 32,5 x 17,6 | White |
| 84304 | 1/4 | 100 | 1,9 | 26,5 x 16,2 | White |
| 84305 | 1/6 | 100 | 1,0 | 17,6 x 16,2 | White |

| | GN | ↓ mm | ltr. | cm | Farbe / Colour |
|-------|-----|------|------|-------------|----------------|
| 84306 | 1/1 | 100 | 10,6 | 53,0 x 32,5 | Black |
| 84308 | 2/4 | 100 | 4,3 | 53,0 x 16,2 | Black |
| 84307 | 1/2 | 100 | 4,7 | 32,5 x 26,5 | Black |
| 84309 | 1/3 | 100 | 2,7 | 32,5 x 17,6 | Black |
| 84310 | 1/4 | 100 | 1,9 | 26,5 x 16,2 | Black |
| 84311 | 1/6 | 100 | 1,0 | 17,6 x 16,2 | Black |



GN-Deckel

GN-lid

GN tapa

GN couvercle



| | GN | cm |
|-------|-----|-------------|
| 82001 | 1/1 | 53,0 x 32,5 |
| 82013 | 1/2 | 32,5 x 26,5 |
| 82019 | 1/3 | 32,5 x 17,6 |
| 82029 | 1/4 | 26,5 x 16,2 |
| 82037 | 1/6 | 17,6 x 16,2 |



83762

83763

GN-Behälter „HIGHLINE“

GN-container

GN cubeta

GN bac

mit Stapelnocke

with notching edge

con borde marcado para el apilado

avec rebord pour l'empilage



| | GN | ↓ mm | ltr. | cm |
|-------|-----|------|------|-------------|
| 83772 | 1/1 | 65 | 7,10 | 53,0 x 32,5 |
| 83768 | 1/2 | 65 | 3,40 | 32,5 x 26,5 |
| 83766 | 2/4 | 65 | 3,00 | 53,0 x 16,2 |
| 83764 | 1/3 | 65 | 2,00 | 32,5 x 17,6 |
| 83762 | 1/4 | 65 | 1,35 | 26,5 x 16,2 |
| 83760 | 1/6 | 65 | 0,80 | 17,6 x 16,2 |

| | GN | ↓ mm | ltr. | cm |
|-------|-----|------|------|-------------|
| 83773 | 1/1 | 100 | 11,0 | 53,0 x 32,5 |
| 83769 | 1/2 | 100 | 5,50 | 32,5 x 26,5 |
| 83765 | 1/3 | 100 | 3,15 | 32,5 x 17,6 |
| 83763 | 1/4 | 100 | 2,20 | 26,5 x 16,2 |
| 83761 | 1/6 | 100 | 1,25 | 17,6 x 16,2 |



83768



83401

83479

Tablett „PURE“

tray

bandeja

plateau



| | cm | ↑ cm | GN | Farbe / Colour |
|-------|-------------|------|-----|----------------|
| 83401 | 53,0 x 32,5 | 3 | 1/1 | White |
| 83433 | 53,0 x 16,2 | 3 | 2/4 | White |
| 83480 | 32,5 x 26,5 | 3 | 1/2 | White |
| 83481 | 32,5 x 17,6 | 3 | 1/3 | White |
| 83482 | 26,5 x 16,2 | 3 | 1/4 | White |

83597 40,0 x 30,0 3 Bäcker-Maß White

| | cm | ↑ cm | GN | Farbe / Colour |
|-------|-------------|------|-----|----------------|
| 83479 | 53,0 x 32,5 | 3 | 1/1 | Black |
| 83434 | 53,0 x 16,2 | 3 | 2/4 | Black |
| 83490 | 32,5 x 26,5 | 3 | 1/2 | Black |
| 83491 | 32,5 x 17,6 | 3 | 1/3 | Black |
| 83492 | 26,5 x 16,2 | 3 | 1/4 | Black |

83592 40,0 x 30,0 3 Bäcker-Maß Black

SERVING TROLLEYS



Servier- / Transportwagen

serving trolley
carro de servicio
chariot de service



Gestell aus Vierkantrohr 25 x 25 mm, Ablagefläche innen 84 x 44,5 cm, Bodenfläche 90 x 50 cm, auf Unterseite schalldämmend beschichtet, Abstand zwischen den Böden 28 cm / 29 cm, mit 4 Lenkrollen Ø 12,5 cm, alle mit Feststellern, Lieferung demontiert, einfache Montage, Tragfähigkeit 33 kg je Boden

frame rectangular bar 25 x 25 mm, shelf board inside 84 x 44,5 cm, shelf board outside 90 x 50 cm, undersurface coated sound-damping, distance between the boards 28 cm / 29 cm, with 4 swivel wheels Ø 12,5 cm, all with brakes, unassembled, simple assembly, max load 33 kg per shelf

estructura tubo cuadrado 25 x 25 mm, útiles int. por piso 84 x 44,5 cm. ext. al suelo 90 x 50 cm revestimiento para absorber ruidos distancia entre pisos 28 cm / 29 cm, 4 ruedas giratorias 12,50 cm, con frenos, se sirve desmontado, montaje fácil, carga máx. 33 kg por piso

structure en tube carré 25x25 mm, 3 niveaux dimensions utiles 84x44,5 cm, encombrement au sol 90x50 cm, avec revêtement en partie inférieure pour absorber le bruit, distance entre niveaux 28 cm / 29 cm, roues pivotantes 12,5 cm, avec frein, livré démonté, montage aisé, max. 33 kg de charge par niveau

| | cm | ↑ cm |
|-------|---------|------|
| 71440 | 96 x 50 | 94 |



Servier- / Transportwagen

service trolley
carro de servicio
chariot de service



mit 3 Borden, Bordmaße ca. 83 x 51 cm, Abstand zwischen den Borden ca. 26 cm, Tragfähigkeit 120 kg, 4 Lenkrollen, davon 2 feststellbar, Lieferung demontiert, einfache Montage

with 3 trays, trays approx. 83 x 51 cm, size between the trays approx. 26 cm, total load capacity 120 kg, 4 wheels with 2 brakes, unassembled, simple assembly

con 3 bandejas inox mate, aprox. 83 x 51 cm, la medida entre bandejas aprox. 26 cm capacidad total 120 kg, 4 ruedas con 2 frenos, construcción robusta, montaje fácil

3 niveaux, approx. 83x51 cm chacun, distance entre niveaux 26 cm, capacité maxi 120 kg au total, 4 roues dont 2 avec frein, construction robuste, montage facile

| | cm | ↑ cm |
|-------|---------|------|
| 11979 | 91 x 59 | 93 |



Servier- / Transportwagen

service trolley
carro de servicio
chariot de service



mit 2 Borden, Bordmaße ca. 83 x 51 cm, Abstand zwischen den Borden ca. 56 cm, Tragfähigkeit 80 kg, 4 Lenkrollen, davon 2 feststellbar, Lieferung demontiert, einfache Montage

with 2 trays, trays approx. 83 x 51 cm, size between the trays approx. 56 cm, total load capacity 80 kg, 4 wheels with 2 brakes, unassembled, simple assembly

con 2 bandejas de acero inoxidable mate, aprox. 83 x 51 cm, la medida entre bandejas aprox. 56 cm, capacidad total 80 kg, 4 ruedas, con 2 frenos, construcción robusta, montaje fácil

2 niveaux, approx. 83x51 cm chacun, distance entre niveaux 56 cm, capacité maxi 80 kg au total, 4 roues dont 2 avec frein, construction robuste, montage facile

| | cm | ↑ cm |
|-------|---------|------|
| 11977 | 91 x 59 | 93 |

**Servier- / Transportwagen**

serving trolley
carro de servicio
chariot de service



Aluminiumrahmen, 3 Böden, Abstand zwischen den Böden 31 cm, mit 4 Lenkrollen, alle mit Feststellern, Tragfähigkeit: ca. 50 kg je Boden, 150 kg insgesamt, demontiert, einfache Montage, Lieferung ohne Container und Dekoration

frame aluminium, 3 shelves, distance between shelves 31 cm, 4 swivel wheels, all equipped with brakes, max. load per shelf 50 kg, 150 kg total, demounted, easy to mount, delivery without containers and decoration

marco aluminio, 3 pisos, distancia entre cada piso 31 cm, 4 ruedas giratorias, las 4 con frenos, carga máxima por bandeja 50 kg, 150 kg en total, se sirve desmontado, fácil de montar (se entrega sin contenedores ni decoración)

chassis aluminium, 3 étages, distance entre niveaux 31 cm, 4 roues pivotantes, toutes avec frein, charge maximum 50 kg par niveau, 150 kg au total, livré démonté, montage facile (livré sans récipients ni décoration)

| | cm | ↑ cm | |
|-------|----------|------|--------------------|
| 11945 | 108 x 50 | 96 | without containers |

Container zum Einhängen, passend zum Servier- / Transportwagen 11945

container to hang up, suitable serving trolley 11945
contenedor para colgar, adaptado para el carro ref. 11945
récipient à suspendre, pour chariot de service 11945



| | cm | ↑ cm | ltr. |
|-------|---------|------|------|
| 11946 | 33 x 23 | 56,5 | 42 |
| 11947 | 33 x 23 | 17,5 | 13 |

**GN 1/1 Regalwagen**

GN 1/1 trolley
GN 1/1 carro
GN 1/1 chariot



mit 15 Doppelauflegeschieben, zum Transport von bis zu 30 GN-Tablets GN 1/2 oder 15 GN-Behältern bis GN 1/1 (Längseinschub), bei einem Stapelabstand von 75 mm, mit 4 Lenkrollen, 2 mit Feststellern, Tragfähigkeit 100 kg

15 double bars, for transporting up to 30 trays GN 1/2 or 15 GN containers up to GN 1/1 (lengthwise insertion), size between the trays 75 mm, with 4 swivel wheels, 2 with brakes, max. load 100 kg

15 raíles de soporte dobles, para transportar hasta 30 bandejas GN 1/2 o 15 cubetas GN hasta GN 1/1 (inserción longitudinal), distancia entre las bandejas de 75 mm, con 4 ruedas giratorias, 2 con freno, carga máxima de 100 kg

15 doubles rails de support, pour transporter jusqu'à 30 plateaux GN 1/2 ou 15 bacs GN jusqu'à GN 1/1 (insertion longitudinale), distance entre les plateaux 75 mm, avec 4 roues pivotantes, 2 avec frein, capacité de charge 100 kg

| | cm | ↑ cm |
|-------|-----------|-------|
| 71441 | 55 x 38,5 | 173,5 |



mit beidseitiger Kipp- und Durchschubsicherung
with tilt and push-through protection on both sides

CUTLERY BOXES



Besteckbehälter

cutlery box
recipiente para cubiertos
réceptif pour couverts

Akazienholz, 4 Fächer (26 x 11,5 cm)

acacia wood, 4 compartments (26 x 11,5 cm)
madera de acacia, 4 compartimentos (26 x 11,5 cm)
bois d'acacia, 4 compartiments (26 x 11,5 cm)



| | cm | ↑ cm | Farbe / Colour | |
|-------|---------|------|----------------|---------------|
| 11952 | 51 x 28 | 13 | | nature |
| 11951 | 51 x 28 | 13 | | vintage white |



Besteckbehälter mit Deckel

cutlery box with cover
caja de cubiertos con tapa
range-couverts avec couvercle

Akazienholz, 4 Fächer (26 x 11,5 cm), mit Deckel

acacia wood, 4 compartments (26 x 11,5 cm), with cover
madera de acacia, 4 compartimentos (26 x 11,5 cm), con tapa
bois d'acacia, 4 compartiments (26 x 11,5 cm), avec couvercle



| | cm | ↑ cm | Farbe / Colour | |
|-------|---------|------|----------------|---------------|
| 11949 | 51 x 28 | 14,5 | | nature |
| 11948 | 51 x 28 | 14,5 | | vintage white |



GN 1/1 Besteckbehälter

GN 1/1 dispenser GN
GN 1/1 dispensador de cubiertos
GN 1/1 bac à couverts

in Handarbeit geflochten, 4 Mulden, Kunststoff-Geflecht, Drahtgestell, braun-schwarz

hand-woven, 4 troughs, plastic wickerwork, wire frame, brown-black
cesta trensada a mano, 4 compartimentos, mimbre de plástico, marco de alambre, marrón-negro
corbeille tressée à main, 4 compartiments, plastique tressé, armature en fil métallique, brun-noir



| | cm | ↑ cm | Farbe / Colour | GN |
|-------|-----------|------|----------------|-----|
| 11966 | 53 x 32,5 | 9 | | 1/1 |



GN 1/1 Besteckbehälter

GN 1/1 cutlery dispenser
GN 1/1 dispensador de cubiertos
GN 1/1 bac à couverts

4 Mulden, Kunststoff-Geflecht, Drahtgestell, beige

4 troughs, plastic wickerwork, wire frame, beige
4 compartimentos, mimbre de plástico, marco de alambre, beige
4 compartiments, plastique tressé, structure métallique, beige



| | cm | ↑ cm | Farbe / Colour | GN |
|-------|-----------|------|----------------|-----|
| 11965 | 53 x 32,5 | 10 | | 1/1 |



GN 1/1 Besteckbehälter

GN 1/1 cutlery bin
GN 1/1 recipiente para cubiertos
GN 1/1 récipients pour couverts



4 Mulden

4 troughs
4 compartimentos
4 compartments

| | cm | ↑ cm | Farbe / Colour | GN |
|-------|-----------|------|----------------|-----|
| 11954 | 53 x 32,5 | 10 | ■ | 1/1 |
| 11955 | 53 x 32,5 | 10 | ■ | 1/1 |

3 Mulden, 3 Köcher

3 troughs, 3 cutlery baskets
3 compartimentos, 3 cestas para cubiertos
3 compartiments, 3 corbeilles à couverts

| | cm | ↑ cm | Farbe / Colour | GN |
|-------|-----------|------|----------------|-----|
| 11960 | 53 x 32,5 | 10 | ■ | 1/1 |



Besteckbehälter

cutlery basket
recipiente para cubiertos
récipients pour couverts



4 Löcher inklusive 4 Edelstahl Köcher

4 holes including 4 stainless baskets
4 agujeros con 4 cestas de acero inoxidable
4 trous avec 4 corbeilles en acier inox

| | cm | ↑ cm | Farbe / Colour |
|-------|---------|------|----------------|
| 93321 | 27 x 27 | 15 | ■ |



Besteckköcher

cutlery basket
cesta para cubiertos
corbeille à couverts



Polyethylen weiß / polyethylene white plastic / polietileno blanco / polyéthylène blanc

| | Ø cm | ↑ cm |
|-------|------|------|
| 11998 | 9,5 | 13,5 |

Edelstahl matt poliert / stainless steel matt polished / acero inoxidable pulido mate / acier inox poli mat

| | Ø cm | ↑ cm |
|-------|------|------|
| 11999 | 9,5 | 13,5 |



Besteckkasten „INDUSTRIAL“

cutlery box
caja para cubiertos
boîte pour couverts



schwarz, mit Beschriftungsfach 6,5 x 2,5 cm

black, with labelling compartment 6,5 x 2,5 cm
negro, con compartimento de etiquetado 6,5 x 2,5 cm
noir, avec compartiment pour l'étiquetage 6,5 x 2,5 cm

| | cm | ↑ cm | ltr. |
|-------|-------------|------|------|
| 40676 | 23,0 x 15,5 | 13,0 | 2,4 |



Teig- und Pizzaballenbehälter
dough and pizza ball container
recipiente para masa y bolas de pizza
réipient à pâte et boules à pizza



Innenmaß 56,5 x 36,5 cm, H: 6,5 cm
inner dimension 56,5 x 36,5 cm, H: 6,5 cm
medida interior 56,5 x 36,5 cm, H: 6,5 cm
dimension intérieure 56,5 x 36,5 cm, H: 6,5 cm

| | cm | ↑ cm | ltr. |
|-------|---------|------|------|
| 82440 | 60 x 40 | 7 | 13 |



stapelbar
stackable

passender Deckel / fitting lid / tapa adecuada / couvercle approprié

| | cm | ↑ cm | |
|-------|---------|------|--|
| 82441 | 60 x 40 | 1 | |



Eier-Box
eggs box
caja para huevos
boîte à oeufs



mit luftdichtem Deckel, für 4 Lagen à 30 Eier, Lieferung inkl. 8 Lagen, Größe Lage: 28 x 28 cm
with airtight cover, capacity: 4 trays of 30 eggs, delivery with 8 trays, size of tray: 28 x 28 cm
capacidad para 4 bandejas de 30 huevos, tapa hermética, se entrega con 8 bandejas, formato bandejas 28 x 28 cm, apto para lavavajillas
pour 4 plateaux de 30 oeufs chacun, apte pour 4 plateaux plats, couvercle hermétique, livré avec 8 plateaux, dimension plateau 28x28 cm, lavable en lave-vaisselle

| | cm | ↑ cm | GN |
|-------|-------------|------|-----|
| 82419 | 35,4 x 32,5 | 20 | 2/3 |

10 Lagen / 10 trays / 10 bandejas / 10 plateaux

82420



25 ltr.

Wanne
container
cubeta
bac



| | cm | ↑ cm | ltr. |
|-------|---------|------|------|
| 11940 | 61 x 44 | 15 | 25 |



20 ltr.

Wanne
container
cubeta
bac



| | cm | ↑ cm | ltr. |
|-------|---------|------|------|
| 11950 | 55 x 42 | 14 | 20 |



Profi-Eimer
bucket
cubo
seau



mit Ausgießer und geprägter Maßskalierung innen
with spout and embossed dimension scaling inside
con pico y escala de medición en relieve en el interior
avec bec verseur et échelle de mesure en relief à l'intérieur

| | Ø cm | ↑ cm | ltr. | Farbe / Colour |
|-------|------|------|------|----------------|
| 30075 | 28,5 | 28,5 | 10,5 | White |
| 30076 | 33,0 | 32,0 | 17,0 | White |
| 30077 | 28,5 | 28,5 | 10,5 | Black |
| 30078 | 33,0 | 32,0 | 17,0 | Black |



mit Griff
with handle



Maßskalierung innen
dimension scaling inside



Auslaufnase für sicheres Handling
discharge nose for safe handling



Trichter „PROFI“
funnel
embudo
entonnoir



mit Öse
with eyelet
con ojal
avec œillet

| | Ø cm | Ø mm Durchlass | |
|-------|------|----------------|---------------------------|
| 30065 | 6 | 8 | |
| 30066 | 8 | 11 | |
| 30067 | 10 | 12 | |
| 30068 | 12 | 12 | |
| 30069 | 14 | 15 | |
| 30070 | 17 | 17 | mit Sieb / incl. strainer |
| 30071 | 21 | 20 | mit Sieb / incl. strainer |



erleichtert das Einfüllen
facilitates filling



Anwendungsmöglichkeit
applicability



mit einsetzbarem Sieb
incl. insertable strainer



Bar, Café Drinkware

| | |
|---------------------------------|-----|
| BOTTLE COOLERS..... | 372 |
| BEVERAGE DISPENSERS..... | 383 |
| DRINKING CUPS..... | 385 |
| MOSCOW MULE..... | 388 |
| COOL MUGS..... | 391 |
| PINEAPPLE MUGS..... | 392 |
| JULEP MUGS..... | 393 |
| MINI FIRE PUNCH BOWL SETS..... | 394 |
| SHAKERS..... | 395 |
| JIGGERS..... | 397 |
| BAR SPOONS..... | 399 |
| BAR STRAINERS..... | 400 |
| MUDDLERS..... | 402 |
| LEMON SQUEEZERS..... | 403 |
| ICE CUBE MAKERS..... | 404 |
| ICE BUCKETS..... | 405 |
| TONGS..... | 407 |
| STRAWS..... | 408 |
| DRIP MATS..... | 409 |
| CONFERENCE BOTTLE COOLER..... | 410 |
| POURERS..... | 411 |
| CORKSKREWS BARBLADES..... | 413 |
| BARISTA..... | 414 |
| TEAPOTS..... | 419 |
| TRAYS..... | 420 |
| FAST FOOD TRAYS..... | 425 |
| BILL PRESENTERS CRUMBERS..... | 426 |
| ASHTRAYS..... | 427 |
| BINS..... | 431 |
| TO GO..... | 432 |

BOTTLE COOLERS

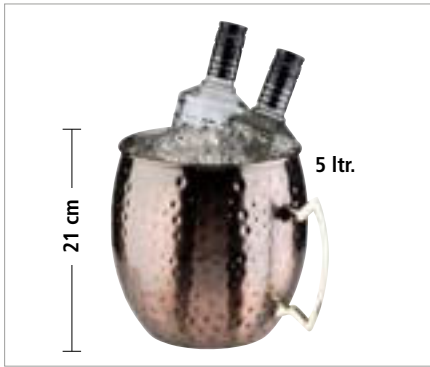

Flaschenkühler „MOSCOW MULE“

bottle cooler
enfriador de botellas
rafraîchisseur de bouteilles

Edelstahl-Flaschenkühler, Antik-Kupfer-Look

stainless steel cooler, copper antique look
enfriador de acero inoxidable, cobre estilo antiguo
rafraîchisseur en acier inox, cuivre style antique



| | Ø cm | ↑ cm | ltr. | |
|-------|------|------|------|-------------------------|
| 93330 | 20 | 21 | 5 | copper-antique-hammered |



Wein- / Sektkühler

wine / champagne bowl
cubitera para vino y cava
seau à vin ou champagne



schwarz matt, mit 2 Griffen, extra stabiler eingerollter Rand

black matt, with 2 handles, rolled edge
negro mate, con 2 asas, borde redondeado
noir mat, avec 2 poignées, bord arrondi

| | Ø cm | ↑ cm | ltr. |
|-------|-----------|------|------|
| 36115 | 21,5 / 15 | 22 | 5 |



Wein- / Sektkühler

wine / champagne bowl
cubitera para vino y cava
seau à vin ou champagne



innen matt poliert, außen hochglanzpoliert, mit massiven Knopf-Griffen, extra stabiler eingerollter Rand, schwere Ausführung

outside mirror polished, inside matt polished, with solid knob handles, rolled edge, heavy quality
exterior pulido brillante, interior pulido mate, asas de botón robustas, borde redondeado, alta calidad

extérieur poli brillant, intérieur poli mat, 2 poignées robuste en forme de bouton, bord arrondi, haute qualité

| | Ø cm | ↑ cm | ltr. |
|-------|-----------|------|------|
| 36028 | 21,5 / 16 | 22 | 4 |



Wein- / Sektkühler „HAMMERSCHLAG“

wine / champagne bowl
cubitera para vino y cava
seau à vin ou champagne



hochglanzpoliert, mit massiven Ring-Griffen, eingerollter Rand

mirror polished, with solid ring handles, rolled edge, hammered
pulido brillante, con 2 anillos macizos, borde redondeado, repujado
brillant, 2 anneaux massifs, bord arrondi, surface martelée

| | Ø cm | ↑ cm | ltr. |
|-------|---------|------|------|
| 36026 | 21 / 17 | 21,5 | 4 |



Wein- / Sektkühler

wine / champagne bowl
cubitera para vino y cava
seau à vin ou champagne



innen matt poliert, außen hochglanzpoliert, mit massiven Griffen, Rand eingerollt

outside mirror polished, inside matt polished, with massive handles, rolled edge
exterior pulido brillante, interior pulido mate, 2 asas macizas, borde redondeado
extérieur poli brillant, intérieur poli mat, 2 anses massives, bord rond

| | Ø cm | ↑ cm | ltr. |
|-------|---------|------|------|
| 36025 | 21 / 15 | 21 | 3,5 |



Wein- / Sektkühler
 wine / champagne bowl
 cubitera para vino y cava
 seau à vin ou champagne
matt poliert, Hohlgriffe
 matt polished, hollow handles
 pulido mate, con asas huecas
 poli mat, 2 boutons creux



| | Ø cm | ↑ cm | litr. |
|-------|---------|------|-------|
| 36021 | 20 / 15 | 20,5 | 4 |



Wein- / Sektkühler
 wine / champagne bowl
 cubitera para vino y cava
 seau à vin ou champagne
aussen hochglanzpoliert, innen matt poliert, mit Ring-Griffen
 outside mirror polished, inside matt polished, with ring handles
 exterior pulido brillante, interior pulido mate, con 2 asas anillos
 extérieur poli brillant, intérieur poli mat, avec 2 anneaux



| | Ø cm | ↑ cm | litr. |
|-------|---------|------|-------|
| 36020 | 20 / 15 | 19 | 3 |



Wein- / Sektkühler
 wine / champagne bowl
 cubitera para vino y cava
 seau à vin ou champagne
glasklarer Rand, transparent gefrostet
 edge transparent, body transparent frosted
 borde transparente, cuerpo transparente efecto glaseado
 bord transparent, corps poli mat



| | Ø cm | ↑ cm | litr. |
|-------|---------|------|-------|
| 36066 | 22 / 14 | 23 | 4 |



Wein- / Sektkühler
 wine / champagne bowl
 cubitera para vino y cava
 seau à vin ou champagne
glasklar, mit Tragegriff
 transparent, handle on the side
 transparente, con un asa en el lateral
 transparent, avec poignée



| | cm | ↑ cm | litr. |
|-------|---------|------|-------|
| 36055 | 23 x 22 | 27,5 | 3 |



Mini-Eiseimer / Mini-Sektkühler
 ice bucket
 cubitera clásica
 seau à glaçons classique



| | Ø cm | ↑ cm | litr. |
|-------|------|------|-------|
| 36003 | 10,5 | 10 | 0,5 |
| 36004 | 13,0 | 13 | 1,0 |

BOTTLE COOLERS



Ständer für Wein- / Sektkühler

stand for wine / champagne bowl
pie porta champañera / vino
ped pour seau à champagne / vin



hochglanzpoliert, schwerer standsicherer Fuß, Innendurchmesser der Schale Ø 17,5 cm
mirror polished, heavy foot, inner bowl Ø 17,5 cm
acabado pulido efecto brillante, bol interior de Ø 17,5 cm
brillant, intérieur support Ø 17,5 cm

| | Ø cm | ↑ cm |
|-------|-------------|------|
| 36069 | 17,5 / 26,5 | 73 |



Wein- / Sektkühler no. 36028

wine / champagne bowl no. 36028
cubitera para vino y cava no. 36028
seau à vin ou champagne no. 36028



Ständer für Wein- / Sektkühler

stand for wine / champagne bowl
pie porta champañera / vino
ped pour seau à champagne / vin



hochglanzpoliert, schwerer standsicherer Fuß, Innendurchmesser der Schale Ø 15 cm
mirror polished, heavy foot, inner bowl Ø 15 cm
acabado pulido efecto brillante, bol interior de Ø 15 cm
brillant, intérieur support Ø 15 cm

| | Ø cm | ↑ cm |
|-------|---------|------|
| 36068 | 15 / 28 | 68 |



Ständer für Wein- / Sektkühler

stand for wine / champagne bowl
pie porta champañera / vino
ped pour seau à champagne / vin



schwarz matt, schwerer standsicherer Fuß, Innendurchmesser der Schale Ø 15 cm
black matt, heavy stable foot, inner bowl Ø 15 cm
negro mate, pie pesado y estable, bol interior de Ø 15 cm
noir mat, pied lourd et stable, intérieur support Ø 15 cm

| | Ø cm | ↑ cm |
|-------|-------------|------|
| 36116 | 19,5 / 26,5 | 71,5 |



36115



36028



Tischhalterung für Sektkühler

champagne bucket table holder
soporte champañera universal
porte-seau à champagne



aus 8 mm starkem Stahldraht, passen zu allen lieferbaren Sektkühlern, innen Ø-Ring: 18 cm
8 mm chrome plated wire, suitable for all available champagne buckets, inner ring Ø 18 cm
alambre cromado 8 mm, para todas las champañeras, anillo interior Ø 18 cm
fil chromé 8 mm, pour tous les seaux à champagne, anneau intérieur Ø 18 cm

| | cm | ↑ cm |
|-------|---------|------|
| 30332 | 49 x 20 | 17 |



Flaschenkühler

bottle cooler
enfriador de botella
rafraîchisseur de bouteille

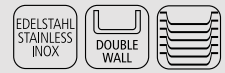

doppelwandig für beste Isolierung, außen Hammerschlag-Optik

double-walled for best insulation, outside: hammered surface
doble pared para un mejor aislamiento, exterior: aspecto martillado
double paroi pour une meilleur isolation, extérieur: surface martelée

| | Ø cm | ↑ cm | ltr. | Farbe / Colour |
|-------|------|------|------|----------------|
| 36120 | 33 | 20 | 8 | stainless |
| 36121 | 33 | 20 | 8 | copper-look |



Präsentationsmöglichkeit
presentation examples



Wein- / Sektkühler „XL“

wine / champagne bowl
cubitera para vino y cava
seau à vin ou champagne



gehämmerte Oberfläche, mit 2 seitlichen Eingriffen

hammered surface, with 2 handles on the side
superficie martillada, con 2 asas
surface martelée, avec 2 poignées

| | cm | ↑ cm | ltr. | Farbe / Colour |
|-------|-----------|------|------|----------------|
| 36111 | 30 x 23,5 | 23 | 7 | copper-look |
| 36112 | 30 x 23,5 | 23 | 7 | gunmetal-look |



Wein- / Sektkühler „LARGE“

wine / champagne bowl
cubitera para vino y cava
seau à vin ou champagne



gehämmerte Oberfläche, mit 2 seitlichen Eingriffen, für 1-2 Flasche

hammered surface, with 2 handles on the side, for 1-2 bottle
superficie martillada, con 2 asas, para 1-2 botellas
surface martelée, avec 2 poignées, pour 1-2 bouteilles

| | cm | ↑ cm | ltr. | Farbe / Colour |
|-------|-----------|------|------|----------------|
| 36108 | 25,5 x 19 | 20 | 3,9 | copper-look |
| 36109 | 25,5 x 19 | 20 | 3,9 | gunmetal-look |



Wein- / Sektkühler „SMALL“

wine / champagne bowl
cubitera para vino y cava
seau à vin ou champagne



gehämmerte Oberfläche, für 1 Flasche

hammered surface, for 1 bottle
superficie martillada, para 1 botella
surface martelée, pour 1 bouteille

| | cm | ↑ cm | ltr. | Farbe / Colour |
|-------|-----------|------|------|----------------|
| 36106 | 20,5 x 14 | 17 | 2,1 | copper-look |
| 36107 | 20,5 x 14 | 17 | 2,1 | gunmetal-look |

BOTTLE COOLERS



Flaschenkühler „BRIDGE“

bottle cooler
enfriador de botellas
rafraîchisseur de bouteilles



doppelwandig für beste Isolierung, außen hochglanzpoliert, innen matt poliert

double wall cooler keeps the temp. for a long time, outs. mirror polished, inside matt polished
champañera inox de doble pared, interior pulido mate, exterior pulido brillante
seau inox double paroi, maintient le froid plus longt., intérieur poli mat, extérieur poli brillant

| | Ø cm | ↑ cm | ltr. |
|-------|------|------|------|
| 36077 | 31 | 19 | 10 |



Champagnerkühler

champagne bowl
cubo champañera
seau à champagne



hochglanzpoliert, doppelwandig für beste Isolierung

mirror polished, double wall cooler keeps the temp. for a long time
pulido brillante con champañera inox de doble pared
poli brillant, double paroi, maintient le froid plus longtemps

| | Ø cm | ↑ cm | ltr. |
|-------|---------|------|------|
| 36044 | 44 / 25 | 24 | 10,5 |



Champagnerkühler

champagne bowl
cubo champañera
seau à champagne



außen hochglanzpoliert, innen matt poliert, mit vergoldeten Griffen

outside mirror polished, inside matt polished, with gold plated handles
exterior pulido brillante, interior pulido mate
extérieur brillant, intérieur poli mat

| | Ø cm | ↑ cm | ltr. |
|-------|---------|------|------|
| 36047 | 42 / 27 | 28 | 20 |



Champagnerkühler

champagne bowl
cubo champañera
seau à champagne



hochglanzpoliert

mirror polished
pulido brillante
poli brillant

| | Ø cm | ↑ cm | ltr. |
|-------|-------------|------|------|
| 36045 | 40,5 / 27,5 | 22,5 | 13,5 |



Champagnerkühler

champagne bowl
cubo champañera
seau à champagne



hochglanzpoliert, Rand matt poliert

mirror polished, edge matt polished
pulido brillante, borde pulido mate
poli brillant, bord poli mat

| | Ø cm | ↑ cm | ltr. |
|-------|---------|------|------|
| 36046 | 45 / 21 | 23 | 12 |

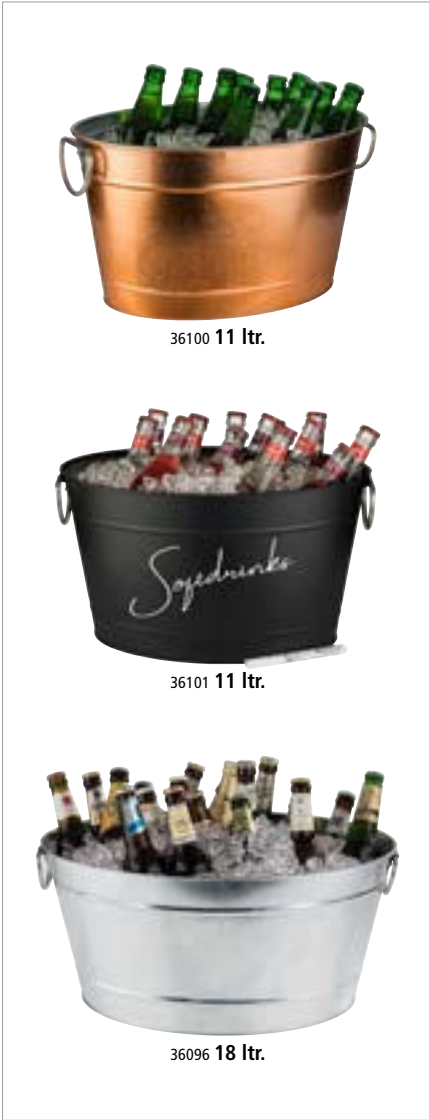

Getränkewanne „TIN“

beverage tub
barreño botellines
bassine à glace

Metall verzinkt, mit Kunststoffeinsatz
galvanised metal, with plastic insert
metal galvanizado, con inserto de plástico
métal galvanisé, avec insert en plastique



| | cm | ↑ cm | ltr. | Farbe / Colour |
|-------|---------|------|------|------------------|
| 36100 | 40 x 28 | 22 | 11 | copper-look |
| 36101 | 40 x 28 | 22 | 11 | black-metal-look |
| 36095 | 40 x 28 | 22 | 11 | metal-look |
| 36096 | 50 x 23 | 23 | 18 | metal-look |



mit Kunststoffeinsatz
with plastic insert
con inserto de plástico
avec insert en plastique



71490

Kreidestift zum Beschriften | chalk marker for writing
S. 304



Wein- / Sektkühler

wine / champagne bowl
cubitera para vino y cava
seau à vin ou champagne

glasklar, für bis zu 6 Flaschen geeignet
transparent, suitable for up to 6 bottles
transparente, para máximo 6 botellas
transparent, maxi 6 bouteilles



| | cm | ↑ cm | ltr. |
|-------|---------|------|------|
| 36057 | 47 x 28 | 23 | 10 |



Wein- / Sektkühler

wine / champagne bowl
cubitera para vino y cava
seau à vin ou champagne

mit seitlichen Griffen, transparent
with lateral handles, transparent
con asas laterales
avec poignées latérales



| | cm | ↑ cm | ltr. |
|-------|-----------|------|------|
| 36087 | 32 x 21,5 | 24,5 | 7 |

BOTTLE COOLERS



36048

Wein- / Sektkühler
 wine / champagne bowl
 cubitera para vino y cava
 seau à vin ou champagne
mit 2 seitlichen Eingriffen
 with 2 handles on the side
 con 2 asas
 avec 2 poignées



| | cm | ↑ cm | ltr. |
|-------|---------|------|------|
| 36048 | 35 x 27 | 25,5 | 6 |
| 36052 | 27 x 20 | 21 | 3 |



36054

Wein- / Sektkühler
 wine / champagne bowl
 cubitera para vino y cava
 seau à vin ou champagne
mit 2 seitlichen Eingriffen
 with 2 handles on the side
 con 2 asas
 avec 2 poignées



| | cm | ↑ cm | ltr. | Farbe / Colour |
|-------|---------|------|------|----------------|
| 36054 | 35 x 27 | 25,5 | 6 | ■ |
| 36053 | 27 x 20 | 21,0 | 3 | ■ |



Wein- / Sektkühler
 wine / champagne bowl
 cubitera para vino y cava
 seau à vin ou champagne
glasklar, für zwei Flaschen
 clear, for two bottles
 transparente, para 2 botellas
 transparent, pour 2 bouteilles



| | cm | ↑ cm | ltr. |
|-------|-------------|------|------|
| 36056 | 30,5 x 21,5 | 26 | 4 |





Flaschenkühler

bottle cooler
enfriador de botella
rafraîchisseur de bouteille

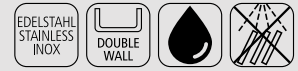

doppelwandig für beste Isolierung, für 0,7 - 1,5 Liter-Flaschen

double wall cooler keeps the temperature for a long time, for 0,7 - 1,5 ltr. bottles
con doble pared para mantener el frio largo tiempo, para botellas de 0,7 - 1,5 ltr.
double paroi pour une meilleure conservation de la température, pour bouteilles de 0,7 à 1,5 l.

| | Ø cm | ↑ cm | Farbe / Colour |
|-------|---------|------|----------------|
| 36125 | 12 / 10 | 20 | copper red |
| 36126 | 12 / 10 | 20 | blue |
| 36127 | 12 / 10 | 20 | black |



Flaschenkühler „COPPER“

bottle cooler
enfriador de botella
rafraîchisseur de bouteille



Hammerschlag-Optik, doppelwandig für beste Isolierung, für 0,7 - 1,5 Liter-Flaschen

double wall cooler keeps the temperature for a long time, hammered look, for 0,7 - 1,5 ltr. bottles
doble pared para mantener el frio largo tiempo, para botellas de 0,7 - 1,5 ltr.
double paroi pour une meilleure conservation de la température, pour bouteilles de 0,7 à 1,5 l.

| | Ø cm | ↑ cm | Farbe / Colour |
|-------|---------|------|----------------|
| 36074 | 12 / 10 | 20 | |



Flaschenkühler

bottle cooler
enfriador de botella
rafraîchisseur de bouteille



matt poliert, doppelwandig für beste Isolierung, für 0,7 - 1,5 Liter-Flaschen

matt polished, double wall cooler keeps the temperature for a long time, for 0,7 - 1,5 ltr. bottles
pulido mate, doble pared para mantener el frio largo tiempo, para botellas de 0,7 - 1,5 ltr.
poli mat, double paroi pour une meilleure conservation de la température, pour bouteilles de 0,7 à 1,5 l.

| | Ø cm | ↑ cm |
|-------|---------|------|
| 36030 | 12 / 10 | 20 |



Flaschenkühler

bottle cooler
enfriador de botella
rafraîchisseur de bouteille



matt poliert, doppelwandig für beste Isolierung, für 0,7 - 1,5 Liter-Flaschen

matt polished, double wall cooler keeps the temperature for a long time, for 0,7 - 1,5 ltr. bottles
pulido mate con doble pared para mantener el frio largo tiempo, para botellas de 0,7 - 1,5 ltr.
poli mat, double paroi pour une meilleure conservation de la température, pour bouteilles de 0,7 à 1,5 l.

| | Ø cm | ↑ cm |
|-------|-----------|------|
| 36038 | 12,5 / 10 | 19 |

BOTTLE COOLERS



Flaschenkühler

bottle cooler
enfriador de botella
rafraîchisseur de bouteille



transparent, doppelwandig für beste Isolierung, mit Chromrand

transparent, double wall cooler keeps the temperature for a long time, with chrome edge
transpar., doble pared mantiene la temperatura por largo tiempo, borde superior cromado
transparent, bord chromé brillant, double paroi pour maintien en température

| | Ø cm | ↑ cm | Farbe / Colour |
|-------|---------|------|----------------|
| 36032 | 12 / 10 | 23 | |
| 36034 | 12 / 10 | 23 | |



Flaschenkühler „PURE“

bottle cooler
enfriador de botella
rafraîchisseur de bouteille



doppelwandig für beste Isolierung, glasklar

double wall cooler keeps the temperature for a long time, clear
doble pared mantiene la temperatura por largo tiempo, transparente
double paroi pour maintien en température, transparent

| | Ø cm | ↑ cm |
|-------|-------------|------|
| 36063 | 13,5 / 10,5 | 23 |
| 36062 | 13,5 / 10,5 | 23 |



Pitcher

pitcher
jarra
pichet



| | Ø cm | ↑ cm | ltr. |
|-------|------|------|------|
| 93105 | 13 | 21 | 1,5 |



einfaches Eingießen
easy pouring

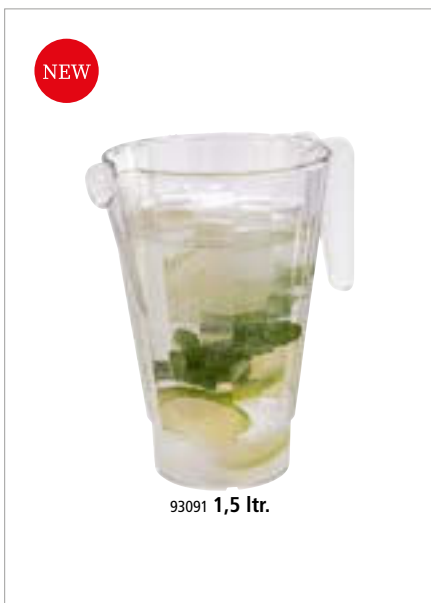

Pitcher

pitcher
jarra
pichet



| | Ø cm | ↑ cm | ltr. |
|-------|------|------|------|
| 93090 | 12,5 | 17,5 | 1,0 |
| 93091 | 13,5 | 20,0 | 1,5 |

passende Deckel / fitting lids / tapa adecuadas / couvercles appropriées

| | cm | ↑ cm | fits to |
|-------|------|------|---------|
| 93092 | 13,0 | 1,5 | 93090 |
| 93093 | 14,0 | 1,5 | 93091 |



Deckel mit Klappe
lid with flap



einfaches Eingießen
easy pouring



stapelbar
stackable



Flaschenkühler „ELEMENT“

bottle cooler
enfriador de botella
rafraîchisseur de bouteille

Beton, geriffelte Oberfläche, möbelschonende Unterseite
concrete, ribbed surface, non-scratching undersurface
hormigón, superficie ranurada, base anti rayaduras
béton, surface rainurée, base revêtement antirayures



| | Ø cm | ↑ cm | Farbe / Colour |
|-------|---------|------|----------------|
| 36122 | 13 / 10 | 19,5 | white |
| 36123 | 13 / 10 | 19,5 | concrete |
| 36124 | 13 / 10 | 19,5 | green |



Oberflächenansicht
structural view



Präsentationsmöglichkeit
presentation example



Flaschenkühler „ELEMENT“

bottle cooler
enfriador de botella
rafraîchisseur de bouteille

Beton, möbelschonende Unterseite
concrete, non-scratching undersurface
hormigón, base anti rayaduras
béton, base revêtement antirayures



| | Ø cm | ↑ cm | Farbe / Colour |
|-------|---------|------|----------------|
| 36104 | 12 / 10 | 19 | rose |
| 36105 | 12 / 10 | 19 | green |



Flaschenkühler „ELEMENT“

bottle cooler
enfriador de botella
rafraîchisseur de bouteille

Beton, möbelschonende Unterseite
concrete, non-scratching undersurface
hormigón, base anti rayaduras
béton, base revêtement antirayures



| | Ø cm | ↑ cm | Farbe / Colour |
|-------|---------|------|----------------|
| 36090 | 12 / 10 | 19 | concrete |
| 36099 | 12 / 10 | 19 | black |

BOTTLE COOLERS

NEW



Flaschenkühler „BIG BOWL“

bottle cooler
enfriador de botella
rafraîchisseur de bouteille



gehämmerte Oberfläche, innen matt poliert, herausnehmbarer Tropfeinsatz

hammered surface, inside matt polished, removable drip tray
superficie martillada, interior pulido mate, bandeja de goteo extraíble
surface martelée, intérieur poli mat, bac de récupération amovible

| | Ø cm | ↑ cm | ltr. |
|-------|------|------|------|
| 36130 | 37 | 23 | 8 |



herausnehmbarer
Tropfeinsatz
removable drip tray



Präsentationsmöglichkeit
presentation example



Kühlmanschette „CHAMPAGNE“

cool collar
funda de frío
housse isotherme



für Sekt- / Champagnerflaschen, einfach im Gefrierfach einfrieren, komplette Flasche wird in 5 Min. auf angenehme Trinktemperatur gekühlt, außen reißfestes Stoffgewebe, innen Kunststoff mit Kühlgel gefüllt, unbegrenzt wiederverwendbar

for bottles of champagne, simply to freeze in the freezer, complete bottles will be cooled down in only 5 minutes, tearproof cloth outside, plastic filled with gel inside, unlimited reusable
para botellas de cava o champán simplemente congelándola en el congelador, la botella entera se enfriará en 5 minutos, funda de plástico muy robusta, rellena con un gel congelante reutilizable ilimitadamente

pour bouteilles de vin ou champagne, la housse est préalablement stockée au congélateur, où elle accumule le froid, ensuite elle refroidit une bouteille en quelques minutes, plastique résistant, contient un liquide congelant, à réutiliser de façon illimitée

| | Ø cm | ↑ cm |
|-------|------|------|
| 36075 | 11 | 18 |



Weinflaschenhalter

winebottle-stand
soporte para botella de vino
porte-bouteille



| | cm | ↑ cm |
|-------|--------|------|
| 30333 | 22 x 6 | 20,5 |

BEVERAGE DISPENSERS



NEW

7 ltr.

10853

Getränkespender „INDUSTRIAL“

beverage dispenser
dispensador de bebidas
distributeur de boissons

Black
is
beautiful

GLAS
GLASS

EDELSTAHL
STAINLESS
INOX

METALL

SILIKON
SILICON

NON
SLIP FEET

Behälter aus Glas, Zapfhahn aus Edelstahl, Fuß und Deckel aus Metall, schwarz, Antirutschmatte aus Silikon

glass container, stainless steel tap, base and lid in black metal, silicone non-slip mat
recipiente de vidrio, grifo de acero inoxidable, base y tapa de metal negro, alfombra antideslizante de silicona

réceptien en verre, robinet en acier inox, pied et couvercle en métal noir, tapis antidérapant en silicone

| | Ø cm | ↑ cm | ltr. | |
|-------|------|------|------|-----------------------------|
| 10450 | 20 | 45 | 7 | inkl. Gestell / incl. stand |



Antirutschmatte aus Silikon
Antirutschmatte aus Silikon



NEW

7 ltr.

Getränkespender „URBAN“

beverage dispenser
dispensador de bebidas
distributeur de boissons

Black
is
beautiful

GLAS
GLASS

EDELSTAHL
STAINLESS
INOX

METALL

SILIKON
SILICON

NON
SLIP FEET

Behälter aus Glas, Zapfhahn aus Edelstahl, Fuß und Deckel aus Metall, schwarz, Antirutschmatte aus Silikon

glass container, stainless steel tap, base and lid in black metal, silicone non-slip mat
recipiente de vidrio, grifo de acero inoxidable, base y tapa de metal negro, alfombra antideslizante de silicona

réceptien en verre, robinet en acier inox, pied et couvercle en métal noir, tapis antidérapant en silicone

| | Ø cm | ↑ cm | ltr. | |
|-------|------|------|------|-----------------------------|
| 10451 | 22 | 45 | 7 | inkl. Gestell / incl. stand |



Antirutschmatte aus Silikon
Antirutschmatte aus Silikon



Eiswasserröhre

ice cube cooling tube
tubo enfriador para cubitos
tube pour glaçons

PP
POLYPROP.



| | Ø cm | ↑ cm | passend für Getränkenspender / fits to drink dispenser |
|-------|------|------|---|
| 10849 | 11 | 24 | 10400, 10403, 10450, 10451, 10855 |

BEVERAGE DISPENSERS



Getränkespender „ELEMENT“

beverage dispenser
dispensador de bebidas
distributeur de boissons



Behälter aus Glas, Zapfhahn aus Edelstahl, Fuß und Deckel aus Beton

glass container, stainless steel tap, stand and lid made of concrete
recipiente de vidrio, grifo de acero inoxidable, soporte y tapa de hormigón
récipient en verre, robinet en acier inox, support et couvercle en béton

| | Ø cm | ↑ cm | ltr. | |
|-------|------|------|------|-----------------------------|
| 10400 | 22 | 45 | 7 | inkl. Gestell / incl. stand |



Getränkespender „OLD FASHIONED“

beverage dispenser
dispensador de bebidas
distributeur de boissons



Behälter aus Glas, Zapfhahn aus Edelstahl, Gestell schwarz

glass container, stainless steel tap, black stand
recipiente de vidrio, grifo de acero inoxidable, soporte negro
récipient en verre, robinet en acier inox, support noir

| | Ø cm | ↑ cm | ltr. | |
|-------|------|------|------|-----------------------------|
| 10409 | 27 | 50,5 | 7 | inkl. Gestell / incl. stand |

Ersatz-Gestell / stand / soporte de recambio / support de remplacement

| | Ø cm | ↑ cm | |
|-------|------|------|--|
| 10410 | 27 | 31,5 | |

Ersatz-Glas / replacement glass / cristal de recambio / vitre de rechange

| | Ø cm | ↑ cm | ltr. |
|-------|------|------|------|
| 10411 | 19 | 36,5 | 7 |

Ersatz-Zapfhahn 10409 / replacement tap for 10409

10718



Getränkespender „ASIA“

beverage dispenser
dispensador de bebidas
distributeur de boissons



Behälter aus Glas, Zapfhahn aus Edelstahl, Fuß und Deckel aus Holz

glass container, stainless steel tap, wooden stand and lid
recipiente de vidrio, grifo de acero inoxidable, soporte y tapa de madera
récipient en verre, robinet en acier inox, support et couvercle en bois

| | Ø cm | ↑ cm | ltr. | |
|-------|------|------|------|-----------------------------|
| 10403 | 24,5 | 45,5 | 7 | inkl. Gestell / incl. stand |

Ersatz-Fuß / base / soporte de recambio / support de remplacement

| | Ø cm | ↑ cm | |
|-------|------|------|--|
| 10404 | 24,5 | 15 | |

Ersatz-Deckel / replacement lid / tapa de recambio / couvercle de rechange

| | Ø cm | ↑ cm | |
|-------|------|------|--|
| 10405 | 14,0 | 5 | |



Tropfenschale, 2-teilig

drip tray, 2 pcs.
aros anti-goteo, set de 2
anneaux coupe-gouttes, set de 2



| | Ø cm | ↑ cm | Farbe / Colour |
|-------|------|------|----------------|
| 10851 | 9,5 | 1,5 | White |
| 10853 | 9,5 | 1,5 | Black |

LINEA



UNZERBRECHLICH | UNBREAKABLE

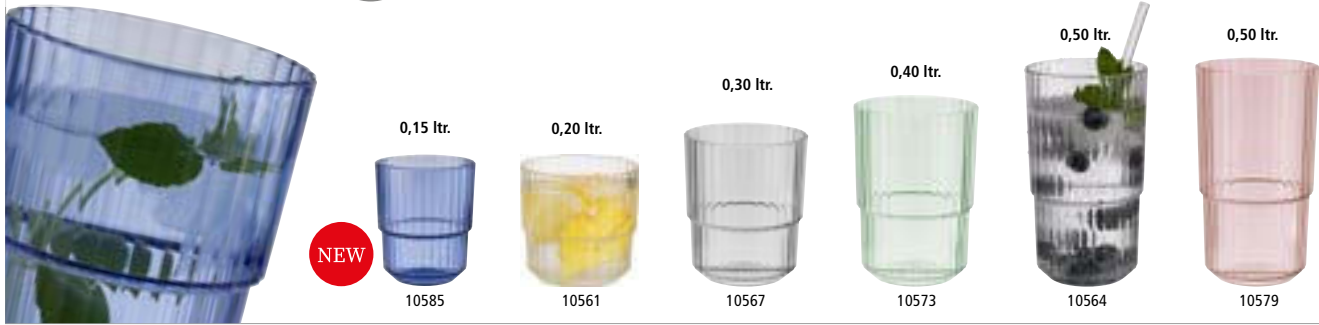

Trinkbecher „LINEA“

drinking cups

vasos

gobelets



Die elegant facettierten Bechergläser LINEA lassen sich vielseitig im Bar-, Club-, Pool-, und Buffetbereich verwenden. Sowohl die transparenten als auch die farbigen Modelle setzen in jedem Ambiente edle Akzente. Dank ihrer perfekten Stapelbarkeit werden sie platzsparend aufbewahrt und transportiert.

The elegantly faceted tumbler glasses LINEA can be used in a variety of ways in the bar, club, pool and buffet areas. Both the transparent and coloured models set elegant accents in any ambience. Thanks to their perfect stackability, they are space-saving to store and transport.

Los vasos LINEA, elegantemente facetados, pueden utilizarse de diversas maneras en el bar, el club, la piscina y el buffet. Tanto los modelos transparentes como los de color ponen elegantes acentos en cualquier ambiente. Gracias a su perfecta apilabilidad, ahorran espacio para su almacenamiento y transporte.

Les verres LINEA élégamment facetés peuvent être utilisés de manière polyvalente dans les bars, les clubs, les piscines et les buffets. Les modèles transparents et colorés apportent une touche de noblesse dans chaque ambiance. Grâce à leur parfaite empilabilité, ils se rangent et se transportent avec un minimum d'encombrement.

| | Ø cm | ↑ cm | litr. | VE | Farbe / Colour | |
|-------|------|------|-------|----|----------------|-------------|
| 10560 | 6,5 | 8,0 | 0,15 | 48 | — | — |
| 10561 | 8,5 | 8,0 | 0,22 | 48 | — | — |
| 10562 | 8,5 | 10,0 | 0,30 | 48 | — | — |
| 10563 | 8,5 | 12,0 | 0,40 | 48 | — | — |
| 10564 | 8,5 | 15,0 | 0,50 | 48 | — | — |
| 10565 | 6,5 | 8,0 | 0,15 | 48 | | french grey |
| 10566 | 8,5 | 8,0 | 0,22 | 48 | | french grey |
| 10567 | 8,5 | 10,0 | 0,30 | 48 | | french grey |
| 10568 | 8,5 | 12,0 | 0,40 | 48 | | french grey |
| 10569 | 8,5 | 15,0 | 0,50 | 48 | | french grey |
| 10570 | 6,5 | 8,0 | 0,15 | 48 | | light green |
| 10571 | 8,5 | 8,0 | 0,22 | 48 | | light green |
| 10572 | 8,5 | 10,0 | 0,30 | 48 | | light green |
| 10573 | 8,5 | 12,0 | 0,40 | 48 | | light green |
| 10574 | 8,5 | 15,0 | 0,50 | 48 | | light green |
| 10575 | 6,5 | 8,0 | 0,15 | 48 | | light pink |
| 10576 | 8,5 | 8,0 | 0,22 | 48 | | light pink |
| 10577 | 8,5 | 10,0 | 0,30 | 48 | | light pink |
| 10578 | 8,5 | 12,0 | 0,40 | 48 | | light pink |
| 10579 | 8,5 | 15,0 | 0,50 | 48 | | light pink |
| 10585 | 6,5 | 8,0 | 0,15 | 48 | | light blue |
| 10586 | 8,5 | 8,0 | 0,22 | 48 | | light blue |
| 10587 | 8,5 | 10,0 | 0,30 | 48 | | light blue |
| 10588 | 8,5 | 12,0 | 0,40 | 48 | | light blue |
| 10589 | 8,5 | 15,0 | 0,50 | 48 | | light blue |



LINEA

5 SIZES



alle Größen
ineinander stapelbar
all sizes stackable

CRYSTAL



UNZERBRECHLICH | UNBREAKABLE

5 SIZES



Trinkbecher „CRYSTAL“
drinking cups
vasos
gobelets



Kristallglas-Optik, vielseitig einsetzbar, robustes, unzerbrechliches Material, ideal in sensiblen Bereichen wie Pool, Spa, Beach und Wellness einzusetzen, BPA-frei
crystal-glass-look, can be used in versatile ways, a solide and unbreakable material, ideal to be used at pool, spa, beach and wellness areas, bpa-free
aspecto vidrio, se pueden utilizar de muchas maneras diferentes, material sólido e irrompible, ideal para el uso en áreas como piscina, spa, playa y bienestar, libre de BPA
ressemble à un verre de cristal, peuvent être utilisés de différentes façons, matériau robuste et incassable, idéal pour une utilisation dans des zones comme la piscine, le spa, la plage et le bien-être, sans BPA

| | Ø cm | ↑ cm | ltr. | VE | Farbe / Colour |
|-------|------|------|------|----|----------------|
| 10500 | 7,0 | 9,5 | 0,15 | 48 | — |
| 10503 | 7,5 | 11,0 | 0,20 | 48 | — |
| 10501 | 8,0 | 12,5 | 0,30 | 48 | — |
| 10504 | 8,5 | 14,0 | 0,40 | 48 | — |
| 10502 | 9,0 | 15,5 | 0,50 | 48 | — |

| | Ø cm | ↑ cm | ltr. | VE | Farbe / Colour |
|-------|------|------|------|----|----------------|
| 10513 | 7,0 | 9,5 | 0,15 | 48 | ■ |
| 10516 | 7,5 | 11,0 | 0,20 | 48 | ■ |
| 10514 | 8,0 | 12,5 | 0,30 | 48 | ■ |
| 10517 | 8,5 | 14,0 | 0,40 | 48 | ■ |
| 10515 | 9,0 | 15,5 | 0,50 | 48 | ■ |



UNZERBRECHLICH
UNBREAKABLE



Made in Germany

Auch die inneren Werte können sich sehen lassen. Der Trinkbecher „CRYSTAL“ wird ressourcenschonend ausschließlich in Deutschland produziert. Das Material ist zu 100% recycelbar.





| | Ø cm | ↑ cm | ltr. | VE | Farbe / Colour |
|-------|------|------|------|----|----------------|
| 10510 | 7,0 | 9,5 | 0,15 | 48 | |
| 10511 | 8,0 | 12,5 | 0,30 | 48 | |
| 10512 | 9,0 | 15,5 | 0,50 | 48 | |
| | Ø cm | ↑ cm | ltr. | VE | Farbe / Colour |
| 10525 | 7,0 | 9,5 | 0,15 | 48 | |
| 10526 | 8,0 | 12,5 | 0,30 | 48 | |
| 10527 | 9,0 | 15,5 | 0,50 | 48 | |
| | Ø cm | ↑ cm | ltr. | VE | Farbe / Colour |
| 10528 | 7,0 | 9,5 | 0,15 | 48 | |
| 10529 | 8,0 | 12,5 | 0,30 | 48 | |
| 10530 | 9,0 | 15,5 | 0,50 | 48 | |
| | Ø cm | ↑ cm | ltr. | VE | Farbe / Colour |
| 10531 | 7,0 | 9,5 | 0,15 | 48 | |
| 10532 | 8,0 | 12,5 | 0,30 | 48 | |
| 10533 | 9,0 | 15,5 | 0,50 | 48 | |
| | Ø cm | ↑ cm | ltr. | VE | Farbe / Colour |
| 10534 | 7,0 | 9,5 | 0,15 | 48 | |
| 10535 | 8,0 | 12,5 | 0,30 | 48 | |
| 10536 | 9,0 | 15,5 | 0,50 | 48 | |

UNZERBRECHLICH
UNBREAKABLE

Farbe grau
colour light grey

stapelbar
stackable

10509

Trinkglas „BEACH“
drinking glass
vaso
verre

vielseitig einsetzbar, robustes, unzerbrechliches Material, BPA-frei
can be used in versatile ways, a solide and unbreakable material, bpa-free
se pueden utilizar de muchas maneras diferentes, material sólido e irrompible, libre de BPA
peuvent être utilisés de différentes façons, matériau robuste et incassable, sans BPA

| | Ø cm | ↑ cm | ltr. | VE | Farbe / Colour |
|-------|------|------|------|----|----------------|
| 10509 | 8,5 | 13,5 | 0,30 | 48 | |
| 10505 | 8,5 | 13,5 | 0,30 | 48 | – |

MOSCOW MULE



Flaschenkühler „MOSCOW MULE“

bottle cooler
enfriador de botellas
rafraîchisseur de bouteilles

Edelstahl-Flaschenkühler, Antik-Kupfer-Look
stainless steel cooler, copper antique look
enfriador de acero inoxidable, cobre estilo antigua
rafraîchisseur en acier inox, cuivre style antique



| | Ø cm | ↑ cm | ltr. | Farbe / Colour |
|-------|------|------|------|--|
| 93330 | 20 | 21 | 5 |  copper-antique-hammered |



Becher „MOSCOW MULE“, 2er-Set

barrel copper mug, 2 pcs.
taza, set de 2
gobelet, set de 2

Edelstahlbecher, Antik-Kupfer-Look
stainless steel cup, copper antique look
taza de acero inoxidable, cobre estilo antiguo
gobelet en acier inox, cuivre style antique

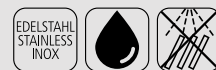

| | Ø cm | ↑ cm | ltr. | Farbe / Colour |
|-------|------|------|------|--|
| 93367 | 9 | 10 | 0,5 |  copper-antique-hammered |



Becher „MOSCOW MULE“

barrel mug
taza
gobelet

Edelstahlbecher, Antik-Edelstahl-Look
stainless steel cup, stainless steel antique look
taza de acero inoxidable, acero estilo antiguo
gobelet en acier inox, acier style antique

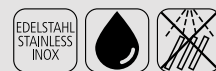

| | Ø cm | ↑ cm | ltr. | Farbe / Colour |
|-------|------|------|------|---|
| 93346 | 9 | 10 | 0,5 |  stainless-antique-hammered |



Becher „MOSCOW MULE“

barrel mug
taza
gobelet

Edelstahlbecher, Antik-Edelstahl-Look

stainless steel cup, stainless antique look
taza de acero inoxidable, acero estilo antiguo
gobelet en acier inox, acier style antique



| | Ø cm | ↑ cm | ltr. | Farbe / Colour | |
|-------|------|------|------|----------------|-------------------|
| 93345 | 9 | 9 | 0,45 | | stainless-antique |



Becher „MOSCOW MULE“

barrel copper mug
taza
gobelet

Edelstahlbecher, Antik-Kupfer-Look

stainless steel cup, copper antique look
taza de acero inoxidable, cobre estilo antiguo
gobelet en acier inox, cuivre style antique



| | Ø cm | ↑ cm | ltr. | Farbe / Colour | |
|-------|------|------|------|----------------|----------------|
| 93322 | 9 | 9 | 0,45 | | copper-antique |



Becher „MOSCOW MULE“

barrel copper mug
taza
gobelet

Edelstahlbecher, Kupfer-Look, hochglanzpoliert

stainless steel cup, copper look, mirror polished
taza de acero inoxidable, estilo cobre, pulido brillante
gobelet en acier inox, aspect cuivre, poli brillant



| | Ø cm | ↑ cm | ltr. | Farbe / Colour | |
|-------|------|------|------|----------------|-------------|
| 93310 | 9 | 9 | 0,45 | | copper-look |



Becher „MOSCOW MULE“

barrel copper mug
taza
gobelet

Edelstahlbecher, Kupfer-Look, hochglanzpoliert

stainless steel cup, copper look, mirror polished
taza de acero inoxidable, estilo cobre, pulido brillante
gobelet en acier inox, aspect cuivre, poli brillant



| | Ø cm | ↑ cm | ltr. | Farbe / Colour | |
|-------|------|------|------|----------------|-----------------|
| 93311 | 9 | 10 | 0,50 | | copper-hammered |



Becher „MOSCOW MULE“

barrel copper mug
taza
gobelet

Edelstahlbecher, Antik-Kupfer-Look

stainless steel cup, copper look
taza de acero inoxidable, cobre estilo antiguo
gobelet en acier inox, cuivre style antique



| | Ø cm | ↑ cm | ltr. | Farbe / Colour | |
|-------|------|------|------|----------------|-------------------------|
| 93323 | 9 | 10 | 0,50 | | copper-antique-hammered |

MOSCOW MULE



Becher „MOSCOW MULE“

barrel mug

taza

gobelet

Edelstahlbecher, Antik-Edelstahl-Look

stainless steel cup, stainless antique look

taza de acero inoxidable, acero estilo antiguo

gobelet en acier inox, acier style antique



| | Ø cm | ↑ cm | litr. | Farbe / Colour | |
|-------|------|------|-------|----------------|-------------------|
| 93333 | 9,5 | 10 | 0,50 | | stainless-antique |



Becher „MOSCOW MULE“

barrel copper mug

taza

gobelet

Edelstahlbecher, Antik-Kupfer-Look

stainless steel cup, copper antique look

taza de acero inoxidable, cobre estilo antiguo

gobelet en acier inox, cuivre style antique



| | Ø cm | ↑ cm | litr. | Farbe / Colour | |
|-------|------|------|-------|----------------|----------------|
| 93331 | 9,5 | 10 | 0,50 | | copper-antique |



Becher „MOSCOW MULE“

barrel copper mug

taza

gobelet

Edelstahlbecher, Kupfer-Look, hochglanzpoliert

stainless steel cup, copper look, mirror polished

taza de acero inoxidable, estilo cobre, pulido brillante

gobelet en acier inox, aspect cuivre, poli brillant



| | Ø cm | ↑ cm | litr. | Farbe / Colour | |
|-------|------|------|-------|----------------|-------------|
| 93332 | 9,5 | 10 | 0,50 | | copper-look |

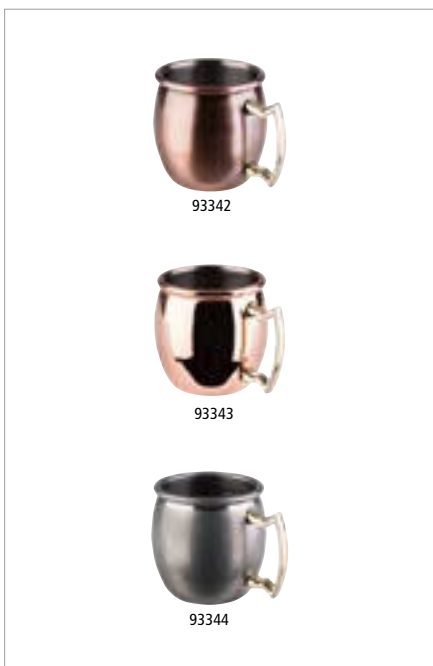

Becher „MINI SHOT“, 4er-Set

barrel mug 4 pcs.

taza, set de 4

gobelet, set de 4



| | Ø cm | ↑ cm | litr. | Farbe / Colour | | pcs. |
|-------|------|------|-------|----------------|-------------------|------|
| 93342 | 4,5 | 4,5 | 0,05 | | copper-antique | 4 |
| 93343 | 4,5 | 4,5 | 0,05 | | copper-look | 4 |
| 93344 | 4,5 | 4,5 | 0,05 | | stainless-antique | 4 |





Becher „COOL“

barrel mug
taza
gobelet



Edelstahlbecher, Kupfer-Look, hochglanzpoliert
stainless steel cup, copper look, mirror polished
taza de acero inoxidable, estilo cobre, pulido brillante
gobelet en acier inox, aspect cuivre, poli brillant

| | Ø cm | ↑ cm | ltr. | Farbe / Colour | |
|-------|------|------|------|----------------|-------------|
| 93371 | 7,5 | 10,5 | 0,35 | | copper-look |



Becher „COOL“

barrel mug
taza
gobelet



Edelstahlbecher, Gunmetal-Look, hochglanzpoliert
stainless steel cup, gunmetal look, mirror polished
taza de acero inoxidable, estilo gunmetal, pulido brillante
gobelet en acier inox, aspect gunmetal, poli brillant

| | Ø cm | ↑ cm | ltr. | Farbe / Colour | |
|-------|------|------|------|----------------|---------------|
| 93372 | 7,5 | 10,5 | 0,35 | | gunmetal-look |



Becher „COOL“

barrel mug
taza
gobelet



Edelstahlbecher, Antik-Edelstahl-Look
stainless steel cup, stainless antique look
taza de acero inoxidable, acero estilo antiguo
gobelet en acier inox, acier style antique

| | Ø cm | ↑ cm | ltr. | Farbe / Colour | |
|-------|------|------|------|----------------|-------------------|
| 93373 | 7,5 | 10,5 | 0,35 | | stainless-antique |

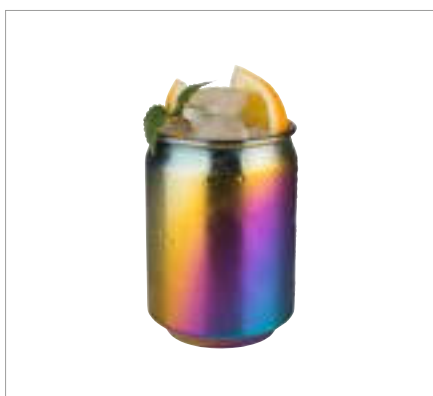

Becher „COOL“

barrel mug
taza
gobelet



Edelstahlbecher, Regenbogen-Look
stainless steel cup, rainbow look
taza de acero inoxidable, estilo arco iris
gobelet en acier inox, look arc-en-ciel

| | Ø cm | ↑ cm | ltr. | Farbe / Colour | |
|-------|------|------|------|----------------|--------------|
| 93374 | 7,5 | 10,5 | 0,35 | | rainbow-look |



Becher „BEER MUG“

barrel mug
taza
gobelet



| | Ø cm | ↑ cm | ltr. | Farbe / Colour | |
|-------|------|------|------|----------------|-------------------|
| 93364 | 8,5 | 13 | 0,50 | | copper-antique |
| 93365 | 8,5 | 13 | 0,50 | | stainless-antique |

93364

93365

PINEAPPLE MUGS



mit Deckel
with lid
ohne Strohalm
without straw

Becher „PINEAPPLE“

barrel mug
taza
gobelet

Glasbecher mit Edelstahl Deckel
glass cup with stainless steel lid
taza de cristal con tapa en acero inoxidable
gobelet en verre avec couvercle en acier inox



| | Ø cm | ↑ cm | litr. |
|-------|------|------|-------|
| 93375 | 8,5 | 17,5 | 0,35 |



mit Deckel
with lid
ohne Strohalm
without straw

Becher „PINEAPPLE“

barrel mug
taza
gobelet

Edelstahlbecher, Kupfer-Look
stainless steel cup, copper look
taza de acero inoxidable, cobre
gobelet en acier inox, cuivre



| | Ø cm | ↑ cm | litr. | Farbe / Colour |
|-------|------|------|-------|---|
| 93334 | 9 | 19 | 0,5 |  copper-look |



mit Deckel
with lid
ohne Strohalm
without straw

Becher „PINEAPPLE“

barrel mug
taza
gobelet

Edelstahlbecher, Gold-Look
stainless steel cup, gold look
taza de acero inoxidable, dorada
gobelet en acier inox, doré



| | Ø cm | ↑ cm | litr. | Farbe / Colour |
|-------|------|------|-------|---|
| 93335 | 9 | 19 | 0,5 |  gold-look |



93399



93400

Gläserchiene

glass rack
rack de copas
rack porte-verres

aus 6 mm Draht, Metall verchromt, Wand- und Deckenmontage möglich
6 mm chrome plated wire, can be mounted under a shelf or on the wall
alambre cromado de 6 mm, puede instalarse bajo una estantería o en la pared
fil chromé de 6 mm, à installer sous une étagère ou contre un mur



| | cm | ↑ cm | for glasses | Farbe / Colour |
|-------|-----------|------|-------------|--|
| 93398 | 29,5 x 32 | 6 | 12 |  chrome |
| 93399 | 29,5 x 32 | 6 | 12 |  black |
| 93400 | 45,0 x 32 | 6 | 20 |  chrome |

JULEP MUGS



Becher „JULEP MUG“ barrel mug taza gobelet

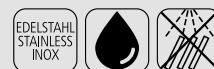

| | Ø cm | ↑ cm | ltr. | Farbe / Colour |
|-------|------|------|------|----------------------------|
| 93336 | 8 | 11,5 | 0,40 | copper-antique-hammered |
| 93337 | 8 | 11,5 | 0,40 | copper-hammered |
| 93338 | 8 | 11,5 | 0,40 | stainless-antique-hammered |



Becher „JULEP MUG“ barrel mug taza gobelet

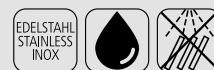

| | Ø cm | ↑ cm | ltr. | Farbe / Colour |
|-------|------|------|------|----------------|
| 93327 | 8,5 | 10 | 0,35 | copper-antique |
| 93328 | 8,5 | 10 | 0,35 | copper-look |
| 93329 | 8,5 | 10 | 0,35 | stainless |



Snackspender snack dispenser dispensador de snacks distributeur de snacks



Behälter aus Glas, Schraubdeckel aus Edelstahl, Öffnung oval 3,5 x 2,5 cm
glass container, stainless steel screw cap, opening oval 3,5 x 2,5 cm
recipiente de cristal, tapón de rosca de acero inoxidable, apertura ovalada 3,5 x 2,5 cm
récipient en verre, couvercle à visser en acier inox, ouverture ovale 3,5 x 2,5 cm

| | Ø cm | ↑ cm | ltr. | Farbe / Colour |
|-------|------|------|------|----------------|
| 40516 | 8,5 | 15,5 | 0,35 | gold-look |
| 40517 | 8,5 | 15,5 | 0,35 | gunmetal-look |



MINI FEUERZANGEN-SETS



**inklusive
50 Zuckerhüte
including
50 sugar cones**

Mini Feuerzangen-Set I

mini fire punch bowl set
mini set para ponche caliente
mini set pour punch



bestehend aus: 6 Mini Feuerzangen / 50 Mini Zuckerhüte

consisting of: 6 mini fire tongs / 50 mini sugar cones
compuesto por: 6 mini pinzas para el fuego / 50 mini conos de azúcar
composé de: 6 mini-pinces à feu / 50 mini-cônes à sucre

| | cm | ↑ cm |
|-------|------------|------|
| 65070 | 14,5 x 3,5 | 1,5 |



**inklusive 50 Zuckerhüte
including 50 sugar cones**

**2 Stk.
2 pcs.**

**2 Stk.
2 pcs.**

Mini Feuerzangen-Set II

mini fire punch bowl set
mini set para ponche caliente
mini set pour punch



bestehend aus:

2 Edelstahlbecher, Kupfer-Look / 2 Mini Feuerzangen / 50 Mini Zuckerhüte

consisting of:
2 stainless steel cups, copper look / 2 mini fire tongs / 50 mini sugar cones
compuesto por:
2 tazas de acero inoxidable, cobre / 2 mini pinzas para el fuego / 50 mini conos de azúcar
composé de:
2 tasses en acier inox, cuivre / 2 mini-pinces à feu / 50 mini-cônes à sucre

| | ∅ cm | ↑ cm | litr. |
|-------|------|------|-------|
| 65071 | 9 | 9 | 0,45 |

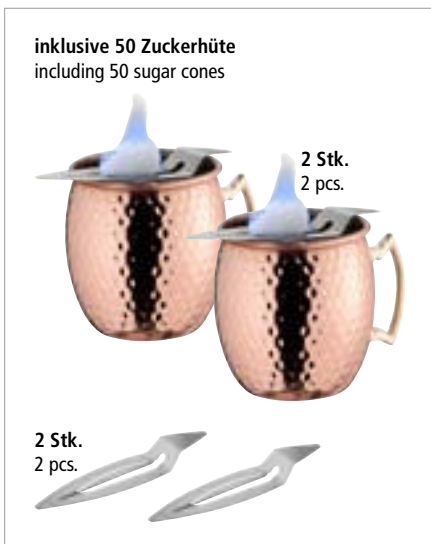

**inklusive 50 Zuckerhüte
including 50 sugar cones**

**2 Stk.
2 pcs.**

**2 Stk.
2 pcs.**

Mini Feuerzangen-Set II

mini fire punch bowl set
mini set para ponche caliente
mini set pour punch



bestehend aus:

2 Edelstahlbecher, Kupfer-Look / 2 Mini Feuerzangen / 50 Mini Zuckerhüte

consisting of:
2 stainless steel cups, copper look / 2 mini fire tongs / 50 mini sugar cones
compuesto por:
2 tazas de acero inoxidable, cobre / 2 mini pinzas para el fuego / 50 mini conos de azúcar
composé de:
2 tasses en acier inox, cuivre / 2 mini-pinces à feu / 50 mini-cônes à sucre

| | ∅ cm | ↑ cm | litr. |
|-------|------|------|-------|
| 65072 | 9 | 10 | 0,5 |

SHAKERS



Shaker „CLASSIC“

shaker
coctelera
shaker



3-teiliges Set: Edelstahlbecher, Siebaufsatz, Deckel, hochglanzpoliert

3 pieces: stainless steel mug, strainer, lid, mirror polished

set de 3: taza de acero inoxidable, colador, tapa, pulido brillante

set de 3: gobelet en acier inox, tamis, couvercle, poli brillant

| | Ø cm | ↑ cm | ltr. |
|-------|------|------|------|
| 36010 | 8,5 | 20 | 0,5 |
| 36011 | 9,0 | 23 | 0,7 |



Shaker „CLASSIC“

shaker
coctelera
shaker





3-teiliges Set: Edelstahlbecher, Siebaufsatz, Deckel, Kupfer-Look, hochglanzpoliert

3 pieces: stainless steel mug, strainer, lid, copper look, mirror polished

set de 3: taza de acero inoxidable, colador, tapa, cobre, pulido brillante

set de 3: gobelet en acier inox, tamis, couvercle, cuivre, poli brillant

| | Ø cm | ↑ cm | ltr. | Farbe / Colour |
|-------|------|------|------|---|
| 93211 | 8,5 | 20 | 0,5 |  copper-look |
| 93212 | 9,0 | 23 | 0,7 |  copper-look |



Shaker „CLASSIC“

shaker
coctelera
shaker



3-teiliges Set: Edelstahlbecher, Siebaufsatz, Deckel

3 pieces: stainless steel mug, strainer, lid

set de 3: taza de acero inoxidable, colador, tapa

set de 3: gobelet en acier inox, tamis, couvercle

| | Ø cm | ↑ cm | ltr. | Farbe / Colour |
|-------|------|------|------|---|
| 93366 | 9,0 | 23 | 0,7 |  stainless-antique |
| 93326 | 9,0 | 23 | 0,7 |  copper-antique |

SHAKERS



Parisian Shaker

shaker
coctelera
shaker

2-teiliges Set, Edelstahlbecher, mattiert

2 pieces, stainless steel cup, matt polished
set de 2, taza de acero, pulido mate
set de 2, gobelet en acier, poli mat



| | Ø cm | ↑ cm | ltr. |
|-------|------|------|------|
| 93179 | 9,5 | 24 | 0,7 |



Boston Shaker

boston shaker
coctelera boston
shaker boston

2-teiliges Set: Becher, 700 ml + Glas, 400 ml

2 pcs.: beaker, 700 ml + glass, 400 ml
set de 2: vaso coctelero, 700 ml+ vaso vidrio 400 ml
set de 2: bol mélangeur, 700 ml + bol en verre 400 ml



| | Ø cm | ↑ cm | ltr. | Farbe / Colour |
|-------|------|------|-----------|-------------------|
| 93140 | 9 | 30 | 0,7 / 0,4 | stainless-steel |
| 93350 | 9 | 30 | 0,7 / 0,4 | stainless-antique |
| 93325 | 9 | 30 | 0,7 / 0,4 | copper-antique |
| 93201 | 9 | 30 | 0,7 / 0,4 | copper-look |

Ersatzglas / spare glass / vaso de recambio / verre de rechange

| | Ø cm | ↑ cm | ltr. |
|-------|------|------|------|
| 93138 | 8,5 | 14,5 | 0,4 |



Boston Shaker

boston shaker
coctelera boston
shaker boston

2-teiliges Set: Becher, 700 ml, gummiert, rutschfest + Glas, 400 ml

2 pcs.: beaker, 700 ml, rubberized, anti-slip + glass, 400 ml
set de 2: vaso coctelero con goma exterior 700 ml + vaso de vidrio 400 ml
set de 2: bol mélangeur inox extérieur plastifié couleur 700 ml + bol en verre 400 ml



| | Ø cm | ↑ cm | ltr. | Farbe / Colour |
|-------|------|------|------|----------------|
| 93139 | 9 | 30 | 0,7 | |

Ersatzglas / spare glass / vaso de recambio / verre de rechange

| | Ø cm | ↑ cm | ltr. |
|-------|------|------|------|
| 93138 | 8,5 | 14,5 | 0,4 |

JIGGERS



Barmaß
jigger
medidor jigger
mesure double jigger



schnelles und genaues Abmessen von Spirituosen, mit Füllstrich
quick and exact measuring of spirits, with fill line
medida rápida y exacta de licores, con línea de llenado
mesure exact et rapide des spiritueux, avec ligne de remplissage

| | Ø cm | ↑ cm | ltr. | Farbe / Colour | |
|-------|------|------|-------|----------------|--------------------------|
| 93351 | 4,5 | 9 | 2 / 4 | | stainless-steel-polished |
| 93354 | 4,5 | 9 | 2 / 4 | | stainless-antique |



Barmaß
jigger
medidor jigger
mesure double jigger



schnelles und genaues Abmessen von Spirituosen, mit Füllstrich
quick and exact measuring of spirits, with fill line
medida rápida y exacta de licores, con línea de llenado
mesure exact et rapide des spiritueux, avec ligne de remplissage

| | Ø cm | ↑ cm | ltr. | Farbe / Colour | |
|-------|------|------|-------|----------------|----------------|
| 93353 | 4,5 | 9 | 2 / 4 | | copper-look |
| 93352 | 4,5 | 9 | 2 / 4 | | copper-antique |



Barmaß
jigger
medidor jigger
mesure double jigger



schnelles und genaues Abmessen von Spirituosen, mit Füllstrich
quick and exact measuring of spirits, with fill line
medida rápida y exacta de licores, con línea de llenado
mesure exact et rapide des spiritueux, avec ligne de remplissage

| | Ø cm | ↑ cm | ltr. | Farbe / Colour | |
|-------|------|------|---------------------|----------------|--------------------------|
| 93164 | 4,5 | 9 | 1,5 / 2,5 / 3,5 / 5 | | stainless-steel-polished |
| 93355 | 4,0 | 11 | 1,5 / 2,5 / 3,5 / 5 | | stainless-antique |



Barmaß
jigger
medidor jigger
mesure double jigger



schnelles und genaues Abmessen von Spirituosen, mit Füllstrich
quick and exact measuring of spirits, with fill line
medida rápida y exacta de licores, con línea de llenado
mesure exact et rapide des spiritueux, avec ligne de remplissage

| | Ø cm | ↑ cm | ltr. | Farbe / Colour | |
|-------|------|------|---------------------|----------------|----------------|
| 93165 | 4,5 | 9 | 1,5 / 2,5 / 3,5 / 5 | | copper-look |
| 93324 | 4,0 | 11 | 1,5 / 2,5 / 3,5 / 5 | | copper-antique |

JIGGERS



Barmaß
jigger
medidor jigger
mesure double jigger



hochglanzpoliert, schnelles und genaues Abmessen von Spirituosen, mit Füllstrich
mirror polished, quick and exact measuring of spirits, with fill line
pulido brillante, medida rápida y exacta de licores, con línea de llenado
poli miroir, mesure exact et rapide des spiritueux, avec ligne de remplissage

| | ∅ cm | ↑ cm | cl. |
|-------|------|------|-------------------------|
| 93356 | 5 | 9 | 1 / 1,5 / 2 / 3 / 4 / 6 |



Barmaß
jigger
medidor jigger
mesure double jigger



hochglanzpoliert, schnelles und genaues Abmessen von Spirituosen, mit Füllstrich
mirror polished, quick and exact measuring of spirits, with fill line
pulido brillante, medida rápida y exacta de licores, con línea de llenado
poli miroir, mesure exact et rapide des spiritueux, avec ligne de remplissage

| | ∅ cm | ↑ cm | cl. |
|-------|------|------|-------|
| 93357 | 3,5 | 7,5 | 3 / 5 |



Barmaß
jigger
medidor jigger
mesure double jigger



hochglanzpoliert, schnelles und genaues Abmessen von Spirituosen, mit Füllstrich
mirror polished, quick and exact measuring of spirits, with fill line
pulido brillante, medida rápida y exacta de licores, con línea de llenado
poli miroir, mesure exact et rapide des spiritueux, avec ligne de remplissage

| | ∅ cm | ↑ cm | cl. |
|-------|-----------|------|---------|
| 93121 | 4,0 / 3,5 | 8,5 | 2 / 4 |
| 93112 | 4,5 / 4,0 | 8,5 | 2,5 / 5 |



Barmaß
jigger
medidor jigger
mesure double jigger



hochglanzpoliert, schnelles und genaues Abmessen von Spirituosen, mit Füllstrich
mirror polished, quick and exact measuring of spirits, with fill line
pulido brillante, medida rápida y exacta de licores, con línea de llenado
poli miroir, mesure exact et rapide des spiritueux, avec ligne de remplissage

| | ∅ cm | ↑ cm | cl. |
|-------|-----------|------|-------|
| 93120 | 4,5 / 3,5 | 7,0 | 2 / 4 |



Barmaß
jigger
medidor jigger
mesure double jigger



hochglanzpoliert, schnelles und genaues Abmessen von Spirituosen, mit Füllstrich
mirror polished, quick and exact measuring of spirits, with fill line
pulido brillante, medida rápida y exacta de licores, con línea de llenado
poli miroir, mesure exact et rapide des spiritueux, avec ligne de remplissage

| | ∅ cm | ↑ cm | cl. |
|-------|-------|------|-------|
| 93116 | 6 / 5 | 6 | 2 / 4 |

BAR SPOONS

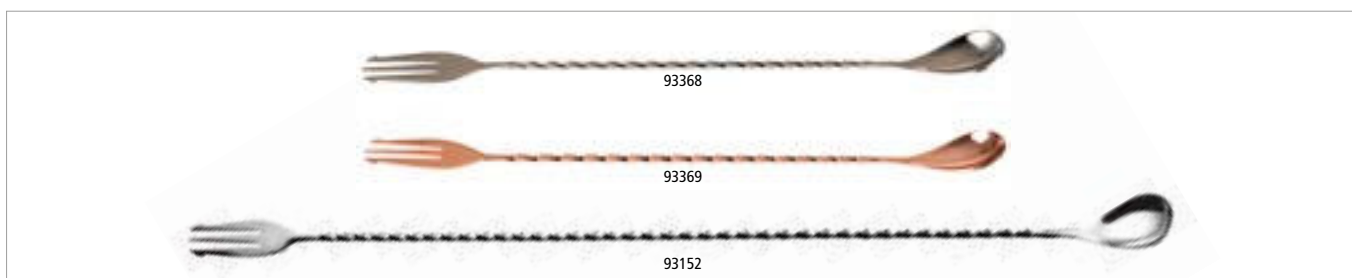

Barlöffel / -gabel
bar spoon
cucharilla de cóctel trident
cuillère de bar trident



| | → cm | Farbe / Colour | |
|-------|------|----------------|-----------------|
| 93368 | 30 | | stainless steel |
| 93369 | 30 | | copper-look |
| 93152 | 50 | | stainless steel |

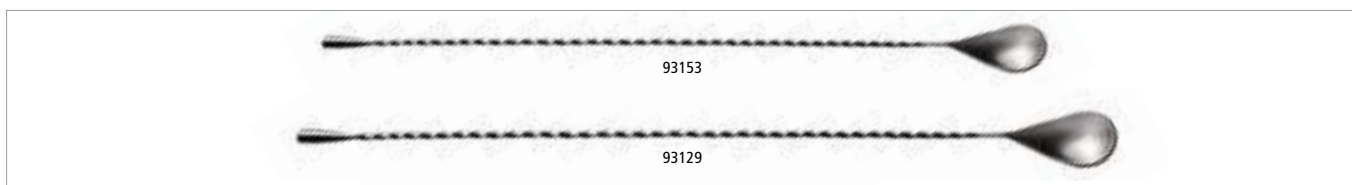

Barlöffel
bar spoon
cucharilla de cóctel
cuillère à cocktail



| | → cm | Farbe / Colour | |
|-------|------|----------------|-----------------|
| 93153 | 40 | | stainless steel |
| 93129 | 44 | | stainless steel |

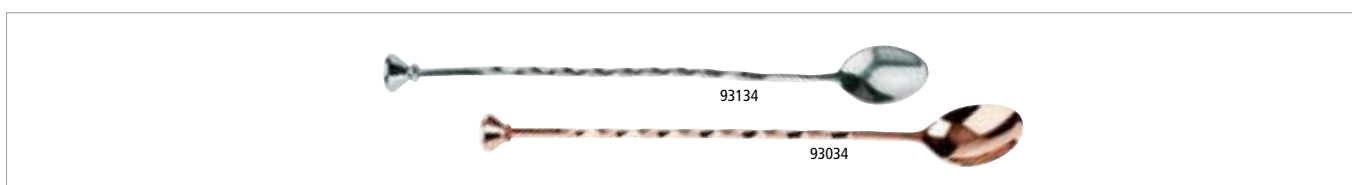

Barlöffel
bar spoon
cucharilla de cóctel
cuillère à cocktail



| | → cm | Farbe / Colour | |
|-------|------|----------------|-----------------|
| 93134 | 27 | | stainless steel |
| 93034 | 27 | | copper-look |



BAR STRAINERS



Barsieb

bar strainer
colador de cóctel
tamis cocktail



Spiralfeder hält Eiswürfel beim Abseihen zurück, Feder kann zur Reinigung entnommen werden, passend für alle Gläser und Shaker

coil spring keeps ice cubes in shaker, spring can be taken off for cleaning, suitable for all glasses and shakers

con muelle para mantener los cubitos en la coctelera, el muelle se desmonta para limpiar, se adapta a todos los tipos de vasos y cocteleras

avec ressort pour garder les glaçons dans le shaker, ressort démontable pour lavage, s'adapte à tous types de verres mélangeurs et shakers

| | Ø cm | Griff / handle cm | Farbe / Colour | |
|-------|------|-------------------|----------------|-------------------|
| 93347 | 9 | 9 | | copper-antique |
| 93348 | 9 | 9 | | copper-look |
| 93349 | 9 | 9 | | stainless-antique |
| 93312 | 9 | 9 | | stainless steel |



Einhandgebrauch
single-handed use



Barsieb

bar strainer
colador de cóctel
tamis cocktail



hochglanzpoliert, Spiralfeder hält Eiswürfel beim Abseihen zurück, Feder kann zur Reinigung entnommen werden, passend für alle Gläser und Shaker

mirror polished, coil spring keeps ice cubes in shaker, spring can be taken off for cleaning, suitable for all glasses and shakers

pulido brillante, con muelle para mantener los cubitos en la coctelera, el muelle se desmonta para limpiar, se adapta a todos los tipos de vasos y cocteleras

poli brillant, avec ressort pour garder les glaçons dans le shaker, ressort démontable pour lavage, s'adapte à tous types de verres mélangeurs et shakers

| | Ø cm | Griff / handle cm |
|-------|------|-------------------|
| 93300 | 8 | 6 |



Julep Barsieb „PRO“

julep strainer
colador de cóctel
tamis cocktail



hochglanzpoliert, Einhandgebrauch

mirror polished, single-handed use

pulido brillante, uso con una sola mano

poli brillant, utilisation d'une seule main



| | Ø cm | Griff / handle cm |
|-------|------|-------------------|
| 93313 | 7,5 | 9 |



Barsieb
bar strainer
colador de cóctel
tamis cocktail



| | Ø cm | ↑ cm | Griff / handle cm |
|-------|------|------|-------------------|
| 93318 | 8,5 | 5 | 11,5 |



Schneidebrett „BAR“
cutting board
table de corte
planche à découper



HDPE, mit Safrinne, mit Antirutschfüßchen
HDPE, with juice groove and non-slip feet
HDPE, con ranura para líquidos y pies antideslizantes
HDPE, avec rigole et pieds antidérapants

| | cm | ↑ cm |
|-------|---------|------|
| 93306 | 30 x 20 | 2 |
| 93307 | 50 x 30 | 2 |



Cocktailmesser „ORANGE“
bar knife
cuchillo para cóctel
couteau cocktail



mit 2 Zinken zum Aufspießen von Zitrusseiben
with 2 prongs to pick up slices of lemon
con 2 dientes para pinchar las rodajas de limón, etc.
avec 2 dents pour les rondelles de citron et autres décorations

| | → cm |
|-------|------|
| 88846 | 21 |



Dekoriermesser „ORANGE“
decorating knife „cannelé“
cuchillo acanalador
couteau canneléur



gezahnte Klinge aus geschärftem Edelstahl
serrated sharpened blade, stainless steel
hoja de sierra afilada, acero inoxidable
lame inox microdentée

| | → cm |
|-------|------|
| 88843 | 19 |



Zutatenbehälter
condiment holder
dispensador de especias
boîte à fruits et ingrédients



500 ml Inhalt pro Fach, 6 Fächer, inklusive Deckel (gefrostet) zur Lagerung
6 chambers á 500 ml, including lid for storing
6 compartimentos de 500 ml., incluye tapa para el almacenaje
6 compartiments de 500 ml chacun, avec couvercle pour le stockage

| | cm | ↑ cm |
|-------|---------|------|
| 93171 | 50 x 16 | 10 |

Ersatzbehälter / replacement container / recipiente de recambio / récipient de remplacement

| | cm | ↑ cm | fits to |
|-------|----------|------|---------|
| 93176 | 14 x 7,5 | 7,5 | 93171 |



MUDDLERS



Stößel
muddler
mortero
pilon muddler



mit griffigem Ende, zum Auspressen von Früchten und Zerstoßen von Würfelzucker
with handy end, to press fruits or pound lump sugar
con un acabado en relieve para exprimir frutas y machacar azucarillos
avec relief grillagé pour presser les fruits ou le sucre en morceaux

| | Ø cm | → cm | | Farbe / Colour | € |
|-------|------|------|-------------------|----------------|---|
| 93358 | 3,5 | 20,5 | stainless steel | | |
| 93360 | 3,5 | 20,5 | copper-look | | |
| 93361 | 3,5 | 20,5 | stainless-antique | | |
| 93362 | 3,5 | 20,5 | copper-antique | | |



Stößel
muddler
mortero
pilon muddler



grober Stößel, zum Auspressen von Früchten und Zerstoßen von Würfelzucker
coarse notched, to press fruits or pound lump sugar
mortero grueso con muescas para exprimir frutas y machacar azucarillos
muddler grand format avec bout relief étoile pour presser les fruits ou le sucre en morceaux

| | Ø cm | → cm | Farbe / Colour |
|-------|------|------|----------------|
| 93181 | 2,5 | 21 | |
| 93182 | 4 | 24 | |



Stößel
muddler
mortero
pilon muddler



aus Buchenholz, mit griffigem Ende, zum Auspressen von Früchten und Zerstoßen von Würfelzucker
beech wood, with handy end, to press fruits or pound lump sugar
madera de haya, acabado relieve para prensar frutas o azucar
bois de hêtre, avec relief grillagé pour presser les fruits ou le sucre en morceaux

| | Ø cm | → cm | Farbe / Colour |
|-------|------|------|----------------|
| 93180 | 2,5 | 21 | |

LIME AND LEMON SQUEEZERS



Limetten- / Zitronenpresse

lime- / lemon squeezer
exprimidor de limón / lima
presse citron



2 Pressringe für Zitrone und Limette
2 squeezing rings for lemon and lime
2 anillos exprimidores para limón y lima
2 anneaux à presser pour le citron et le lime

| | cm | ↑ cm |
|-------|--------|------|
| 93214 | 21 x 7 | 5 |



Limettenpresse

lime squeezer
prensa de limón
presse citron



| | cm | ↑ cm |
|-------|--------|------|
| 93189 | 21 x 7 | 5 |



Zitruspresse

citrus squeezer
exprimidor cítricos
presse-citron



hochglanzpoliert, 2-teilig
mirror polished, 2 pcs.
pulido brillante, 2 piezas
poli brillant, 2 pièces

| | Ø cm | ↑ cm | ltr. |
|-------|---------|------|------|
| 71431 | 12 / 17 | 10,5 | 0,35 |

ICE CUBE MAKERS



Eiswürfel | ice cube
4 x 4 x 4 cm

Eiswürfelform mit Deckel, 2er Set

ice cube maker with lid, 2 pcs.
molde para cubitos de hielo con tapa, set de 2
moule à glaçons avec couvercle, set de 2

2 Eiswürfelformen für je 9 Stk. Eiswürfel

2 ice cube moulds for 9 ice cubes each

2 moldes de cubitos de hielo para 9 cubitos cada uno

2 moules à glaçons pour 9 glaçons chacun



| | cm | ↑ cm | ice cubes | pcs. |
|-------|-------------|------|-----------|------|
| 36102 | 15,5 x 15,5 | 5,5 | 4 x 4 x 4 | 2 |



Die Eiswürfel lassen sich leicht auslösen
the ice cubes are easy to release

Eiswürfel | ice cube
4 x 2,5 x 3 cm

Eiswürfelform mit Deckel, 2er Set

ice cube maker with lid, 2 pcs.
molde para cubitos de hielo con tapa, set de 2
moule à glaçons avec couvercle, set de 2

2 Eiswürfelformen für je 21 Stk. Eiswürfel

2 ice cube moulds for 21 ice cubes each

2 moldes de cubitos de hielo para 21 cubitos cada uno

2 moules à glaçons pour 21 glaçons chacun



| | cm | ↑ cm | ice cubes | pcs. |
|-------|---------|------|-------------|------|
| 36103 | 25 x 15 | 4 | 4 x 2,5 x 3 | 2 |



Eiskugel | ice ball
Ø 6 cm

Eiskugelformer

ice ball former
molde de cubitos de hielo esféricos
moule à glaçons en boules

2-teilig, 3 Kugeln à 100 ml, einfach mit Wasser füllen und gefrieren lassen

3 bowls à 100 ml, simply fill with water and allow to freeze

3 bolas de 100 ml, simplemente llenar con agua y dejar congelar

3 boules à 100 ml, simplement remplir avec de l'eau et mettre à congeler



| | cm | ↑ cm | ice balls |
|-------|------------|------|-----------|
| 12990 | 23,5 x 8,5 | 6,5 | Ø 6 |



Eisbox
icebox
cubitera
seau à glaçons



Innenbehälter dient als Tropfeinsatz, hält die Eiswürfel bis zu 5 Stunden in ihrer Form
inner container serves as drainer, ice bucket keeps the ice cubes in shape for up to 5 hours
contenedor interior sirve como inserto de goteo, mantiene los cubitos de hielo en forma hasta 5 horas
récipient intérieur sert d'égouttoir, maintient les glaçons dans leur forme jusqu'à 5 heures

| | cm | ↑ cm | litr. | |
|-------|---------|------|-------|--------------------|
| 93220 | 27 x 27 | 15 | 5 | max. 300 ice cubes |



Eisbox
icebox
cubitera
seau à glaçons



Innenbehälter dient als Tropfeinsatz, hält die Eiswürfel bis zu 5 Stunden in ihrer Form
inner container serves as drainer, ice bucket keeps the ice cubes in shape for up to 5 hours
contenedor interior sirve como inserto de goteo, mantiene los cubitos de hielo en forma hasta 5 horas
récipient intérieur sert d'égouttoir, maintient les glaçons dans leur forme jusqu'à 5 heures

| | cm | ↑ cm | litr. | |
|-------|---------|------|-------|--------------------|
| 93200 | 20 x 20 | 17 | 3,4 | max. 150 ice cubes |



Eisbox
icebox
cubitera
seau à glaçons



Innenbehälter dient als Tropfeinsatz, hält bis zu 5 Stunden die Eiswürfel in ihrer Form
inner container serves as drainer, keeps the ice cubes in shape for up to 5 hours
contenedor interior sirve como inserto de goteo, mantiene los cubitos de hielo en forma hasta 5 horas
récipient intérieur sert d'égouttoir, maintient les glaçons dans leur forme jusqu'à 5 heures

| | Ø cm | ↑ cm | litr. | |
|-------|------|------|-------|--------------------|
| 36033 | 18,5 | 20 | 3 | max. 150 ice cubes |
| 36037 | 27 | 20 | 6 | max. 300 ice cubes |



Eiseimer-Set mit Eiszange
ice bucket set with tong
cubitera clásica con pinza
seau à glaçons classique avec pince



mit Abtropfgitter, isolierter Kunststoffeinsatz, Zange lässt sich im Deckel verstauen, für max. 50 Eiswürfel, hält die Eiswürfel bis zu 5 Stunden in ihrer Form
with drainer, insulated plastic insert, tongs can be stored in the lid, for max. 50 ice cubes, keeps the ice cubes in shape for up to 5 hours
con escurridor, inserto de plástico aislado, la pinza se puede guardar en la tapa, para un máximo de 50 cubitos de hielo, mantiene los cubitos de hielo en forma hasta 5 horas
avec égouttoir, insert en plastique isolé, la pince peut être rangée dans le couvercle, pour max. 50 glaçons, maintient les glaçons dans leur forme jusqu'à 5 heures

| | Ø cm | ↑ cm | litr. |
|-------|------|------|-------|
| 36015 | 14 | 22 | 1,3 |

ICE BUCKETS



Eiseimer-Set mit Eiszange

ice bucket set with tong
cubitera clásica con pinza
seau à glaçons classique avec pince

für max. 45 Eiswürfel, hält die Eiswürfel bis zu 5 Stunden in ihrer Form

max. 45 ice cubes, keeps the ice cubes in shape for up to 5 hours

para un máximo de 45 cubitos de hielo, mantiene los cubitos de hielo en forma hasta 5 horas
pour max. 45 glaçons, maintient les glaçons dans leur forme jusqu'à 5 heures



| | Ø cm | ↑ cm | ltr. |
|-------|------|------|------|
| 36013 | 12 | 14 | 1 |



3-teiliges Set
3 pcs.



Eiszerkleinerer

Ice crusher
picadora de hielo
broyeur à glaçons

glasklar, mit Edelstahl-Messer

clear, stainless steel cutters
cuchillas de acero inoxidable
couteaux inox



| | cm | ↑ cm |
|-------|---------|------|
| 36017 | 12 x 12 | 24 |



Eisschaufel

ice scoop
pala de hielo
pelle à glaçons



| | cm | → cm | ltr. |
|-------|--------|------|------|
| 93192 | 10 x 6 | 29 | 0,7 |



Eisschaufel

ice scoop
pala de hielo
pelle à glaçons

gelocht, ideal zum Befüllen von schlanken Gläsern

perforated, ideal to fill narrow glasses

perforada, ideal para llenar vasos estrechos

perforée, idéale pour verser les glaçons dans des verres étroits



| | Ø cm | → cm |
|-------|------|------|
| 93191 | 5 | 19,5 |



Eiszange

ice tongs
pinzas para hielo
pince de la glace

hochglanzpoliert, mit Befestigungsclip

mirror polished, with fastening clip
pulido brillante, con clip de fijación
poli brillant, avec clip de fixation



| | → cm | Farbe / Colour |
|-------|------|-----------------|
| 75853 | 20 | stainless steel |
| 75854 | 20 | copper-look |
| 75855 | 20 | gunmetal-look |



Zange kann an einer Schale befestigt werden
tongs can be attached to a bowl



Pinzettenzange

fine tong / tweezer
pinza de emplatat
pince à dresser

hochglanzpoliert, geriffelte Grifffläche, schwere Qualität

mirror polished, ribbed handle, heavy gauge
pulido brillante, mango cómodo ranurado, alta calidad
poli brillant, manche rainuré antiglisse, qualité extra



| | → cm |
|-------|------|
| 75820 | 16 |
| 75821 | 30 |



Eiszange

ice cube tong
pinza para cubitos de hielo
pince à glaçons

hochglanzpoliert, fugenlos

mirror polished, seamless
pulido brillante, de una sola pieza
poli brillant, d'une seule pièce



| | cm | → cm |
|-------|-------|------|
| 75805 | 5 x 2 | 17,5 |



Eiszange

ice tong
pinza para cubitos de hielo
pince à glaçons

matt poliert, mit griffigem Ende, ideal für Eiswürfel und Obstscheiben

matt polished, with handy end, ideal for ice cubes and fruit slices
pulido mate, forma ergonómica ideal para cubitos de hielo y láminas de fruta
poli mat, forme ergonomique idéale pour glaçons et fruits tranchés



| | cm | → cm |
|-------|---------|------|
| 93190 | 2 x 1,5 | 20 |



STRAWS



Trinkhalme 11er Set

straws, 11 pcs. set
pajas, set de 11 pz.
pailles, set de 11 pc.



11-teiliges Set: 10 Trinkhalme aus Edelstahl + Reinigungsbürste

11 pcs. set: 10 drinking straws made of stainless steel + cleaning brush
set de 11: 10 pajas de acero inoxidable + cepillo de limpieza
set de 11: 10 pailles en acier inox + brosse de nettoyage

| | Ø mm | → cm | Farbe / Colour | |
|-------|------|------|----------------|---------------|
| 93391 | 8 | 15,0 | | copper-look |
| 93392 | 8 | 15,0 | | gunmetal-look |
| 93393 | 8 | 15,0 | | rainbow-look |
| 93380 | 6 | 21,5 | | copper-look |
| 93381 | 6 | 21,5 | | gunmetal-look |
| 93382 | 6 | 21,5 | | rainbow-look |
| 93383 | 8 | 21,5 | | copper-look |
| 93384 | 8 | 21,5 | | gunmetal-look |
| 93385 | 8 | 21,5 | | rainbow-look |

Ersatzbürste / replacement brush / cepillo de recambio / brosse de rechange

| | Ø mm | → cm |
|-------|------|------|
| 93395 | 8 | 15 |
| 93386 | 8 | 20 |



Trinkhalme 7er Set

straws, 7 pcs. set
pajas, set de 7 pz.
pailles, set de 7 pc.



| | Ø mm | → cm | pcs. |
|-------|------|------|------|
| 93394 | 10 | 15 | 7 |
| 93390 | 10 | 21 | 7 |





Barmatte

drip mat
tapete escurridor
tapis de bar

aus weichem Kunststoff, zum Abtropfen von Gläsern etc.
soft plastic, to store and drain glasses
plástico blando para escurrir vasos
plastique souple, pour l'égouttage des verres



| | cm | ↑ cm | Farbe / Colour | |
|-------|---------|------|----------------|-----------------|
| 93168 | 60 x 8 | 1 | | mit Vertiefung |
| 93166 | 30 x 15 | 1 | | ohne Vertiefung |
| 93173 | 52 x 8 | 1 | | ohne Vertiefung |
| 93169 | 60 x 8 | 1 | | ohne Vertiefung |
| 93167 | 45 x 31 | 1 | | ohne Vertiefung |

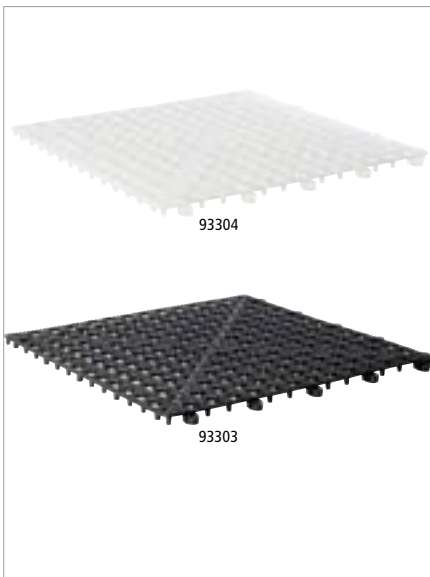

Abtropfmatte

drip mat
esterilla escurridora
tapis égouttoir

erweiterbar durch Klick-Verbindung
expandable
las placas de fijan con clips
avec clips de fixation



| | cm | ↑ cm | Farbe / Colour |
|-------|---------|------|----------------|
| 93304 | 33 x 33 | 1,5 | |
| 93303 | 33 x 33 | 1,5 | |



Glasumrand

glass rimmer
ribeteador de vasos
bordeur à verres „rimmer“

Schwamm für Limettensaft, 2 Fächer für Zucker und Salz
with sponge for lime juice, 2 cases for sugar and salt
con esponja para zumo de lima, 2 compartimentos para azucar y sal
avec éponge et 2 compartiments pour sucre et sel



| | cm |
|-------|----------|
| 93175 | 20 x 7,5 |



Bar Caddy

bar caddy
organizador de bar
organisateur „bar caddy“

Ordnungshilfe für Trinkhalm, Rührer, Servietten, Streichhölzer, etc.
to organize straws, stirrers, napkins, matches, etc.
para organizar pajitas, cucharillas, servilletas, cerillas, etc.
pour bien organiser les pailles, agitateurs, cuillers, serviettes et autres accessoires



| | cm | ↑ cm |
|-------|---------|------|
| 93174 | 24 x 15 | 11 |

CONFERENCE BOTTLE COOLERS



00621

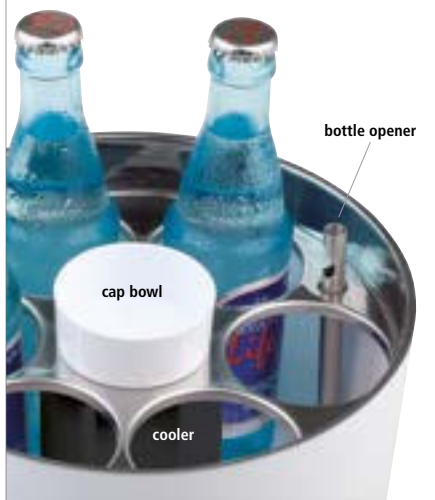

Flaschenkühler „CONFERENCE“

conference bottle cooler
enfriador múltiple
rafraîchisseur



inkl. Kühllakku, Flaschenöffner, Kronkorkenschale,
mit 6 Öffnungen Ø 6,7 cm für 0,25 - 0,5 Liter-Flaschen

incl. bottle cooler, bottle opener, small cap bowl,
with 6 holes Ø 6,7 cm for 0,25 to 0,5 liter bottle

con acumulador de frío, abridor, recuperador de chapas,
6 plazas Ø 6,7 cm, para botellas de 25 a 50 cl

avec accumulateur de froid, décapsuleur, bol récupérateur
de capsules, 6 places Ø 6,7 cm, pour bouteilles de 25 à 50 cl

| | Ø cm | ↑ cm | Farbe / Colour |
|-------|------|------|----------------|
| 00620 | 23 | 15 | ■ |
| 00621 | 23 | 15 | ■ |

Kühllakku / cooler / acumulador de frío / accumulateur de froid

| | Ø cm | ↑ cm | Farbe / Colour |
|-------|------|------|----------------|
| 00615 | 7,5 | 11,5 | ■ |

Kronkorkenschale / cap bowl / cuenco para chapas / bol récupérateur de capsules

| | Ø cm | ↑ cm | Farbe / Colour |
|-------|------|------|----------------|
| 00618 | 6,5 | 3 | ■ |
| 00619 | 6,5 | 3 | ■ |

Flaschenöffner / bottle opener / abridor / décapsuleur

| | Ø cm | → cm |
|-------|------|------|
| 00617 | 1 | 13,5 |



Staubkappen, 2er Set

dust & fly cap, 2 pcs.
tapón antipolvo
bouchon anti-poussières et anti-insectes

schützt vor Staub und Insekten

protects for dust and insects

para proteger de la suciedad e insectos

pour protéger de la poussière et des insectes



| | Ø cm | ↑ cm | Farbe / Colour | pcs. |
|-------|------|------|----------------|------|
| 93161 | 4 | 8 | ■ | 2 |



Schlüsselschnur, 2er Set

key cord, 2 pcs.
llavero enrollable
porte-clés avec câble à enroulement

Befestigung mit Klammer am Gürtel, starke Rückzugfeder
to fix at waistbelt, strong pull-back spring

se fija en el cinturón, cable retrocede automáticamente

à fixer à la ceinture, enroulage automatique



| | Ø cm | ↑ cm |
|-------|------|------|
| 93170 | 4 | 2 |



Dosier- & Vorratsflasche

pouring container
botella „store & pour“
bouteille „store & pour“



4-teilig: Behälter + Flaschenhals + Schraubdeckel + Ausgießer Ø 11 mm mit Luftzufuhr für gezieltes Ausgießen, zum Dosieren und Aufbewahren

4 pcs. set: for storage, mixing and serving drinks, nozzle Ø 11 mm

set de 4 piezas: para almacenar y servir mezclas y bebidas, agujero de Ø 11 mm

se compose de 4 pièces: idéal pour servir et pour conserver les boissons, embout Ø 11 mm

| | Ø cm | ↑ cm | ltr. | Farbe / Colour |
|-------|------|------|------|----------------|
| 93144 | 9 | 33 | 0,85 | |
| 93145 | 9 | 33 | 0,85 | |
| 93146 | 9 | 33 | 0,85 | |
| 93147 | 9 | 33 | 0,85 | |
| 93148 | 9 | 33 | 0,85 | |



abnehmbarer Boden dient als Deckel
removable bottom serves as a lid



93308 200 ml



93309

Spritzflasche inklusive Ausgießer

squeeze bottle with nozzle
botella exprimible con dosificador
flacon pulvérisateur avec bec verseur

ideal für Bitter-Liköre, Essig, Öl

perfect for bitter liqueur, vinegar, oil

perfecto para amargo licor, vinagre, aceite

pour amaro liqueure, vinaigre, huile



| | cm | ↑ cm | ltr. |
|-------|-------|------|------|
| 93308 | 6 x 5 | 20 | 0,2 |

Ausgießer passend für Spritzflasche / nozzle suitable for squeeze bottle / dosificador apto para botella exprimible / bec verseur approprié pour flacon pulvérisateur

| | Ø cm | ↑ cm |
|-------|------|------|
| 93309 | 2,5 | 5,5 |



93141 0,5 ltr.

93101 1,0 ltr.

Rührglas mit Lippe

mixing glass with lip
vaso mezclador vertedor con pico
verre mélangeur avec bec verseur

schwere Qualität

heavy quality

alta calidad

qualité renforcée



| | Ø cm | ↑ cm | ltr. |
|-------|------|------|------|
| 93141 | 9 | 16 | 0,5 |
| 93101 | 11,5 | 19 | 1,0 |

POURERS



Permanent-Ausgießer, 6er Set
 free flow pourer, 6 pcs.
 vertedor contínuos set 6 piezas
 set de 6 bouchons verseurs continus



| | ↑ cm | pcs. |
|-------|------|------|
| 93110 | 11 | 6 |



Permanent-Ausgießer, 6er Set
 free flow pourer, 6 pcs.
 vertedor contínuos set 6 piezas
 set de 6 bouchons verseurs continus



| | ↑ cm | pcs. |
|-------|------|------|
| 93114 | 8 | 6 |



Sekt-Verschluss, 2er Set
 stopper, 2 pcs.
 set de 2 taponos
 set de 2 bouchons



matt poliert, innen Gummi Arabicum
 matt polished, inside rubber arabicum, with inscription
 pulido mate, interior goma arábica con inscripción
 poli maté, intérieur gomme arabique

| | Ø cm | ↑ cm | pcs. |
|-------|------|------|------|
| 93160 | 4 | 5,5 | 2 |



Permanent-Ausgießer, 6er Set
 free flow pourer, 6 pcs.
 vertedor contínuos set 6 piezas
 set de 6 bouchons verseurs continus



à 2 Stück: blau, rot, gelb
 2 pcs of each colour: blue, red, yellow
 2 piezas de cada color: azul, rojo, amarillo
 2 par couleur: bleu, rouge, jaune

| | Ø cm | ↑ cm | pcs. |
|-------|------|------|------|
| 93111 | 3 | 7,5 | 6 |



Reinigungsbürste für Ausgießer
 pourer cleaning brush
 cepillo de limpieza para picos vertedores
 brosse lave-bouchons doseurs



| | → cm |
|-------|------|
| 93102 | 16,5 |



Kellnermesser „PROFI“

waiter's corkscrew
sacacorchos de camarero
tire-bouchons



leichtgängige Teflon-Spirale, mehrstufige Klapphebelfunktion, am Fuß angebrachtes Messer
easy moving teflon coil, 2-stage opening system, knife at the bottom end
mecha de teflón, sistema de apertura en 2 golpes, con cuchillo en la parte superior
mèche téflon, ouverture en 2 étapes, couteau dans la partie supérieure

→ cm

93302 11,5



Kellnermesser

waiter's corkscrew
sacacorchos de camarero
tire-bouchons



leichtgängige Teflon-Spirale, mehrstufige Klapphebelfunktion, am Kopf angebrachtes Messer
easy moving teflon coil, 2-stage opening system, knife at the top end
mecha de teflón, sistema de apertura en 2 golpes, con cuchilla en la parte superior
mèche téflon, ouverture en 2 étapes, couteau dans la partie supérieure

→ cm

93301 12



Kellner-Flaschenöffner

waiter's barblade
abridor camarero
décapsuleur



matt poliert / matt polished / pulido mate / poli mat

→ cm

93122 18

00617 13,5



Kellner-Flaschenöffner

waiter's barblade
abridor camarero
décapsuleur



mit Gummierung
with rubber coating
con revestimiento de goma
avec revêtement en caoutchouc

→ cm

93125 11



Kronkorkenöffner

bottle cap opener
abridor de chapas de pared
décapsuleur mural



für die Wandmontage, aus massivem Metall, inklusive 2 Schrauben
for wall fastening, massive metal, including 2 screws
para fijación en la pared, metal macizo, incluye 2 tornillos
massif, à fixer au mur, y compris 2 vis

cm ↑ cm

93124 7 x 8 3

BARISTA

Life begins after coffee



10334

Milch-/Universalkanne

non stick jug
jarra antiadherente
pichet antiadhésif

PTFE-antihafbeschichtet, perfekt für die Herstellung von Milchschaum

PTFE coated, for baristas frothing hot milk
revestimiento PTFE, ideal para espume de leche
revêtement PTFE, idéal pour faire mousser le lait



| | Ø cm | ↑ cm | ltr. |
|-------|------|------|------|
| 10334 | 8,0 | 10,0 | 0,35 |
| 10335 | 9,0 | 11,5 | 0,60 |
| 10336 | 10,5 | 13,0 | 0,80 |



10329

Milch- / Universalkanne

milk / water jug
jarra leche / agua
pichet à eau / lait

außen hochglanzpoliert, innen matt poliert, mit Maßskalierung innen

outside mirror polished, inside matt polished, with dimension scaling inside
exterior pulido brillante, interior pulido mate, con escala de dimensiones en el interior
extérieur brillant, intérieur mat poli maté, avec une échelle de dimension à l'intérieur



| | Ø cm | ↑ cm | ltr. |
|-------|------|------|------|
| 10328 | 8,0 | 10,0 | 0,35 |
| 10329 | 9,0 | 11,5 | 0,6 |
| 10330 | 10,5 | 13,0 | 0,8 |
| 10331 | 12,0 | 16,5 | 1,3 |
| 10332 | 13,5 | 18,0 | 2,0 |



10350

Milch- / Universalkanne „VEGAN“

milk / water jug
jarra leche / agua
pichet à eau / lait

außen hochglanzpoliert, innen matt poliert, mit Gravur „VEGAN“

outside mirror polished, inside matt polished, with engraving „VEGAN“
exterior pulido brillante, interior pulido mate, con grabado „VEGAN“
extérieur brillant, intérieur mat poli maté, avec gravure „VEGAN“



| | Ø cm | ↑ cm | ltr. |
|-------|------|------|------|
| 10350 | 9,0 | 11,5 | 0,6 |
| 10351 | 10,5 | 13,0 | 0,8 |

NEW



10361

Milch- / Universalkanne

milk / water jug
jarra leche / agua
pichet à eau / lait



außen weiß pulverbeschichtet, innen matt poliert

outside white powder coated, inside matt polished
exterior recubrimiento de polvo blanco, interior pulido mate
extérieur revêtement en poudre blanc, intérieur mat poli maté

| | Ø cm | ↑ cm | ltr. |
|-------|------|------|------|
| 10360 | 8,0 | 10,0 | 0,35 |
| 10361 | 9,0 | 10,0 | 0,50 |
| 10362 | 9,5 | 11,5 | 0,75 |



mit Gravur am Boden
with engraving on the bottom



10323

Kaffeekanne

coffee pot
cafetera
pichet à café



hochglanzpoliert, mit Klappdeckel

mirror polished, with hinged cover
pulido brillante, tapa con bisagra
poli brillant, couvercle à charnière

| | Ø cm | ↑ cm | ltr. |
|-------|------|------|------|
| 10323 | 8,0 | 11,5 | 0,35 |
| 10322 | 9,0 | 14,0 | 0,6 |
| 10325 | 10,5 | 15,5 | 0,9 |
| 10326 | 12,0 | 18,5 | 1,5 |
| 10327 | 13,5 | 20,0 | 2,0 |

NEW



verstellbar durch Verschieben des Clips
adjustable by sliding the clip

Thermometer für Milchkännchen

thermometer for milk / water jug
termómetro para jarra leche / agua
thermomètre pour pichet à eau / lait

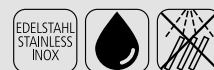

mit Clip, höhenverstellbar, Temperaturbereich 20°C bis 100°C, Graduierung 2°C

with clip, height adjustable, temperature range 20°C to 100°C, graduation 2°C
con clip, regulable en altura, rango de temperatura de 20°C a 100°C, graduación 2°C
avec clip, réglable en hauteur, plage de température 20°C à 100°C, graduation 2°C

| | Ø cm | ↑ cm |
|-------|------|------|
| 10355 | 4,0 | 13,5 |



Anwendungsbeispiel
application example



Mini-Milchkanne „SNACKHOLDER“ 4er Set

mini milk can, 4 pcs.
lechera en formato mini, set de 4
pot à lait mini, set de 4



| | Ø cm | ↑ cm | ltr. | pcs. |
|-------|------|------|------|------|
| 40640 | 4,5 | 5 | 0,08 | 4 |



Milchkännchen / Sahnegießer, 4er Set

milk/cream jugs, 4 pcs.
pack de 4 jarritas para leche o crema
pack de 4 crémiers

hochglanzpoliert, für Kaffeesahne, mit Griff, Inhalt à 25 ml
mirror polished, for coffee-cream, with handle, capacity à 25 ml
pulido brillante, para crema de café, con asa, capacidad 25 ml
poli brillant, avec anse, 25 ml



| | Ø cm | ↑ cm | ltr. | pcs. |
|-------|------|------|-------|------|
| 10321 | 3,5 | 3,5 | 0,025 | 4 |



Milchkännchen / Sahnegießer

milk / cream jug
jarra de leche/ crema
pichet à eau ou lait



| | Ø cm | ↑ cm | ltr. |
|-------|------|------|------|
| 10318 | 4 | 4 | 0,05 |
| 10319 | 5 | 5 | 0,09 |
| 10320 | 6 | 6 | 0,15 |



Allzweckgießer

pourer
bote vertedor universal
pot verseur universel
für Honig, Kaffeesahne, etc., Schraubdeckel
for honey, cream, etc., screw cap
para miel, crema, etc., tapa de rosca
pour le miel, le lait, la crème, etc., bouchon à vis



| | Ø cm | ↑ cm | ltr. |
|-------|------|------|------|
| 00765 | 8,5 | 13,5 | 0,3 |

Ersatzglasbehälter / spare glas-container / contenedor de repuesto / récipient verre de rechange

00768



Allzweckgießer

pourer
dosificador
doseur
für Honig, Kaffeesahne, etc., Schraubdeckel
for honey, cream, etc., screw cap
para miel, crema, etc., tapa de rosca
pour le miel, le lait, la crème, etc., bouchon à vis



| | Ø cm | ↑ cm | ltr. |
|-------|------|------|------|
| 40488 | 8 | 12,5 | 0,25 |



Milch- und Zucker-Set

bowl
cuenco
bol

5-teilig: Tablett, Milchkanne, Zuckerdose mit Deckel, Löffel, Akazienholz, Edelstahl PTFE beschichtet, schwarz

5 pcs.: tray, milk jug, sugar bowl with lid, spoon, acacia wood, stainless inox PTFE coated, black

set de 5: bandeja, jarra de leche, azucarero con tapa, cuchara, madera de acacia, acero inoxidable revestimiento PTFE, negro

set de 5: plateau, pichet à lait, sucrier avec couvercle, cuillère, bois d'acacia, acier inox revêtement PTFE, noir



| | cm | ↑ cm |
|-------|---------|------|
| 00634 | 19 x 10 | 10,5 |



Zuckerkugel

sugar pot
azucarero
sucrier

hochglanzpoliert, mit Rolldeckel

mirror polished, rolltop cover
pulido brillante, tapa abatible
poli brillant, couvercle abattant



| | Ø cm | ↑ cm |
|-------|------|------|
| 00033 | 13,5 | 15 |



170 ml

Zuckerdosierer

sugar dispenser
azucarero
sucrier

matt poliert, Deckel mit Bajonettverschluss / matt polished, lid with bayonet catch / pulido mate, tapa con cierre de bayoneta / poli mat, couvercle avec fermeture à baïonnette



| | Ø cm | ↑ cm | ltr. |
|-------|------|------|------|
| 10316 | 5 | 15 | 0,17 |



40509 200 ml

40508 200 ml

Zuckerdosierer

sugar dispenser
azucarero
sucrier

Schraubdeckel, mit Dosierrohr / screw cap, with dosing tube / tapa de rosca y tubo dosificador / bouchon à vis et tube doseur



| | Ø cm | ↑ cm | ltr. |
|-------|------|------|------|
| 40509 | 6 | 14,5 | 0,2 |
| 40508 | 6,5 | 14,5 | 0,2 |



300 ml

Zuckerdosierer

sugar dispenser
azucarero
sucrier

Schraubdeckel, mit Dosierrohr / screw cap, with dosing tube / tapa de rosca y tubo dosificador / bouchon à vis et tube doseur



| | Ø cm | ↑ cm | ltr. |
|-------|------|------|------|
| 00766 | 8,5 | 15 | 0,3 |

Ersatzglasbehälter / spare glass-container / contenedor de repuesto / récipient verre de rechange

00768



320 ml

Zuckerdosierer

sugar dispenser
azucarero
sucrier

Schraubdeckel, mit Dosierrohr / screw cap, with dosing tube / tapa de rosca y tubo dosificador / bouchon à vis et tube doseur



| | Ø cm | ↑ cm | ltr. |
|-------|------|------|------|
| 40506 | 7,5 | 17,0 | 0,32 |



250 ml

Zuckerdosierer

sugar dispenser
azucarero
sucrier



Schraubdeckel, mit Dosierrohr / screw cap, with dosing tube / tapa de rosca y tubo dosificador / bouchon à vis et tube doseur

| | Ø cm | ↑ cm | ltr. |
|-------|------|------|------|
| 40486 | 8 | 15 | 0,25 |



40490 150 ml

40494 250 ml

Zuckerdosierer

sugar dispenser
azucarero
sucrier



Schraubdeckel, mit Dosierrohr / screw cap, with dosing tube / tapa de rosca y tubo dosificador / bouchon à vis et tube doseur

| | Ø cm | ↑ cm | ltr. |
|-------|------|------|------|
| 40490 | 8,5 | 12 | 0,15 |
| 40494 | 8,0 | 15 | 0,25 |

Ersatzglasbehälter / spare glass-container / contenedor de repuesto / récipient verre de rechange

| | fits to |
|-------|---------|
| 40498 | 40490 |
| 40499 | 40494 |



40487
320 ml

40510
350 ml

Zuckerdosierer

sugar dispenser
azucarero
sucrier



Schraubdeckel mit Klappe, mit Dosierklappe / screw cap, with dosing flap / tapa de rosca, con tubo dosificador / bouchon à vis, avec couvercle doseur

| | Ø cm | ↑ cm | ltr. |
|-------|------|------|------|
| 40487 | 7,5 | 13,5 | 0,32 |

Zuckerdosierer „OLD FASHIONED“ / sugar dispenser / azucarero / sucrier

| | Ø cm | ↑ cm | ltr. |
|-------|------|------|------|
| 40510 | 7,5 | 14 | 0,35 |



Teebrühsieb

snap mesh tea ball
infusor de té, pinza con malla
boule à thé avec pince



matt poliert, mit feinem Sieb, aufklappbar / matt polished, with fine mesh, hinged / pulido mate, con malla fina, con bisagra / poli mat, maille fine, avec charnière

| | Ø cm | → cm |
|-------|------|------|
| 74750 | 4,5 | 15,5 |



Zitronenschnitzpresse

lemon slice squeezer
pinza exprimelimon
pinza presse citron



hochglanzpoliert, zum Auspressen von Zitronenscheiben / mirror polished, to press lemon slices / pulido brillante, para rodajas de limón / poli brillant, pour citrons en rondelle

| | cm |
|-------|-------|
| 71430 | 8 x 7 |

TEAPOTS



NEW



10995 0,8 ltr.



10996 0,8 ltr.

mit Teesieb / with tea strainer

Teekanne „ASIA“

teapot
tetera
théière

aus Gusseisen, innen emailliert, abnehmbarer Deckel, mit Teesieb aus Edelstahl

made of cast iron, enamelled inside, removable lid, with tea strainer made of stainless steel

hierro fundido, interior esmaltado, tapa extraíble, con colador de té de acero inoxidable

en fonte, émaillé à l'intérieur, couvercle amovible, avec une passoire à thé en acier inox

| | cm | ↑ cm | ltr. | Farbe / Colour |
|-------|---------|------|------|----------------|
| 10995 | 17 x 14 | 17 | 0,8 | ■ |
| 10996 | 17 x 14 | 17 | 0,8 | ■ |



10991 0,8 ltr.



10992 0,8 ltr.

mit Teesieb / with tea strainer

Teekanne „ASIA“

teapot
tetera
théière

aus Gusseisen, innen emailliert, mit abnehmbarem Deckel,

inklusive Teesieb aus Edelstahl, ideal für 2-3 Tassen. Geeignet für alle Herdarten.

made of cast iron, enamelled inside, with removable lid, incl. tea strainer made of stainless steel, ideal for 2-3 cups. Suitable for all types of stoves.

hierro fundido, interior esmaltado, con tapa extraíble, incl. colador de té de acero inoxidable, ideal para 2-3 tazas. Apta para todas las placas de cocina.

en fonte, émaillé à l'intérieur, avec couvercle amovible, y compris une passoire à thé en acier inox, idéale pour 2-3 tasses. Convient à tous les types de feux (gaz, vitro ou induction).

| | cm | ↑ cm | ltr. | Farbe / Colour |
|-------|-----------|------|------|----------------|
| 10991 | 19,5 x 18 | 15 | 0,8 | ■ |
| 10992 | 19,5 x 18 | 15 | 0,8 | ■ |



0,3 ltr.

ohne Teesieb / without tea strainer

Teekanne „ASIA“

teapot
tetera
théière

aus Gusseisen, innen emailliert, mit abnehmbarem Deckel, ohne Teesieb aus Edelstahl

made of cast iron, enamelled inside, with removable lid, without tea strainer made of stainless steel

hierro fundido, interior esmaltado, con tapa extraíble, sin colador de té de acero inoxidable

en fonte, émaillé à l'intérieur, avec couvercle amovible, sans une passoire à thé en acier inox

| | cm | ↑ cm | ltr. | Farbe / Colour |
|-------|-----------|------|------|----------------|
| 10990 | 12,5 x 11 | 12,5 | 0,3 | ■ |



30130



30131



30132



30133



30140



30141



30142

Tablett „VINTAGE“

tray
bandeja
plateau

Antik-Edelstahl-Look
stainless steel antique look
acero estilo antiguo
acier style antique



| | cm | ↑ cm | |
|-------|-------------|------|-------------|
| 30130 | 26,0 x 13,5 | 1,5 | rectangular |
| 30131 | 34,0 x 18,0 | 1,5 | rectangular |
| 30132 | 38,0 x 26,5 | 1,5 | rectangular |
| 30133 | 25,5 x 16,0 | 3,0 | rectangular |
| 30140 | 20,0 x 14,5 | 1,0 | oval |
| 30141 | 26,5 x 19,5 | 1,0 | oval |
| 30142 | 29,0 x 22,0 | 1,0 | oval |

passende Schälchen / fitting bowls / cuencos adecuados / bols appropriés



| | Ø cm | ↑ cm | litr. |
|-------|------|------|-------|
| 40655 | 7,5 | 5,5 | 0,17 |
| 40656 | 7,5 | 10 | 0,35 |



Wachspapier „SNACKHOLDER“ / greaseproof paper squares
papel alimenticio para cucurucho / papier alimentaire pour cornet



| | cm | pcs. | |
|-------|---------|------|----------------|
| 40670 | 42 x 25 | 500 | Motiv: Zeitung |



30130



30132



30141

Servierbeispiel
presentation example

**Serviertablett „KAFFEEHAUS“**

tray
bandeja
plateau

matt poliert, Rand eingerollt

matt polished, rolled edge

acabado pulido efecto pulido mate, borde redondeado

effet poli mat, bord rond



| | cm | ↑ cm |
|-------|-----------|------|
| 30119 | 23 x 23 | 1,5 |
| 30118 | 21,5 x 13 | 1,5 |

**Serviertablett „KAFFEEHAUS“**

tray
bandeja
plateau

matt poliert, oval, Rand eingerollt

matt polished, oval, rolled edge

pulido mate, oval, borde redondeado

poli mat, ovale, bord rond

für Zucker und Sahne / for sugar and cream / para azúcar y crema / pour le sucre et la crème

| | cm | ↑ cm |
|-------|-------------|------|
| 30111 | 20,0 x 14,5 | 0,5 |

für eine Tasse / for one cup / para una taza / pour une tasse

| | cm | ↑ cm |
|-------|-------------|------|
| 30112 | 26,5 x 19,5 | 0,5 |

für zwei Tassen / for two cups / para dos tazas / pour deux tasses

| | cm | ↑ cm |
|-------|-------------|------|
| 30113 | 29,0 x 22,0 | 0,5 |

**Serviertablett „KAFFEEHAUS“**

tray
bandeja
plateau

hochglanzpoliert, oval, Rand eingerollt

mirror polished, oval, rolled edge

pulido brillante, ovalado, borde redondeado

poli brillant, ovale, bord rond

für Zucker und Sahne / for sugar and cream / para azúcar y crema / pour le sucre et la crème

| | cm | ↑ cm |
|-------|-------------|------|
| 30115 | 20,0 x 14,5 | 0,5 |

für eine Tasse / for one cup / para una taza / pour une tasse

| | cm | ↑ cm |
|-------|-------------|------|
| 30116 | 26,5 x 19,5 | 0,5 |

für zwei Tassen / for two cups / para dos tazas / pour deux tasses

| | cm | ↑ cm |
|-------|-------------|------|
| 30117 | 29,0 x 22,0 | 0,5 |



TRAYS



Serviertablett „KAFFEEHAUS“

tray
bandeja
plateau

matt poliert, oval
matt polished, oval
pulido mate, oval
poli mat, ovale



| | cm | ↑ cm |
|-------|-------------|------|
| 30126 | 25,5 x 19,5 | 2 |



30148

30149

Serviertablett „KAFFEEHAUS“

tray
bandeja
plateau

hochglanzpoliert, stabiler Rand eingerollt
mirror polished, stable edge rolled in
pulido brillante, borde estable enrollado
poli brillant, bord stable enroulé



| | cm | ↑ cm |
|-------|-----------|------|
| 30148 | Ø 27 | 1,5 |
| 30149 | 30 x 15,5 | 1,5 |

passende Hauben / cover / campana / cloche



| | cm | ↑ cm | suitable for |
|-------|---------|------|--------------|
| 11055 | Ø 23 | 12,0 | 30148 |
| 11056 | 26 x 12 | 10,0 | 30149 |



Servierbeispiel
presentation example



Serviertablett „KAFFEEHAUS“

tray
bandeja
plateau

Innenfläche ziseliert, Rand eingerollt
chiselled inner surface, rolled edge
superficie interior cincelada, borde redondeado
surface intérieure ciselée bord rond



| | cm | VE / unit |
|-------|---------|-----------|
| 30114 | 30 x 22 | 48 |



84251

Serviertablett „KAFFEEHAUS“

tray
bandeja
plateau



| | cm | ↑ cm | Farbe / Colour |
|-------|-------------|------|----------------|
| 84251 | 26,0 x 20,0 | 1,5 | ■ |
| 84253 | 28,5 x 21,5 | 1,5 | ■ |

**Tablett „BISTRO“**

tray
bandeja
plateau

rutschfest, mit 2 Griffmulden und Stapelrand

non-slip, two open handles, stackable edge

anti-deslizante, 2 asas

antidérapant, 2 anses



| | Ø cm | ↑ cm | Farbe / Colour |
|-------|------|------|----------------|
| 84045 | 35,5 | 4,5 | ■ |



00510

Serviertablett „HAPPY HOUR“

tray
bandeja
plateau

rutschfeste Oberfläche

non-slip surface

superficie anti-deslizante

surface antidérapante



| | Ø cm | ↑ cm | Farbe / Colour |
|-------|------|------|----------------|
| 00510 | 32 | 1,5 | ■ |
| 00511 | 38 | 1,5 | ■ |
| 00515 | 43 | 1,5 | ■ |



00500

Bierglasträger „NON-SLIP“

beer rack

bandeja para cerveza

porte verre à bière

rutschfeste Oberfläche

non-slip surface

superficie anti-deslizante

surface antidérapante



| | Ø cm | ↑ cm | Farbe / Colour |
|-------|------|------|----------------|
| 00500 | 36 | 3,5 | ■ |

| | cm | ↑ cm | Farbe / Colour |
|-------|---------|------|----------------|
| 00506 | 28 x 20 | 1,5 | ■ |



00548

Tablett „GASTRO“

tray
bandeja
plateau

rutschfeste Oberfläche

non-slip surface

superficie anti-deslizante

surface antidérapante



| | Ø cm | ↑ cm | Farbe / Colour |
|-------|------|------|----------------|
| 00547 | 27,5 | 2 | ■ |
| 00548 | 35,5 | 2 | ■ |
| 00549 | 40,5 | 2 | ■ |

TRAYS



Tablett

tray
bandeja
plateau

rutschfest, Mahagonifurnier

non-slip, woodform, mahogany
antideslizante
antidérapant



| | Ø cm | ↑ cm |
|-------|------|------|
| 00528 | 31,0 | 3,5 |
| 00529 | 35,5 | 3,5 |



Tablett

tray
bandeja
plateau

rutschfest, Holzdekor-Laminat

non-slip, coated wood
antideslizante
antidérapant



| | cm | ↑ cm |
|-------|---------|------|
| 00521 | 26 x 20 | 1 |
| 00522 | 29 x 21 | 1 |



Tablett

tray
bandeja
plateau

rutschfest, Holzdekor-Laminat

non-slip, coated wood
antideslizante
antidérapant



| | cm | ↑ cm |
|-------|-------------|------|
| 00524 | 43,5 x 31,5 | 1,5 |
| 00525 | 52,0 x 39,0 | 1,5 |
| 00526 | 60,5 x 42,5 | 1,5 |



Serviertablett „NON-SLIP“

tray non-slip
bandeja antideslizante
plateau antiglisse

rutschfeste Oberfläche

non-slip surface
superficie antideslizante
surface antidérapante



| | cm | ↑ cm | GN | Farbe / Colour |
|-------|-----------|------|-----|----------------|
| 00502 | 53 x 32,5 | 1,5 | 1/1 | ■ |
| 00508 | 46 x 36,0 | 2 | | ■ |

FAST FOOD TRAYS



00535



00536



00537



00538



00534



00539

Fast Food-Tablett
 snack tray
 bandeja autoservicio y snacks
 plateau self-service et snacks



| | cm | ↑ cm | GN | Farbe / Colour |
|-------|-----------|------|-----|----------------|
| 00530 | 35 x 27,0 | 2 | | |
| 00535 | 41 x 30,5 | 2 | | |
| 00540 | 45 x 35,5 | 2 | | |
| 00552 | 53 x 32,5 | 2 | 1/1 | |

| | cm | ↑ cm | GN | Farbe / Colour |
|-------|-----------|------|-----|----------------|
| 00531 | 35 x 27,0 | 2 | | |
| 00536 | 41 x 30,5 | 2 | | |
| 00541 | 45 x 35,5 | 2 | | |
| 00553 | 53 x 32,5 | 2 | 1/1 | |

| | cm | ↑ cm | GN | Farbe / Colour |
|-------|-----------|------|-----|----------------|
| 00532 | 35 x 27,0 | 2 | | |
| 00537 | 41 x 30,5 | 2 | | |
| 00542 | 45 x 35,5 | 2 | | |
| 00554 | 53 x 32,5 | 2 | 1/1 | |

| | cm | ↑ cm | GN | Farbe / Colour |
|-------|-----------|------|-----|----------------|
| 00533 | 35 x 27,0 | 2 | | |
| 00538 | 41 x 30,5 | 2 | | |
| 00543 | 45 x 35,5 | 2 | | |
| 00555 | 53 x 32,5 | 2 | 1/1 | |

| | cm | ↑ cm | Farbe / Colour |
|-------|-----------|------|----------------|
| 00534 | 35 x 27,0 | 2 | |

| | cm | ↑ cm | Farbe / Colour |
|-------|-----------|------|----------------|
| 00539 | 35 x 27,0 | 2 | |



stapelbar
 stackable



Rechnungstablatt

bill presenter
porta cuenta
porte-addition

mit Klemme für Rechnung

with clip for bill
con clip para la nota
avec clip pour la note



| | cm | ↑ cm |
|-------|---------|------|
| 30108 | 20 x 12 | 1,5 |



Rechnungstablatt

bill presenter
porta cuenta
porte-addition

mit Klemme für Rechnung

with clip for bill
con clip para la nota
avec clip pour la note



| | cm | ↑ cm |
|-------|---------|------|
| 30110 | 17 x 11 | 1 |



Tischkrümelentferner

crumber
recogemigas
ramasse-miettes

geschliffene Edelstahlkante, matt poliert, einfache Handhabung

flat grinded stainless steel edge, matt polished, easy to handle
geschliffene Edelstahlkante, pulido mate, fácil de usar, mango hueco
geschliffene Edelstahlkante, poli mat, manche creux, simple à utiliser



| | Ø cm | ↑ cm |
|-------|------------|------|
| 00581 | 19,5 x 4,5 | 1 |



71400

Rezeptionsglocke

ring bell
timbre
sonnette



| | Ø cm | ↑ cm | Farbe / Colour |
|-------|------|------|----------------|
| 71400 | 8,5 | 6,0 | ■ |
| 71433 | 10,0 | 6,5 | ■ |

ASHTRAYS



Windaschenbecher

ashtray
cenicero
cendrier



Metall verchromt, Glas gefrostet, mit Bajonettverschluss

metal chrome plated, glass frosted, bayonet lock

metal cromado, opaco mate, cierre de bayoneta

métal chromé, mat, verrouillage par baïonnette

| | Ø cm | ↑ cm | Farbe / Colour |
|-------|------|------|----------------|
| 00582 | 9,5 | 8 | |
| 00583 | 9,5 | 8 | |
| 00584 | 9,5 | 8 | |
| 00585 | 9,5 | 8 | |



Windaschenbecher

ashtray
cenicero
cendrier



Metall verchromt, Glas gefrostet, mit Bajonettverschluss

metal chrome plated, glass frosted, bayonet lock

metal cromado, opaco mate, cierre de bayoneta

métal chromé, mat, verrouillage par baïonnette

| | Ø cm | ↑ cm | Farbe / Colour |
|-------|------|------|----------------|
| 00560 | 9,5 | 8 | |
| 00561 | 9,5 | 8 | |
| 00562 | 9,5 | 8 | |
| 00563 | 9,5 | 8 | |
| 00564 | 9,5 | 8 | |





Drehaschenbecher „PUSH“

ashtray
cenicero
cendrier



Deckel mit Drehmechanismus, mit Bajonettverschluss
with rotary button, bayonet lock
con botón giratorio, cierre de bayoneta
tourne par pression sur le bouton, verrouillage par baïonnette

| | Ø cm | ↑ cm |
|-------|------|------|
| 00568 | 9,5 | 11 |



Drehmechanismus
rotary button



Drehaschenbecher „KLASSIKER“

ashtray
cenicero
cendrier giratoire



Deckel mit Drehmechanismus
with rotary button
con botón giratorio
tourne par pression sur le bouton

| | Ø cm | ↑ cm | Farbe / Colour |
|-------|------|------|----------------|
| 00054 | 13,0 | 10,5 | |
| 00056 | 10,5 | 11 | |



Drehmechanismus
rotary button



Windaschenbecher

ashtray
cenicero
cendrier



Deckel hochglanzpoliert, Behälter matt poliert, mit Windschutzdeckel
lid mirror polished, container matt polished, with windcover
con tapa antiviento pulida brillante y contenedor pulido efecto pulido mate
couverture anti-vent brillant, corps poli mat poli maté

| | Ø cm | ↑ cm |
|-------|------|------|
| 00052 | 12 | 5,5 |



Klappmechanismus
rotary button



Windaschenbecher „ELEMENT“

ashtray
cenicero
cendrier



möbelschonende Unterseite
non-scratching undersurface
base anti rayaduras
avec revêtement antirayures

| | Ø cm | ↑ cm |
|--------|------|------|
| 000570 | 10,5 | 5,0 |



00091

Windaschenbecher

ashtray
cenicero
cendrier

matt poliert, mit Windschutzdeckel
matt polished, with windcover
pulido mate apilable, tapa para el viento
poli mat, empilable, couvercle anti-vent



| | Ø cm | ↑ cm |
|-------|------|------|
| 00090 | 10 | 4,5 |
| 00091 | 12 | 4,5 |



stapelbar
stackable



83488

Windaschenbecher

ashtray
cenicero
cendrier



| | Ø cm | ↑ cm | Farbe / Colour |
|-------|------|------|----------------|
| 83488 | 11,5 | 5 | white |
| 83489 | 11,5 | 5 | black |



83611

Windaschenbecher

ashtray
cenicero
cendrier



| | Ø cm | ↑ cm | Farbe / Colour |
|-------|------|------|----------------|
| 83610 | 10 | 4,0 | white |
| 83612 | 12 | 4,5 | white |
| 83611 | 10 | 4,0 | black |
| 83613 | 12 | 4,5 | black |



Windaschenbecher „SMOKY“

ashtray
cenicero
cendrier

mit abnehmbarem Deckel
with removable lid
con tapa extraible
avec couvercle amovible



| | Ø cm | ↑ cm | Farbe / Colour |
|-------|------|------|-----------------------|
| 00586 | 8,5 | 11,5 | schwarz / black |
| 00578 | 8,5 | 11,5 | verzinkt / galvanised |

ASHTRAYS



Aschenbecher

ashtray
cenicero
cendrier



| | Ø cm | ↑ cm | Farbe / Colour |
|-------|------|------|----------------|
| 83616 | 9,5 | 4,5 | ■ |



Aschenbecher

ashtray
cenicero
cendrier



matt poliert, hochwertige schwere Ausführung

matt polished, high quality, heavy gauge
pulido pulido mate, alta calidad, apilable
poli mat, empilable, belle qualité

| | Ø cm | ↑ cm |
|-------|------|------|
| 00048 | 8 | 3 |
| 00050 | 10 | 3 |



Aschenbecher, 3er Set

ashtray, 3 pcs.
set de 3 cenicero
set de 3 cendriers



| | Ø cm | ↑ cm | Farbe / Colour | pcs. |
|-------|------|------|----------------|------|
| 00576 | 8 | 3 | ■ | 3 |



Standascher „DIABOLO“

standing ashtray
cenicero de pie
cendrier sur pied



für den Innen- und Außenbereich, inklusive 1,5 kg Sand, eine Ascheschale für die Sandbefüllung und ein Metallsieb

for in,- outdoor use, included a bag of sand and a metal sieve

uso en interior o exterior, incluye una bolsa de arena y embudo de metal

usage en intérieur ou extérieur, livré avec un sac de sable et entonnoir métal

| | Ø cm | ↑ cm |
|-------|------|------|
| 00574 | 40 | 60 |



vielseitig nutzbar
versatile



zerlegbar und stapelbar
dismountable and stackable



Tretbeutelhalter

pedal bin
soporte a pedal
poubelle à pédale

geeignet für Müllbeutel bis 120 ltr., 110 x 70 cm

suitable for bags up to 120 ltr., 110 x 70 cm

apto para bolsas hasta 120 l., medidas sin bolsa 110 x 70 cm

apte pour sacs de 120 l., dim. sans sac 110 x 70 cm

| | cm | ↑ cm |
|-------|---------|------|
| 00580 | 59 x 43 | 96 |



Gummilippe 55 cm breit, Abstand zwischen Gummilippe und Bodenblech 82 cm



leichte Bedienung, Trittmechanismus
easy handling, step on bin

2 Lenkrollen mit Feststellern
2 wheels with brakes

NEW

Der nachhaltige Mehrwegbecher – made in Germany



eco-friendly



Das Ribbendesign isoliert die Hitze – kein „Verbrennen“ der Finger möglich

The rib design insulates the heat - no „burning“ of the fingers possible

Mehrwegbecher individuell mit Ihrem Logo/Namen herstellbar ab 500 Stck. – sprechen Sie uns an!

Reusable cups can be individually produced with your logo/name. From 500 pieces - please contact us!

- ✓ aufsteckbarer Deckel mit Trinköffnung
- ✓ 100% recyclebar
- ✓ spülmaschinengeeignet
- ✓ stapelbar mit und ohne Deckel
- ✓ schwappsicher

- clip-on lid with drinking opening
- 100% recyclable
- dishwasher safe
- stackable with and without lid
- slosh-/leak-proof

NEW



To Go Mehrwegbecher

To Go reusable cup
vaso reutilizable To Go
tasse réutilisable To Go
Becher (ohne Deckel)
cup (without cover)
vaso (sin tapa)
tasse (sans couvercle)



| | Ø cm | ↑ cm | ltr. | Farbe / Colour | VE / unit |
|-------|------|------|------|----------------|-----------|
| 66910 | 8,5 | 13,5 | 0,4 | | 48 |
| 66911 | 8,5 | 13,5 | 0,4 | | 48 |
| 66912 | 8,5 | 13,5 | 0,4 | | 48 |
| 66913 | 8,5 | 13,5 | 0,4 | | 48 |

Deckel / cover / tapa / couvercle

| | Ø cm | ↑ cm | Farbe / Colour | VE / unit |
|-------|------|------|----------------|-----------|
| 66914 | 8,5 | 2,5 | | 48 |
| 66915 | 8,5 | 2,5 | | 48 |
| 66916 | 8,5 | 2,5 | | 48 |
| 66917 | 8,5 | 2,5 | | 48 |

DRINKING BOTTLE



Trinkflasche drinking bottle cantimplora gourde

EDELSTAHL
STAINLESS
INOX
18/8

HOLZ
WOOD

die doppelwandige Vakuumflasche aus Edelstahl hält Heißes 12 Stunden heiß und Kaltes 24 Stunden kalt, 100% auslaufsicher

the double-walled stainless steel vacuum bottle keeps hot drinks hot for 12 hours and cold drinks cold for 24 hours, 100% leak proof

la cantimplora al vacío de acero inoxidable de doble pared mantiene las bebidas calientes durante 12 horas y las frías durante 24 horas, 100% transporte sin salpicaduras

la gourde à vide en acier inoxydable à double paroi permet de conserver les boissons chaudes pendant 12 heures et les boissons froides pendant 24 heures, 100% transport sans éclaboussures

| | Ø cm | ↑ cm | ltr. |
|-------|------|------|------|
| 66905 | 7,5 | 24,5 | 0,5 |



Trinkflasche drinking bottle cantimplora gourde

EDELSTAHL
STAINLESS
INOX
18/8

HOLZ
WOOD

die doppelwandige Vakuumflasche aus Edelstahl hält Heißes 12 Stunden heiß und Kaltes 24 Stunden kalt, 100% auslaufsicher

the double-walled stainless steel vacuum bottle keeps hot drinks hot for 12 hours and cold drinks cold for 24 hours, 100% leak proof

la cantimplora al vacío de acero inoxidable de doble pared mantiene las bebidas calientes durante 12 horas y las frías durante 24 horas, 100% transporte sin salpicaduras

la gourde à vide en acier inoxydable à double paroi permet de conserver les boissons chaudes pendant 12 heures et les boissons froides pendant 24 heures, 100% transport sans éclaboussures

| | Ø cm | ↑ cm | ltr. |
|-------|------|------|------|
| 66906 | 7,5 | 29,5 | 0,75 |



...immer dabei



mit Schraubverschluss
with screw cap

inkl. Ersatzdichtung
incl. spare gasket

500 ml

750 ml

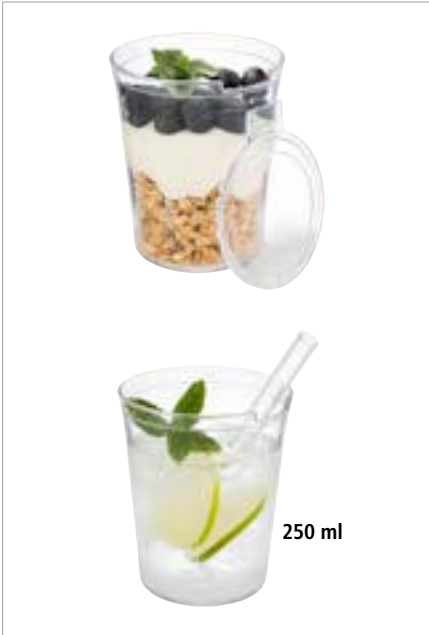

Becher Set „SUPER CUP“, 8er Set

barrel mug set, 8 pcs.
vasos, set de 8
gobelets, set de 8

Set bestehend aus 8 Bechern + 8 Deckeln
set consists of 8 barrel mugs + 8 lids
set compuesto por 8 vasos + 8 tapas
set composé de 8 gobelets + 8 couvercles



IDEAL
FÜR
„TAKE AWAY“

| | Ø cm | ↑ cm | ltr. | pcs. |
|-------|------|------|------|------|
| 10506 | 8 | 10 | 0,25 | 8 |



mit Stapelnocke
with stacking cam



rutschfester Deckel
non-slip lid



Servierbeispiel Deckel
presentation example cover



Lunchbag, 2er Set

lunch bag, 2 pcs.
bolsa de almuerzo, set de 2
sac à lunch, set de 2

70% Naturfaser und 30% Kunstharz, mit Klettverschluss

70% natural fibre and 30% synthetic resin, with velcro fastener

70% fibra natural y 30% resina sintética, con cierre de velcro

70% de fibres naturelles et 30% de résine synthétique, avec fermeture velcro



| | cm | ↑ cm | pcs. |
|-------|---------|------|------|
| 30357 | 16 x 10 | 32 | 2 |
| 30358 | 25 x 15 | 30 | 2 |



Präsentationsmöglichkeit
presentation example





Lunchbox



Lunchbox „M“
lunchbox
fiambrella
boîte à lunch



Edelstahlbox mit Silikondichtung inkl. Trennsteg, auslaufsicher

stainless steel box with silicone seal incl. divider, leak-proof
caja de acero inoxidable con junta de silicona y divisor extraíble, transporte sin salpicaduras
boîte en acier inox avec joint en silicone et diviseur amovible, transport sans éclaboussures

| | cm | ↑ cm | ltr. |
|-------|-------------|------|------|
| 66900 | 18,5 x 13,5 | 6,5 | 0,8 |



Lunchbox „L“
lunchbox
fiambrella
boîte à lunch



Edelstahlbox mit Silikondichtung inkl. Trennsteg, auslaufsicher

stainless steel box with silicone seal incl. divider, leak-proof
caja de acero inoxidable con junta de silicona y divisor extraíble, transporte sin salpicaduras
boîte en acier inox avec joint en silicone et diviseur amovible, transport sans éclaboussures

| | cm | ↑ cm | ltr. |
|-------|-------------|------|------|
| 66901 | 20,5 x 14,5 | 6,5 | 1,1 |







Lunchbox „XL“
lunchbox
fiambrella
boîte à lunch



Edelstahlbox mit Silikondichtung inkl. Trennsteg, auslaufsicher

stainless steel box with silicone seal incl. divider, leak-proof
caja de acero inoxidable con junta de silicona y divisor extraíble, transporte sin salpicaduras
boîte en acier inox avec joint en silicone et diviseur amovible, transport sans éclaboussures

| | cm | ↑ cm | ltr. |
|-------|-------------|------|------|
| 66902 | 22,5 x 16,5 | 6,5 | 1,4 |

| | | | |
|--|--|--|--|
|  mit zwei Verschlüssen with 2 clasps 66900 0,8 ltr. |  66901 1,1 ltr. |  66902 1,4 ltr. |  herausnehmbarer Trennsteg removable divider auslaufsicher leak-proof |
|--|--|--|--|





Servier- & Küchenhelfer

serving items & kitchentools

herramientas de cocina

outils de cuisine

| | |
|---|-----|
| BANQUET..... | 438 |
| PROFI..... | 440 |
| CLASSIC..... | 441 |
| STOP TOOLS..... | 442 |
| POLYAMIDE KITCHENTOOLS..... | 444 |
| TONGS..... | 446 |
| TWEEZERS..... | 452 |
| DELICATESSEN SPOONS..... | 453 |
| SPOONS WOOD..... | 454 |
| ORANGE..... | 456 |
| BLUE..... | 459 |
| CUTTERS WHISKS..... | 462 |
| STRAINERS..... | 463 |
| CONFECTIONARY KITCHENTOOLS..... | 466 |
| MEASURING CUPS..... | 467 |
| STIRRING CUPS MOUSSE RINGS..... | 468 |
| DARIOL MOULDS CAKE SETTING RINGS DISPLAY TRAYS... | 469 |
| BUCKETS SCOOPS..... | 470 |
| FUNNELS..... | 471 |
| SQUEEZERS BRUSHES BREADING SETS..... | 472 |
| BILL RAILS KNIFE RACKS TEAR-OFF-DISPENSERS..... | 473 |
| KITCHEN TOOLS..... | 474 |
| SQUEEZE BOTTLES..... | 475 |
| DISPENSERS EGG BOXES..... | 477 |
| PIZZA..... | 478 |

BANQUET



Die Vorlegeserie BANQUET ist die passende Ergänzung zum Servieren am Buffet. Durch die mattierte Oberfläche und das gebogene Griffende wird BANQUET praktischen und optischen Ansprüchen gerecht.

The series BANQUET is the perfect addition for serving at the buffet. Due to the matt surface and the curved handle, BANQUET meets practical and optical requirements.

La serie BANQUET es la adición perfecta para servir en el buffet. Debido a la superficie mate y al mango curvado, BANQUET cumple con requisitos prácticos y ópticos.

La série BANQUET est l'ajout parfait pour servir au buffet. Grâce à la surface mate et la poignée incurvée, BANQUET répond aux exigences pratiques et optiques.



Salat- / Servierlöffel „BANQUET“

salad spoon / serving spoon
cuchara para ensalada / cuchara de servicio
cuillère à salade / cuillère de service



| | cm | Griff / handle cm |
|-------|---------|-------------------|
| 00588 | 6 x 5 | 17 |
| 00590 | 7,5 x 6 | 21 |



Salatgabel „BANQUET“

salad fork
tenedor de servicio para ensalada
fourchette de service pour la salade



| | cm | Griff / handle cm |
|-------|---------|-------------------|
| 00589 | 6 x 5 | 17 |
| 00591 | 7,5 x 6 | 21 |



00589



00591



Schöpflöffel „BANQUET“

ladle
cucharón
louche



| | cm | Griff / handle cm |
|-------|-----------|-------------------|
| 00595 | 8,5 x 7,5 | 24 |



Chafing Dish Löffel „BANQUET“

serving spoon
cuchara para servir
cuillère de service



| | cm | Griff / handle cm | |
|-------|----------|-------------------|----------------------|
| 00592 | 11 x 6,5 | 24 | |
| 00593 | 11 x 6,5 | 24 | geschlitzt / slotted |



00593



Dressinglöffel „BANQUET“

dressing spoon
cuchara de aliño
cuillère à vinaigrette



| | cm | Griff / handle cm |
|-------|-------|-------------------|
| 00594 | 6 x 4 | 30 |



Pfannenwender „BANQUET“

turner
espátula
spatule



| | cm | Griff / handle cm |
|-------|----------|-------------------|
| 00587 | 10 x 7,5 | 21 |



Fleischgabel „BANQUET“

meat fork
tenedor de carne
fourchette à viande



| | cm | Griff / handle cm |
|-------|---------|-------------------|
| 00596 | 8 x 2,5 | 13 |



Serviergabel „BANQUET“

fork
tenedor de servicio
fourchette de service



| | cm | Griff / handle cm |
|-------|-------|-------------------|
| 00597 | 9 x 4 | 21 |



Tortenheber „BANQUET“

cake lifter
pala de tartas
pelle à gâteau
eine Kante gezahnt
one edge serrated
un borde serrado
denté sur un côté



| | cm | Griff / handle cm |
|-------|--------|-------------------|
| 00598 | 14 x 6 | 13 |

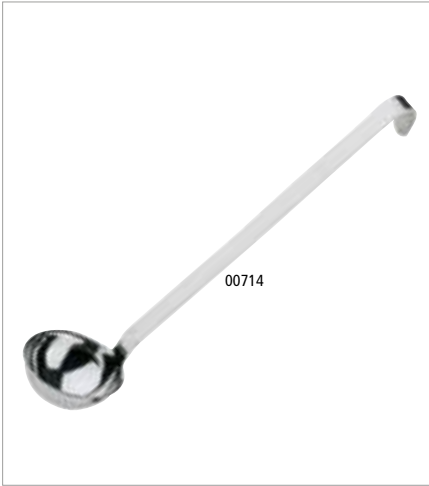

Schöpflöffel „PROFI“

ladle
cacillo
louche



| | Ø cm | Griff / handle cm | litr. |
|-------|------|-------------------|-------|
| 00711 | 6 | 28 | 0,050 |
| 00712 | 7 | 30 | 0,080 |
| 00713 | 8 | 32 | 0,125 |
| 00714 | 9 | 33 | 0,150 |
| 00715 | 10 | 35 | 0,250 |
| 00716 | 11 | 36 | 0,300 |



Schaumlöffel „PROFI“

skimmer
espumadera
écumoire



| | Ø cm | Griff / handle cm |
|-------|------|-------------------|
| 00721 | 10 | 34 |
| 00722 | 12 | 37 |
| 00723 | 14 | 40 |



Wender „PROFI“

turner
espátula
spatule



| | cm | Griff / handle cm |
|-------|-----------|-------------------|
| 00730 | 10 x 11,5 | 38 |



Servierlöffel „PROFI“

serving spoon
cuchara de servicio
cuillère de service



| | cm | Griff / handle cm | |
|-------|--------|-------------------|----------------------|
| 00671 | 11 x 7 | 29 | geschlitzt / slotted |
| 00672 | 11 x 7 | 29 | |



Spaghettilöffel „PROFI“

spaghetti spoon
cuchara de espaguetis
cuillère à spaghettis



| | cm | Griff / handle cm |
|-------|--------|-------------------|
| 00673 | 10 x 7 | 29 |



Servierlöffel „CLASSIC“

servicing spoon
cuchara de servicio
cuillère de service



hochglanzpoliert, perforiert, Löcher Ø 4 mm, ergonomisch profilierter Hohl-Griff
mirror polished, perforated, holes Ø 4 mm, ergonomic designed handle
pulido brillante agujeros de Ø 4 mm, asa ergonómica
brillant, trous Ø 4 mm, manche ergonomique

| | cm | Griff / handle cm |
|-------|---------|-------------------|
| 75903 | 9,5 x 7 | 23,5 |



Salatlöffel „CLASSIC“

salad spoon
cuchara para ensalada
cuillère à salade



hochglanzpoliert, ergonomisch profilierter Hohl-Griff
mirror polished, ergonomic designed handle
pulido brillante, asa ergonómica
poli brillant, manche ergonomique

| | cm | Griff / handle cm |
|-------|---------|-------------------|
| 75902 | 8 x 6 | 21,5 |
| 75904 | 9,5 x 7 | 23,5 |



Suppenkelle „CLASSIC“

soup ladle
cucharón de sopa
louche de service



hochglanzpoliert, ergonomisch profilierter Hohl-Griff
mirror polished, ergonomic designed handle
pulido brillante, asa ergonómica
poli brillant, manche ergonomique

| | Ø cm | Griff / handle cm | litr. |
|-------|------|-------------------|-------|
| 75907 | 7 | 23 | 0,06 |
| 75908 | 9 | 24 | 0,1 |



Saucengießlöffel „CLASSIC“

sauce / gravy ladle
cucharón de salsa
cuillère à sauce



hochglanzpoliert, ergonomisch profilierter Hohl-Griff, fugenlos
mirror polished, ergonomic designed handle, seamless
pulido brillante, asa ergonómica, sin soldadura
poli brillant, manche ergonomique, monobloc (sans soudure)

| | cm | Griff / handle cm | litr. |
|-------|---------|-------------------|-------|
| 75906 | 7 x 5,5 | 22 | 0,02 |



Tortenheber „CLASSIC“

cake lifter
pala de tartas
pelle à gâteau



hochglanzpoliert, mit einer gezahnten Kante, ergonomisch profilierter Hohl-Griff
mirror polished, one edge serrated, ergonomic designed handle
pulido brillante, canto dentado, mango ergonómico
poli brillant, bord microdenté, manche ergonomique

| | cm | Griff / handle cm |
|-------|-------|-------------------|
| 75900 | 8 x 5 | 10,5 |
| 75912 | 5 x 1 | 12 |

STOP-TOOLS

Die STOP-Funktion verhindert, dass Gabel oder Löffel in das Gefäß rutschen.

The smart STOP-function prevent forks and spoon not to slip into the vessel.

La función STOP evita que los cubiertos se caigan dentro del recipiente.

La fonction STOP empêche les couverts de glisser dans le récipient.



Servierlöffel

serving spoon
cuchara para servir
cuillère à servir



Materialdicke 2,5 mm, ergonomischer, rutschfester Griff
material thickness: 2,5 mm, ergonomic antislip handle
grosor: 2,5 mm, mango ergonómico antideslizante
épaisseur : 2,5 mm, poignée ergonomique antidérapante

| | cm | Griff / handle cm |
|-------|----------|-------------------|
| 00834 | 10 x 7,5 | 17 |



Servierlöffel geschlitzt

slotted spoon
cuchara para servir ranurada
cuillère à servir rainurée



Materialdicke 2,5 mm, ergonomischer, rutschfester Griff
material thickness: 2,5 mm, ergonomic antislip handle
grosor: 2,5 mm, mango ergonómico antideslizante
épaisseur : 2,5 mm, poignée ergonomique antidérapante

| | cm | Griff / handle cm |
|-------|----------|-------------------|
| 00833 | 10 x 7,5 | 17 |



Schöpflöffel

ladle
cucharón
louche



Materialdicke 2,5 mm, ergonomischer, rutschfester Griff
material thickness: 2,5 mm, ergonomic antislip handle
grosor: 2,5 mm, mango ergonómico antideslizante
épaisseur : 2,5 mm, poignée ergonomique antidérapante

| | Ø cm | Griff / handle cm |
|-------|------|-------------------|
| 00832 | 9 | 17 |



Fleischgabel

meat fork
tenedor de carne
fourchette à viande



Materialdicke 2,5 mm, ergonomischer, rutschfester Griff
material thickness: 2,5 mm, ergonomic antislip handle
grosor: 2,5 mm, mango ergonómico antideslizante
épaisseur : 2,5 mm, poignée ergonomique antidérapante

| | cm | Griff / handle cm |
|-------|----------|-------------------|
| 00831 | 10,5 x 4 | 17 |

**Servierlöffel geschlitzt**

slotted spoon
cuchara para servir ranurada
cuillère à servir rainurée

ergonomischer, rutschfester Griff

ergonomic antislip handle
mango ergonómico antideslizante
poignée ergonomique antidérapante



| | cm | Griff / handle cm |
|-------|--------|-------------------|
| 00664 | 11 x 7 | 25 |

**Servierlöffel**

serving spoon
cuchara para servir
cuillère à servir

ergonomischer, rutschfester Griff

ergonomic antislip handle
mango ergonómico antideslizante
poignée ergonomique antidérapante



| | cm | Griff / handle cm |
|-------|--------|-------------------|
| 00662 | 11 x 7 | 25 |

**Schöpföffel**

ladle
cucharón
louche

ergonomischer, rutschfester Griff

ergonomic antislip handle
mango ergonómico antideslizante
poignée ergonomique antidérapante



| | cm | Griff / handle cm | ltr. |
|-------|-------|-------------------|------|
| 00670 | 9 x 8 | 25 | 0,10 |

**Wender**

turner
espátula
spatule

ergonomischer, rutschfester Griff

ergonomic antislip handle
mango ergonómico antideslizante
poignée ergonomique antidérapante



| | cm | Griff / handle cm |
|-------|--------|-------------------|
| 00668 | 10 x 8 | 25 |

**Fleischgabel**

meat fork
tenedor de carne
fourchette à viande

ergonomischer, rutschfester Griff

ergonomic antislip handle
mango ergonómico antideslizante
poignée ergonomique antidérapante



| | cm | Griff / handle cm |
|-------|----------|-------------------|
| 00666 | 10 x 3,5 | 25 |

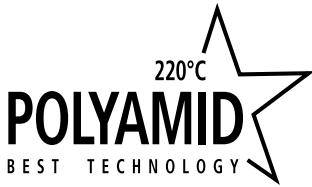

Das Profimaterial Polyamid besteht aus Nylon und Fiberglas. Hitzebeständig bis 220°C, extra hochwertige Profi-Qualität, gut geeignet für antihafbeschichtete Pfannen, ergonomischer Griff.



Polyamide is made of nylon and fiberglass. Heat-resistant up to 220°C, extra high quality, perfect for non-stick-coated pots and pans, ergonomic handle.

Poliamide de nylon y fibra de vidrio. Brevemente al calor hasta 220°, calta calidad profesional, ideal para sartenes antiadherentes, mango ergonómico.



Polyamide de nylon et fibre de verre, haute résistance brièvement à la chaleur jusque 220°C, qualité professionnelle, idéal pour les poêles antiadhérentes, manche ergonomique.



Bratenwender
turner
espátula
spatule



| | cm | Griff / handle cm |
|-------|----------|-------------------|
| 00603 | 11 x 9,5 | 23 |



Pfannenwender
turner
espátula
spatule



| | cm | Griff / handle cm |
|-------|------------|-------------------|
| 00600 | 11,5 x 9,5 | 23 |



Pfannenwender
turner
espátula
spatule



| | cm | Griff / handle cm |
|-------|----------|-------------------|
| 00604 | 15 x 7,5 | 15 |



Pfannenwender
turner
espátula
spatule



| | cm | Griff / handle cm |
|-------|----------|-------------------|
| 88642 | 13,5 x 9 | 18 |



Pfannenwender
turner
espátula
spatule



| | cm | Griff / handle cm |
|-------|----------|-------------------|
| 88640 | 13 x 6,5 | 15 |



Servierlöffel
 serving spoon
 cuchara de servicio
 cuillère de service



| | cm | Griff / handle cm | |
|-------|--------|-------------------|------------|
| 88608 | 12 x 7 | 23 | |
| 00607 | 12 x 7 | 23 | perforiert |



Schaumlöffel
 skimmer
 espumadera
 écumoire



| | Ø cm | Griff / handle cm |
|-------|------|-------------------|
| 00602 | 11,5 | 23 |



Schöpflöffel
 ladle
 cucharón
 louche



| | Ø cm | Griff / handle cm | ltr. |
|-------|------|-------------------|------|
| 00606 | 9 | 23 | 0,1 |



Toastzange
 sandwich tongs
 pinzas para sandwich
 pince à toasts



| | cm | Griff / handle cm |
|-------|--------|-------------------|
| 00601 | 11 x 8 | 18 |



Salatzange
 salad tongs
 pinzas para ensalada
 pince à salade



| | cm | Griff / handle cm |
|-------|--------|-------------------|
| 00605 | 10 x 6 | 23 |



Spaghettizange
 spaghetti tongs
 pinzas para espaguetis
 pince à spaghettis



| | cm | Griff / handle cm |
|-------|-------|-------------------|
| 88637 | 9 x 9 | 15 |



Salatzange „TIDLOS“

salad tong
pinza ensalada
pince à salade

hochglanzpoliert, einseitig geschlitzt
mirror polished, slotted on one side
pulido brillante, agujereada en un lado
poli brillant, perforée d'un seul côté



| | cm | → cm |
|-------|-------|------|
| 75842 | 5 x 2 | 22 |



Pastazange „TIDLOS“

pasta tongs
pinza espaguetis
pince à spaghettis

hochglanzpoliert, beidseitig geschlitzt
mirror polished, slotted on both side
pulido brillante, agujereada en 2 lados
poli brillant, perforéedes 2 côtés



| | cm | → cm |
|-------|---------|------|
| 75843 | 8 x 5,5 | 22,5 |



Spargelzange „TIDLOS“

asparagus tongs
pinzas para espárragos
pince à asperges

hochglanzpoliert / mirror polished / pulido brillante / poli brillant



| | cm | → cm |
|-------|--------|------|
| 75844 | 7 x 11 | 24,5 |



Gebäckzange „TIDLOS“

pastry tongs
pinza para pasteles
pince à gâteaux

hochglanzpoliert / mirror polished / pulido brillante / poli brillant



| | cm | → cm |
|-------|-----------|------|
| 75840 | 6,5 x 4,5 | 21 |



Servierzange „TIDLOS“

serving tongs
pinza universal
pince universelle

hochglanzpoliert / mirror polished / pulido brillante / poli brillant



| | cm | → cm |
|-------|---------|------|
| 75841 | 7 x 4,5 | 21 |



Salatzange

salad serving tong
pinza de ensalada
pince à servir la salade

hochglanzpoliert, einfache Handhabung

mirror polished, convenient handling
pulido brillante, manejo cómodo
poli brillant, manipulation aisée



| | cm | → cm |
|-------|-----------|------|
| 00685 | 7,0 x 4,5 | 25 |



Universalzange

all - purpose tong
pinzas multiusos
pince multi-usages

hochglanzpoliert, einfache Handhabung

mirror polished, convenient handling
pulido brillante, manejo cómodo
poli brillant, manipulation aisée



| | cm | → cm |
|-------|-----------|------|
| 00688 | 7,0 x 4,5 | 25 |



Brot- und Gebäckzange

bread and pastry tong
pinza para pan y bollería
pince à pain ou viennoiseries

hochglanzpoliert, einfache Handhabung

mirror polished, convenient handling
pulido brillante, manejo cómodo
poli brillant, manipulation aisée



| | cm | → cm |
|-------|-----------|------|
| 00686 | 7,0 x 4,5 | 25 |



Brot- und Gebäckzange

bread and pastry tong
pinza para pan y bollería
pince à pain ou viennoiseries

hochglanzpoliert, einfache Handhabung

mirror polished, convenient handling
pulido brillante, manejo cómodo
poli brillant, manipulation aisée



| | cm | → cm |
|-------|-----------|------|
| 00687 | 7,0 x 4,5 | 25 |



Universalzange
all-purpose tong
pinza universal
pince universelle



| | cm | → cm | Farbe / Colour | € |
|-------|-------|------|-----------------|---|
| 75825 | 7 x 5 | 22,5 | vintage-look | |
| 75830 | 7 x 5 | 25 | mirror polished | |
| 75831 | 7 x 5 | 25 | gold-look | |
| 75832 | 7 x 5 | 25 | copper-look | |



Universalzange
all-purpose tong
pinza universal
pince universelle



hochglanzpoliert, mit Befestigungsclip
mirror polished, with fastening clip
pulido brillante, con clip de fijación
poli brillant, avec clip de fixation

| | → cm | Farbe / Colour |
|-------|------|-----------------|
| 75850 | 19,5 | mirror polished |
| 75851 | 19,5 | copper-look |
| 75852 | 19,5 | gunmetal-look |



Zange kann an einer Schale befestigt werden
tongs can be attached to a bowl



Eiszange
ice tongs
pinzas para hielo
pince de la glace



hochglanzpoliert, mit Befestigungsclip
mirror polished, with fastening clip
pulido brillante, con clip de fijación
poli brillant, avec clip de fixation

| | → cm | Farbe / Colour |
|-------|------|-----------------|
| 75853 | 20 | mirror polished |
| 75854 | 20 | copper-look |
| 75855 | 20 | gunmetal-look |



Zange kann an einer Schale befestigt werden
tongs can be attached to a bowl



Salatzange

salad tong
pinza ensalada
pince à salade



hochglanzpoliert, beidseitig geschlitzt / mirror polished, slotted on both side
pulido brillante, agujereada en 2 lados / poli brillant, perforéedes 2 côtés

| | cm | → cm |
|-------|-------|------|
| 75801 | 5 x 2 | 24 |



Universalzange

all-purpose tong
pinza universal
pince universelle



Edelstahl, Antik-Edelstahl-Look / Vintage-Look

stainless steel, stainless antique look
acero inoxidable, acero estilo antiguo
acier inox, acier style antique

| | cm | → cm | Farbe / Colour |
|-------|-----------|------|----------------|
| 75823 | 5,5 x 5,0 | 20,0 | vintage-look |
| 75824 | 7,0 x 5,0 | 22,5 | vintage-look |



Vorspeisenzange „BANQUET“

appetizer tong
pinza para aperitivos
pince à apéritif



Vorderteil poliert, Stiel mattiert

front part: high-shiny, handle: matt-finish
parte delantera pulida, asa mate
partie avant polie, poignée matte

| | cm | → cm |
|-------|-----------|------|
| 75822 | 4,5 x 3,5 | 20 |



ideal für Vorspeisen
ideal for starters



Spaghettizange

spaghetti tong
pinza espaguetis
pince à spaghetti



hochglanzpoliert, fugenlos

mirror polished, seamless
pulido brillante, sin soldaduras
poli brillant, monobloc

| | cm | → cm |
|-------|-------|------|
| 75810 | 6 x 3 | 19 |



Aufschnitt- / Allzweckzange

sausage tong
pinza salchichas
pince à saucisses

hochglanzpoliert, fugenlos
mirror polished, seamless
pulido brillante, sin soldadura
poli brillant, monobloc



| | cm | → cm |
|-------|---------|------|
| 75806 | 3 x 2,5 | 16 |



Allzweckzange

multipurpose tong
pinza multi-usos
pince universelle multi-usages

hochglänzend, mit Feder und Verschlusschieber, dekorative Greiferform
mirror polished, with spring and retaining clip, decorative gripper form
pulido brillante, con muelle y cierre deslizante, gancho con forma decorativa
poli brillant, avec mécanisme de verrouillage, forme de pince décorative



| | cm | → cm |
|-------|-------|------|
| 88643 | 4 x 3 | 24 |
| 88644 | 4 x 3 | 30 |
| 88645 | 4 x 3 | 40 |



Universalzange

all - purpose tong
pinza universal
pince universelle

hochglanzpoliert, einseitig geschlitzt
mirror polished, slotted on one side
pulido brillante, agujereada en un lado
poli brillant, perforée d'un seul côté



| | cm | → cm |
|-------|-------|------|
| 75800 | 5 x 2 | 24 |



Gebäckzange

pastry tong
pinza para pasteles
pince à gâteaux

hochglanzpoliert, fugenlos, extra schwere Qualität
mirror polished, seamless, extra heavy gauge
pulido brillante, sin soldadura, alta calidad, resistente
poli brillant, monobloc, qualité extra, robuste



| | cm | → cm |
|-------|---------|------|
| 75807 | 8,5 x 4 | 27,5 |

**Gebäck- / Tortenzange**

pastry tong
pinza para pasteles
pinçe à gâteaux

hochglanzpoliert, fugenlos
mirror polished, seamless
pulido brillante, sin soldadura
poli brillant, monobloc



| | cm | → cm |
|-------|---------|------|
| 75803 | 7 x 3,5 | 17,5 |

**Gebäckzange**

pastry tong
pinza para pasteles
pinçe à gâteaux

hochglanzpoliert, perforiert
mirror polished, perforated
pulido brillante, perforado
poli brillant, perforée



| | cm | → cm |
|-------|---------|------|
| 75804 | 6,5 x 3 | 19,5 |

**Eisportionierer**

ice cream scoop
cuchara para helado
cuillère à glace

hochglanzpoliert, mit Edelstahlfeder (physikalisch bedingt nicht korrosionsbeständig)
mirror polished, spring steel, spring is not stainless
pulido brillante, muelle de acero especial, no resistente al óxido
poli brillant, ressort acier spécial, non résistant à l'oxydation



| | Ø cm | → cm | ltr. |
|-------|------|------|------|
| 71006 | 6,5 | 23,5 | 1/12 |
| 71005 | 6,0 | 22,5 | 1/16 |
| 71004 | 5,5 | 22,0 | 1/20 |
| 71003 | 5,0 | 22,0 | 1/24 |
| 71002 | 5,0 | 21,5 | 1/30 |
| 71001 | 4,5 | 21,0 | 1/36 |

**Messlöffelsatz**

set measuring spoon
juego de cucharas medidoras
jeu de cuillère à mesure

Löffel hochglanzpoliert, Stiele matt poliert, Skalierung:
1 Esslöffel, 1 Teelöffel, 1/2 Teelöffel, 1/4 Teelöffel

bowl mirror polished, handles matt polished, measures:
table spoon, tea spoon, 1/2 tea spoon, 1/4 tea spoon

bol medidor brillante, mango mate medidas:

1 cuchara de sopa, 1 cuchara de té, 1/2 cuchara de té, 1/4 cuchara de té
corps brillant, manche mat, mesures:

1 cuillerée à soupe, 1 cuillerée à thé, 1/2 cuillère à thé, 1/4 de cuillère à thé



| | cm |
|-------|----------|
| 75600 | 14 x 4,5 |



Pinzettenzange

fine tong / tweezer
pinza de emplatar
pince à dresser

hochglanzpoliert, geriffelte Grifffläche, schwere Qualität

mirror polished, ribbed handle, heavy gauge
pulido brillante, mango cómodo ranurado, alta calidad
poli brillant, manche rainuré antiglisse, qualité extra



→ cm

75820

16



Pinzettenzange

fine tong / tweezer
pinza de emplatar
pince à dresser

hochglanzpoliert, geriffelte Grifffläche, schwere Qualität

mirror polished, ribbed handle, heavy gauge
pulido brillante, mango cómodo ranurado, alta calidad
poli brillant, manche rainuré antiglisse, qualité extra



→ cm

75821

30



Pinzettenzange

fine tong / tweezer
pinza de emplatar
pince à dresser

hochglanzpoliert, geriffelte Grifffläche, schwere Qualität

mirror polished, ribbed handle, heavy gauge
pulido brillante, mango cómodo ranurado, alta calidad
poli brillant, manche rainuré antiglisse, qualité extra



→ cm

75809

30



Pinzettenzange

fine tong / tweezer
pinza de emplatar
pince à dresser

hochglanzpoliert, geriffelte Grifffläche, abgerundete Spitzen vorne, schwere Qualität

mirror polished, ribbed handle, rounded on the tops, heavy gauge
pulido brillante, mango cómodo ranurado, alta calidad, puntas redondeadas
poli brillant, manche rainuré antiglisse, qualité extra, pointes arrondies



→ cm

75808

14,5



Gourmetlöffel/-gabel, 6er Set

tapas spoon / fork, 6 pcs.
cuchara / tenedor de tapas, set de 6
cuillère / fourchette à tapas, set de 6

kann als Löffel oder Gabel verwendet werden

can be used as a spoon or fork
puede utilizarse como cuchara o tenedor
peut être utilisé comme une cuillère ou une fourchette



| | → cm | pcs. |
|-------|------|------|
| 00699 | 10 | 6 |



Feinkost- / Olivenlöffel, 6er Set

delicatessen / olives spoon, 6 pcs.
cuchara gourmet / para aceitunas, set de 6
cuillère gourmet / à olives, set de 6

gelocht
perforated
perforadas
perforées



| | cm | → cm | pcs. | Farbe / Colour |
|-------|-------|------|------|----------------|
| 88598 | 6 x 9 | 27 | 6 | ■ |



Feinkostlöffel, 6er Set

delicatessen spoon, 6 pcs.
cuchara gourmet, set de 6
cuillère gourmet, set de 6

aus Kunststoff
plastic
plástico
plastique



| | Ø cm | → cm | pcs. | Farbe / Colour |
|-------|------|------|------|----------------|
| 88627 | 6 | 23 | 6 | ■ |
| 88628 | 6 | 23 | 6 | ■ |



Dressinglöffel

dressing spoon
cuchara de aliño
cuillère à sauce

aus Kunststoff
plastic
plástico
plastique



| | Ø cm | → cm | ltr. | Farbe / Colour |
|-------|------|------|------|----------------|
| 88636 | 6 | 34 | 0,05 | ■ |
| 88609 | 6 | 34 | 0,05 | ■ |



Salatbesteck „OLIVE“, 2er Set

spoon, 2 pcs.
cuchara, set de 2
cuillère, set de 2

aus Olivenholz
olive wood
madera de olivo
en bois d'olivier



| | cm | → cm |
|-------|-----------|------|
| 00841 | 9,5 x 8,5 | 17,0 |
| 00842 | 7,5 x 6,0 | 22,5 |



Anwendungsbeispiel
application example



Anwendungsbeispiel
application example



Löffel „OLIVE“

spoon
cuchara
cuillère

aus Olivenholz, ideal für Reis, Gemüse...
olive wood, ideal for rice, vegetables...
madera de olivo, ideal para arroz, verduras...
en bois d'olivier, idéal pour le riz, les légumes...



| | cm | → cm |
|-------|-----------|------|
| 00840 | 9,5 x 8,5 | 17,0 |



Schaufel „OLIVE“

scoop
pala
pelle

aus Olivenholz, ideal für Gewürze, Körner etc.
olive wood, ideal for spices, grains etc.
madera de olivo, ideal para especias, granos etc.
en bois d'olivier, idéal pour les épices, céréales, etc.



| | → cm |
|-------|------|
| 01020 | 13,5 |





Löffel „OLIVE“, 2er Set

spoon, 2 pcs.
cuchara, set de 2
cuillère, set de 2

aus Olivenholz, ideal für Gewürze
olive wood, ideal for spices
madera de olivo, ideal para especias
en bois d'olivier, idéal pour les épices



| | → cm | pcs. |
|-------|------|------|
| 01018 | 14 | 2 |



Honiglöffel „OLIVE“

honey spoon
cuchara de miel
cuillère à miel

aus Olivenholz
olive wood
madera de olivo
en bois d'olivier



| | → cm |
|-------|------|
| 01019 | 15 |



Löffel „ACACIA“

spoon
cuchara
cuillère

aus Akazienholz, ideal für Reis, Gemüse...
acacia wood, ideal for rice, vegetables...
madera de acacia, ideal para arroz, verduras...
bois d'acacia, idéal pour le riz, les légumes...



| | cm | → cm |
|-------|---------|------|
| 00599 | 9 x 6,5 | 23,5 |



Schaufel

scoop
pala
pelle

aus geöltem Eichenholz, mit Kunstlederband, ideal für Gewürze, Körner etc.
made of oiled oak wood, with leatherette strap, ideal for spices, grains etc.
de madera de roble aceitada, con correa de polipiel, ideal para especias, granos etc.
en bois de chêne huilé, avec bracelet en simili-cuir, idéal pour les épices, céréales, etc.



| | cm | ↑ cm |
|-------|----------|------|
| 01026 | 25,5 x 6 | 4,5 |



Anwendungsbeispiel
application example



Kugelausstecher - doppelt „ORANGE“

melon baller - double
vaciador doble de bola
moule à boule double



zum Formen von Kugeln aus Obst, Gemüse oder Butter, Edelstahl mit geschärften Rändern
to form balls out of fruits, vegetables, butter, etc., stainless steel with sharpened edge
para hacer bolas con frutas, verduras, mantequilla, etc. acero inoxidable con borde afilado
pour faire des boules de fruits, légumes, beurre, etc. inox, bord affûté

| | ∅ cm | → cm |
|-------|-----------|------|
| 88810 | 2,2 + 2,5 | 16,5 |
| 88811 | 2,2 + 3,0 | 17 |



Fadenschneider / Zester „ORANGE“

decorator / zester
cuchillo de decoración cincelador
couteau zesteur



zum Abziehen von feinsten Schalenstreifen, ideal zum Dekorieren von Torten und Desserts
to peel off very fine stripes of paring, these stripes are ideal to decorate desserts, cakes, etc.
para pelar tiras muy finas, ideal para decorar postres, tartas, etc.
pour couper en lanières fines, idéal pour la décoration de gâteaux et desserts, etc.

| | ∅ cm | → cm |
|-------|-----------|------|
| 88823 | 0,2 + 0,5 | 14,5 |



Ziseliermesser „ORANGE“

canele / decorating knife
cuchillo de decoración cincelador acanalado
couteau zesteur cannelé



zum Einritzen von Linien und Mustern in hartschaliges Obst und Gemüse, Edelstahl mit geschärften Rändern
to score lines or design in hard fruits and vegetables, stainless steel with sharpened edge
para dibujar líneas en frutas o verduras de piel dura, acero inoxidable con borde afilado
pour découper des lignes et motifs sur fruits et légumes à peau dure ou pour peler les zestes des citrons ou oranges, inox, bord affûté

| | → cm |
|-------|------|
| 88826 | 15 |



Sparschäler „ORANGE“

peeler
pelador
peleur



für Links- und Rechtshänder geeignet, mit zwei starren Klingen aus extra geschärftem + gehärtetem Edelstahl
useable left- and right handed, with 2 inflexible blades made out off sharpened, extra hardened stainless steel
para diestros y zurdos, con 2 cuchillas rígidas inox afiladas y muy resistentes
pour gauchers ou droitiers, 2 lames rigides affûtés en inox extra-résistant

| | → cm |
|-------|------|
| 88827 | 17 |

**Pendelschäler „ORANGE“**

swivel peeler
pelador reversible
éplucheur droitier/gaucher

für Links- und Rechtshänder, ideal für das Schälen von Tomaten, mit 2 beweglichen Klingen

suitable for right and left handed, ideal to peel tomatoes, with 2 flexibles blades

apto para diestros y zurdos, ideal para pelar tomates, con 2 hojas flexibles

pour gauchers ou droitiers, idéal pour peler les tomates, 2 lames flexibles



→ cm

88850

16,5

**Cocktailmesser „ORANGE“**

bar knife
cuchillo para cóctel
couteau cocktail

mit 2 Zinken zum Aufspießen von Zitrusseiben

with 2 prongs to pick up slices of lemon

con 2 dientes para pinchar las rodajas de limón, etc.

avec 2 dents pour les rondelles de citron et autres décorations



→ cm

88846

21

**Pizzateigschneider „ORANGE“**

pizza cutter
cortador de pizza
roulette à pizza

zum einfachen Zerteilen von Pizza

to cut pizza easily

para cortar pizza fácilmente

pour une coupe facile de la pizza



∅ cm → cm

88829

6

18,5

**Pendelschäler „ORANGE“**

swivel peeler
pelador lama pivotante
peleur lame pivotante

zum schnellen und sparsamen Schälen von Obst und Gemüse, mit beweglicher Klinge

to peel fruits and vegetables with flexible blade

para pelar frutas y verduras con hoja flexible

pour couper des fruits et légumes avec lame flexible



→ cm

88834

17

**Apfelentkerner „ORANGE“**

apple corer
descorazonador de manzana
vide-pomme

durch leichtes Drehen kann das Kerngehäuse von Äpfeln, Birnen und anderen Früchten sorgsam herausgeholt werden, Edelstahl mit geschärften Rändern

with a light turn cores of apples, pears and other fruits

can be cut off easily, stainless steel with sharpened edge

para descorazonar muy fácilmente manzanas, peras y otras frutas

pour évider facilement les pommes, poires ou autres fruits



∅ cm → cm

88836

2,2

21



Austernöffner „ORANGE“

oyster knife
 abre ostras
 couteau à huîtres



zum einfachen Aufbrechen von Austern, mit Fingerschutz, Edelstahl mit geschärften Rändern
 to open oysters easily, with guard, stainless steel with sharpened edge
 para abrir ostras fácilmente con protección para los dedos, acero inoxidable con punta afilada
 pour ouvrir facilement les huîtres avec protection pour les doigts, inox, pointe affûtée

→ cm

88839 14,5



Austernmesser „ORANGE“

oyster knife
 abre ostras
 couteau à huîtres



Edelstahlklinge zum Einstechen in die Schale, mit Fingerschutz

to open oysters easily, with guard
 para abrir ostras fácilmente con protección para los dedos
 pour ouvrir facilement les huîtres avec protection pour les doigts

→ cm

88840 15



Dekoriermesser „ORANGE“

decorating knife „cannelé“
 cuchillo acanalador
 couteau canneléur



gezahnte Klinge aus geschärftem Edelstahl
 serrated sharpened blade, stainless steel
 hoja de sierra afilada, acero inoxidable
 lame inox microdentée

→ cm

88843 19



Käsehobel „ORANGE“

cheese slicer
 rebanador de queso
 couteau tranche-fromage



zum Schneiden von dünnen Käsescheiben

to cut thin slices of cheese
 para cortar lonchas finas de queso
 pour couper de fines tranches de fromage

→ cm

88853 21,5



Streichpalette „BLUE“

spatula
espátula
spatule

flexible Edelstahlklinge, rutschfester Griff, hitzebeständig

flexible blade stainless steel, non-slip handle, heat-resistant

hoja flexible acero inoxidable mango polipropileno termoresistente anti-deslizante

lame inox flexible, manche antiglisse en polypropilène thermorésistant



| | cm | → cm |
|-------|------------|------|
| 88920 | 35 x 5 | 48,5 |
| 88921 | 30,5 x 4,5 | 43,5 |
| 88922 | 25 x 4 | 38,0 |
| 88923 | 20 x 3 | 33,5 |



Winkelpalette „BLUE“

spatula
espátula
spatule

flexible Edelstahlklinge

flexible blade stainless steel

hoja flexible acero inoxidable

lame inox flexible



| | cm | → cm |
|-------|--------|------|
| 88928 | 17 x 5 | 30 |



Gebäckpalette „BLUE“

pastry spatuala
paleta pastelera
spatule pâtissière

flexible Edelstahlklinge

flexible blade stainless steel

hoja flexible acero inoxidable

lame inox flexible



| | cm | → cm |
|-------|----------|------|
| 88932 | 17 x 7,5 | 29,5 |



Wender „BLUE“

turner
espátula
spatule

flexible Edelstahlklinge

flexible blade stainless steel

hoja flexible acero inoxidable

lame inox flexible



| | cm | → cm |
|-------|--------|------|
| 88933 | 15 x 6 | 27,5 |



Winkelpalette „BLUE“

turner
espátula
spatule

flexible Edelstahlklinge
flexible blade stainless steel
hoja flexible acero inoxidable
lame inox flexible



| | cm | → cm |
|-------|----------|------|
| 88935 | 34 x 5 | 47,5 |
| 88937 | 24 x 4 | 36 |
| 88938 | 18,5 x 3 | 32 |



Wender „BLUE“

turner
espátula
spatule

flexible Edelstahlklinge
flexible blade stainless steel
hoja flexible acero inoxidable
lame inox flexible



| | cm | → cm |
|-------|----------|------|
| 88939 | 24 x 7,5 | 37,5 |



Wender „BLUE“

turner
espátula
spatule

perforiert, flexible Edelstahlklinge
perforated, flexible blade stainless steel
hoja flexible inox agujereada
lame ajourée inox flexible



| | cm | → cm |
|-------|------------|------|
| 88940 | 24,5 x 7,5 | 37,5 |



Wender „BLUE“

turner
espátula para plancha
spatule

flexible Edelstahlklinge
flexible blade stainless steel
hoja flexible acero inoxidable
lame inox flexible



| | cm | → cm |
|-------|----------|------|
| 88941 | 20 x 7,5 | 33 |
| 88942 | 15 x 9 | 28 |



Spachtel / Schaber „BLUE“

scraper
 espátula plancha
 spatule coudée spéciale grill
starre Edelstahlklinge
 rigid blade stainless steel
 hoja rígida acero inoxidable
 lame inox rigide



| | cm | → cm |
|-------|---------|------|
| 88929 | 11 x 10 | 25 |



Spachtel / Fettabstecher „BLUE“

scraper
 espátula plancha
 spatule coudée spéciale grill
starre Edelstahlklinge
 rigid blade stainless steel
 hoja rígida de acero inoxidable
 lame rigide inox



| | cm | → cm |
|-------|----------|------|
| 88946 | 17 x 10 | 30 |
| 88947 | 15 x 7,5 | 28 |



Aufstrichmesser „BLUE“

sandwich knife
 cuchillo para untar
 couteau à tartiner
flexible Edelstahlklinge
 flexible blade stainless steel
 hoja flexible acero inoxidable
 lame inox flexible



| | cm | → cm |
|-------|---------|------|
| 88948 | 8,5 x 3 | 18,5 |



Teigschaber / Abstecher „BLUE“

dough scraper
 corta pasta
 coupe-pâte
starre Edelstahlklinge
 rigid blade stainless steel
 hoja rígida de acero inoxidable
 lame rigide inox



| | cm |
|-------|----------|
| 88930 | 15,5 x 8 |



Pizzaschneider „BLUE“

pizza cutter
cortador de pizza
coupe-pizza

ergonomischer Griff
ergonomic handle
mango ergonómico
manche ergonomique



| | Ø cm | → cm |
|-------|------|------|
| 88949 | 10 | 20 |



Eierschneider

egg cutter
corta huevos
coupe-oeufs

zum Längs- und Querteilen von hart gekochten Eiern
to cut hard-boiled eggs
corta a rodajas un huevo duro
en rondelles



| | cm | ↑ cm |
|-------|----------|------|
| 88099 | 14,5 x 8 | 2,5 |



Hummerbrecher

lobster cracker
pinza bogavante
pince à homard



| | cm |
|-------|----------|
| 74201 | 14 x 5,5 |



Schneebeesen

whisk
batidor
fouet



| | Drähte / wires | → cm |
|-------|----------------|------|
| 00744 | 8 | 28 |
| 00745 | 8 | 33 |
| 00746 | 8 | 38 |
| 00747 | 8 | 43 |
| 00740 | 8 | 48 |





Passiersieb

strainer
colador
passoire



feines Siebgewebe mit ca. 6 Löchern pro 1 cm²

fine mesh with 6 holes per 1 cm²

malla fina con 6 agujeros por 1 cm²

toile fine avec 6 trous pour 1 cm²

| | Ø cm | → cm |
|-------|------|------|
| 88618 | 30,0 | 60,0 |
| 88639 | 33,5 | 62,5 |



Passiersieb

strainer
colador
passoire



feines Siebgewebe mit ca. 6 Löchern pro 1 cm²

fine mesh with 6 holes per 1 cm²

malla fina con 6 agujeros por 1 cm²

toile fine avec 6 trous pour 1 cm²

| | Ø cm | → cm |
|-------|------|------|
| 74700 | 14 | 30 |
| 74701 | 16 | 32 |
| 74702 | 18 | 34 |
| 74703 | 20 | 36 |
| 74705 | 24 | 41 |
| 74706 | 26 | 43 |



Passiersieb

strainer
colador
passoire



mit Doppelnetz, Netz außen: ca. 2 Löcher pro 1 cm, Netz innen: ca. 5 Löcher pro 1 cm

with double mesh, outer mesh about 2 holes per cm, inner mesh about 5 holes per cm

con malla doble, malla exterior aprox. 2 agujeros /cm, interior aprox. 5 agujeros /cm

avec double étamine, extérieure env. 2 trous/cm, intérieure environ 5 trous/cm

| | Ø cm | → cm |
|-------|------|------|
| 74721 | 19,5 | 41,0 |
| 74722 | 24,5 | 56,5 |



STRAINERS

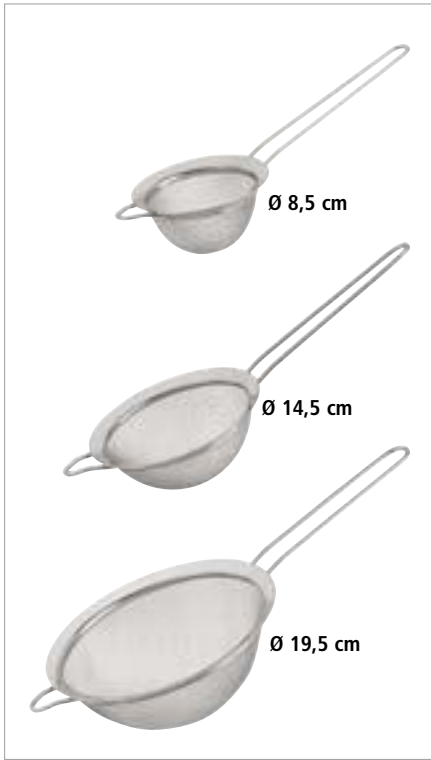

Passiersieb, 3er Set

strainer, 3 pcs.
colador, set de 3
passoire, set de 3



3-teiliges Set bestehend aus 3 Sieben:

Ø 8,5 cm, L: 22,5 cm / Ø 14,5 cm, L: 32 cm / Ø 19,5 cm, L: 38,5 cm

set of 3 consisting of 3 sieves:

Ø 8,5 cm, L: 22,5 cm / Ø 14,5 cm, L: 32 cm / Ø 19,5 cm, L: 38,5 cm

set de 3 que consta de 3 tamices:

Ø 8,5 cm, L: 22,5 cm / Ø 14,5 cm, L: 32 cm / Ø 19,5 cm, L: 38,5 cm

set de 3 composé de 3 tamis :

Ø 8,5 cm, L: 22,5 cm / Ø 14,5 cm, L: 32 cm / Ø 19,5 cm, L: 38,5 cm

| | Ø cm | → cm |
|-------|---------------|--------------|
| 74707 | 8,5/14,5/19,5 | 22,5/33/38,5 |



3 teilig
3 pcs. set



Barsieb

bar strainer
colador de cóctel
tamis cocktail



| | Ø cm | ↑ cm | Griff / handle cm |
|-------|------|------|-------------------|
| 93318 | 8,5 | 5 | 11,5 |



Gazespitzsieb

conical strainer with wire gauze
colador chino de malla
chinois renforcé avec maille fine



hochglanzpoliert, mit rundem Hohlgriff, ca. 9 Löcher pro 1 cm²

mirror polished, 9 holes per 1 cm²

pulido brillante, mango hueco, 9 agujeros por 1 cm²

poli brillant, manche creux, 9 trous pour 1 cm²

| | Ø cm | ↑ cm | Griff / handle cm |
|-------|------|------|-------------------|
| 88717 | 25 | 19 | 24 |



Spitzsieb

conical strainer
colador cónico
chinois



mit Lochung Ø 1,5 mm, auch in der Kegelspitze, mit Flachstiel, mit Stützstiel zum Einhaken in den Topfrand

with Ø 1,5 mm holes (including the tip), with flat handle, with supporting hook

con agujeros finos de Ø 1,5 mm (incluída la punta), con mango plano y gancho

perforations fines 1,5 y compris à la pointe, manche plat et crochet

| | Ø cm | ↑ cm | Griff / handle cm |
|-------|------|------|-------------------|
| 00771 | 23 | 18 | 16,5 |



Seiher
strainer
colador
passoire



| | Ø cm | ↑ cm |
|-------|------|------|
| 74708 | 28,5 | 10 |



Seiher
strainer
colador
passoire



mit 2 Muschelgriffen
with 2 shell shaped grips
con dos asas
à 2 anses moulées

| | Ø cm | ↑ cm |
|-------|------|------|
| 00780 | 36 | 19 |



Pommes-Frites-Seiher
fry dripping tray
escurridor de fritos
égouttoir à friture



herausnehmbarer Locheinsatz, mit Handgriff
removable drainer, with handle
fondo de colador desmontable, con asa
fond démontable, avec poignée

| | Ø cm | ↑ cm |
|-------|------|------|
| 00785 | 39 | 19 |



Salzstreuer
salt shaker
salero
salière



Pommes-Frites Streuer mit Schraubkappe
for french fries, cover to screw
para patatas fritas, tapa de rosca
pour les frites, couvercle à visser

| | Ø cm | ↑ cm | |
|-------|------|------|-----------------|
| 00772 | 8 | 17 | stainless steel |
| 00779 | 8 | 17 | aluminium |



Back- / Frittierlöffel
skimmer / spider
espumadera para fritos
écumoire à friture



elektropoliert, sehr stabile Ausführung
electro polished, heavy gauge
electro pulido, alta calidad
poli électrolythique, qualité extra

| | Ø cm | → cm |
|-------|------|------|
| 74402 | 16 | 48 |
| 74404 | 20 | 54 |



Wasserbadschüssel
 bain marie bailing bowl
 cazo para baño maría
 récipient bain-marie



hochglanzpoliert, mit Drahtgriff Ø 5 mm
 mirror polished, with wire handle Ø 5 mm
 pulido brillante, mango varilla Ø 5 mm
 poli brillant, manche fil épaisseur Ø 5 mm

| | Ø cm | ↑ cm | Griff / handle cm | litr. |
|-------|------|------|-------------------|-------|
| 74731 | 18 | 9 | 15 | 1,5 |



Anwendungsbeispiel, Topf ≥ 20 cm
 Application Example, pot ≥ 20 cm



Saucen- und Fondantrichter
 sauce and confectionery funnel
 embudo para salsa y confitería
 entonnoir à sauce et confiserie



ergonomischer Griff, Maßskalierung innen, mit 3 Düsen Ø 4, 5, 6 mm, inklusive Ständer und Auffangschale

ergonomic handle, scaling inside, with 3 different nozzles Ø 4, 5, 6 mm, including wire rack a. dripping dash
 mango ergonómico, escalado interior, con 3 boquillas, Ø 4, 5, 6 mm, incl. pie de alambre y bandeja recoge gotas
 manche ergonomique, mise à l'échelle à l'intérieur, 3 douilles de Ø 4, 5 et 6 mm, inclut pied avec ramasse-gouttes

| | Ø cm | ↑ cm | litr. |
|-------|------|------|-------|
| 77338 | 21 | 31,5 | 1,5 |



Anwendungsbeispiel
 application example



Maßskalierung innen
 scaling inside



Gemüsehobel, Mandoline
 mandolin
 mandolina
 mandoline



mit 7 verschiedenen Klingen (Breite 10 cm), Anti-Rutsch-Gestell, Schutzabdeckung
 with 7 interchangeable blades (width 10 cm), non-slip folding stand, safety guard
 con 7 cuchillas intercambiables (corte 10 cm), pie plegable anti-deslizante, carro de seguridad
 7 peignes interchangeables (largeur 10 cm), pied repliable anti-glisse, chariot

| | cm | ↑ cm |
|-------|-----------|--------|
| 88688 | 40,5 x 12 | 5 / 25 |



A 7 verschiedene Klingen
 7 interchangeable blades
B Praktische Transportbox
 Practical transport box



Messbecher
graduated jug
jarra graduada
pichet gradué



außen hochglanzpoliert, innen matt poliert, mit Maßskalierung außen
outside mirror polished, inside matt polished, with stamped liter scale
exterior pulido brillante, interior pulido mate con escalado en litros
extérieur poli brillant, intérieur poli mat, graduation en litres

| | Ø cm | ↑ cm | ltr. |
|-------|------|------|------|
| 30045 | 10 | 14 | 1 |

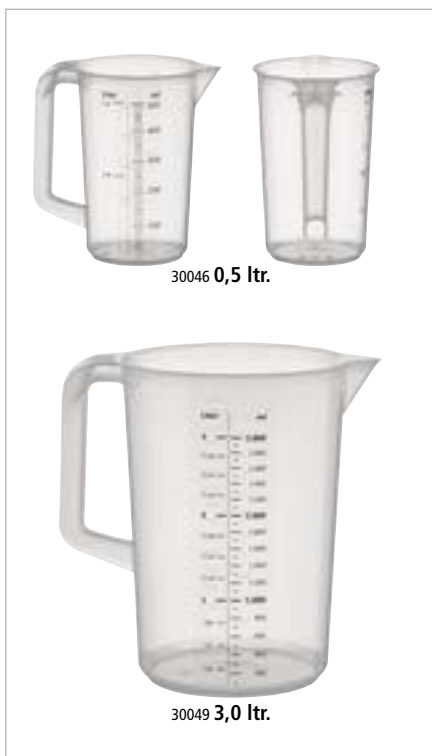

Messbecher „PRO“
measuring cup
jarra graduada
pichet gradué



mit geschlossenem Griff, mit geprägter Maßskalierung außen, l- und ml-Liter-Einteilung
with closed handle, with stamped printed liter and ml scale
con asa cerrada, con escala estampada de litros y ml
avec poignée fermée, avec échelle en litres et ml imprimée et tamponnée

| | Ø cm | ↑ cm | ltr. |
|-------|------|------|------|
| 30046 | 9 | 14 | 0,5 |
| 30047 | 12 | 16,5 | 1,0 |
| 30048 | 15 | 20,5 | 2,0 |
| 30049 | 17 | 23,5 | 3,0 |
| 30057 | 20 | 25,5 | 5,0 |



einfaches Eingießen
easy pouring



Messbecher „STACKABLE“
measuring cup
jarra graduada
pichet gradué



mit offenem Griff und geprägter Maßskalierung außen, platzsparend stapelbar
with open handle and embossed dimension scaling on the outside, space-saving stackable
con asa abierta y escala de dimensiones en relieve en el exterior, apilable para ahorrar espacio
avec une poignée ouverte et une échelle de dimensions en relief à l'extérieur, empilable et peu encombrante

| | Ø cm | ↑ cm | ltr. |
|-------|------|------|------|
| 30059 | 7 | 12 | 0,25 |
| 30061 | 9 | 14 | 0,5 |
| 30062 | 12 | 16,5 | 1,0 |
| 30063 | 15 | 20,5 | 2,0 |



offener Griff
open handle

einfaches Eingießen
easy pouring

stapelbar
stackable



1 ltr.

inkl. Spritzschutz / incl. splash guard

Rührbecher mit Deckel

stirring cup with lid
vaso agitador con tapa
tasse à remuer avec couvercle



inklusive Spritzschutz und geprägter Maßskalierung außen, platzsparend stapelbar

included splash guard with open handle and embossed dimension scaling on the outside, space-saving stackable

protección contra salpicaduras incluida con asa abierta y escala de dimensiones en relieve en el exterior, apilable para ahorrar espacio

protection contre les éclaboussures incluse avec une poignée ouverte et une échelle de dimensions en relief à l'extérieur, empilable et peu encombrante

| | Ø cm | ↑ cm | ltr. |
|-------|------|------|------|
| 30058 | 12,5 | 16 | 1,0 |



Griff mit Daumenmulde
handle with thumb recess



mit Silikonring
with silicone ring



Schaumspeisering

mousse ring
aro redondo para semifríos
cercle à mousse rond

matt poliert, fugenlos
matt polished, seamless
pulido mate, sin soldadura
poli mat, sans soudure



| | Ø cm | ↑ cm |
|-------|------|------|
| 00098 | 6 | 4,5 |
| 00099 | 7 | 4,5 |
| 00092 | 8 | 4,5 |
| 00093 | 10 | 4,5 |
| 00094 | 12 | 4,5 |



00110

Schaumspeiseringe, 5er Set

mousse ring, 5 pcs.
juego aros para emplatar o para semifríos
jeu de cercles à mousse inox, ronds

5-teilig: 4 Formen + 1 Verdichter, matt poliert, fugenlos

5 pcs. set: 4 shapes and 1 pusher, matt polished, seamless

juego de 5 piezas: 4 aros redondos y 1 pulsador, para dar forma, satinado sin soldadura

jeu de 5 pièces: 4 cercles et 1 poussoir. Idéal pour dressage sur assiette ou mousse, poli mat, sans soudure



| | Ø cm | ↑ cm | pcs. |
|-------|------|------|------|
| 00110 | 6 | 4,5 | 5 |
| 00113 | 8 | 4,5 | 5 |



Dariolformen, 2er Set

dariol moulds, 2 pcs.
juego 2 flaneras
jeu de 2 moules à flan

hochglanzpoliert
mirror polished
pulido brillante
poli brillant



| | Ø cm | ↑ cm | ltr. | pcs. |
|-------|------|------|------|------|
| 00106 | 6,5 | 4,5 | 0,1 | 2 |



Tortenring

cake setting ring
aro de tarta
cercle à gâteaux

stufenlos verstellbar, ohne Griff
adjustable, without handle
ajustables, sin asa
ajustables, sans poignée



| | Ø cm | ↑ cm |
|-------|-----------|------|
| 00040 | 16,5 - 32 | 7 |



Anwendungsbeispiel
application example



Backform

baking pan
marco pastelero
forme à gateaux

stufenlos verstellbar, aus flexiblem Edelstahl
adjustable, made of flexible stainless steel
ajustable, de acero inoxidable flexible
ajustable, en acier inox flexible



| | cm | ↑ cm |
|-------|-------------------|------|
| 00042 | 19 x 28 - 34 x 54 | 5 |



Anwendungsbeispiel
application example



Ausstellblech / Thekenblech

display tray
bandeja pastelera
plaque pâtissière

hitzebeständig bis 230°C
heat-resistant up to 230°C
resistente al calor hasta 230 °C
résistant à la chaleur jusqu'à 230°C



| | cm | ↑ cm |
|-------|---------|------|
| 13377 | 40 x 25 | 2 |
| 13378 | 48 x 32 | 2 |
| 13379 | 60 x 40 | 2 |



Profi-Eimer

bucket
cubo
seau



mit Ausgießer und geprägter Maßskalierung innen
with spout and embossed dimension scaling inside
con pico y escala de medición en relieve en el interior
avec bec verseur et échelle de mesure en relief à l'intérieur

| | Ø cm | ↑ cm | ltr. | Farbe / Colour |
|-------|------|------|------|----------------|
| 30075 | 28,5 | 28,5 | 10,5 | White |
| 30076 | 33,0 | 32,0 | 17,0 | White |
| 30077 | 28,5 | 28,5 | 10,5 | Black |
| 30078 | 33,0 | 32,0 | 17,0 | Black |



mit Griff
with handle



Maßskalierung innen
dimension scaling inside



Auslaufnase für sicheres Handling
discharge nose for safe handling



Mehlschaufel „PRO“

scoop
pala
pelle à farine



stehende Schaufel, auch für Flüssigkeiten geeignet
standing scoop, also applicable for liquids
pala, ápto también para líquidos
adaptée pour poudres et liquides

| | cm | ↑ cm | ltr. | Farbe / Colour |
|-------|---------|------|------|----------------|
| 00610 | 25 x 9 | 4,5 | 0,25 | White |
| 00611 | 31 x 12 | 5,5 | 0,5 | White |
| 00612 | 35 x 13 | 6 | 0,7 | White |



Schaufel „ECO“

scoop
pala
pelle



stabil und bruchsicher
stable and unbreakable
estable e irrompible
stable et incassable

| | → cm | ltr. |
|-------|------|-------|
| 00694 | 18 | 0,110 |
| 00695 | 24 | 0,230 |
| 00696 | 31 | 0,470 |
| 00697 | 33 | 0,725 |



Zum schnellen und zielgerichteten Abfüllen von Lebensmitteln
for fast and targeted filling of foodstuffs



30065 Ø 6 cm

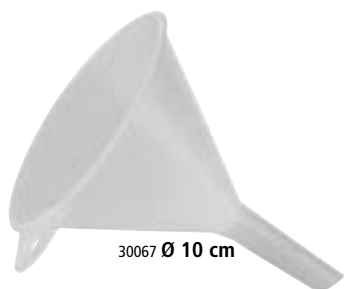

30067 Ø 10 cm



30068 Ø 12 cm



mit Sieb
with strainer

30070 Ø 17 cm



mit Sieb
with strainer

30071 Ø 21 cm

Trichter „PROFI“

funnel
embudo
entonnoir

mit Öse
with eyelet
con ojal
avec œillet



| | Ø cm | Ø mm Durchlass | |
|-------|------|----------------|--------------------------|
| 30065 | 6 | 8 | |
| 30066 | 8 | 11 | |
| 30067 | 10 | 12 | |
| 30068 | 12 | 12 | |
| 30069 | 14 | 15 | |
| 30070 | 17 | 17 | mit Sieb / with strainer |
| 30071 | 21 | 20 | mit Sieb / with strainer |



erleichtert das Einfüllen
facilitates filling



Anwendungsmöglichkeit
applicability



mit einsetzbarem Sieb
with insertable strainer



mit einsetzbarem Sieb
with insertable strainer



Limetten- / Zitronenpresse

lime- / lemonpress
 exprimidor de limón / lima
 presse citron

2 Pressringe für Zitrone und Limette

2 squeezing rings for lemon and lime
 2 anillos exprimidores para limón y lima
 2 anneaux à presser pour le citron et le lime



| | | |
|-------|--------|------|
| | cm | ↑ cm |
| 93214 | 21 x 7 | 5 |



Limettenpresse

lime press
 prensa de limón
 presse citron

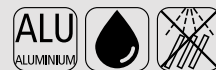

| | | |
|-------|--------|------|
| | cm | ↑ cm |
| 93189 | 21 x 7 | 5 |



Zitruspresse

citrus squeezer
 exprimidor cítricos
 presse-citron

hochglanzpoliert, 2-teilig

mirror polished, 2 pcs.
 pulido brillante, 2 piezas
 poli brillant, 2 pièces



| | | | |
|-------|---------|------|------|
| | Ø cm | ↑ cm | ltr. |
| 71431 | 12 / 17 | 10,5 | 0,35 |



Pinsel

brush
 brocha
 pinceau pâtissier

weißgebleichte, naphthalinfreie Borsten, temperaturbeständig von -40°C bis +95°C

bleached bristles, heat-resistant from -40°C to +95°C
 cerdas blanqueadas, resistencia térmica -40°C hasta +95°C
 soies blanchies sans naphthaline, résistance de -40°C à +95°C



| | | |
|-------|-------|------|
| | cm | → cm |
| 77350 | 4 x 1 | 23,5 |



Panierstation, 3-teilig

breading set, 3 pcs. set
 estación de empanado, set de 3
 station de panure, set de 3

zum Panieren von Fleisch, Gemüse, Käse etc.

for breading meat, vegetables, cheese etc.
 para empanar carne, verduras, queso, etc.
 pour paner la viande, les légumes, le fromage etc.



| | | |
|-------|-----------|------|
| | cm | ↑ cm |
| 66904 | 45,5 x 18 | 2,5 |





Bonspieß
bill spike
pinchanotas
pique-bons



Spieße aus flexiblem Kunststoff, mit stumpfen Enden zur Unfallverhütung
spikes made of flexible plastic, with blunt ends to prevent accidents
pinchos de plástico flexible
piques en plastique flexible

| | cm | ↑ cm |
|-------|---------|------|
| 88855 | 9 x 5,5 | 10,5 |



Bonleiste
bill rail
portafichas
barre porte-bons



matt poliert, mit Kugel-Greifsystem, zur Wandmontage geeignet, auch mit Magneten nutzbar
matt polished, small balls hold the bills, suited for wall fastening, can also be used with magnets
pulido mate, con sistema de bolas para colgar las notas para fijar en la pared, puede usarse con imán
poli mat, avec billes pour fixer sans effort tous types de fiches et papiers, peut se fixer sur plaque aimantée

| | cm | ↑ cm |
|-------|--------|------|
| 88900 | 40 x 8 | 2 |
| 88901 | 50 x 8 | 2 |
| 88902 | 60 x 8 | 2 |



Magnet-Messerhalter
magnetic knife rack
barra magnética para cuchillos
barre aimantée pour couteaux



mit 2 Magnetschienen und Haken, aus massivem Kunststoff, zur Wandmontage geeignet, Lieferung ohne Deko
with 2 magnet racks and hooks, strong plastic, suited for wall fastening
con 2 railes magnéticos y ganchos, plástico macizo, fijación en pared
avec 2 rails aimantés et crochets, plastique robuste, fixation murale

| | → cm |
|-------|------|
| 88911 | 45 |
| 88912 | 60 |



Folien-Abreißvorrichtung
clingfilm tear-off-dispenser
dispensador de film
dérouleur de film



mit Abreißkante / Säge-Messer, für Endlosfolie, als Tischgerät oder Wandgerät verwendbar
with saw, for endless rolls, can be fixed on the wall
con sierra para rollo de film continuo, se puede fijar en la pared
avec lame dentée pour rouleau de film, peut être fixé au mur

| | cm | ↑ cm | |
|-------|---------|------|--|
| 88288 | 34 x 16 | 9 | für Folienbreite 30 cm / for film width 30 cm para film ancho 30 cm / pour film largeur 30 cm |
| 88287 | 49 x 16 | 9 | für Folienbreite 45 cm / for film width 45 cm para film ancho 45 cm / pour film largeur 45 cm |



Schneidbrettständer

cutting board rack
soporte para tablas
rack pour planches à découper

für 6 Schneidbretter bis 25 mm Stärke, Lieferung ohne Deko
for 6 chopping boards up to 25 mm thickness
para 6 tablas de corte de 25 mm
pour 6 planches de 25 mm



| | | |
|-------|---------|------|
| | cm | ↑ cm |
| 88903 | 27 x 31 | 28 |



Eiswaffel-Ständer

cornet stand
soporte cucuruchos
support à cornets

matt poliert, mit 4 Löchern, 2 x Ø 31 mm + 2 x Ø 26 mm
matt polished, with 4 holes, 2 x Ø 31 mm + 2 x Ø 26 mm
pulido mate, con 4 agujeros 2 x Ø 31 mm + 2 x Ø 26 mm
poli mat, 4 trous - 2 x Ø 31 mm + 2 x Ø 26 mm



| | | |
|-------|------------|------|
| | cm | ↑ cm |
| 11881 | 27,5 x 9,5 | 9 |



Eisportionierer

ice cream scoop
cuchara para helado
cuillère à glace

hochglanzpoliert, mit Edelstahlfeder (physikalisch bedingt nicht korrosionsbeständig)
mirror polished, spring steel, spring is not stainless
pulido brillante, muelle de acero especial, no resistente al óxido
poli brillant, ressort acier spécial, non résistant à l'oxydation



| | Ø cm | → cm | ltr. |
|-------|------|------|------|
| 71006 | 6,5 | 23,5 | 1/12 |
| 71005 | 6,0 | 22,5 | 1/16 |
| 71004 | 5,5 | 22,0 | 1/20 |
| 71003 | 5,0 | 22,0 | 1/24 |
| 71002 | 5,0 | 21,5 | 1/30 |
| 71001 | 4,5 | 21,0 | 1/36 |

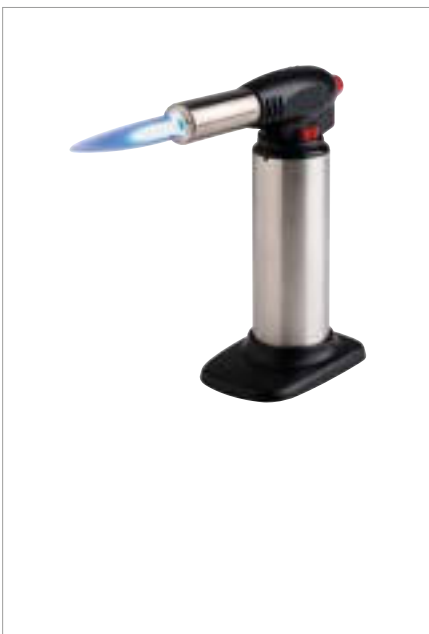

Flambierbrenner

chefs blow torch
soplete de cocina para flambear
chalumeau de cuisine

mit handelsüblichem Feuerzeuggas auffüllbar, Flamme einstellbar bis ca. 1300° C, Brenndauer von mindestens 60 Minuten

to be filled with commercial lighter gas, flame adjustable up to approx. 1300° C, burning time of at least 60 minutes

rellenable con gas de mechero comercial, llama ajustable hasta 1300 ° C, tiempo de combustión de al menos 60 minutos

rempli avec gaz pour briquet commercial, flamme réglable jusqu'à 1300 ° C, temps de combustion d'au moins 60 minutes



| | | |
|-------|------|------|
| | Ø cm | ↑ cm |
| 77315 | 4,5 | 16,5 |



Anwendungsbeispiel
application example

SQUEEZE BOTTLES



Quetschflasche

squeeze bottle
bote dosificador flexible
bouteille verseuse souple



mit Schraubdeckel und Verschlusskappe, ideal für Dressing und Saucen

with tight-screw and cap, ideal for dressing and sauce

con tapa de rosca y tapón, ideal para aliño y salsas

avec couvercle à visser et bouchon de fermeture, idéal pour vinaigrette et sauces

| | Ø cm | ↑ cm | ltr. | Farbe / Colour |
|-------|------|------|-------|----------------|
| 93259 | 8 | 26,5 | 1,025 | White |
| 93260 | 8 | 26,5 | 1,025 | Yellow |
| 93261 | 8 | 26,5 | 1,025 | Red |



große „Öffnung“
big „mouth opening“



Quetschflasche

squeeze bottle
bote dosificador flexible
bouteille verseuse souple



mit Schraubdeckel und Verschlusskappe, ideal für Dressing und Saucen

with tight-screw and cap, ideal for dressing and sauce

con tapa de rosca y tapón, ideal para aliño y salsas

avec couvercle à visser et bouchon de fermeture, idéal pour vinaigrette et sauces

| | Ø cm | ↑ cm | ltr. | Farbe / Colour |
|-------|------|------|------|----------------|
| 93155 | 6,5 | 24 | 0,65 | Yellow |
| 93156 | 6,5 | 24 | 0,65 | Red |
| 93157 | 6,5 | 24 | 0,65 | White |



Quetschflasche „MINI“, 4er Set

squeeze bottle, 4 pcs.
bote dosificador flexible, 4 pz.
bouteille verseuse souple, 4 pc.



mit Schraubdeckel und Verschlusskappe, ideal für Dressing und Saucen

with tight-screw and cap, ideal for dressing and sauce

con tapa de rosca y tapón, ideal para aliño y salsas

avec couvercle à visser et bouchon de fermeture, idéal pour vinaigrette et sauces

| | Ø cm | ↑ cm | ltr. | pcs. |
|-------|------|------|------|------|
| 93225 | 3,0 | 8,5 | 0,03 | 4 |
| 93226 | 3,5 | 9,5 | 0,05 | 4 |

SQUEEZE BOTTLES



Quetschflasche, 6er Set

squeeze bottle, 6 pcs.
bote dosificador flexible, set de 6
bouteille verseuse souple, set de 6



mit Schraubdeckel und Verschlusskappe, ideal für Dressing und Saucen

with tight-screw and cap, ideal for dressing and sauce

con tapa de rosca y tapón, ideal para aliño y salsas

avec couvercle à visser et bouchon de fermeture, idéal pour vinaigrette et sauces

| | Ø cm | ↑ cm | ltr. | Farbe / Colour | pcs. |
|-------|------|------|------|----------------|------|
| 93250 | 5 | 18,0 | 0,26 | White | 6 |
| 93251 | 5 | 18,0 | 0,26 | Yellow | 6 |
| 93252 | 5 | 18,0 | 0,26 | Red | 6 |
| 93253 | 7 | 20,0 | 0,49 | White | 6 |
| 93254 | 7 | 20,0 | 0,49 | Yellow | 6 |
| 93255 | 7 | 20,0 | 0,49 | Red | 6 |
| 93256 | 7 | 26,5 | 0,76 | White | 6 |
| 93257 | 7 | 26,5 | 0,76 | Yellow | 6 |
| 93258 | 7 | 26,5 | 0,76 | Red | 6 |



mit Verschlusskappe
with cap



große „Öffnung“
big „mouth opening“



Quetschflasche „NON DRIP“

squeeze bottle
bote dosificador flexible
bouteille verseuse souple



mit Schraubdeckel und Verschlusskappe, ideal für Dressing und Saucen

with tight-screw and cap, ideal for dressing and sauce

con tapa de rosca y tapón, ideal para aliño y salsas

avec couvercle à visser et bouchon de fermeture, idéal pour vinaigrette et sauces

| | Ø cm | ↑ cm | ltr. | Farbe / Colour |
|-------|------|------|------|----------------|
| 93270 | 5,5 | 21,0 | 0,35 | White |
| 93271 | 5,5 | 21,0 | 0,35 | Yellow |
| 93272 | 5,5 | 21,0 | 0,35 | Red |
| 93273 | 7,0 | 25,5 | 0,75 | White |
| 93274 | 7,0 | 25,5 | 0,75 | Yellow |
| 93275 | 7,0 | 25,5 | 0,75 | Red |



mit Skalierung
with scaling



tropffrei
non drip



Quetschflasche

squeeze bottle
bote dosificador flexible
bouteille verseuse souple



ideale Größe, um Speiseteller mit Saucen zu verzieren, mit Verschlusskappe

ideal size to garnish plates with sauces, with cap

tamaño ideal para decorar platos con salsas, con tapón

taille idéale pour décorer assiettes avec des sauces, avec bouchon

| | Ø cm | ↑ cm | ltr. |
|-------|------|------|------|
| 93154 | 5 | 16 | 0,2 |
| 93163 | 6 | 21 | 0,35 |



Dosierspender

dispenser
dispensador de salsa
doseur à sauce



| | cm | ↑ cm | ltr. | GN |
|-------|-------------|------|------|-----|
| 93280 | 17,6 X 16,2 | 27 | 2,6 | 1/6 |

Dosierpumpe, Hubvolumen 30 ml

dosing pump / riser tube, swept volume 30 ml
bomba de salsa, sola, cada dosis 30 ml
pompe à sauce, 30 ml par dose



| | cm | ↑ cm | ltr. | |
|-------|------------|------|------|---------------|
| 93281 | 12,5 X 4,5 | 26 | 0,30 | fits to 93280 |



Dosierpumpe

dosing pump / riser tube
bomba de salsa, sola
pompe à sauce



Hubvolumen 30 ml
swept volume 30 ml
cada dosis 30 ml
30 ml par dose

| | Ø cm | ↑ cm |
|-------|------|------|
| 88271 | 4,5 | 40 |



Eier-Box

eggs box
caja para huevos
boîte à oeufs



mit luftdichtem Deckel, für 4 Lagen à 30 Eier, Lieferung inkl. 8 Lagen, Größe Lage: 28 x 28 cm
with airtight cover, capacity: 4 trays of 30 eggs, delivery with 8 trays, size of tray: 28 x 28 cm
capacidad para 4 bandejas de 30 huevos, tapa hermética, se entrega con 8 bandejas, formato bandejas 28 x 28 cm, apto para lavavajillas
pour 4 plateaux de 30 oeufs chacun, apte pour 4 plateaux plats, couvercle hermétique, livré avec 8 plateaux, dimension plateau 28x28 cm, lavable en lave-vaisselle

| | cm | ↑ cm | GN |
|-------|-------------|------|-----|
| 82419 | 35,4 x 32,5 | 20 | 2/3 |



Aufsteller „ACHTUNG RUTSCHGEFAHR“

stand
letrero
panneau



| | cm | ↑ cm | Farbe / Colour |
|-------|---------|------|----------------|
| 71421 | 30 x 63 | 63 | |

Pizzaform



9 sizes



Pizzaform

pizza dish
molde de pizza
moule à pizza



Blaublech, nicht beschichtet, lange Lebensdauer, hitzebeständig bis 360 °C
metal sheet, without coating, long endurance, heat resistant up to 360 °C
chapa azul, sin revestimiento, larga vida útil, resistente al calor hasta 360 °C
métal, sans revêtement, longue durée de vie, à la chaleur jusqu'à 360 °C

| | ∅ cm | ↑ cm |
|-------|---------|------|
| 73502 | 16 - 18 | 2,5 |
| 73505 | 22 - 24 | 2,5 |
| 73506 | 24 - 26 | 2,5 |
| 73507 | 26 - 28 | 2,5 |
| 73508 | 28 - 30 | 2,5 |
| 73509 | 30 - 32 | 2,5 |
| 73510 | 34 - 36 | 2,5 |
| 73511 | 38 - 40 | 2,5 |
| 73513 | 48 - 50 | 3,0 |



stapelbar
stackable



Backhandschuhe

baking mittens
manoplas de panadero
gants de boulanger

Leder, gefüttert, Einheitsgröße, mit Stulpen, extrem hitzebeständig bis 250°C
leather, inner lining, one size, with cuffs, extremely heat resistant up to 250°C
cuero interior forrado, talla única, resiste a temperaturas hasta 250°C
cuir intérieur doublé, taille unique, résiste à maxi 250°C

| | → cm |
|-------|------|
| 88090 | 45 |



Gestell für Pizzaformen

rack for pizza pans
rejilla para pizzas
support pour moules à pizza



Edelstahlgestell zusammenklappbar für Pizzaformen Ø 28 cm, Abstand zwischen den Ebenen 5,5 cm

foldable stainless steel rack for pizza dishes ø 28 cm, distance between the levels 5.5 cm
rejilla plegable de acero inoxidable para moldes de pizza de Ø 28 cm, distancia entre los niveles 5,5 cm
support en acier inox pliable pour les moules à pizza de Ø 28 cm, distance entre les niveaux 5,5 cm

| | cm | ↑ cm |
|-------|---------|------|
| 73515 | 26 x 25 | 26 |



Backofen geeignet
suitable for oven

Pizzaform für Ø 28 cm
pizza dish for Ø 28 cm

Pizzaform
pizza dish
molde de pizza
moule à pizza

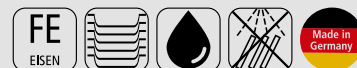

| | Ø cm | ↑ cm | mm |
|-------|---------|------|----|
| 73507 | 26 / 28 | 2,5 | 1 |



Pizzaschaufel
pizza peel
pala de pizza
pelle à pizza



| | cm | → cm |
|-------|-----------|------|
| 88080 | 35 x 30,5 | 90 |
| 88081 | 35 x 30,5 | 130 |

PIZZA



Teig- und Pizzaballenbehälter
 dough and pizza ball container
 recipiente para masa y bolas de pizza
 récipient à pâte et boules à pizza



Innenmaß 56,5 x 36,5 cm, H: 6,5 cm
 inner dimension 56,5 x 36,5 cm, H: 6,5 cm
 medida interior 56,5 x 36,5 cm, H: 6,5 cm
 dimension intérieure 56,5 x 36,5 cm, H: 6,5 cm

| | cm | ↑ cm | ltr. |
|-------|---------|------|------|
| 82440 | 60 x 40 | 7 | 13 |



stapelbar
 stackable

passender Deckel / fitting lid / tapa adecuada / couvercle approprié

| | cm | ↑ cm |
|-------|---------|------|
| 82441 | 60 x 40 | 1 |



Pizzaform
 pizza dish
 molde de pizza
 moule à pizza



Blaublech, rechteckig, Rand umgelegt, hitzebeständig bis 360 °C
 blue steel baking sheet, rectangular, heat resistant up to 360 °C
 chapa azul rectangular, borde plagado, resistente al calor hasta 360 °C
 métal, rectangulaire, bord plié, à la chaleur jusqu'à 360 °C

| | cm | ↑ cm |
|-------|---------|------|
| 88256 | 60 x 40 | 2,5 |



Pizzaschneider „BLUE“
 pizza cutter
 cortador de pizza
 coupe-pizza



ergonomischer Griff
 ergonomic handle
 mango ergonómico
 manche ergonomique

| | Ø cm | → cm |
|-------|------|------|
| 88949 | 10 | 20 |



Teigschaber / Abstecher „BLUE“
 dough scraper
 corta pasta
 coupe-pâte



starre Edelstahlklinge
 rigid blade stainless steel
 hoja rígida de acero inoxidable
 lame rigide inox

| | cm |
|-------|----------|
| 88930 | 15,5 x 8 |

**Mehlschaufel „PRO“**

scoop
pala
pelle à farine

stehende Schaufel, auch für Flüssigkeiten geeignet

standing scoop, also applicable for liquids

pala, ápto también para líquidos

adaptée pour poudres et liquides



| | cm | ↑ cm | ltr. | Farbe / Colour |
|-------|---------|------|------|----------------|
| 00610 | 25 x 9 | 4,5 | 0,25 | White |
| 00611 | 31 x 12 | 5,5 | 0,5 | White |
| 00612 | 35 x 13 | 6 | 0,7 | White |

**Saucengießlöffel „CLASSIC“**

sauce / gravy ladle
cucharón de salsa
cuillère à sauce

hochglanzpoliert, ergonomisch profilierter Hohl-Griff, fugenlos

mirror polished, ergonomic designed handle, seamless

pulido brillante, asa ergonómica, sin soldadura

poli brillant, manche ergonomique, monobloc (sans soudure)



| | cm | Griff / handle cm | ltr. |
|-------|---------|-------------------|------|
| 75906 | 7 x 5,5 | 22 | 0,02 |

**Pinsel**

brush
brocha
pinceau pâtissier

weißgebleichte, naphtalinfreie Borsten, temperaturbeständig von -40°C bis +95°C

bleached bristles, heat-resistant from -40°C to +95°C

cerdas blanqueadas, resistencia térmica -40°C hasta +95°C

soies blanchies sans naphtaline, résistance de - 40°C à + 95°C



| | cm | → cm |
|-------|-------|------|
| 77350 | 4 x 1 | 23,5 |

**Schüssel**

bowl
ensaladera
saladier
glasklar

crystal clear

cristalina

transparent



| | Ø cm | ↑ cm | ltr. | Farbe / Colour |
|-------|------|------|------|----------------|
| 30260 | 32,5 | 10 | 4 | White |
| 30263 | 40 | 12 | 8 | White |

**Korkuntersetzer**

cork mat
salvamanteles
dessous-de-plat liège

ideal für Servier- und Eisenpfannen

ideal for iron pan

ideal para servir en sartenes de chapa

idéal pour présenter les poêles forgées sur table



| | Ø cm | ↑ cm |
|-------|------|------|
| 73750 | 24 | 2 |





Hauben & Zubehör

covers & accessories
campanas & accesorios
cloches & accessoires

| | |
|------------------------|-----|
| GN COVERS..... | 484 |
| GN ROLLTOP COVERS..... | 487 |
| ROLLTOP COVERS..... | 488 |
| SUPER DOME..... | 489 |
| PLATE COVERS..... | 490 |
| COVERS..... | 491 |
| LIDS..... | 493 |
| COOLERS..... | 496 |
| TO GO CUP..... | 497 |

QUALITÄTSHAUBEN

11042
GN 1/1

11041
GN 1/2



11043 GN 1/3



11044 GN 2/4



11041 GN 1/2



11042 GN 1/1

GN Abdeckhaube

GN cover
GN cubierta
GN cloche



passend für GN Tablett, glasklarer Kunststoff, nahezu bruchfest

suitable for GN trays, clear plastic, nearly unbreakable

apto para bandejas GN, plástico transparente, muy resistente a la rotura

pour bacs et plateaux GN, plastique transparent, très résistant à la casse

| | cm | ↑ cm | * mm | GN |
|-------|-------------|------|------|-----|
| 11043 | 32,5 x 17,6 | 10,5 | 3 | 1/3 |
| 11044 | 53,0 x 16,2 | 10,5 | 3 | 2/4 |

| | cm | ↑ cm | * mm | GN |
|-------|-------------|------|------|-----|
| 11041 | 32,5 x 26,5 | 9,5 | 3 | 1/2 |
| 11042 | 53,0 x 32,5 | 9,5 | 3 | 1/1 |



stapelbar
stackable



GN 1/1 Haube „HOCHSTAPLER“

GN 1/1 cover
GN 1/1 campana
GN 1/1 cloche



glasklarer Kunststoff, Tablett fixiert sich auf der Haube - kein Rutschen möglich, nahezu bruchfest

clear plastic, tray fixes itself on the cover and can not slip off, nearly unbreakable

plástico transparente, la bandeja se fija a la tapa para que no se deslice, muy resistente a la rotura

en plastique transparent, le plat se fixe sur le dessous de la cloche pour ne pas glisser, très résistant à la casse

| | cm | ↑ cm | GN | fits to |
|-------|-----------|------|-----|---------------------|
| 11305 | 53 x 32,5 | 9 | 1/1 | 11300, 11290, 11295 |



GN Kuppelhaube

GN cover
GN cúpula
GN cloche bombée

glasklarer Kunststoff, Griff aus Zinkdruckguss

crystal clear plastic, die-cast zinc knob

plástico transparente, asa de zinc fundido a presión

plastique transparente, poignée en zinc moulé sous pression

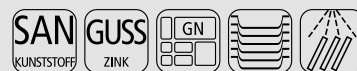

| | cm | ↑ cm | GN | |
|-------|---------|------|-----|--|
| 11021 | 33 x 28 | 17 | 1/2 | geschlossen / totally closed cerrada / toalemt fermée |
| 11022 | 33 x 28 | 17 | 1/2 | mit Front-Ausschnitt / one long side cut out gran apertura frontal grande ouverture frontale |
| 11026 | 54 x 33 | 20 | 1/1 | geschlossen / totally closed cerrada / toalemt fermée |
| 11027 | 54 x 33 | 20 | 1/1 | mit Front-Ausschnitt / one long side cut out gran apertura frontal grande ouverture frontale |
| 11028 | 54 x 33 | 20 | 1/1 | mit seitlichem Ausschnitt one small side cut out pequeña apertura lateral petite ouverture latérale |





GN Kuppelhaube

GN cover
GN cúpula
GN cloche bombée



glasklarer Kunststoff, Griff aus Zinkdruckguss

crystal clear plastic, die-cast zinc knob

plástico transparente, asa de zinc fundido a presión

plastique transparente, poignée en zinc moulé sous pression

| | cm | ↑ cm | GN | |
|-------|---------|------|-----|--|
| 11070 | 54 x 33 | 20 | 1/1 | geschlossen / totally closed cerrada / totalmente fermée |
| 11071 | 54 x 33 | 20 | 1/1 | mit Front-Ausschnitt / one long side cut out gran apertura frontal grande ouverture frontale |
| 11072 | 54 x 33 | 20 | 1/1 | mit seitlichem Ausschnitt one small side cut out pequeña apertura lateral petite ouverture latérale |
| 11073 | 33 x 28 | 17 | 1/2 | geschlossen / totally closed cerrada / totalmente fermée |
| 11074 | 33 x 28 | 17 | 1/2 | mit Front-Ausschnitt / one long side cut out gran apertura frontal grande ouverture frontale |



GN 1/1 Haube

GN 1/1 cover
GN 1/1 campana
GN 1/1 cloche



klappbar, passend für GN 1/1-Behälter, GN 1/1-Tabletts, etc., nahezu bruchfest

suitable for GN 1/1 chafing dish, GN 1/1 trays, GN 1/1 pans

plegable, para cubetas GN 1/1, bandejas GN 1/1 etc., muy resistente a la rotura

pliable, pour bacs GN 1/1, plateaux GN 1/1 etc., très résistant à la casse

| | cm | ↑ cm | GN |
|-------|-------------|------|-----|
| 11013 | 53,0 x 32,5 | 6 | 1/1 |



klappbar
adjustable



GN 1/1 Rolltophaube

GN 1/1 rolltop cover
GN 1/1 campana rolltop
GN 1/1 cloche rolltop



patentiert, passend für GN-Behälter, -Tablets, etc., leichtgängig auf- und zuklappbar 90°
patented, suitable for GN trays, solid quality, 90° opening
patentada, para bandejas GN, apertura 90°
brevetée, pour plateaux GN, ouverture 90°

| | cm | ↑ cm | GN |
|-------|-------------|------|-----|
| 11075 | 53,0 x 32,5 | 19 | 1/1 |



GN Rolltophaube

GN rolltop cover
GN campana rolltop
GN cloche rolltop



patentiert, passend für GN-Behälter, -Tablets, etc., leichtgängig auf- und zuklappbar 90°
patented, suitable for GN trays, solid quality, 90° opening
patentada, para bandejas GN, apertura 90°
brevetée, pour plateaux GN, ouverture 90°

| | cm | ↑ cm | GN | |
|-------|-------------|------|-----|--|
| 11008 | 53,0 x 32,5 | 19 | 1/1 | vergoldeter Griff / gold plated handle pomo dorado / bouton doré |
| 11010 | 53,0 x 32,5 | 19 | 1/1 | verchromter Griff / chrome plated handle pomo cromado / bouton chromé |
| 12008 | 32,5 x 26,5 | 15 | 1/2 | vergoldeter Griff / gold plated handle pomo dorado / bouton doré |
| 12010 | 32,5 x 26,5 | 15 | 1/2 | verchromter Griff / chrome plated handle pomo cromado / bouton chromé |



GN 1/1 Rolltophaube „SUNDAY“

GN 1/1 rolltop cover
GN 1/1 campana rolltop
GN 1/1 cloche rolltop



Griff ABS verchromt, leichtgängig auf- und zuklappbar
handle chrome plated, easy to open and close
asa material ABS cromado, fácil de abrir y cerrar
poignée matériel ABS chrome, ouverture et fermeture faciles

| | cm | ↑ cm | GN |
|-------|-------------|------|-----|
| 11016 | 53,0 x 32,5 | 19 | 1/1 |



GN 1/1 Rolltophaube

GN 1/1 rolltop cover
GN 1/1 campana abatible
GN 1/1 cloche basculante



verchromter Zinkdruckguss-Griff / chrome plated metal handle / mango cromado de fundición a presión de zinc / poignée en zinc moulé sous pression chromé

| | cm | ↑ cm | GN |
|-------|-------------|------|-----|
| 11018 | 53,0 x 32,5 | 19 | 1/1 |



Rolltophaube „FOCUS“

rolltop cover
campana abatible
cloche basculante



verchromter Griff / chrome plated handle / pomo cromado / bouton chromé

| | cm | ↑ cm |
|-------|-----------|------|
| 09013 | 44 x 33,5 | 17 |

ROLLTOP COVERS



Rolltophaube

rolltop cover
campana abatible
cloche basculante

glasklarer Kunststoff, leichtgängig auf- und zuklappen 90°

solid quality, to be opened 90°

plástico transparente, apertura 90°

plastique transparent résistant, ouverture 90°



| | Ø cm | ↑ cm | |
|-------|------|------|---|
| 18388 | 38 | 20 | mit verchromtem Kugelgriff / with chrome plated handle con pomo cromado / avec bouton chromé |
| 18387 | 38 | 20 | mit vergoldetem Kugelgriff / gold plated handle pomo dorado / bouton doré |
| 09023 | 38 | 20 | mit verchromtem Zylindergriff / chrome plated handle pomo cromado / bouton chromé |
| 18380 | 50 | 26 | mit verchromtem Zylindergriff / chrome plated handle pomo cromado / bouton chromé |



Frischhaltehaube

cover
campana
cloche

schwere, glasklare Qualität

stable, crystal clear quality

calidad estable y transparencia cristalina

qualité stable et clarté cristalline



| | Ø cm | ↑ cm | fits to |
|-------|------|------|--|
| 06519 | 21 | 17 | 84941, 84942 |
| 06520 | 30 | 22 | 85034, 84177, 83891, 83890, 83884, 998, 975, 469, 468, 463, 462, 46 |
| 06521 | 36 | 27 | 84945, 84946 |



stapelbar
stackable

Präsentationsmöglichkeiten
presentation examples

SUPER DOME



Frischhaltehaube „SUPER DOME“

cover
campana
cloche

schwere, glasklare Qualität
stable, crystal clear quality
muy resistente y transparencia cristalina
haute résistance et transparence



| | Ø cm | ↑ cm |
|-------|------|------|
| 06525 | 30 | 40 |

passende Servier- Tortenplatten / suitable cake stands / porta pasteles compatibles /
présentoirs à gâteaux compatibles

| | Ø cm | ↑ cm | fits to | Farbe / Colour |
|-------|------|------|---------|----------------|
| 00468 | 31,0 | 3,5 | 06525 | |
| 33294 | 33,0 | 8,0 | 06525 | |
| 33295 | 33,0 | 16,0 | 06525 | |



Servierbeispiel
presentation example

Präsentationsmöglichkeiten
presentation examples

PLATE COVERS



Tellerabdeckhaube

plate cover
cubierta para plato
couvertcle pour assiette



passend für unterschiedliche Tellergrößen

suitable for different plate sizes
aptas para diferentes tamaños de platos
aptes pour différentes tailles d'assiettes

| | Ø cm | ↑ cm | passend für Tellergrößen / suitable for plate sizes |
|-------|------|------|--|
| 11051 | 22,0 | 7,0 | Ø 21,5 cm |
| 11052 | 24,0 | 7,5 | Ø 22,5 - 23,0 cm |
| 11053 | 28,0 | 6,5 | Ø 26,0 - 26,5 cm |
| 11054 | 28,5 | 6,5 | Ø 27,0 - 27,5 cm |



Servierbeispiele
presentation example



passende Hauben
suitable covers 11051, 11052



Frischhaltehaube

cover
campana
cloche bombée



glasklar, Griff verchromt, schwere, stabile Ausführung

transparent, chrome knob, heavy stable quality

transparente, asa cromada, alta estabilidad

transparente, anse chromée, très stable

| | Ø cm | ↑ cm | fits to |
|-------|------|------|---------------------|
| 15350 | 16,5 | 10 | 15130 |
| 15351 | 20,5 | 10 | 15131, 15141, 15271 |





06512

Frischhaltehaubecover
campana
cloche**glasklar, schwere stabile Ausführung, stapelbar**clear, heavy stable quality, stackable
transparente, alta estabilidad, apilable
transparente, très stable, empilable

| | Ø cm | ↑ cm | |
|-------|------|------|--|
| 06512 | 30 | 11,5 | mit verchromtem Griff / with chrom plated handle con botón cromado / avec bouton chromé |
| 06517 | 30 | 11,5 | mit verchromtem Griff / with chrom plated handle con botón cromado / avec bouton chromé |



06515

Frischhaltehaubecover
campana
cloche**glasklar, schwere stabile Ausführung, stapelbar**clear, heavy stable quality, stackable
transparente, alta estabilidad, apilable
transparente, très stable, empilable

| | Ø cm | ↑ cm | |
|-------|------|------|--|
| 06510 | 30 | 11,5 | |
| 06515 | 33 | 12,5 | |

**stapelbar**
stackable

06501

Frischhaltehaubecover
campana
cloche

| | Ø cm | ↑ cm | |
|-------|------|------|--|
| 06501 | 30 | 11 | |
| 06504 | 30 | 9,5 | |
| 06506 | 30 | 7 | |

**Frischhaltehauben, 2er Set**covers, 2 pcs. set
campanas, set de 2
cloches, pack de 2

| | Ø cm | ↑ cm | |
|-------|------|------|--|
| 40752 | 30 | 11 | |

COVERS



Frischhaltehaube

cover
campana
cloche



| | Ø cm | ↑ cm | fits to |
|-------|------|------|---------|
| 11055 | 23 | 12 | 00827 |



Set 00827

glasklar, schwere stabile Ausführung
clear, heavy stable quality



Frischhaltehaube

cover
campana
cloche



| | cm | ↑ cm | fits to |
|-------|---------|------|---------|
| 11056 | 25 x 12 | 10 | 00828 |



Set 00828

glasklar, schwere stabile Ausführung
clear, heavy stable quality



Frischhaltehaube

cover
campana
cloche



| | cm | ↑ cm |
|-------|-------------|------|
| 06401 | 29,5 x 13,5 | 10 |
| 06701 | 21,6 x 16,2 | 7 |



18621

Lieferung ohne Tablett | delivery without tray

18121

Frischhaltehaube

cover
campana
cloche



| | cm | ↑ cm |
|-------|-------------|------|
| 18621 | Ø 18 | 8,5 |
| 18121 | 35,5 x 27,8 | 7,5 |

FRIDA



... zu jeder Schale der
PASSENDE
DECKEL



84962 Ø 9 cm



84963 Ø 13 cm



84964 Ø 16 cm

Deckel „FRIDA“

cover
tapa
couvercle



| | Ø cm | ↑ cm | fits to | € |
|-------|------|------|--------------|---|
| 84962 | 9 | 2,5 | 84930, 84931 | |
| 84963 | 13 | 2,5 | 84605, 84606 | |
| 84964 | 16 | 2,5 | 84607, 84608 | |



84931



84607



84608

84962
84931
84962
8493084963
84606

stapelbar / stackable



84965 13 x 13 cm



84966 17 x 17 cm



84967 18 x 16,5 cm



84968 18 x 11 cm

Deckel „FRIDA“

cover
tapa
couvercle



| | cm | ↑ cm | fits to | € |
|-------|-----------|------|--------------|---|
| 84965 | 13 x 13,0 | 2,5 | 84937, 84936 | |
| 84966 | 17 x 17,0 | 2,5 | 84558, 84559 | |
| 84967 | 18 x 16,5 | 2,5 | 84584, 84583 | |
| 84968 | 18 x 11,0 | 2,5 | 84556, 84555 | |



84937



84559



84558

84968
84556
84968
8455584967
84584

stapelbar / stackable



Deckel „FLOAT“ mit Löffelaussparung
 cover, with notched for spoons
 tapa, con espacio para la cuchara
 couvercle, avec encoche pour la louche



| | cm | ↑ cm | fits to | |
|-------|---------|------|-----------------------------------|-------|
| 83920 | Ø 20,5 | 1,3 | 00794, 83908, 83909, 85250, 85252 | rund |
| 83921 | 19 x 19 | 1,3 | 83916, 83917 | eckig |
| 83922 | 25 x 25 | 1,3 | 83918, 83919 | eckig |



Deckel „PURE“ mit Löffelaussparung
 cover with notched for spoons
 tapa con espacio para la cuchara
 couvercle avec encoche pour la louche



| | cm | ↑ cm | fits to |
|-------|---------|------|---|
| 83600 | 19 x 19 | 1,5 | 79004, 79005, 83409, 83468, 84244, 85260, 85266 |
| 83601 | 25 x 25 | 1,5 | 83469, 83408, 84245, 84561, 84562, 85261, 85267 |



Deckel „PURE“, 5er Set
 cover, 5 pcs.
 tapa, set de 5
 couvercle, set de 5



Hygienischer Schutz für Ihre Speisen
 • dichtschießend
 • schwappsicherer Transport
 protection for your food
 • tightly closing
 • slosh-proof transport

protección de alimentos
 • con cierre hermético
 • transporte sin salpicaduras
 protection des aliments
 • fermeture hermétique
 • transport sans éclaboussures

| | Ø cm | ↑ cm | fits to | pcs. |
|-------|-------------|------|--|------|
| 83603 | 13,0 x 13,0 | 0,5 | 83410, 83467 | 5 |
| 83604 | 19,5 x 19,5 | 0,5 | 79004, 79005, 83409, 83468, 84244, 84830, 85261, 85267 | 5 |



Deckel „CASUAL“, 5er Set
 cover, 5 pcs. set
 tapa, set de 5
 couvercle, set de 5



Hygienischer Schutz für Ihre Speisen
 • dichtschießend
 • schwappsicherer Transport
 protection for your food
 • tightly closing
 • slosh-proof transport

protección de alimentos
 • con cierre hermético
 • transporte sin salpicaduras
 protection des aliments
 • fermeture hermétique
 • transport sans éclaboussures

| | Ø cm | ↑ cm | fits to | pcs. |
|-------|------|------|---|------|
| 83605 | 8,0 | 0,5 | 11866, 15400, 15416, 15461, 15462, 15467, 40655, 40656, 83881 | 5 |
| 83606 | 14,5 | 0,5 | 11865, 83700, 83701, 85104, 85105, 85107 | 5 |
| 83607 | 20,5 | 0,5 | 15404, 15420, 83704, 83705 | 5 |

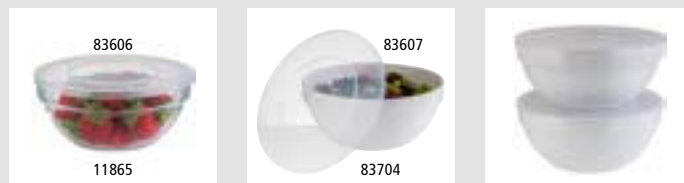

stapelbar
 stackable



10890

Frischhaltedeckel

airtight cover
tapa hermética
couvercle hermétique



mit Silikondichtung, für luftdichtes Verschließen, Lebensmittel bleiben lange frisch

with silicone sealing ring, bowls closed airtight, to keep food fresh for a long time
junta de silicona para cerrar herméticamente y mantener los alimentos frescos más tiempo
joint de silicone pour fermeture hermétique et meilleure conservation des aliments

| | Ø cm | fits to |
|-------|------|-----------------------------------|
| 10890 | 14 | 11865, 83700, 83701 |
| 10887 | 23 | 11846, 11848, 11875, 83702, 83703 |



zwei Öffnungspositionen des Deckels
two opening positions of the lid



11868

11878

Schutzdeckel mit Löffelaussparung

cover
tapa
couvercle



glasklar, klappbar, mit 10 Beschriftungsschildern

transparent, with 10 cards for inscription
plástico transparente, con 10 etiquetas para inscripción
plastique transparent, avec 10 étiquettes pour inscription

| | Ø cm | |
|-------|------|---|
| 11868 | 14,5 | mit verchromtem Griff / chrome plated handle botón cromado / bouton chromé |
| 11878 | 23,5 | mit verchromtem Griff / chrome plated handle botón cromado / bouton chromé |

Schilder, 10er Set / signs, 10 pcs. set / set de 10 cartelitos / set de 10 étiquettes

| | fits to |
|-------|---------|
| 12879 | 11868 |
| 11879 | 11878 |



Deckel klappbar mit Löffelaussparung

cover hinged
tapa con bisagra
couvercle avec charnière



glasklar, mit Designer-Griff, verchromt, ohne Beschriftungsschild

clear, with designer handle, chrome plated, without card for inscription
transparente, con pomo de diseño cromado, sin tarjetas para inscripción
transparent, avec bouton chromé de design, sans étiquette pour inscription

| | Ø cm | fits to |
|-------|------|-----------------------------------|
| 10889 | 23,5 | 11817, 11818, 11845, 11847, 11849 |



11875

Schale

bowl
cuenco
bol



| | Ø cm | ↑ cm | ltr. | VE / unit |
|-------|------|------|------|-----------|
| 11859 | 6,0 | 2,5 | 0,05 | 36 |
| 11866 | 7,5 | 3,5 | 0,09 | 36 |
| 11865 | 14,0 | 6,5 | 0,50 | 6 |
| 11875 | 23,0 | 10,5 | 2,50 | 6 |

COOLERS



Kühlakku

cooler
acumulador de frío
accumulateur de froid



gefüllt mit Kühlflüssigkeit, nicht giftig, einfach im Gefrierfach einfrieren, unbegrenzt wiederverwendbar

freeze it in freezer, non toxic, filled with freezer-liquid, boundless reusable
se enfría en el congelador, no tóxico, se puede reutilizar sin límite
liquide eutectique qui accumule froid une fois dans le congélateur, non toxique, réutilisable sans limites

| | Ø cm | ↑ cm | Farbe / Colour |
|-------|------|------|----------------|
| 10777 | 15 | 2,5 | White |
| 10781 | 10,5 | 2,5 | White |
| 10661 | 10,5 | 2,0 | White |



Kühlakku

cooler
acumulador de frío
accumulateur de froid



| | Ø cm | → cm | Farbe / Colour |
|-------|------|------|----------------|
| 00615 | 7,5 | 11,5 | Black |



Kühlakku

cooler
acumulador de frío
accumulateur de froid



gefüllt mit Kühlflüssigkeit, nicht giftig, einfach im Gefrierfach einfrieren, unbegrenzt wiederverwendbar

freeze it in freezer, non toxic, filled with freezer-liquid, boundless reusable
se enfría en el congelador, no tóxico, se puede reutilizar sin límite
liquide eutectique qui accumule froid une fois dans le congélateur, non toxique, réutilisable sans limites

| | cm | ↑ cm | Farbe / Colour | |
|-------|----------|------|----------------|--|
| 10782 | 41 x 21 | 2,5 | White | |
| 10791 | 25 x 19 | 2,5 | White | |
| 11101 | 16 x 7,5 | 2,0 | Blue | 4er Set / 4 pieces set / set de 4 / set de 4 |



Aufsteller „ACHTUNG RUTSCHGEFAHR“

stand
letrero
panneau



| | cm | ↑ cm | Farbe / Colour |
|-------|---------|------|----------------|
| 71421 | 30 x 63 | 63 | Yellow |

NEW

Der nachhaltige Mehrwegbecher – made in Germany



eco-friendly

400 ml



Das Rippendesign isoliert die Hitze – kein „Verbrennen“ der Finger möglich

The rib design insulates the heat - no „burning“ of the fingers possible

Mehrwegbecher individuell mit Ihrem Logo/Namen herstellbar ab 500 Stck. – sprechen Sie uns an!

Reusable cups can be individually produced with your logo/name. From 500 pieces - please contact us!

- ✓ aufsteckbarer Deckel mit Trinköffnung
- ✓ 100% recyclebar
- ✓ spülmaschinengeeignet
- ✓ stapelbar mit und ohne Deckel
- ✓ schwappsicher

- clip-on lid with drinking opening
- 100% recyclable
- dishwasher safe
- stackable with and without lid
- slosh-/leak-proof

NEW



To Go Mehrwegbecher

To Go reusable cup
vaso reutilizable To Go
tasse réutilisable To Go

Becher (ohne Deckel)

cup (without cover)

vaso (sin tapa)

tasse (sans couvercle)



| | Ø cm | ↑ cm | ltr. | Farbe / Colour | VE / unit |
|-------|------|------|------|----------------|-----------|
| 66910 | 8,5 | 13,5 | 0,4 | | 48 |
| 66911 | 8,5 | 13,5 | 0,4 | | 48 |
| 66912 | 8,5 | 13,5 | 0,4 | | 48 |
| 66913 | 8,5 | 13,5 | 0,4 | | 48 |

Deckel / cover / tapa / couvercle

| | Ø cm | ↑ cm | Farbe / Colour | VE / unit |
|-------|------|------|----------------|-----------|
| 66914 | 8,5 | 2,5 | | 48 |
| 66915 | 8,5 | 2,5 | | 48 |
| 66916 | 8,5 | 2,5 | | 48 |
| 66917 | 8,5 | 2,5 | | 48 |

*Laser-Logo
Individual*

Laserlogo Individual

- perfekte Lasergravuren
- perfectly Laser engravings
- grabado perfecto por láser
- marcage laser parfait



DE

- unverwechselbar
- einzigartig
- imagefördernd

Ihre individuelle Lasergravur von APS

Wir bieten Ihnen die Möglichkeit, unsere Produkte mit Ihrem individuellen Logo per Laser zu gravieren - einzigartig, unverwechselbar und bereits ab 10 Stück je Artikel. Die perfekte Beschriftung durch modernste Lasertechnologie ist spülmaschinenfest und somit dauerhaft auf allen Edelstahl- und Naturschieferprodukten, sowie auf versilberten und verchromten Metall-Artikeln umsetzbar. Machen Sie aus Ihren Gastronorm-Behältern Ihre ganz persönlichen Unikate und werten Sie Ihre Servierartikel mit Ihrem eigenen Logo auf.

- geringe Mindestbestellmenge von nur 10 Stück
- kurze Lieferzeiten
- Logos bis zu einer Fläche von max. 10 x 10 cm realisierbar

ES

- único
- personalizado
- promotor de imagen

Grabado laser por APS

Podemos grabar su logo y así personalizar los productos APS a partir de mínimo 10 unidades por referencia. Gracias a la novedosa tecnología de grabado por láser, la inscripción es perfecta y resistente al lavavajillas. Se puede aplicar a los artículos en acero inoxidable, pizarra natural, metal cromado y plateado.

- cantidad mínima de solamente 10 unidades
- realización rápida
- tamaño de logos hasta máximo 10 x 10 cm

EN

- distinct
- unique
- image enhancing

Your individualised laser engraving by APS

We offer you the option of having your personalised logo engraved on our products - inimitable, unique, and available for delivery from only 10 pieces per product. The perfect inscription by use of the newest technology is dishwasher-safe and thus can be permanently applied to products made of stainless steel and natural slate, as well as silver-coated and chromed metal articles. Turn your gastronorm container into your individual, one of a kind article and enhance your serving items with your own logo.

- minimum order quantity of only 10 pieces
- swift delivery
- feasible logos are those with a maximum size of 10 x 10 cm

FR

- unique
- original
- porteur d'image

Marcage laser par APS

Nous pouvons graver votre logo et ainsi personnaliser les produits APS à partir de 10 pièces par référence. Grâce à une technologie d'avant-garde de marquage par laser, l'inscription est parfaitement reproduite et résistante au lave-vaisselle. Ce type de marquage peut s'appliquer sur l'acier inoxydable, sur l'ardoise naturelle, sur le métal chromé ou argenté.

- quantité minimum de seulement 10 unités
- fabrication rapide
- taille du logo jusque 10 x 10 cm



APS - BSCI-Mitglied

APS engagiert sich für die Verbesserung von Arbeitsbedingungen.

Wir sind Partner der europäischen Organisation BSCI. Die "Business Social Compliance Initiative" (BSCI) ist eine Initiative von Unternehmen zur Verbesserung der Arbeitsbedingungen in der globalen Versorgungskette.



APS is a member of BSCI

APS is committed to the improvement of working conditions.

We are a partner of the European organization BSCI. The "Business Social Compliance Initiative" is an initiative of enterprises to improve working conditions in the global supply chain.

APS Melamin - Garantierte Qualität

APS-Melaminprodukte entsprechen den Richtlinien (EG) 1935/2004 und (EU) 10/2011 der Europäischen Kommission. Diese enthalten Bestimmungen für Materialien aus Kunststoffen, welche mit Lebensmitteln in Berührung kommen. Wir arbeiten sehr eng mit Zertifizierungsinstitutionen und Prüflaboren zusammen und können somit die Lebensmittelsicherheit (LFGB Regulation) der APS-Melaminartikel garantieren.

APS Melamine - Guaranteed quality

APS melamine products comply with directives (EG) 1935/2004 and (EU) 10/2011 of the European Commission. This contain provisions for plastic materials which come into contact with foodstuffs. We work very closely together with certification institutions and testing laboratories and are therefore able to guarantee the compatibility with foodstuffs (German LFGB regulation) of APS melamine.

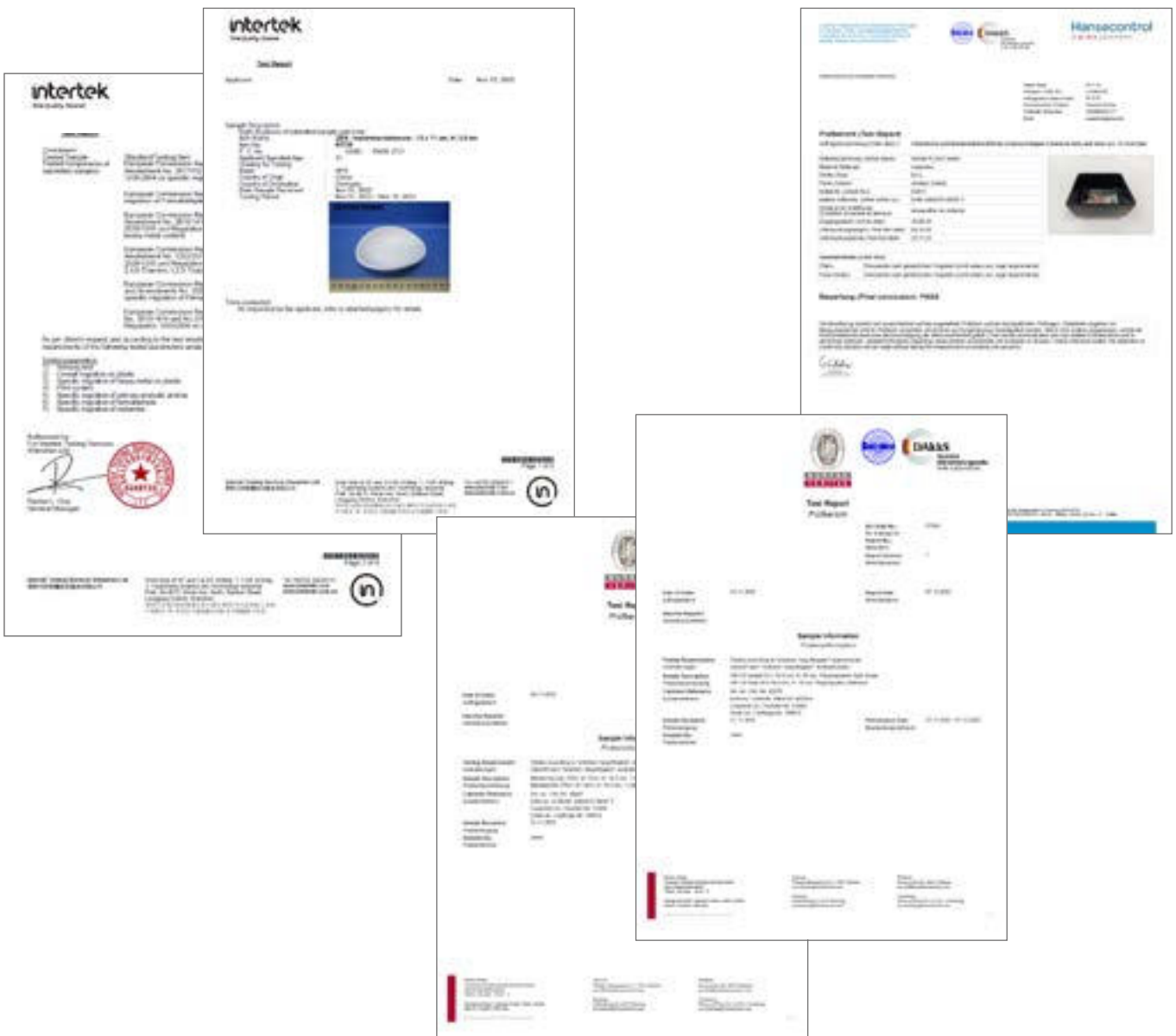



Icon-Index

| | | | |
|---|---|---|---|
|  neuer Artikel new item |  spülmaschinengeeignet dishwasher-proof |  für Induktionsplatten for induction use |  max. 70°C |
|  GN-Größen GN norm |  nicht spülmaschinen-geeignet not dishwasher-proof |  feucht abwaschbar wet washable |  kühlbar for cooling |
|  Made in Germany |  Made in the EU |  bruchsicher shatter-proof |  nicht für Lebensmittelkontakt not food safe |
|  mikrowellengeeignet microwave-proof |  Antirutsch-Füßchen non-slip feet |  stapelbar stackable |  Eigenmontage self assembly |
|  nicht mikrowellen-geeignet not microwave-proof |  nicht für Backofen not for baking oven |  keine direkte Hitze not direct heat | |

Material-Index

 **Edelstahl 18/10**
Werkstoff 1.4301; rostfrei; langlebig; gute isolierende Eigenschaften; absolut hygienisch und nicht toxisch; recyclebar; nicht resistent gegen dauerhaften Kontakt mit Chloriden und Säuren (z. B. Kochsalz und Fruchtsäuren); sterilisierbar; Oberfläche lässt sich vielfältig polieren; nicht magnetisch; Gebrauchstemperatur bis ca. 400 °C
Pflege
pflegeleicht; maschinell oder per Hand mit milden Spülmitteln; möglichst keine Stahlwolle u. ä. verwenden; nach Erhitzung Schockabkühlung vermeiden

 **Edelstahl (unspezifisch)**
niedrig nickelhaltige Edelstähle wie 14/4; nicht magnetisch; geringere allgemeine Resistenz als Edelstahl 18/10;
Pflege:
pflegeleicht; maschinell oder per Hand mit milden Spülmitteln; möglichst keine Stahlwolle u. ä. verwenden; nach Erhitzung Schockabkühlung vermeiden

 **Edelstahl 18/0**
Werkstoff 1.4016; rostfrei; langlebig bei entsprechender Pflege; absolut hygienisch und nicht toxisch; gut härtbar, daher idealer Stahl für Tafelmesser, Tablett, Schneidwerkzeuge u. ä.; lässt sich hochglanzpolieren; für Nickelallergiker geeignet; magnetisch; nicht so chemikalienresistent wie Edelstahl 18/10; Gebrauchstemperatur bis ca. 400 °C
Pflege:
maschinell oder per Hand mit milden Spülmitteln; Ablagerungen von Kalk und Reinigerresten nach dem Spülen unbedingt entfernen; niemals mit Stahlwolle reinigen

 **Eisen**
nicht rostfrei; charakteristische, strukturierte Oberfläche mit unterschiedlichen Schattierungen; durch wiederholten Schmiedevorgang ist das Material stark verdichtet und sehr hart; langlebig bei entsprechender Pflege
Pflege:
vor erstem Einsatz mit Öl und Kartoffelschalen „einbraten“; später nach jeder Reinigung einfetten; stets trocken lagern

Stainless steel 18/10
Material 1.4301; stainless; durable; good insulating properties; absolutely hygienic and non-toxic; recyclable; not resistant to permanent contact with chlorides and acids (e.g. table salt and fruit acids); sterilisable; surface can be polished in many ways; non-magnetic; service temperature up to approx. 400 °C
Care
easy to clean; machine or hand wash with mild detergents; if possible, do not use steel wool or similar; Avoid shock cooling after heating.

Stainless steel (unspecific)
Stainless steel with low nickel content such as 14/4; non-magnetic; lower general resistance than 18/10 stainless steel
Care:
easy to clean; machine or hand wash with mild detergents; if possible, do not use steel wool or similar; Avoid shock cooling after heating.

Stainless steel 18/0
Material 1.4016; stainless; long-lasting with appropriate care; absolutely hygienic and non-toxic; good hardening properties, therefore ideal steel for table knives, trays, cutting tools, etc.; can be polished to a high gloss; suitable for people allergic to nickel; magnetic; not as resistant to chemicals as stainless steel 18/10; service temperature up to approx. 400 °C
Care:
by machine or by hand with mild detergents; Remove limescale and detergent residues after cleaning; never clean with steel wool

Iron
not rustproof; characteristic, structured surface with different shades; due to repeated forging process, the material is strongly compressed and very hard; long-lasting with appropriate care,
Care:
before first use, fry with oil and potato peelings; later grease after each cleaning; always store in a dry place.



Gusseisen

langlebig bei entsprechender Pflege; geeignet für alle Herdarten (inkl. Induktion); speichert lange Wärme und gibt sie gleichmäßig ab; absolut hygienisch bei unbeschädigter Oberfläche; relativ schweres Material; Überhitzung fast nicht möglich; nicht schlagfest; magnetisch



Pflege:

nach Gebrauch sofort mit heißem Wasser reinigen; bei Fleckenbildung mit Essig nachreinigen; niemals mit Stahlwolle reinigen; milde Spülmittel verwenden; stets trocken lagern



Versilberter Stahl

Edelmetallüberzug; nicht völlig säurefest; nicht über längere Zeit Sonnenlicht aussetzen

Pflege:

niemals scheuernde Hilfsmittel verwenden; nur mit weichem Lappen und Spezialmitteln reinigen; keine Spülmaschinenreinigung!



Verchromter Stahl

nichtedles Metall mit hartem Chromüberzug; nicht säurefest; nach Beschädigung der Chromschicht kein Schutz gegen Umwelteinflüsse

Pflege:

niemals scheuernde Hilfsmittel verwenden; nur mit weichem Lappen



Aluminium

sehr leichtes Material; sehr gute elektrische und thermische Leitfähigkeit; korrosionsbeständig; Gebrauchstemperatur bis ca. +500 °C

Pflege:

niemals scheuernde Hilfsmittel verwenden; nur mit weichem Lappen und Spezialmitteln reinigen; keine Spülmaschinenreinigung!

Cast Iron

Long-lasting with appropriate care; suitable for all types of cookers (incl. induction); stores heat for a long time and releases it evenly; absolutely hygienic with undamaged surface; relatively heavy material; overheating is almost impossible; not impact-resistant; magnetic

Care:

clean immediately with hot water after use; clean with vinegar if stains form; never clean with steel wool; use mild detergents; always store in a dry place

Silver plated steel

Metal coating; not completely acid-resistant; do not expose to sunlight for long periods of time

Care:

never use abrasive cleaners; clean only with a soft cloth and special cleaning agents; not suitable for dishwashers

Chrome plated steel

Metal with hard chrome coating; not acid-resistant; after damage to the chrome layer no protection against environmental influences

Care:

never use abrasive cleaners; only with a soft cloth

Aluminium

Very light material; very good electrical and thermal conductivity; corrosion-resistant; service temperature up to approx. +500 °C

Care:

never use abrasive cleaners; clean only with a soft cloth and special cleaning agents; not suitable for dishwashers



ABS – Acrylnitril-Butadien-Styrol

sehr gute Oberflächenhärte; temperaturwechselfest; Gebrauchstemperatur bis ca. +100 °C

Pflege:

spülmaschinengeeignet

ABS - acrylonitrile butadiene styrene

very good surface hardness; resistant to temperature changes; service temperature up to approx. +100 °C

care:

dishwasher safe



ACRYL – künstliches Harz

farblos; glasartig; durchsichtig; nicht splitternd; chemisch modifiziert als Plexiglas®; Gebrauchstemperatur ca. -40 °C bis ca. +50 °C

wichtiger Pflegehinweis:

nur handelsübliche Acrylspezialreiniger oder milde alkohol- und ammoniakfreie Reinigungsmittel verwenden; nicht spülmaschinengeeignet;

ACRYL - artificial resin

colourless; glass-like; transparent; not splintering; chemically modified as Plexiglas®; service temperature approx. -40 °C to approx. +50 °C

important care advice:

use only commercially available acrylic special cleaners or mild and ammonia-free cleaning agents; not suitable for dishwashers



EVA - Ethylenvinylacetat

weich elastisch; glänzend; Gebrauchstemperatur bis ca. +60 °C

Pflege:

abwaschbar / wasserfest

EVA - ethylene vinyl acetate

soft elastic; glossy; service temperature up to approx. +60 °C

care:

washable / waterproof



GFK – Glasfaserverstärkter Kunststoff

starr; nahezu unzerbrechlich; Gebrauchstemperatur bis ca. +100 °C

Pflege:

spülmaschinengeeignet

GFK - glass-fibre reinforced plastic

rigid; almost unbreakable; service temperature up to approx. +100 °C

care:

dishwasher-safe



MF - Melamin

sehr hart; stoß- und kratzfest; hygienisch; Gebrauchstemp. ca. -30 °C bis +70 °C

Pflege:

säurebeständig; spülmaschinengeeignet

MF - melamine

very hard; impact- and scratch-resistant; hygienic; service temp. approx. -30 °C to +70 °C

care:

acid-resistant; dishwasher safe



MS - Kunststoff

farblos; glasartig; durchsichtig; Gebrauchstemperatur ca. 0 °C bis ca. +70 °C

Pflege:

nicht spülmaschinengeeignet

MS - plastic

colourless; glass-like; transparent; service temperature approx. 0 °C to +70 °C

care:

not dishwasher-safe



PA - Polyamid

starr; bruch- und schlagfest; mattglänzend; Gebrauchstemperatur bis ca. +220 °C

Pflege:

spülmaschinengeeignet

PA - polyamide

rigid; break- and impact-resistant; matt glossy; service temperature up to approx. +220 °C

care:

dishwasher-safe

**PC - Polycarbonat**

starr; nahezu unzerbrechlich; sehr stabil; formbeständig in kochendem Wasser; mikrowelleneeignet; Gebrauchstemperatur ca. -30 °C bis ca. +100 °C
 Pflege:
 spülmaschineneeignet

PC - polycarbonate

rigid; almost unbreakable; very stable; keeps its shape in boiling water; microwave safe; service temperature approx. -30 °C to approx. +100 °C
 care:
 dishwasher-safe

**PE - Polyethylen / HDPE – hochdichtes Polyethylen**

hart elastisch; unzerbrechlich; ausreichend formbeständig in heißem Wasser; glänzend; Gebrauchstemperatur ca. -30 °C bis ca. +120 °C
 Pflege:
 spülmaschineneeignet

PE - polyethylene / HDPE - high-density polyethylene

hard elastic; unbreakable; sufficiently dimensionally stable in hot water; shiny; service temperature approx. -30 °C to approx. +120 °C
 care:
 dishwasher safe

NDPE – niederdichtes Polyethylen

weich elastisch; unzerbrechlich; kurzzeitig formbeständig in heißem Wasser; nicht glänzend; Gebrauchstemperatur ca. -30 °C bis ca. +95 °C
 Pflege:
 spülmaschineneeignet

NDPE - low density polyethylene

soft elastic; unbreakable; briefly keeps its shape in hot water; not shiny; service temperature approx. -30 °C to approx. +95 °C
 care:
 dishwasher safe

**PET - Polyethylenterephthalat**

hart elastisch; ausreichend formbeständig in heißem Wasser; glänzend; Gebrauchstemperatur ca. -30 °C bis ca. +55 °C
 Pflege:
 spülmaschineneeignet bis 55°C

PET - Polyethylene terephthalate

hard elastic; sufficiently dimensionally stable in hot water; shiny; service temperature approx. -30 °C to approx. +55 °C
 care:
 dishwasher safe up to 55°C

**PP - Polypropylen**

hart elastisch; unzerbrechlich; umweltschonend recycelbar; mikrowelleneeignet; Gebrauchstemperatur ca. -30 °C bis ca. +75 °C
 Pflege:
 spülmaschineneeignet

PP - polypropylene

hard elastic; unbreakable; environmentally friendly recyclable; microwave safe; service temperature approx. -30 °C to approx. +75 °C
 care:
 dishwasher safe

**PS - Polystyrol**

starr; kratzfest; formbeständig in kochendem Wasser; Gebrauchstemperatur bis ca. +70 °C
 Pflege:
 spülmaschineneeignet

PS - polystyrene

rigid; scratch-resistant; keeps its shape in boiling water; service temperature up to approx. +70 °C
 care:
 dishwasher safe

**PVC - Polyvinylchlorid**

säurebeständig; schwer entflammbar; Gebrauchstemperatur ca. -50 °C bis +60 °C
 Pflege:
 nicht spülmaschineneeignet

PVC - polyvinyl chloride

acid-resistant; flame-retardant; service temperature approx. -50 °C to +60 °C
 care:
 not dishwasher safe

**SAN - Styrol-Acrylnitril**

gute Oberflächenhärte; temperaturwechselfest; Gebrauchstemperatur bis ca. +100 °C
 Pflege:
 spülmaschineneeignet

SAN - styrene acrylonitrile

good surface hardness; resistant to temperature changes; service temperature up to approx. +100 °C
 care:
 dishwasher safe

**Silikon**

hohe thermische Beständigkeit; gute Kälteflexibilität; Gebrauchstemp. ca. -70 °C bis ca. +180 °C
 Pflege:
 spülmaschineneeignet

Silicone

high thermal resistance; good low-temperature flexibility; service temperature approx. -70 °C to approx. +180 °C
 care:
 dishwasher safe

**Tritan®**

starr; unzerbrechlich; absolut formbeständig; sehr hohe Chemikalienbeständigkeit; Gebrauchstemperatur ca. -30 °C bis ca. +95 °C; nicht mikrowelleneeignet
 Pflege:
 spülmaschineneeignet

Tritan®

rigid; unbreakable; keeps its shape in boiling water; very high chemical resistance; service temperature approx. -30 °C to approx. +95 °C; not microwaveable
 care:
 dishwasher safe

BETON
CONCRETE

Beton

Werkstoff Beton, coole optik; handgefertigt

Pflege:

nicht spülmaschinengeeignet

PORZELAN
PORCELAIN

Porzellan

hitzebeständig bis ca. +220 °C

Pflege:

spülmaschinengeeignet

SCHIEFER
SLATE

Schiefer

Naturschiefer versiegelt; lebensmittelecht;

Pflege:

nicht spülmaschinengeeignet

KUNST
FASER
TETRON

Tetron

Kunstfaser: 65% Polyester, 35% Viskose

Pflege:

Maschinenwaschbar bis 30 grad

Concrete

Concrete material, cool look; handmade

care:

not dishwasher safe

Porcelain

heat-resistant up to approx. +220 °C

care:

dishwasher safe

Slate

Natural slate sealed; food-safe

care:

not dishwasher safe

Tetron

Artificial fibre: 65% polyester, 35% viscose

care:

Machine washable up to 30 degrees

HOLZ
WOOD

Holz

lebensmittelecht; nicht spülmaschinengeeignet; naturbedingte Abweichung in Form, Farbe, Maserung und Größe; Abweichungen stellen keinen Mangel dar

Pflege:

Direkt nach dem Gebrauch sollten Holzprodukte abgespült und mithilfe einer Spülbürste gereinigt werden. Auch Spülmittel dürfen zur Reinigung verwendet werden. Wir empfehlen auf beiden Seiten zu spülen, damit im Holz keine Spannungen durch einseitige Befeuchtung entstehen. Danach gut abtrocknen und die restliche Feuchtigkeit auf einem Tuch abtropfen lassen. So können die Produkte gleichmäßig von beiden Seiten trocknen. Weichen Sie das Holzschneidbrett nicht ein und lassen Sie es auch nicht im Wasser liegen. Auch nicht in Ofennähe trocknen lassen.

Wie kann man Holzprodukte ölen?

Nicht nur die Reinigung spielt für die Produkte eine wichtige Rolle, sondern auch die Aufrechterhaltung seiner Kondition. Mit ein wenig Öl lässt sich beim Holz daher jede Menge erreichen, denn wird die Oberfläche mit Öl eingerieben, kommt es zur Schließung der Poren.

Beim Ölen sollte allerdings darauf geachtet werden, dass es sich um ein geschmacksneutrales oder geruchloses Öl handelt. Empfehlenswert sind hierbei entweder Traubenkernöl oder auch Mandelkernöl. Vorsicht: sollte man unter einer Nussallergie leiden, ist von der Benutzung des Mandelöls abzuraten). Sie können fast jedes Salatöl verwenden. Dabei gilt die Grundregel: je höher raffiniert umso besser, da es dadurch nicht so leicht ranzig wird. Ein weiteres Öl, das verwendet werden kann, ist Weissöl aus der Apotheke. Auf Olivenöl sollte verzichtet werden, denn dann kann das Brett ranzig riechen und verkleben.

So geht's: Tröpfeln Sie etwas Öl auf das Schneidbrett und verreiben Sie es gleichmäßig auf allen Seiten.

Wood

food-safe; not dishwasher-safe; natural deviation in shape, colour, grain and size; deviations do not constitute a defect

Care:

Immediately after use, wooden products should be rinsed and cleaned with a dishwashing brush. Washing-up liquid may also be used for cleaning. We recommend rinsing on both sides so that no tensions arise in the wood due to one-sided moistening. Then dry well and let the remaining moisture drip off on a cloth. This allows the products to dry evenly from both sides. Do not soak the wooden chopping board or leave it in water. Also do not let it dry near the oven.

How to oil wooden products?

Not only cleaning plays an important role for the products, but also maintaining its condition. A little oil can therefore achieve a lot with wood, because if the surface is rubbed with oil, the pores are closed.

When oiling, however, care should be taken that the oil is tasteless or odourless. Grape seed oil or almond seed oil are recommended. Caution: if you suffer from a nut allergy, it is not advisable to use almond oil. You can use almost any salad oil. The basic rule is: the more highly refined the better, as this makes it less likely to go rancid. Another oil that can be used is white oil from the pharmacy. Olive oil should be avoided, because then the board can smell rancid and stick together.

How to do it: Drip some oil onto the chopping board and rub it evenly on all sides.



Index

| Artikel-Nr. | Prüfziffer | Seite | | | | | | |
|-------------|------------|----------|-------|---|-------------------------|-------|---|--------------------|
| 0 | | | | | | | | |
| 00011 | 7 | 300 | 00311 | 8 | 296 | 00568 | 6 | 428 |
| 00012 | 4 | 300 | 00381 | 1 | 101 | 00570 | 9 | 428 |
| 00013 | 1 | 304 | 00382 | 8 | 101 | 00572 | 3 | 304 |
| 00016 | 2 | 295 | 00383 | 5 | 101 | 00574 | 7 | 430 |
| 00017 | 9 | 304 | 00384 | 2 | 101 | 00576 | 1 | 430 |
| 00018 | 6 | 295 | 00385 | 9 | 101 | 00578 | 5 | 429 |
| 00019 | 3 | 295 | 00388 | 0 | 101 | 00580 | 8 | 431 |
| 00020 | 9 | 295 | 00389 | 7 | 108 | 00581 | 5 | 426 |
| 00021 | 6 | 300 | 00391 | 0 | 108 | 00582 | 2 | 427 |
| 00022 | 3 | 298 | 00392 | 7 | 108 | 00583 | 9 | 427 |
| 00023 | 0 | 300 | 00393 | 4 | 108 | 00584 | 6 | 427 |
| 00025 | 4 | 295 | 00394 | 1 | 108 | 00585 | 3 | 427 |
| 00026 | 1 | 295 | 00395 | 8 | 108 | 00586 | 0 | 429 |
| 00027 | 8 | 296 | 00396 | 5 | 108 | 00587 | 7 | 439 |
| 00029 | 2 | 296 | 00397 | 2 | 108 | 00588 | 4 | 438 |
| 00030 | 8 | 301 | 00398 | 9 | 108 | 00589 | 1 | 438 |
| 00031 | 5 | 296 | 00399 | 6 | 108 | 00590 | 7 | 438 |
| 00032 | 2 | 270 | 00401 | 6 | 276 | 00591 | 4 | 438 |
| 00033 | 9 | 267, 417 | 00463 | 4 | 135, 289 | 00592 | 1 | 439 |
| 00036 | 0 | 301 | 00468 | 9 | 136, 216, 288, 290, 489 | 00593 | 8 | 439 |
| 00037 | 7 | 299 | 00469 | 6 | 216, 288 | 00594 | 5 | 439 |
| 00040 | 7 | 469 | 00500 | 6 | 131, 423 | 00595 | 2 | 438 |
| 00042 | 1 | 469 | 00502 | 0 | 132, 424 | 00596 | 9 | 439 |
| 00046 | 9 | 135, 289 | 00506 | 8 | 131, 423 | 00597 | 6 | 439 |
| 00047 | 6 | 135, 289 | 00508 | 2 | 132, 424 | 00598 | 3 | 439 |
| 00048 | 3 | 430 | 00510 | 5 | 131, 423 | 00599 | 0 | 455 |
| 00050 | 6 | 430 | 00511 | 2 | 131, 423 | 00600 | 3 | 444 |
| 00052 | 0 | 428 | 00515 | 0 | 131, 423 | 00601 | 0 | 445 |
| 00054 | 4 | 428 | 00521 | 1 | 132, 424 | 00602 | 7 | 445 |
| 00056 | 8 | 428 | 00522 | 8 | 132, 424 | 00603 | 4 | 444 |
| 00060 | 5 | 302 | 00524 | 2 | 132, 424 | 00604 | 1 | 444 |
| 00063 | 6 | 270 | 00525 | 9 | 132, 424 | 00605 | 8 | 445 |
| 00064 | 3 | 105 | 00526 | 6 | 132, 424 | 00606 | 5 | 445 |
| 00065 | 0 | 105 | 00528 | 0 | 132, 424 | 00607 | 2 | 445 |
| 00067 | 4 | 105 | 00529 | 7 | 132, 424 | 00610 | 2 | 470, 481 |
| 00069 | 8 | 73, 304 | 00530 | 3 | 133, 425 | 00611 | 9 | 470, 481 |
| 00070 | 4 | 299 | 00531 | 0 | 133, 425 | 00612 | 6 | 470, 481 |
| 00071 | 1 | 303 | 00532 | 7 | 133, 425 | 00615 | 7 | 56, 410, 496 |
| 00074 | 2 | 301 | 00533 | 4 | 133, 425 | 00617 | 1 | 56, 410, 413 |
| 00075 | 9 | 101 | 00534 | 1 | 133, 425 | 00618 | 8 | 56, 410 |
| 00076 | 6 | 300 | 00535 | 8 | 133, 425 | 00619 | 5 | 56, 410 |
| 00078 | 0 | 302 | 00536 | 5 | 133, 425 | 00620 | 1 | 56, 410 |
| 00079 | 7 | 302 | 00537 | 2 | 133, 425 | 00621 | 8 | 56, 410 |
| 00081 | 0 | 101 | 00538 | 9 | 133, 425 | 00623 | 2 | 287 |
| 00082 | 7 | 101 | 00539 | 6 | 133, 425 | 00625 | 6 | 287 |
| 00084 | 1 | 101 | 00540 | 2 | 133, 425 | 00626 | 3 | 287 |
| 00085 | 8 | 101 | 00541 | 9 | 133, 425 | 00627 | 0 | 287 |
| 00087 | 2 | 101 | 00542 | 6 | 133, 425 | 00634 | 8 | 269, 416 |
| 00090 | 2 | 429 | 00543 | 3 | 133, 425 | 00636 | 2 | 64 |
| 00091 | 9 | 429 | 00547 | 1 | 131, 423 | 00637 | 9 | 65 |
| 00092 | 6 | 468 | 00548 | 8 | 131, 423 | 00650 | 8 | 351 |
| 00093 | 3 | 468 | 00549 | 5 | 131, 423 | 00652 | 2 | 105, 136 |
| 00094 | 0 | 468 | 00552 | 5 | 133, 425 | 00662 | 1 | 443 |
| 00098 | 8 | 468 | 00553 | 2 | 133, 425 | 00664 | 5 | 443 |
| 00099 | 5 | 468 | 00554 | 9 | 133, 425 | 00666 | 9 | 443 |
| 00106 | 0 | 469 | 00555 | 6 | 133, 425 | 00668 | 3 | 443 |
| 00110 | 7 | 468 | 00560 | 0 | 427 | 00670 | 6 | 443 |
| 00113 | 8 | 468 | 00561 | 7 | 292, 427 | 00671 | 3 | 440 |
| | | | 00562 | 4 | 427 | 00672 | 0 | 440 |
| | | | 00563 | 1 | 427 | 00673 | 7 | 440 |
| | | | 00564 | 8 | 427 | 00677 | 5 | 240 |
| | | | | | | 00685 | 0 | 447 |
| | | | | | | 00686 | 7 | 447 |
| | | | | | | 00687 | 4 | 447 |
| | | | | | | 00688 | 1 | 447 |
| | | | | | | 00691 | 1 | 240 |
| | | | | | | 00692 | 8 | 240 |
| | | | | | | 00693 | 5 | 240 |
| | | | | | | 00694 | 2 | 470 |
| | | | | | | 00695 | 9 | 470 |
| | | | | | | 00696 | 6 | 470 |
| | | | | | | 00697 | 3 | 470 |
| | | | | | | 00699 | 7 | 240, 453 |
| | | | | | | 00700 | 0 | 301 |
| | | | | | | 00711 | 6 | 440 |
| | | | | | | 00712 | 3 | 440 |
| | | | | | | 00713 | 0 | 440 |
| | | | | | | 00714 | 7 | 440 |
| | | | | | | 00715 | 4 | 440 |
| | | | | | | 00716 | 1 | 440 |
| | | | | | | 00721 | 5 | 440 |
| | | | | | | 00722 | 2 | 440 |
| | | | | | | 00723 | 9 | 440 |
| | | | | | | 00730 | 7 | 440 |
| | | | | | | 00740 | 6 | 462 |
| | | | | | | 00744 | 4 | 462 |
| | | | | | | 00745 | 1 | 462 |
| | | | | | | 00746 | 8 | 462 |
| | | | | | | 00747 | 5 | 462 |
| | | | | | | 00750 | 5 | 124, 247 |
| | | | | | | 00751 | 2 | 124, 247 |
| | | | | | | 00752 | 9 | 124, 247 |
| | | | | | | 00753 | 6 | 124, 247 |
| | | | | | | 00754 | 3 | 125, 248 |
| | | | | | | 00755 | 0 | 125, 248 |
| | | | | | | 00756 | 7 | 125, 248 |
| | | | | | | 00757 | 4 | 125, 248 |
| | | | | | | 00758 | 1 | 117 |
| | | | | | | 00759 | 8 | 117 |
| | | | | | | 00760 | 4 | 118 |
| | | | | | | 00761 | 1 | 125, 246 |
| | | | | | | 00765 | 9 | 269, 416 |
| | | | | | | 00766 | 6 | 267, 417 |
| | | | | | | 00768 | 0 | 267, 269, 416, 417 |
| | | | | | | 00771 | 0 | 464 |
| | | | | | | 00772 | 7 | 258, 465 |
| | | | | | | 00773 | 4 | 258 |
| | | | | | | 00774 | 1 | 258 |
| | | | | | | 00775 | 8 | 258 |
| | | | | | | 00776 | 5 | 258 |
| | | | | | | 00777 | 2 | 258 |
| | | | | | | 00778 | 9 | 258 |
| | | | | | | 00779 | 6 | 258, 465 |
| | | | | | | 00780 | 2 | 465 |
| | | | | | | 00781 | 9 | 258 |
| | | | | | | 00782 | 6 | 258 |
| | | | | | | 00783 | 3 | 258 |
| | | | | | | 00785 | 7 | 465 |
| | | | | | | 00790 | 1 | 119, 245 |
| | | | | | | 00791 | 8 | 119, 245 |
| | | | | | | 00792 | 5 | 119, 245 |
| | | | | | | 00793 | 2 | 119, 245 |
| | | | | | | 00794 | 9 | 69 |
| | | | | | | 00795 | 6 | 69 |
| | | | | | | 00796 | 3 | 69 |
| | | | | | | 00805 | 2 | 129 |
| | | | | | | 00806 | 9 | 89, 129 |
| | | | | | | 00807 | 6 | 129 |
| | | | | | | 00808 | 3 | 122, 249 |
| | | | | | | 00809 | 0 | 123 |
| | | | | | | 00810 | 6 | 120, 244 |
| | | | | | | 00811 | 3 | 120, 244 |
| | | | | | | 00812 | 0 | 120, 244 |
| | | | | | | 00813 | 7 | 120, 244 |
| | | | | | | 00814 | 4 | 120, 244 |
| | | | | | | 00816 | 8 | 129 |
| | | | | | | 00817 | 5 | 123 |
| | | | | | | 00818 | 2 | 122, 134, 288 |
| | | | | | | 00820 | 5 | 107 |
| | | | | | | 00821 | 2 | 107 |
| | | | | | | 00822 | 9 | 107 |
| | | | | | | 00825 | 0 | 107 |
| | | | | | | 00826 | 7 | 107 |
| | | | | | | 00827 | 4 | 104 |
| | | | | | | 00828 | 1 | 104 |
| | | | | | | 00830 | 4 | 94, 107 |
| | | | | | | 00831 | 1 | 442 |
| | | | | | | 00832 | 8 | 442 |
| | | | | | | 00833 | 5 | 442 |
| | | | | | | 00834 | 2 | 442 |
| | | | | | | 00835 | 9 | 125, 248 |
| | | | | | | 00840 | 3 | 454 |
| | | | | | | 00841 | 0 | 454 |
| | | | | | | 00842 | 7 | 454 |
| | | | | | | 00843 | 4 | 127, 241 |
| | | | | | | 00844 | 1 | 127, 241 |
| | | | | | | 00845 | 8 | 243 |
| | | | | | | 00846 | 5 | 129, 243 |
| | | | | | | 00864 | 9 | 128, 245 |
| | | | | | | 00867 | 0 | 121, 244 |
| | | | | | | 00868 | | |

| | | | | | | | | | | | | | | | | | |
|-------|---|---------------------------------------|----------|---|-------------|-------|---|-----------------|-------|---|-----------------------------|-------|---|------------------------------------|-------|---|-----------------------------|
| 01323 | 0 | 103 | 09091 | 0 | 35 | 10503 | 4 | 386 | 10708 | 3 | 42 | 10840 | 0 | 46 | 11044 | 1 | 75, 100, 166, 188, 324, 484 |
| 01324 | 7 | 103 | 09093 | 4 | 35 | 10504 | 1 | 386 | 10709 | 0 | 42 | 10849 | 3 | 36, 383 | 11048 | 9 | 100 |
| 01325 | 4 | 103 | 09094 | 1 | 35 | 10505 | 8 | 38, 387 | 10710 | 6 | 42 | 10850 | 9 | 46 | 11051 | 9 | 490 |
| 01332 | 2 | 103 | 09099 | 6 | 106 | 10506 | 5 | 240, 434 | 10711 | 3 | 42 | 10851 | 6 | 37, 39, 384 | 11052 | 6 | 490 |
| 01335 | 3 | 103 | 09100 | 9 | 34 | 10509 | 6 | 387 | 10712 | 0 | 42 | 10853 | 0 | 37, 384 | 11053 | 3 | 490 |
| 01338 | 4 | 103 | 09102 | 3 | 34 | 10510 | 2 | 387 | 10713 | 7 | 42 | 10855 | 4 | 38 | 11054 | 0 | 490 |
| 01348 | 3 | 103 | 09104 | 7 | 34 | 10511 | 9 | 387 | 10714 | 4 | 42 | 10859 | 2 | 46 | 11055 | 7 | 422, 492 |
| 01349 | 0 | 103 | 09200 | 6 | 34 | 10512 | 6 | 387 | 10715 | 1 | 42 | 10870 | 7 | 20, 45 | 11056 | 4 | 83, 186, 422, 492 |
| 01699 | 6 | 106, 271 | 09202 | 0 | 34 | 10513 | 3 | 386 | 10716 | 8 | 42 | 10871 | 4 | 20, 45 | 11065 | 6 | 100 |
| 01709 | 2 | 103 | 09204 | 4 | 34 | 10514 | 0 | 386 | 10717 | 5 | 42 | 10872 | 1 | 20, 45 | 11070 | 0 | 316, 318, 486 |
| 01710 | 8 | 103 | | | | 10515 | 7 | 386 | 10718 | 2 | 37, 38, 384 | 10873 | 8 | 20, 45 | 11071 | 7 | 316, 318, 486 |
| 01711 | 5 | 103 | 1 | | | 10516 | 4 | 386 | 10720 | 5 | 41 | 10887 | 5 | 19, 495 | 11072 | 4 | 316, 318, 486 |
| 01712 | 2 | 103 | 10316 | 0 | 267, 417 | 10517 | 1 | 386 | 10721 | 2 | 51 | 10889 | 9 | 495 | 11073 | 1 | 117, 486 |
| 01738 | 2 | 103 | 10318 | 4 | 416 | 10520 | 1 | 52 | 10722 | 9 | 51 | 10890 | 5 | 19, 495 | 11074 | 8 | 486 |
| 01748 | 1 | 103 | 10319 | 1 | 416 | 10525 | 6 | 387 | 10738 | 0 | 51 | 10907 | 0 | 46 | 11075 | 5 | 25, 28, 112, 117, 487 |
| 02038 | 2 | 296 | 10320 | 7 | 416 | 10526 | 3 | 387 | 10739 | 7 | 51 | 10910 | 0 | 49 | 11100 | 4 | 29, 100 |
| 02039 | 9 | 296 | 10321 | 4 | 269, 416 | 10527 | 0 | 387 | 10741 | 0 | 51 | 10911 | 7 | 49 | 11101 | 1 | 29, 30, 34, 496 |
| 02310 | 9 | 102 | 10322 | 1 | 415 | 10528 | 7 | 387 | 10742 | 7 | 51 | 10912 | 4 | 49 | 11110 | 3 | 100 |
| 02311 | 6 | 102 | 10323 | 8 | 415 | 10529 | 4 | 387 | 10748 | 9 | 53 | 10913 | 1 | 49 | 11118 | 9 | 15 |
| 02312 | 3 | 102 | 10325 | 2 | 415 | 10530 | 0 | 387 | 10749 | 6 | 53 | 10914 | 8 | 49 | 11119 | 6 | 15, 204 |
| 03038 | 1 | 274 | 10326 | 9 | 415 | 10531 | 7 | 387 | 10750 | 2 | 45 | 10915 | 5 | 47 | 11150 | 9 | 99 |
| 03039 | 8 | 274 | 10327 | 6 | 415 | 10532 | 4 | 387 | 10756 | 4 | 46 | 10916 | 2 | 47 | 11155 | 4 | 99 |
| 03098 | 5 | 274 | 10328 | 3 | 414 | 10533 | 1 | 387 | 10757 | 1 | 46 | 10917 | 9 | 47 | 11244 | 5 | 348 |
| 03099 | 2 | 274 | 10329 | 0 | 414 | 10534 | 8 | 387 | 10758 | 8 | 46 | 10921 | 6 | 48 | 11295 | 7 | 99 |
| 03622 | 2 | 97, 217 | 10330 | 6 | 414 | 10535 | 5 | 387 | 10759 | 5 | 46 | 10922 | 3 | 48 | 11300 | 8 | 99 |
| 03623 | 9 | 97, 217 | 10331 | 3 | 414 | 10536 | 2 | 387 | 10762 | 5 | 50 | 10923 | 0 | 48 | 11305 | 3 | 99, 484 |
| 03824 | 0 | 101 | 10332 | 0 | 414 | 10560 | 7 | 385 | 10764 | 9 | 50 | 10924 | 7 | 48 | 11442 | 5 | 95 |
| 04010 | 6 | 275 | 10334 | 4 | 414 | 10561 | 4 | 385 | 10766 | 3 | 50 | 10925 | 4 | 48 | 11444 | 9 | 95 |
| 04011 | 3 | 275 | 10335 | 1 | 414 | 10562 | 1 | 385 | 10769 | 4 | 53 | 10926 | 1 | 48 | 11446 | 3 | 95 |
| 04015 | 1 | 275 | 10336 | 8 | 414 | 10563 | 8 | 385 | 10770 | 0 | 52 | 10927 | 8 | 48 | 11455 | 5 | 95 |
| 04017 | 5 | 275 | 10350 | 4 | 414 | 10564 | 5 | 385 | 10771 | 7 | 53 | 10928 | 5 | 48 | 11495 | 1 | 78, 80 |
| 04020 | 5 | 274 | 10351 | 1 | 414 | 10565 | 2 | 385 | 10775 | 5 | 53 | 10990 | 2 | 57, 419 | 11496 | 8 | 78 |
| 04021 | 2 | 274 | 10352 | 8 | 49 | 10566 | 9 | 385 | 10776 | 2 | 53 | 10991 | 9 | 57, 419 | 11497 | 5 | 78 |
| 04446 | 3 | 293 | 10353 | 5 | 49 | 10567 | 6 | 385 | 10777 | 9 | 19, 31, 32, 33, 42, 496 | 10992 | 6 | 57, 419 | 11498 | 2 | 78 |
| 06401 | 0 | 105, 492 | 10354 | 2 | 49 | 10568 | 3 | 385 | 10778 | 6 | 62 | 10993 | 3 | 58 | 11499 | 9 | 78 |
| 06501 | 7 | 491 | 10355 | 9 | 415 | 10569 | 0 | 385 | 10781 | 6 | 496 | 10994 | 0 | 58 | 11503 | 3 | 29 |
| 06503 | 1 | 105 | 10360 | 3 | 415 | 10570 | 6 | 385 | 10782 | 3 | 28, 112, 496 | 10995 | 7 | 57, 419 | 11505 | 7 | 29 |
| 06504 | 8 | 491 | 10361 | 0 | 415 | 10571 | 3 | 385 | 10788 | 5 | 41 | 10996 | 4 | 57, 419 | 11510 | 1 | 28 |
| 06506 | 2 | 491 | 10362 | 7 | 415 | 10572 | 0 | 385 | 10789 | 2 | 41 | 11000 | 7 | 100 | 11512 | 5 | 29 |
| 06510 | 9 | 105, 122, 134, 217, 288, 491 | 10400 | 6 | 37, 384 | 10573 | 7 | 385 | 10791 | 5 | 25, 26, 27, 28, 29, 30, 496 | 11008 | 3 | 17, 26, 29, 315, 487 | 11514 | 9 | 28 |
| 06512 | 3 | 75, 122, 129, 217, 491 | 10403 | 7 | 37, 384 | 10574 | 4 | 385 | 10792 | 2 | 51 | 11010 | 6 | 25, 26, 28, 29, 170, 183, 315, 487 | 11522 | 4 | 81 |
| 06515 | 4 | 491 | 10404 | 4 | 37, 384 | 10575 | 1 | 385 | 10795 | 3 | 41 | 11013 | 7 | 486 | 11523 | 1 | 80, 81 |
| 06517 | 8 | 491 | 10405 | 1 | 37, 384 | 10576 | 8 | 385 | 10796 | 0 | 41 | 11016 | 8 | 129, 487 | 11524 | 8 | 80 |
| 06519 | 2 | 129, 135, 180, 289, 290, 488 | 10409 | 9 | 37, 384 | 10577 | 5 | 385 | 10800 | 4 | 41 | 11018 | 2 | 17, 315, 487 | 11526 | 2 | 80 |
| 06520 | 8 | 75, 122, 129, 134, 135, 180, 288, 289 | 10410 | 5 | 37, 384 | 10578 | 2 | 385 | 10801 | 1 | 42 | 11020 | 5 | 100 | 11527 | 9 | 80 |
| 06521 | 5 | 129, 135, 180, 289, 290, 489 | 10411 | 2 | 37, 384 | 10579 | 9 | 385 | 10802 | 8 | 43 | 11021 | 2 | 170, 183, 485 | 11528 | 6 | 81 |
| 06525 | 3 | 180, 290, 489 | 10415 | 0 | 38 | 10585 | 0 | 385 | 10803 | 5 | 42 | 11022 | 9 | 324, 485 | 11529 | 3 | 81 |
| 06701 | 1 | 105, 492 | 10416 | 7 | 38 | 10586 | 7 | 385 | 10804 | 2 | 42 | 11026 | 7 | 316, 485 | 11533 | 0 | 30 |
| 08201 | 4 | 101 | 10417 | 4 | 38 | 10587 | 4 | 385 | 10807 | 3 | 42 | 11027 | 4 | 170, 316, 318, 324, 485 | 11538 | 5 | 30 |
| 09010 | 1 | 102 | 10418 | 1 | 38 | 10588 | 1 | 385 | 10808 | 0 | 42 | 11028 | 1 | 316, 485 | 11540 | 8 | 26 |
| 09013 | 2 | 102, 487 | 10422 | 8 | 39 | 10589 | 8 | 385 | 10809 | 7 | 42 | 11032 | 8 | 100 | 11541 | 5 | 26 |
| 09023 | 1 | 488 | 10424 | 2 | 39, 40 | 10608 | 6 | 42 | 10812 | 7 | 42 | 11038 | 0 | 100 | 11542 | 2 | 27 |
| 09080 | 4 | 106 | 10426 | 6 | 39, 40 | 10661 | 1 | 19, 31, 32, 496 | 10814 | 1 | 42 | 11040 | 3 | 100 | 11543 | 9 | 27 |
| 09082 | 8 | 30 | 10427 | 3 | 40 | 10663 | 5 | 45 | 10825 | 7 | 46 | 11041 | 0 | 100, 166, 170, 188, 484 | 11546 | 0 | 25 |
| 09083 | 5 | 30 | 10430 | 3 | 39 | 10668 | 0 | 62 | 10830 | 1 | 45 | 11042 | 7 | 100, 166, 183, 188, 318, 324 | 11547 | 7 | 25 |
| 09090 | 3 | 35 | 10435 | 8 | 40 | 10690 | 1 | 52, 118 | 10833 | 2 | 45 | 11043 | 4 | 100, 166, 188, 484 | 11555 | 2 | 316 |
| | | | 10440 | 2 | 44 | 10691 | 8 | 52 | 10836 | 3 | 20, 44 | | | | 11556 | 9 | 93 |
| | | | 10445 | 1 | 36, 383 | 10700 | 7 | 41 | 10837 | 0 | 20, 44 | | | | 11557 | 6 | 84 |
| | | | 10451 | 8 | 36, 383 | 10701 | 4 | 42 | 10838 | 7 | 20, 44 | | | | 11558 | 3 | 84 |
| | | | 10500 | 3 | 386 | 10703 | 8 | 42 | 10839 | 4 | 20, 44 | | | | | | |
| | | | 10501 | 0 | 39, 40, 386 | 10704 | 5 | 42 | | | | | | | | | |
| | | | 10502 | 7 | 386 | 10707 | 6 | 42 | | | | | | | | | |

| | | | | | | | | | | | | | | | | | |
|-------|---|---------------|-------|---|---------------------|-------|---|---------------------------------------|-------|---|----------|-------|---|---------------------------|----------|---|---------------|
| 11563 | 7 | 58 | 11780 | 8 | 141 | 11973 | 4 | 62 | 12396 | 0 | 337 | 15348 | 6 | 154 | 2 | | |
| 11572 | 9 | 93 | 11781 | 5 | 141 | 11974 | 1 | 62 | 12397 | 7 | 335, 337 | 15350 | 9 | 490 | 23642 | 4 | 105 |
| 11573 | 6 | 93 | 11795 | 2 | 79 | 11975 | 8 | 60 | 12398 | 4 | 337 | 15351 | 6 | 490 | | | |
| 11574 | 3 | 58 | 11805 | 8 | 60 | 11977 | 2 | 364 | 12399 | 1 | 337 | 15400 | 1 | 156 | 3 | | |
| 11575 | 0 | 58 | 11807 | 2 | 60 | 11978 | 9 | 360 | 12403 | 5 | 338 | 15401 | 8 | 156 | 30000 | 2 | 74 |
| 11576 | 7 | 58 | 11810 | 2 | 32 | 11979 | 6 | 364 | 12404 | 2 | 336 | 15402 | 5 | 156 | 30001 | 9 | 74 |
| 11595 | 8 | 77, 81 | 11811 | 9 | 31, 32 | 11980 | 2 | 79 | 12483 | 7 | 338 | 15403 | 2 | 156 | 30002 | 6 | 74 |
| 11596 | 5 | 77 | 11812 | 6 | 31 | 11981 | 9 | 79 | 12484 | 4 | 338 | 15404 | 9 | 156 | 30020 | 0 | 74 |
| 11597 | 2 | 77 | 11813 | 3 | 31 | 11986 | 4 | 79 | 12879 | 8 | 304, 495 | 15416 | 2 | 156 | 30021 | 7 | 74 |
| 11598 | 9 | 77 | 11815 | 7 | 32 | 11998 | 7 | 138, 295, 367 | 12940 | 5 | 14 | 15417 | 9 | 156 | 30045 | 3 | 467 |
| 11599 | 6 | 77 | 11816 | 4 | 31, 32 | 11999 | 4 | 138, 295, 367 | 12941 | 2 | 14 | 15418 | 6 | 156 | 30046 | 0 | 467 |
| 11607 | 8 | 93 | 11817 | 1 | 31 | 12000 | 6 | 100 | 12990 | 0 | 404 | 15419 | 3 | 156 | 30047 | 7 | 467 |
| 11616 | 0 | 24 | 11818 | 8 | 31 | 12008 | 2 | 487 | 13122 | 4 | 104 | 15420 | 9 | 156 | 30048 | 4 | 467 |
| 11617 | 7 | 24 | 11840 | 9 | 59 | 12010 | 5 | 487 | 13377 | 8 | 469 | 15421 | 6 | 156 | 30049 | 1 | 467 |
| 11619 | 1 | 112 | 11841 | 6 | 59 | 12065 | 5 | 100 | 13378 | 5 | 469 | 15424 | 7 | 156 | 30050 | 7 | 19 |
| 11620 | 7 | 22, 330 | 11845 | 4 | 33 | 12100 | 3 | 100 | 13379 | 2 | 469 | 15425 | 4 | 156 | 30052 | 1 | 19 |
| 11621 | 4 | 22, 330 | 11846 | 1 | 31, 32 | 12225 | 3 | 345 | 13380 | 8 | 111, 251 | 15449 | 0 | 156 | 30057 | 6 | 467 |
| 11622 | 1 | 23, 331 | 11847 | 8 | 32 | 12232 | 1 | 346 | 13382 | 2 | 104 | 15450 | 6 | 156 | 30058 | 3 | 468 |
| 11623 | 8 | 22, 330 | 11848 | 5 | 31, 32 | 12233 | 8 | 344 | 13385 | 3 | 104 | 15451 | 3 | 156 | 30059 | 0 | 467 |
| 11625 | 2 | 273 | 11849 | 2 | 32 | 12235 | 2 | 345 | 13622 | 9 | 104 | 15452 | 0 | 156 | 30061 | 3 | 467 |
| 11626 | 9 | 22, 330 | 11859 | 1 | 495 | 12236 | 9 | 344 | 13940 | 4 | 14 | 15453 | 7 | 156 | 30062 | 0 | 467 |
| 11627 | 6 | 22, 330 | 11865 | 2 | 78, 495 | 12243 | 7 | 348 | 13941 | 1 | 14 | 15454 | 4 | 156 | 30063 | 7 | 467 |
| 11628 | 3 | 23, 331 | 11866 | 9 | 495 | 12244 | 4 | 348 | 13955 | 8 | 15 | 15455 | 1 | 156 | 30065 | 1 | 369, 471 |
| 11629 | 0 | 22, 330 | 11868 | 3 | 31, 32, 78, 495 | 12245 | 1 | 344 | 13965 | 7 | 61 | 15456 | 8 | 156 | 30066 | 8 | 369, 471 |
| 11645 | 0 | 28, 112 | 11875 | 1 | 33, 77, 495 | 12249 | 9 | 343, 344 | 13966 | 4 | 71 | 15457 | 5 | 156 | 30067 | 5 | 369, 471 |
| 11647 | 4 | 141, 272 | 11878 | 2 | 31, 32, 33, 77, 495 | 12270 | 3 | 76, 341 | 13980 | 0 | 19 | 15458 | 2 | 156 | 30068 | 2 | 369, 471 |
| 11648 | 1 | 141, 272 | 11879 | 9 | 304, 495 | 12271 | 0 | 76, 341 | 13981 | 7 | 19 | 15460 | 5 | 156 | 30069 | 9 | 369, 471 |
| 11649 | 8 | 272 | 11881 | 2 | 474 | 12272 | 7 | 76, 341 | 13987 | 9 | 21, 61 | 15461 | 2 | 156 | 30070 | 5 | 369, 471 |
| 11650 | 4 | 273 | 11882 | 2 | 474 | 12285 | 7 | 349 | 13990 | 9 | 18 | 15462 | 9 | 156 | 30071 | 2 | 369, 471 |
| 11651 | 1 | 273 | 11884 | 3 | 65 | 12287 | 1 | 47, 348, 349 | 13995 | 4 | 21 | 15467 | 4 | 156 | 30075 | 0 | 369, 470 |
| 11671 | 9 | 47, 348 | 11885 | 0 | 65 | 12290 | 1 | 350 | 14940 | 3 | 14 | 15473 | 5 | 157 | 30076 | 7 | 369, 470 |
| 11672 | 6 | 47, 348 | 11887 | 4 | 92 | 12291 | 8 | 337, 338, 349 | 14941 | 0 | 14 | 15474 | 2 | 157 | 30077 | 4 | 369, 470 |
| 11675 | 7 | 344 | 11888 | 1 | 92 | 12292 | 5 | 350 | 14953 | 3 | 17 | 15475 | 9 | 157 | 30078 | 1 | 369, 470 |
| 11683 | 2 | 350 | 11889 | 8 | 92 | 12294 | 9 | 350 | 14954 | 0 | 17 | 15477 | 3 | 157 | 30108 | 5 | 293, 426 |
| 11705 | 1 | 52, 118 | 11891 | 1 | 92 | 12295 | 6 | 76, 334, 336, 337, 338, 340, 341, 349 | 14956 | 4 | 17 | 15485 | 8 | 157 | 30110 | 8 | 293, 426 |
| 11706 | 8 | 52, 118 | 11901 | 7 | 346 | | | | 14965 | 6 | 61 | 15486 | 5 | 157 | 30111 | 5 | 109, 421 |
| 11711 | 2 | 70 | 11910 | 9 | 346 | | | | 14966 | 3 | 71 | 15501 | 5 | 157 | 30112 | 2 | 109, 421 |
| 11712 | 9 | 70 | 11915 | 4 | 345 | 12296 | 3 | 336, 349 | 14970 | 0 | 16 | 15502 | 2 | 157 | 30113 | 9 | 109, 421 |
| 11713 | 6 | 70 | 11916 | 1 | 345 | 12299 | 4 | 349 | 14980 | 9 | 19 | 15503 | 9 | 91, 157 | 30114 | 6 | 110, 422 |
| 11714 | 3 | 70 | 11917 | 8 | 345 | 12300 | 7 | 343 | 14981 | 6 | 19 | 15504 | 6 | 157 | 30115 | 3 | 109, 421 |
| 11715 | 0 | 23, 331 | 11921 | 5 | 294 | 12310 | 6 | 348 | 14987 | 8 | 21, 61 | 15505 | 3 | 157 | 30116 | 0 | 109, 421 |
| 11716 | 7 | 23, 331 | 11922 | 2 | 294 | 12322 | 9 | 339 | 14990 | 8 | 18 | 15506 | 0 | 76, 91, 157, 341 | 30117 | 7 | 109, 421 |
| 11717 | 4 | 23, 331 | 11930 | 7 | 296 | 12323 | 6 | 339 | 14995 | 3 | 21 | 15513 | 8 | 98, 157 | 30118 | 4 | 110, 421 |
| 11718 | 1 | 23, 331 | 11931 | 4 | 296 | 12324 | 3 | 340 | 15100 | 0 | 154 | 15514 | 5 | 98, 157 | 30119 | 1 | 110, 421 |
| 11720 | 4 | 139 | 11940 | 6 | 368 | 12325 | 0 | 340 | 15101 | 7 | 154 | 15514 | 5 | 98, 157 | 30120 | 7 | 110, 210 |
| 11721 | 1 | 22, 330 | 11945 | 1 | 365 | 12329 | 8 | 342 | 15110 | 9 | 154 | 15620 | 3 | 75 | 30121 | 4 | 110, 210 |
| 11722 | 8 | 22, 330 | 11946 | 8 | 365 | 12330 | 4 | 342 | 15111 | 6 | 154 | 15621 | 0 | 75 | 30126 | 9 | 110, 422 |
| 11723 | 5 | 22, 330 | 11947 | 5 | 365 | 12335 | 9 | 342 | 15112 | 3 | 154 | 15622 | 7 | 75 | 30130 | 6 | 111, 251, 420 |
| 11724 | 2 | 22, 330 | 11948 | 2 | 137, 366 | 12336 | 6 | 342 | 15113 | 0 | 154 | 15623 | 4 | 75 | 30131 | 3 | 111, 251, 420 |
| 11726 | 6 | 246, 273 | 11949 | 9 | 137, 366 | 12337 | 3 | 342 | 15116 | 1 | 154 | 15921 | 1 | 270 | 30132 | 0 | 111, 251, 420 |
| 11727 | 3 | 128, 246, 273 | 11950 | 5 | 368 | 12338 | 0 | 342 | 15200 | 7 | 154 | 15925 | 9 | 270 | 30133 | 7 | 111, 251, 420 |
| 11730 | 3 | 139 | 11951 | 2 | 137, 366 | 12350 | 2 | 343 | 15201 | 4 | 154 | 15926 | 6 | 270 | 30134 | 4 | 111, 251 |
| 11740 | 2 | 68 | 11952 | 9 | 137, 366 | 12352 | 6 | 335 | 15215 | 1 | 154 | 17910 | 3 | 15 | 30140 | 5 | 109, 251, 420 |
| 11762 | 4 | 140 | 11954 | 3 | 138, 367 | 12353 | 3 | 335 | 15216 | 8 | 154 | 17922 | 6 | 15 | 30141 | 2 | 109, 251, 420 |
| 11763 | 1 | 140 | 11955 | 0 | 138, 367 | 12354 | 0 | 335 | 15217 | 5 | 154 | 18121 | 2 | 492 | 30142 | 9 | 109, 251, 420 |
| 11765 | 5 | 140 | 11960 | 4 | 138, 367 | 12360 | 1 | 345 | 15320 | 2 | 157, 328 | 18380 | 3 | 488 | 30148 | 1 | 109, 422 |
| 11767 | 9 | 139 | 11965 | 9 | 137, 366 | 12366 | 3 | 335, 338 | 15322 | 6 | 157, 328 | 18387 | 2 | 27, 315, 488 | 30149 | 8 | 109, 422 |
| 11768 | 6 | 139 | 11966 | 6 | 137, 312, 366 | 12370 | 0 | 335 | 15324 | 0 | 157, 328 | 18388 | 9 | 27, 29, 30, 217, 315, 488 | 30200 | 6 | 326 |
| 11770 | 9 | 140 | 11969 | 7 | 92 | 12371 | 7 | 335 | 15326 | 4 | 328 | 18389 | 6 | 16, 315 | 30206 | 8 | 327 |
| 11771 | 6 | 140 | 11970 | 3 | 60 | 12372 | 4 | 335 | 15331 | 8 | 328 | 18621 | 7 | 492 | 30207 | 5 | 327 |
| 11775 | 4 | 58 | 11971 | 0 | 62 | 12372 | 4 | 335 | 15332 | 5 | 328 | | | | 30208 | 2 | 327 |
| 11776 | 1 | 58 | 11972 | 7 | 62 | 12393 | 9 | 338 | 15334 | 9 | 328 | | | | 30210 | 5 | 326 |
| 11778 | 5 | 140 | | | | 12394 | 6 | 336 | 15335 | 6 | 328 | | | | 30220 | 4 | 326 |

| | | | | | | | | | | | | | | | | | |
|-------|---|----------|-------|---|-------------------------|-------|---|---------|-------|---|----------|-------|---|---------|-------|---|---------------|
| 30230 | 3 | 326 | 30443 | 7 | 320 | 35730 | 3 | 292 | 36124 | 9 | 381 | 40223 | 2 | 312 | 40445 | 8 | 265 |
| 30240 | 2 | 326 | 30444 | 4 | 320 | 35734 | 1 | 292 | 36125 | 6 | 228, 379 | 40224 | 9 | 313 | 40446 | 5 | 265 |
| 30250 | 1 | 326 | 30445 | 1 | 320 | 35912 | 3 | 293 | 36126 | 3 | 379 | 40225 | 6 | 312 | 40450 | 2 | 261 |
| 30260 | 0 | 481 | 30446 | 8 | 320 | 36003 | 7 | 373 | 36127 | 0 | 228, 379 | 40226 | 3 | 313 | 40453 | 3 | 265 |
| 30263 | 1 | 481 | 30447 | 5 | 320 | 36004 | 4 | 373 | 36130 | 0 | 54, 382 | 40227 | 0 | 312 | 40454 | 0 | 265 |
| 30270 | 9 | 326 | 30450 | 5 | 320 | 36010 | 5 | 395 | 36233 | 8 | 292 | 40228 | 7 | 313 | 40455 | 7 | 262 |
| 30276 | 1 | 327 | 30451 | 2 | 320 | 36011 | 2 | 395 | 36323 | 6 | 292 | 40229 | 4 | 312 | 40457 | 1 | 262 |
| 30277 | 8 | 327 | 33206 | 5 | 71 | 36013 | 6 | 406 | 38202 | 2 | 101 | 40230 | 0 | 313 | 40458 | 8 | 262 |
| 30279 | 2 | 319 | 33207 | 2 | 71 | 36015 | 0 | 405 | | | | 40240 | 9 | 313 | 40460 | 1 | 262 |
| 30280 | 8 | 319 | 33208 | 9 | 85 | 36017 | 4 | 406 | 4 | | | 40242 | 3 | 313 | 40461 | 8 | 262, 263 |
| 30281 | 5 | 319 | 33209 | 6 | 85 | 36020 | 4 | 373 | 40007 | 8 | 294, 317 | 40243 | 0 | 312 | 40462 | 5 | 262, 263 |
| 30282 | 2 | 319 | 33210 | 2 | 84 | 36021 | 1 | 373 | 40009 | 2 | 294, 317 | 40244 | 7 | 313 | 40463 | 2 | 262 |
| 30283 | 9 | 319 | 33211 | 9 | 86 | 36025 | 9 | 372 | 40010 | 8 | 294, 317 | 40245 | 4 | 312 | 40464 | 9 | 262 |
| 30285 | 3 | 319 | 33212 | 6 | 86 | 36026 | 6 | 372 | 40011 | 5 | 294, 317 | 40246 | 1 | 313 | 40470 | 0 | 263 |
| 30286 | 0 | 319 | 33214 | 0 | 86 | 36028 | 0 | 372 | 40012 | 2 | 294, 317 | 40247 | 8 | 312 | 40472 | 4 | 263 |
| 30299 | 0 | 311 | 33215 | 7 | 86 | 36030 | 3 | 379 | 40013 | 9 | 294, 317 | 40249 | 2 | 312 | 40474 | 8 | 263 |
| 30310 | 2 | 326 | 33216 | 4 | 86 | 36032 | 7 | 380 | 40110 | 5 | 102 | 40260 | 7 | 313 | 40476 | 2 | 263 |
| 30325 | 6 | 87 | 33217 | 1 | 86 | 36033 | 4 | 405 | 40115 | 0 | 102 | 40262 | 1 | 313 | 40478 | 6 | 263 |
| 30331 | 7 | 23, 331 | 33219 | 5 | 86 | 36034 | 1 | 380 | 40130 | 3 | 294, 317 | 40263 | 8 | 313 | 40480 | 9 | 263 |
| 30332 | 4 | 374 | 33220 | 1 | 86 | 36037 | 2 | 405 | 40131 | 0 | 294, 317 | 40264 | 5 | 313 | 40482 | 3 | 264 |
| 30333 | 1 | 382 | 33232 | 4 | 93 | 36038 | 9 | 379 | 40132 | 7 | 314 | 40270 | 6 | 313 | 40485 | 4 | 265 |
| 30334 | 8 | 82 | 33238 | 6 | 87 | 36044 | 0 | 376 | 40135 | 8 | 314 | 40272 | 0 | 313 | 40486 | 1 | 268, 418 |
| 30335 | 5 | 85 | 33246 | 1 | 79, 286 | 36045 | 7 | 376 | 40137 | 2 | 314 | 40274 | 4 | 313 | 40487 | 8 | 268, 418 |
| 30336 | 2 | 83 | 33248 | 5 | 87 | 36046 | 4 | 376 | 40139 | 6 | 314 | 40276 | 8 | 313 | 40488 | 5 | 269, 416 |
| 30337 | 9 | 83, 324 | 33249 | 2 | 96 | 36047 | 1 | 376 | 40140 | 2 | 314 | 40290 | 4 | 16, 312 | 40490 | 8 | 268, 418 |
| 30338 | 6 | 83 | 33250 | 8 | 96 | 36048 | 8 | 378 | 40144 | 0 | 93, 314 | 40291 | 1 | 16, 312 | 40494 | 6 | 268, 418 |
| 30339 | 3 | 82 | 33251 | 5 | 96 | 36052 | 5 | 378 | 40148 | 8 | 314 | 40292 | 8 | 16, 312 | 40498 | 4 | 418 |
| 30340 | 9 | 321 | 33252 | 2 | 96, 184 | 36053 | 2 | 378 | 40149 | 5 | 315 | 40293 | 5 | 16, 312 | 40499 | 1 | 418 |
| 30341 | 6 | 321 | 33255 | 3 | 74, 98 | 36054 | 9 | 378 | 40150 | 1 | 315 | 40294 | 2 | 16, 315 | 40500 | 4 | 257 |
| 30345 | 4 | 321 | 33256 | 0 | 74, 98 | 36055 | 6 | 373 | 40152 | 5 | 314 | 40295 | 9 | 16, 315 | 40501 | 1 | 257 |
| 30346 | 1 | 321 | 33260 | 7 | 96 | 36056 | 3 | 378 | 40153 | 2 | 315 | 40296 | 6 | 311 | 40503 | 5 | 257 |
| 30347 | 8 | 321 | 33261 | 4 | 96 | 36057 | 0 | 377 | 40159 | 4 | 314 | 40297 | 3 | 311 | 40504 | 2 | 126, 257 |
| 30348 | 5 | 321 | 33262 | 1 | 96 | 36062 | 4 | 380 | 40179 | 2 | 317 | 40299 | 7 | 311 | 40505 | 9 | 257 |
| 30350 | 8 | 321 | 33269 | 0 | 69, 96 | 36063 | 1 | 380 | 40182 | 2 | 317 | 40300 | 0 | 265 | 40506 | 6 | 268, 417 |
| 30351 | 5 | 321 | 33270 | 6 | 69, 96 | 36066 | 2 | 373 | 40185 | 3 | 236 | 40310 | 9 | 261 | 40507 | 3 | 257 |
| 30355 | 3 | 320 | 33271 | 3 | 69, 96 | 36068 | 6 | 374 | 40186 | 0 | 106, 233 | 40311 | 6 | 261 | 40508 | 0 | 267, 417 |
| 30356 | 0 | 126, 320 | 33272 | 0 | 96 | 36069 | 3 | 374 | 40187 | 7 | 106, 233 | 40312 | 3 | 261 | 40509 | 7 | 267, 417 |
| 30357 | 7 | 322, 434 | 33273 | 7 | 96 | 36074 | 7 | 379 | 40188 | 4 | 106, 233 | 40313 | 0 | 261 | 40510 | 3 | 268, 418 |
| 30358 | 4 | 322, 434 | 33280 | 5 | 98 | 36075 | 4 | 382 | 40189 | 1 | 327 | 40320 | 8 | 261 | 40511 | 0 | 266 |
| 30360 | 7 | 321 | 33281 | 2 | 98 | 36077 | 8 | 376 | 40189 | 1 | 327 | 40330 | 7 | 264 | 40516 | 5 | 240, 393 |
| 30361 | 4 | 321 | 33282 | 9 | 97, 184, 216, 287 | 36087 | 7 | 377 | 40190 | 7 | 327 | 40331 | 4 | 264 | 40517 | 2 | 240, 393 |
| 30370 | 6 | 321 | 33288 | 1 | 94 | 36090 | 7 | 381 | 40192 | 1 | 314 | 40333 | 8 | 264 | 40535 | 6 | 253 |
| 30371 | 3 | 321 | 33292 | 8 | 135, 289 | 36095 | 2 | 55, 377 | 40193 | 8 | 314 | 40404 | 5 | 272 | 40536 | 3 | 253 |
| 30380 | 5 | 322 | 33293 | 5 | 135, 289 | 36096 | 9 | 55, 377 | 40194 | 5 | 314 | 40405 | 2 | 272 | 40537 | 0 | 253 |
| 30385 | 0 | 322 | 33294 | 2 | 135, 136, 289, 290, 489 | 36099 | 0 | 381 | 40195 | 2 | 314 | 40410 | 6 | 260 | 40538 | 7 | 254 |
| 30390 | 4 | 322 | 33295 | 9 | 135, 136, 289, 290, 489 | 36100 | 3 | 55, 77 | 40196 | 9 | 314 | 40411 | 3 | 260 | 40539 | 4 | 254 |
| 30395 | 9 | 322 | | | | 36101 | 0 | 55, 377 | 40198 | 3 | 316 | 40412 | 0 | 260 | 40540 | 0 | 254 |
| 30396 | 6 | 322 | | | | 36102 | 7 | 404 | 40200 | 3 | 291 | 40413 | 7 | 260 | 40541 | 7 | 255 |
| 30410 | 9 | 324 | | | | 36103 | 4 | 404 | 40201 | 0 | 291 | 40414 | 4 | 266 | 40544 | 8 | 257 |
| 30411 | 6 | 324 | | | | 36104 | 1 | 381 | 40202 | 7 | 291 | 40415 | 1 | 261 | 40545 | 5 | 257, 265 |
| 30412 | 3 | 324 | 33296 | 6 | 135, 289 | 36105 | 8 | 381 | 40203 | 4 | 291 | 40416 | 8 | 256 | 40546 | 2 | 253 |
| 30413 | 0 | 324 | 33297 | 3 | 135, 289 | 36106 | 5 | 55, 375 | 40204 | 1 | 291 | 40417 | 5 | 256 | 40547 | 9 | 253 |
| 30414 | 7 | 324 | 33300 | 0 | 66 | 36107 | 2 | 55, 375 | 40205 | 8 | 291 | 40418 | 2 | 256 | 40548 | 6 | 253 |
| 30415 | 4 | 324 | 33301 | 7 | 67 | 36108 | 9 | 55, 375 | 40206 | 5 | 291 | 40424 | 3 | 264 | 40549 | 3 | 255 |
| 30416 | 1 | 324 | 33302 | 4 | 66 | 36109 | 6 | 55, 375 | 40207 | 2 | 292 | 40425 | 0 | 303 | 40550 | 9 | 255 |
| 30420 | 8 | 325 | 33303 | 1 | 67 | 36111 | 9 | 55, 375 | 40208 | 9 | 291 | 40435 | 9 | 259 | 40551 | 6 | 256 |
| 30421 | 5 | 325 | 33304 | 8 | 66, 67, 97 | 36112 | 6 | 55, 375 | 40210 | 2 | 318 | 40436 | 6 | 259 | 40552 | 3 | 256 |
| 30422 | 2 | 325 | 33305 | 5 | 97, 118 | 36115 | 7 | 372 | 40211 | 9 | 318 | 40437 | 3 | 259 | 40553 | 0 | 255 |
| 30423 | 9 | 325 | 35065 | 6 | 350 | 36116 | 4 | 374 | 40212 | 6 | 318 | 40438 | 0 | 259 | 40554 | 7 | 255 |
| 30424 | 6 | 325 | 35343 | 5 | 350 | 36120 | 1 | 375 | 40214 | 0 | 318 | 40439 | 7 | 259 | 40555 | 4 | 126, 253, 266 |
| 30440 | 6 | 320 | 35711 | 2 | 293 | 36121 | 8 | 375 | 40216 | 4 | 318 | 40440 | 3 | 261 | 40556 | 1 | 126, 253, 266 |
| 30441 | 3 | 320 | 35716 | 7 | 52, 118, 293 | 36122 | 5 | 381 | 40220 | 1 | 313 | 40441 | 0 | 261 | 40557 | 8 | 254 |
| 30442 | 0 | 320 | 35720 | 4 | 292 | 36123 | 2 | 381 | 40222 | 5 | 313 | 40442 | 7 | 259 | 40558 | 5 | 254 |

| | | | | | | | | | | | | | | | | | |
|-------|---|---------------------|-------|---|---------------------------------|----------|---|-----|----------|---|-------------|-------|---|---------|----------|---|---------|
| 40570 | 7 | 252 | 40666 | 7 | 279 | 40768 | 8 | 239 | 60042 | 3 | 276 | 71001 | 6 | 451,474 | 74708 | 1 | 465 |
| 40571 | 4 | 252 | 40667 | 4 | 270,279 | | | | 60044 | 7 | 278 | 71002 | 3 | 451,474 | 74721 | 0 | 463 |
| 40572 | 1 | 252 | 40668 | 1 | 270,279 | 5 | | | 60045 | 4 | 278 | 71003 | 0 | 451,474 | 74722 | 7 | 463 |
| 40573 | 8 | 252 | 40669 | 8 | 279 | 50002 | 0 | 84 | 60046 | 1 | 278 | 71004 | 7 | 451,474 | 74731 | 9 | 466 |
| 40574 | 5 | 252 | 40670 | 4 | 111,114, 126,236, 251,420 | 50205 | 5 | 309 | 60270 | 0 | 102 | 71005 | 4 | 451,474 | 74750 | 0 | 418 |
| 40575 | 2 | 252 | | | | 50210 | 9 | 309 | 60310 | 3 | 102 | 71006 | 1 | 451,474 | 75001 | 2 | 271 |
| 40576 | 9 | 252 | 40676 | 6 | 138,230,367 | 50305 | 2 | 309 | 60502 | 2 | 277 | 71400 | 7 | 426 | 75002 | 9 | 271 |
| 40577 | 6 | 252 | 40680 | 3 | 230 | 50400 | 4 | 309 | 60503 | 9 | 277 | 71421 | 2 | 477,496 | 75600 | 7 | 451 |
| 40600 | 1 | 234 | 40681 | 0 | 230 | 50600 | 8 | 310 | 60505 | 3 | 277 | 71430 | 4 | 418 | 75800 | 1 | 450 |
| 40601 | 8 | 114,234 | 40685 | 8 | 128,236,245 | 50601 | 5 | 310 | 60508 | 4 | 277 | 71431 | 1 | 403,472 | 75801 | 8 | 449 |
| 40602 | 5 | 234 | 40686 | 5 | 128,236,246 | 50602 | 2 | 310 | 60509 | 1 | 276 | 71433 | 5 | 426 | 75803 | 2 | 451 |
| 40603 | 2 | 234 | 40690 | 2 | 237,323 | 50603 | 9 | 310 | 60510 | 7 | 276 | 71440 | 3 | 364 | 75804 | 9 | 451 |
| 40604 | 9 | 237,323 | 40691 | 9 | 237,323 | 50605 | 3 | 310 | 60511 | 4 | 276 | 71441 | 0 | 365 | 75805 | 6 | 407 |
| 40605 | 6 | 235 | 40692 | 6 | 237,323 | 50606 | 0 | 310 | 60512 | 1 | 276 | 71460 | 1 | 299 | 75806 | 3 | 450 |
| 40606 | 3 | 235 | 40693 | 3 | 237,323 | 50607 | 7 | 310 | 60520 | 6 | 277 | 71461 | 8 | 299 | 75807 | 0 | 450 |
| 40607 | 0 | 235 | 40694 | 0 | 237,323 | 50608 | 4 | 310 | 60521 | 3 | 277 | 71470 | 0 | 304 | 75808 | 7 | 452 |
| 40610 | 0 | 234 | 40695 | 7 | 237,323 | 50612 | 1 | 310 | 60522 | 0 | 277 | 71471 | 7 | 304 | 75809 | 4 | 452 |
| 40611 | 7 | 234 | 40700 | 8 | 229 | 50620 | 6 | 311 | 60523 | 7 | 277 | 71480 | 9 | 304 | 75810 | 0 | 449 |
| 40612 | 4 | 234 | 40701 | 5 | 229 | 50621 | 3 | 311 | 60524 | 4 | 277 | 71487 | 8 | 302 | 75820 | 9 | 407,452 |
| 40613 | 1 | 234 | 40702 | 2 | 229 | 50622 | 0 | 311 | 60525 | 1 | 277 | 71489 | 2 | 302 | 75821 | 6 | 407,452 |
| 40616 | 2 | 235 | 40703 | 9 | 229 | 50623 | 7 | 311 | 60526 | 8 | 277 | 71490 | 8 | 304 | 75822 | 3 | 449 |
| 40617 | 9 | 235 | 40704 | 6 | 229 | 50624 | 4 | 311 | 60527 | 5 | 277 | 71491 | 5 | 304 | 75823 | 0 | 449 |
| 40618 | 6 | 235 | 40705 | 3 | 229 | 50625 | 1 | 311 | 60528 | 2 | 277 | 71492 | 2 | 301 | 75824 | 7 | 449 |
| 40620 | 9 | 234 | 40706 | 0 | 229 | 50626 | 8 | 311 | 60530 | 5 | 276 | 71493 | 9 | 301 | 75825 | 4 | 448 |
| 40621 | 6 | 234 | 40707 | 7 | 229 | 50627 | 5 | 311 | 60531 | 2 | 276 | 71494 | 6 | 301 | 75830 | 8 | 448 |
| 40622 | 3 | 234 | 40708 | 4 | 229 | 50630 | 5 | 310 | 60534 | 3 | 276 | 71495 | 3 | 303 | 75831 | 5 | 448 |
| 40623 | 0 | 234 | 40709 | 1 | 229 | 50631 | 2 | 310 | 60535 | 0 | 278 | 71496 | 0 | 298 | 75832 | 2 | 448 |
| 40624 | 7 | 234 | 40710 | 7 | 229,235 | 50644 | 2 | 318 | 60536 | 7 | 278 | 71497 | 7 | 298 | 75840 | 7 | 446 |
| 40625 | 4 | 114,234 | 40711 | 4 | 229,235 | 50702 | 9 | 309 | 60537 | 4 | 278 | 71498 | 4 | 302 | 75841 | 4 | 446 |
| 40626 | 1 | 234 | 40712 | 1 | 228 | 50707 | 4 | 309 | 60540 | 4 | 276 | 71499 | 1 | 302 | 75842 | 1 | 446 |
| 40627 | 8 | 234 | 40713 | 8 | 228 | 50710 | 4 | 308 | 60541 | 1 | 276 | 71510 | 3 | 299 | 75843 | 8 | 446 |
| 40628 | 5 | 234 | 40720 | 6 | 238 | 50712 | 8 | 308 | 60542 | 8 | 276 | 71512 | 7 | 299 | 75844 | 5 | 446 |
| 40629 | 2 | 234 | 40721 | 3 | 238 | 50722 | 7 | 309 | 60543 | 5 | 278 | 71513 | 4 | 299 | 75850 | 6 | 448 |
| 40630 | 8 | 235 | 40722 | 0 | 229,238 | 50800 | 2 | 310 | 60544 | 2 | 278 | 71516 | 5 | 299 | 75851 | 3 | 448 |
| 40631 | 5 | 235 | 40723 | 7 | 229,238 | 50801 | 9 | 310 | 60545 | 9 | 278 | 71520 | 2 | 298 | 75852 | 0 | 448 |
| 40632 | 2 | 280 | 40724 | 4 | 238 | 50802 | 6 | 310 | 60546 | 6 | 278 | 71521 | 9 | 297 | 75853 | 7 | 407,448 |
| 40633 | 9 | 280 | 40725 | 1 | 238 | 50803 | 3 | 310 | 60551 | 0 | 277 | 71522 | 6 | 297 | 75854 | 4 | 407,448 |
| 40634 | 6 | 280 | 40726 | 8 | 229,238 | 50805 | 7 | 310 | 60552 | 7 | 277 | 71523 | 3 | 297 | 75855 | 1 | 407,448 |
| 40635 | 3 | 280 | 40727 | 5 | 229,238 | 50806 | 4 | 310 | 60554 | 1 | 277 | 71527 | 1 | 297 | 75900 | 8 | 441 |
| 40636 | 0 | 280 | 40728 | 2 | 238 | 50807 | 1 | 310 | 61190 | 0 | 102 | 71528 | 8 | 297 | 75902 | 2 | 441 |
| 40637 | 7 | 280 | 40729 | 9 | 238 | 50808 | 8 | 310 | 61280 | 8 | 102 | 71529 | 5 | 297 | 75903 | 9 | 441 |
| 40638 | 4 | 280 | 40730 | 5 | 232 | 50815 | 6 | 310 | 61400 | 0 | 102 | 71531 | 8 | 298 | 75904 | 6 | 441 |
| 40640 | 7 | 235,269,415 | 40731 | 2 | 232 | 50817 | 0 | 310 | 65060 | 2 | 271,347 | 73502 | 6 | 478 | 75906 | 0 | 441,481 |
| 40642 | 1 | 233 | 40732 | 9 | 232 | 50823 | 1 | 310 | 65061 | 9 | 347 | 73505 | 7 | 478 | 75907 | 7 | 441 |
| 40643 | 8 | 233 | 40733 | 6 | 232 | 50905 | 4 | 308 | 65062 | 6 | 347 | 73506 | 4 | 478 | 75908 | 4 | 441 |
| 40644 | 5 | 233 | 40734 | 3 | 232 | 50908 | 5 | 308 | 65070 | 1 | 394 | 73507 | 1 | 478,479 | 75912 | 1 | 441 |
| 40645 | 2 | 280 | 40735 | 0 | 232 | 50910 | 8 | 308 | 65071 | 8 | 394 | 73508 | 8 | 478 | 77315 | 8 | 474 |
| 40646 | 9 | 280 | 40736 | 7 | 232 | 50913 | 9 | 308 | 65072 | 5 | 394 | 73509 | 5 | 478 | 77338 | 7 | 466 |
| 40647 | 6 | 280 | 40737 | 4 | 232 | 50915 | 3 | 308 | 66900 | 0 | 329,435 | 73510 | 1 | 478 | 77350 | 9 | 472,481 |
| 40654 | 4 | 236 | 40738 | 1 | 232 | 50918 | 4 | 308 | 66901 | 7 | 329,435 | 73511 | 8 | 478 | 79000 | 1 | 72 |
| 40655 | 1 | 111,236, 251,420 | 40740 | 4 | 233 | 6 | | | 66902 | 4 | 329,435 | 73513 | 2 | 478 | 79001 | 8 | 72 |
| 40656 | 8 | 111,236, 251,420 | 40741 | 1 | 233 | 60002 | 7 | 277 | 66904 | 8 | 472 | 73515 | 6 | 479 | 79002 | 5 | 72 |
| 40657 | 5 | 236 | 40742 | 8 | 233 | 60012 | 6 | 277 | 66905 | 5 | 433 | 73750 | 1 | 481 | 79003 | 2 | 72 |
| 40658 | 2 | 236 | 40752 | 7 | 491 | 60014 | 0 | 277 | 66906 | 2 | 433 | 74201 | 7 | 462 | 79004 | 9 | 72 |
| 40659 | 9 | 236 | 40760 | 2 | 239 | 60015 | 7 | 277 | 66910 | 9 | 305,432,497 | 74402 | 8 | 465 | 79005 | 6 | 72 |
| 40660 | 5 | 233 | 40761 | 9 | 239 | 60016 | 4 | 277 | 66911 | 6 | 305,432,497 | 74404 | 2 | 465 | 79006 | 3 | 72 |
| 40661 | 2 | 279 | 40762 | 6 | 239 | 60018 | 8 | 277 | 66912 | 3 | 305,432,497 | 74700 | 5 | 463 | 79007 | 0 | 72 |
| 40662 | 9 | 279 | 40763 | 3 | 239 | 60019 | 5 | 277 | 66913 | 0 | 305,432,497 | 74701 | 2 | 463 | 79553 | 2 | 84 |
| 40663 | 6 | 279 | 40764 | 0 | 239 | 60037 | 9 | 276 | 66914 | 7 | 305,432,497 | 74702 | 9 | 463 | | | |
| 40664 | 3 | 279 | 40765 | 7 | 239 | 60038 | 6 | 276 | 66915 | 4 | 305,432,497 | 74703 | 6 | 463 | | | |
| 40665 | 0 | 279 | 40766 | 4 | 239 | 60040 | 9 | 276 | 66916 | 1 | 305,432,497 | 74705 | 0 | 463 | 8 | | |
| | | | 40767 | 1 | 239 | 60041 | 6 | 277 | 66917 | 8 | 305,432,497 | 74706 | 7 | 463 | 80023 | 6 | 356 |
| | | | | | | | | | 7 | | | 74707 | 4 | 464 | 80024 | 3 | 356 |

| | | | | | | | | | | | | | | | | | |
|-------|---|-----|-------|---|---------------|-------|---|--------------|-------|---|------------------------|-------|---|--------------------|-------|---|--------------------|
| 80025 | 0 | 356 | 81791 | 3 | 355 | 82072 | 2 | 359 | 82276 | 4 | 361 | 83433 | 0 | 207, 363 | 83718 | 8 | 197 |
| 80026 | 7 | 356 | 81795 | 1 | 355 | 82073 | 9 | 359 | 82277 | 1 | 361 | 83434 | 7 | 207, 363 | 83720 | 1 | 197 |
| 80027 | 4 | 356 | 81796 | 8 | 360 | 82074 | 6 | 359 | 82278 | 8 | 361 | 83437 | 8 | 214 | 83721 | 8 | 196 |
| 80028 | 1 | 356 | 81800 | 2 | 353 | 82076 | 0 | 359 | 82279 | 5 | 361 | 83438 | 5 | 214 | 83722 | 5 | 197 |
| 80029 | 8 | 356 | 81801 | 9 | 353 | 82077 | 7 | 359 | 82280 | 1 | 361 | 83440 | 8 | 214 | 83723 | 2 | 196 |
| 81000 | 6 | 353 | 81802 | 6 | 353 | 82078 | 4 | 359 | 82281 | 8 | 361 | 83441 | 5 | 214 | 83724 | 9 | 197 |
| 81095 | 2 | 353 | 81804 | 0 | 353 | 82081 | 4 | 359 | 82300 | 6 | 361 | 83443 | 9 | 214 | 83725 | 6 | 196 |
| 81100 | 3 | 353 | 81806 | 4 | 353 | 82100 | 2 | 361 | 82301 | 3 | 361 | 83450 | 7 | 208 | 83726 | 3 | 197 |
| 81101 | 0 | 353 | 81850 | 7 | 354 | 82101 | 9 | 357 | 82306 | 8 | 361 | 83451 | 4 | 208, 225 | 83727 | 0 | 196 |
| 81102 | 7 | 353 | 81891 | 0 | 355 | 82104 | 0 | 357 | 82307 | 5 | 281 | 83452 | 1 | 208 | 83728 | 7 | 197 |
| 81104 | 1 | 353 | 81895 | 8 | 355 | 82106 | 4 | 357 | 82308 | 2 | 281 | 83453 | 8 | 208 | 83730 | 0 | 197 |
| 81106 | 5 | 353 | 81901 | 6 | 354 | 82108 | 8 | 357 | 82309 | 9 | 281 | 83454 | 5 | 208 | 83732 | 4 | 197 |
| 81108 | 9 | 353 | 81902 | 3 | 354 | 82110 | 1 | 357 | 82310 | 5 | 79, 284, 286 | 83455 | 2 | 208 | 83735 | 5 | 196 |
| 81109 | 6 | 353 | 81903 | 0 | 354 | 82112 | 5 | 357 | 82312 | 9 | 79, 128, 245, 284, 286 | 83466 | 8 | 208, 210 | 83739 | 3 | 196 |
| 81116 | 4 | 351 | 81904 | 7 | 354 | 82113 | 2 | 357 | 82314 | 3 | 79, 284, 286 | 83467 | 5 | 208 | 83740 | 9 | 198 |
| 81117 | 1 | 356 | 81905 | 4 | 354 | 82114 | 9 | 357 | 82316 | 7 | 246, 285 | 83468 | 2 | 208 | 83742 | 3 | 198 |
| 81118 | 8 | 356 | 81906 | 1 | 354 | 82116 | 3 | 357 | 82318 | 1 | 286 | 83469 | 9 | 208 | 83744 | 7 | 198 |
| 81191 | 1 | 355 | 81907 | 8 | 354 | 82117 | 0 | 357 | 82319 | 8 | 286 | 83479 | 8 | 207, 363 | 83748 | 5 | 225, 362 |
| 81195 | 9 | 355 | 81908 | 5 | 354 | 82118 | 7 | 357 | 82328 | 0 | 61, 64 | 83480 | 4 | 207, 363 | 83749 | 2 | 225, 362 |
| 81198 | 0 | 360 | 81909 | 2 | 354 | 82119 | 4 | 357 | 82328 | 0 | 61, 64 | 83481 | 1 | 68, 207, 363 | 83750 | 8 | 225, 362 |
| 81199 | 7 | 360 | 81910 | 8 | 354 | 82120 | 0 | 357 | 82338 | 9 | 286 | 83482 | 8 | 207, 363 | 83751 | 5 | 362 |
| 81200 | 0 | 353 | 81911 | 5 | 354 | 82122 | 4 | 357 | 82345 | 7 | 284 | 83484 | 2 | 208 | 83752 | 2 | 225, 362 |
| 81201 | 7 | 353 | 81996 | 2 | 356 | 82123 | 1 | 357 | 82346 | 4 | 284 | 83486 | 6 | 220 | 83753 | 9 | 225, 362 |
| 81202 | 4 | 353 | 81997 | 9 | 356 | 82128 | 6 | 357 | 82347 | 1 | 284 | 83487 | 3 | 220 | 83754 | 6 | 225, 362 |
| 81204 | 8 | 353 | 81998 | 6 | 356 | 82129 | 3 | 357 | 82350 | 1 | 125, 248, 285 | 83488 | 0 | 429 | 83755 | 3 | 225, 362 |
| 81206 | 2 | 353 | 81999 | 3 | 356 | 82130 | 9 | 357 | 82351 | 8 | 125, 248, 285 | 83489 | 7 | 429 | 83756 | 0 | 225, 362 |
| 81208 | 6 | 353 | 82001 | 2 | 225, 358, 362 | 82132 | 3 | 357 | 82352 | 5 | 284 | 83490 | 3 | 207, 363 | 83757 | 7 | 225, 362 |
| 81209 | 3 | 353 | 82003 | 6 | 358 | 82134 | 7 | 357 | 82354 | 9 | 285 | 83491 | 0 | 68, 207, 363 | 83758 | 4 | 225, 362 |
| 81292 | 5 | 355 | 82004 | 3 | 358 | 82136 | 1 | 357 | 82355 | 6 | 15, 360 | 83492 | 7 | 207, 363 | 83759 | 1 | 225, 362 |
| 81295 | 6 | 355 | 82005 | 0 | 358 | 82137 | 8 | 357 | 82356 | 3 | 15, 360 | 83498 | 9 | 210 | 83760 | 7 | 224, 363 |
| 81296 | 3 | 360 | 82006 | 7 | 358 | 82138 | 5 | 357 | 82357 | 0 | 15, 360 | 83499 | 6 | 210 | 83761 | 4 | 224, 363 |
| 81300 | 7 | 353 | 82007 | 4 | 358 | 82140 | 8 | 357 | 82359 | 4 | 285 | 83500 | 9 | 208 | 83762 | 1 | 224, 363 |
| 81302 | 1 | 353 | 82008 | 1 | 358 | 82142 | 2 | 357 | 82360 | 0 | 282 | 83514 | 6 | 208 | 83763 | 8 | 224, 363 |
| 81304 | 5 | 353 | 82010 | 4 | 358 | 82150 | 7 | 357 | 82361 | 7 | 282 | 83592 | 4 | 207, 363 | 83764 | 5 | 224, 363 |
| 81306 | 9 | 353 | 82012 | 8 | 358 | 82151 | 4 | 357 | 82362 | 4 | 283 | 83597 | 9 | 207, 363 | 83765 | 2 | 224, 363 |
| 81308 | 3 | 353 | 82013 | 5 | 225, 358, 362 | 82159 | 0 | 357 | 82363 | 1 | 283 | 83600 | 6 | 186, 210, 494 | 83766 | 9 | 224, 363 |
| 81391 | 5 | 355 | 82014 | 2 | 358 | 82200 | 9 | 361 | 82370 | 9 | 285 | 83601 | 3 | 183, 186, 210, 494 | 83768 | 3 | 224, 363 |
| 81395 | 3 | 355 | 82016 | 6 | 358 | 82210 | 8 | 338, 340 | 82371 | 6 | 285 | 83603 | 7 | 209, 494 | 83769 | 0 | 224, 363 |
| 81400 | 4 | 353 | 82017 | 3 | 358 | 82215 | 3 | 338, 340 | 82394 | 5 | 286 | 83604 | 4 | 209, 494 | 83772 | 0 | 224, 363 |
| 81401 | 1 | 353 | 82018 | 0 | 358 | 82239 | 9 | 65, 282, 283 | 82395 | 2 | 286 | 83605 | 1 | 213, 494 | 83773 | 7 | 224, 363 |
| 81402 | 8 | 353 | 82019 | 7 | 225, 358, 362 | 82240 | 5 | 65, 282, 283 | 82419 | 5 | 368, 477 | 83606 | 8 | 213, 494 | 83777 | 5 | 213, 239 |
| 81404 | 2 | 353 | 82020 | 3 | 358 | 82241 | 2 | 282 | 82420 | 1 | 368 | 83606 | 8 | 213, 494 | 83780 | 5 | 213, 239 |
| 81406 | 6 | 353 | 82022 | 7 | 358 | 82242 | 9 | 282 | 82440 | 9 | 368, 480 | 83607 | 5 | 213, 494 | 83781 | 2 | 213, 237, 239, 323 |
| 81408 | 0 | 353 | 82023 | 4 | 358 | 82243 | 6 | 65 | 82441 | 6 | 368, 480 | 83610 | 5 | 429 | 83782 | 9 | 213, 239 |
| 81492 | 9 | 355 | 82028 | 9 | 358 | 82244 | 3 | 65 | 83310 | 4 | 73 | 83611 | 2 | 429 | 83783 | 6 | 213, 239 |
| 81495 | 0 | 355 | 82029 | 6 | 225, 358, 362 | 82245 | 0 | 283 | 83311 | 1 | 73 | 83612 | 9 | 429 | 83785 | 0 | 203 |
| 81502 | 5 | 353 | 82030 | 2 | 358 | 82246 | 7 | 283 | 83401 | 9 | 207, 363 | 83613 | 6 | 429 | 83787 | 4 | 203 |
| 81504 | 9 | 353 | 82032 | 6 | 358 | 82250 | 4 | 64 | 83402 | 6 | 207 | 83615 | 0 | 88 | 83788 | 1 | 203 |
| 81506 | 3 | 353 | 82034 | 0 | 358 | 82251 | 1 | 64 | 83403 | 3 | 207 | 83616 | 7 | 430 | 83789 | 8 | 203 |
| 81591 | 9 | 355 | 82036 | 4 | 358 | 82252 | 8 | 64 | 83404 | 0 | 207 | 83648 | 8 | 220 | 83790 | 4 | 203 |
| 81595 | 7 | 355 | 82037 | 1 | 225, 358, 362 | 82253 | 5 | 64 | 83405 | 7 | 207 | 83649 | 5 | 220 | 83790 | 4 | 203 |
| 81602 | 2 | 353 | 82038 | 8 | 358 | 82255 | 9 | 63 | 83406 | 4 | 207 | 83696 | 9 | 33, 212 | 83798 | 0 | 213, 239 |
| 81604 | 6 | 353 | 82040 | 1 | 358 | 82256 | 6 | 63 | 83407 | 1 | 207 | 83697 | 6 | 33, 212 | 83799 | 7 | 203 |
| 81606 | 0 | 353 | 82042 | 5 | 358 | 82257 | 3 | 63 | 83408 | 8 | 208 | 83698 | 3 | 33, 212 | 83800 | 0 | 202, 221 |
| 81608 | 4 | 353 | 82050 | 0 | 358 | 82265 | 8 | 63 | 83409 | 5 | 208 | 83699 | 0 | 33, 212 | 83801 | 7 | 218, 351 |
| 81692 | 3 | 355 | 82051 | 7 | 358 | 82266 | 5 | 63 | 83410 | 1 | 208 | 83700 | 3 | 19, 33, 212 | 83803 | 1 | 218, 351 |
| 81695 | 4 | 355 | 82059 | 3 | 358 | 82267 | 2 | 63 | 83414 | 9 | 208, 210 | 83701 | 0 | 19, 33, 212 | 83808 | 6 | 202, 221 |
| 81700 | 5 | 353 | 82064 | 7 | 359 | 82270 | 2 | 361 | 83415 | 6 | 208 | 83702 | 7 | 19, 33, 212 | 83828 | 4 | 202, 204 |
| 81701 | 2 | 353 | 82065 | 4 | 359 | 82271 | 9 | 361 | 83417 | 0 | 207 | 83703 | 4 | 19, 33, 212 | 83830 | 7 | 202, 204 |
| 81702 | 9 | 353 | 82066 | 1 | 359 | 82272 | 6 | 361 | 83418 | 7 | 207 | 83704 | 1 | 33, 212 | 83842 | 0 | 220 |
| 81704 | 3 | 353 | 82068 | 5 | 359 | 82273 | 3 | 361 | 83419 | 4 | 208 | 83705 | 8 | 33, 212 | 83843 | 7 | 220 |
| 81706 | 7 | 353 | 82069 | 2 | 359 | 82274 | 0 | 361 | 83424 | 8 | 220 | 83712 | 6 | 195 | 83848 | 2 | 218 |
| 81707 | 4 | 353 | 82070 | 8 | 359 | 82275 | 7 | 361 | 83426 | 2 | 220 | 83716 | 4 | 196 | 83851 | 2 | 218 |

| | | | | | | | | | | | | | | | | | |
|-------|---|----------------------------|-------|---|----------|-------|---|----------|-------|---|----------|-------|---|-----|-------|---|----------|
| 83867 | 3 | 73 | 83992 | 2 | 186 | 84208 | 3 | 173 | 84445 | 2 | 222 | 84586 | 2 | 182 | 84824 | 5 | 169 |
| 83868 | 0 | 73 | 83994 | 6 | 186 | 84209 | 0 | 173 | 84446 | 9 | 222 | 84587 | 9 | 182 | 84825 | 2 | 168 |
| 83869 | 7 | 208, 217 | 84018 | 8 | 223, 239 | 84215 | 1 | 213 | 84448 | 3 | 222 | 84589 | 3 | 182 | 84826 | 9 | 168 |
| 83878 | 9 | 204 | 84020 | 1 | 218 | 84216 | 8 | 213 | 84449 | 0 | 222 | 84590 | 9 | 182 | 84827 | 6 | 168 |
| 83879 | 6 | 204 | 84021 | 8 | 218 | 84217 | 5 | 201, 223 | 84450 | 6 | 222 | 84592 | 3 | 183 | 84828 | 3 | 168 |
| 83880 | 2 | 212 | 84035 | 5 | 218 | 84220 | 5 | 213 | 84452 | 0 | 222 | 84593 | 0 | 183 | 84829 | 0 | 168 |
| 83881 | 9 | 212 | 84040 | 9 | 217 | 84221 | 2 | 212 | 84454 | 4 | 222 | 84605 | 0 | 181 | 84830 | 6 | 169 |
| 83884 | 0 | 208 | 84041 | 6 | 217 | 84230 | 4 | 199 | 84456 | 8 | 222 | 84606 | 7 | 181 | 84831 | 3 | 169 |
| 83887 | 1 | 219 | 84042 | 3 | 217 | 84231 | 1 | 199 | 84458 | 2 | 222 | 84607 | 4 | 181 | 84835 | 1 | 169 |
| 83888 | 8 | 219 | 84043 | 0 | 217 | 84232 | 8 | 199 | 84460 | 5 | 220 | 84608 | 1 | 181 | 84836 | 8 | 169 |
| 83889 | 5 | 219 | 84045 | 4 | 131, 423 | 84233 | 5 | 199 | 84462 | 9 | 203 | 84609 | 8 | 181 | 84837 | 5 | 169 |
| 83890 | 1 | 135, 216, 288 | 84046 | 1 | 15, 210 | 84244 | 1 | 186, 209 | 84464 | 3 | 203 | 84610 | 4 | 181 | 84860 | 3 | 73 |
| 83891 | 8 | 135, 216, 288 | 84047 | 8 | 15, 210 | 84245 | 8 | 186, 209 | 84466 | 7 | 203 | 84611 | 1 | 181 | 84861 | 0 | 73 |
| 83892 | 5 | 135, 216, 288 | 84048 | 5 | 15, 210 | 84251 | 9 | 110, 422 | 84470 | 4 | 221, 239 | 84612 | 8 | 181 | 84862 | 7 | 73 |
| 83893 | 2 | 216, 288 | 84100 | 0 | 190 | 84253 | 3 | 110, 422 | 84471 | 1 | 221, 239 | 84613 | 5 | 181 | 84863 | 4 | 73 |
| 83897 | 0 | 218, 351 | 84101 | 7 | 190 | 84256 | 4 | 171 | 84472 | 8 | 221, 239 | 84614 | 2 | 181 | 84875 | 7 | 189 |
| 83900 | 7 | 205 | 84103 | 1 | 192 | 84257 | 1 | 187 | 84490 | 2 | 211 | 84671 | 5 | 159 | 84876 | 4 | 189 |
| 83901 | 4 | 205 | 84104 | 8 | 192 | 84258 | 8 | 187 | 84491 | 9 | 211 | 84672 | 2 | 159 | 84900 | 6 | 193 |
| 83902 | 1 | 205 | 84105 | 5 | 192 | 84259 | 5 | 187 | 84492 | 6 | 211 | 84673 | 9 | 159 | 84901 | 3 | 193 |
| 83903 | 8 | 205 | 84106 | 2 | 192 | 84265 | 6 | 173 | 84509 | 1 | 164 | 84674 | 6 | 160 | 84902 | 0 | 193 |
| 83904 | 5 | 205 | 84107 | 9 | 191 | 84266 | 3 | 171 | 84510 | 7 | 164 | 84675 | 3 | 160 | 84903 | 7 | 193 |
| 83905 | 2 | 205 | 84108 | 6 | 191 | 84268 | 7 | 171 | 84511 | 4 | 164 | 84676 | 0 | 160 | 84904 | 4 | 194 |
| 83906 | 9 | 205 | 84109 | 3 | 191 | 84269 | 4 | 171 | 84512 | 1 | 164 | 84677 | 7 | 160 | 84905 | 1 | 194 |
| 83907 | 6 | 205 | 84110 | 9 | 191 | 84295 | 3 | 213 | 84514 | 5 | 164 | 84678 | 4 | 160 | 84906 | 8 | 194 |
| 83908 | 3 | 205 | 84111 | 6 | 191 | 84300 | 4 | 225, 362 | 84515 | 2 | 164 | 84680 | 7 | 161 | 84907 | 5 | 194 |
| 83909 | 0 | 205 | 84112 | 3 | 191 | 84301 | 1 | 225, 362 | 84517 | 6 | 164 | 84681 | 4 | 161 | 84908 | 2 | 194 |
| 83910 | 6 | 206 | 84113 | 0 | 191 | 84302 | 8 | 225, 362 | 84519 | 0 | 166 | 84682 | 1 | 161 | 84909 | 9 | 194 |
| 83911 | 3 | 206 | 84115 | 4 | 191 | 84303 | 5 | 225, 362 | 84520 | 6 | 166 | 84683 | 8 | 161 | 84910 | 5 | 194 |
| 83912 | 0 | 204, 206 | 84116 | 1 | 191 | 84304 | 2 | 225, 362 | 84521 | 3 | 166 | 84684 | 5 | 162 | 84911 | 2 | 194 |
| 83913 | 7 | 204, 206 | 84117 | 8 | 192 | 84305 | 9 | 225, 362 | 84522 | 0 | 166 | 84685 | 2 | 162 | 84912 | 9 | 194 |
| 83914 | 4 | 206 | 84118 | 5 | 192 | 84306 | 6 | 225, 362 | 84523 | 7 | 165 | 84686 | 9 | 162 | 84920 | 4 | 179 |
| 83915 | 1 | 206 | 84119 | 2 | 192 | 84307 | 3 | 225, 362 | 84524 | 4 | 165 | 84687 | 6 | 162 | 84921 | 1 | 179 |
| 83916 | 8 | 206 | 84125 | 3 | 200 | 84308 | 0 | 225, 362 | 84525 | 1 | 165 | 84688 | 3 | 162 | 84922 | 8 | 179 |
| 83917 | 5 | 206 | 84126 | 0 | 200 | 84309 | 7 | 225, 362 | 84526 | 8 | 165 | 84689 | 0 | 162 | 84923 | 5 | 179 |
| 83918 | 2 | 206 | 84128 | 4 | 200, 219 | 84310 | 3 | 225, 362 | 84528 | 2 | 165 | 84690 | 6 | 162 | 84924 | 2 | 179 |
| 83919 | 9 | 206 | 84130 | 7 | 201 | 84311 | 0 | 225, 362 | 84529 | 9 | 165 | 84728 | 6 | 192 | 84925 | 9 | 179 |
| 83920 | 5 | 33, 69, 206, 212, 214, 494 | 84131 | 4 | 201 | 84329 | 5 | 167 | 84530 | 5 | 165 | 84729 | 3 | 192 | 84926 | 6 | 180 |
| 83921 | 2 | 206, 494 | 84132 | 1 | 201 | 84331 | 8 | 167 | 84555 | 8 | 182 | 84730 | 9 | 192 | 84927 | 3 | 180 |
| 83922 | 9 | 206, 494 | 84133 | 8 | 201 | 84335 | 6 | 167 | 84556 | 5 | 182 | 84731 | 6 | 190 | 84928 | 0 | 180 |
| 83923 | 6 | 206 | 84134 | 5 | 201 | 84337 | 0 | 167 | 84558 | 9 | 182 | 84732 | 3 | 190 | 84929 | 7 | 180 |
| 83924 | 3 | 206 | 84135 | 2 | 201 | 84348 | 6 | 196 | 84559 | 6 | 182 | 84733 | 0 | 190 | 84930 | 3 | 181 |
| 83925 | 0 | 206 | 84158 | 1 | 200, 219 | 84349 | 3 | 196 | 84561 | 9 | 182 | 84750 | 7 | 221 | 84931 | 0 | 181 |
| 83926 | 7 | 206 | 84161 | 1 | 189 | 84351 | 6 | 196 | 84562 | 6 | 182 | 84775 | 0 | 223 | 84932 | 7 | 181 |
| 83929 | 8 | 195 | 84170 | 3 | 189 | 84353 | 0 | 196 | 84564 | 0 | 182 | 84776 | 7 | 223 | 84933 | 4 | 181 |
| 83932 | 8 | 197 | 84171 | 0 | 189 | 84355 | 4 | 195 | 84565 | 7 | 182 | 84777 | 4 | 223 | 84934 | 1 | 181 |
| 83933 | 5 | 197 | 84172 | 7 | 189 | 84365 | 3 | 174 | 84567 | 1 | 175 | 84778 | 1 | 223 | 84935 | 8 | 181 |
| 83935 | 9 | 197 | 84174 | 1 | 191 | 84366 | 0 | 174 | 84568 | 8 | 175 | 84779 | 8 | 223 | 84936 | 5 | 182 |
| 83941 | 0 | 198 | 84177 | 2 | 172 | 84377 | 6 | 174 | 84569 | 5 | 176 | 84780 | 4 | 223 | 84937 | 2 | 182 |
| 83946 | 5 | 198 | 84178 | 9 | 172 | 84378 | 3 | 174 | 84570 | 1 | 176 | 84781 | 1 | 223 | 84943 | 3 | 179 |
| 83947 | 2 | 198 | 84179 | 6 | 172 | 84379 | 0 | 174 | 84571 | 8 | 176 | 84782 | 8 | 223 | 84944 | 0 | 179 |
| 83949 | 6 | 198 | 84180 | 2 | 188 | 84380 | 6 | 174 | 84572 | 5 | 176 | 84783 | 5 | 223 | 84948 | 8 | 183 |
| 83955 | 7 | 185 | 84181 | 9 | 188 | 84381 | 3 | 174 | 84573 | 2 | 176 | 84785 | 9 | 203 | 84950 | 1 | 211 |
| 83956 | 4 | 185 | 84182 | 6 | 188 | 84400 | 1 | 169 | 84574 | 9 | 176 | 84803 | 0 | 163 | 84951 | 8 | 211 |
| 83957 | 1 | 185 | 84185 | 7 | 24, 188 | 84401 | 8 | 169 | 84575 | 6 | 175 | 84804 | 7 | 163 | 84958 | 7 | 211 |
| 83958 | 8 | 185 | 84186 | 4 | 24, 188 | 84402 | 5 | 169 | 84576 | 3 | 175 | 84805 | 4 | 163 | 84959 | 4 | 211 |
| 83960 | 1 | 202 | 84187 | 1 | 68, 188 | 84403 | 2 | 169 | 84577 | 0 | 176 | 84806 | 1 | 163 | 84962 | 4 | 181, 493 |
| 83961 | 8 | 202 | 84188 | 8 | 24, 188 | 84404 | 9 | 169 | 84578 | 7 | 176 | 84807 | 8 | 163 | 84963 | 1 | 181, 493 |
| 83962 | 5 | 202 | 84189 | 5 | 24, 188 | 84424 | 7 | 208 | 84579 | 4 | 176 | 84808 | 5 | 163 | 84964 | 8 | 181, 493 |
| 83971 | 7 | 185 | 84200 | 7 | 203 | 84425 | 4 | 208 | 84580 | 0 | 176 | 84815 | 3 | 163 | 84965 | 5 | 182, 493 |
| 83980 | 9 | 185 | 84202 | 1 | 203 | 84426 | 1 | 208 | 84581 | 7 | 176 | 84816 | 0 | 163 | 84966 | 2 | 182, 493 |
| 83981 | 6 | 186 | 84205 | 2 | 173 | 84427 | 8 | 208 | 84582 | 4 | 176 | 84819 | 1 | 163 | 84967 | 9 | 182, 493 |
| | | | 84206 | 9 | 173 | 84434 | 6 | 172 | 84583 | 1 | 182 | 84820 | 7 | 168 | 84968 | 6 | 182, 493 |
| | | | 84207 | 6 | 173 | 84444 | 5 | 222 | 84584 | 8 | 182 | 84821 | 4 | 168 | 84985 | 3 | 183 |

| | | | | | | | | | | | | | | | | | |
|-------|---|----------|-------|---|---------------|----------|---|----------|-------|---|----------|-------|---|----------|-------|---|-----|
| 84986 | 0 | 170 | 85125 | 2 | 153 | 88636 | 0 | 453 | 93111 | 4 | 412 | 93255 | 5 | 476 | 93358 | 3 | 402 |
| 84987 | 7 | 183 | 85127 | 6 | 153 | 88637 | 7 | 445 | 93112 | 1 | 398 | 93256 | 2 | 476 | 93360 | 6 | 402 |
| 84988 | 4 | 170 | 85128 | 3 | 153 | 88639 | 1 | 463 | 93114 | 5 | 412 | 93257 | 9 | 476 | 93361 | 3 | 402 |
| 85021 | 7 | 148 | 85129 | 0 | 153 | 88640 | 7 | 444 | 93116 | 9 | 398 | 93258 | 6 | 476 | 93362 | 0 | 402 |
| 85024 | 8 | 148 | 85131 | 3 | 153 | 88642 | 1 | 444 | 93120 | 6 | 398 | 93259 | 3 | 475 | 93364 | 4 | 391 |
| 85025 | 5 | 148 | 85132 | 0 | 153 | 88643 | 8 | 450 | 93121 | 3 | 398 | 93260 | 9 | 475 | 93365 | 1 | 391 |
| 85026 | 2 | 148 | 85133 | 7 | 153 | 88644 | 5 | 450 | 93122 | 0 | 413 | 93261 | 6 | 475 | 93366 | 8 | 395 |
| 85027 | 9 | 148 | 85135 | 1 | 153 | 88645 | 2 | 450 | 93124 | 4 | 413 | 93270 | 8 | 476 | 93367 | 5 | 388 |
| 85028 | 6 | 148 | 85140 | 5 | 215 | 88688 | 9 | 466 | 93125 | 1 | 413 | 93271 | 5 | 476 | 93368 | 2 | 399 |
| 85029 | 3 | 149 | 85141 | 2 | 215 | 88717 | 6 | 464 | 93129 | 9 | 399 | 93272 | 2 | 476 | 93369 | 9 | 399 |
| 85030 | 9 | 149 | 85145 | 0 | 170 | 88810 | 4 | 456 | 93134 | 3 | 399 | 93273 | 9 | 476 | 93371 | 2 | 391 |
| 85036 | 1 | 149 | 85146 | 7 | 170 | 88811 | 1 | 456 | 93138 | 1 | 396 | 93274 | 6 | 476 | 93372 | 9 | 391 |
| 85037 | 8 | 149 | 85150 | 4 | 201 | 88823 | 4 | 456 | 93139 | 8 | 396 | 93275 | 3 | 476 | 93373 | 6 | 391 |
| 85038 | 5 | 149 | 85151 | 1 | 201 | 88826 | 5 | 456 | 93140 | 4 | 396 | 93280 | 7 | 477 | 93374 | 3 | 391 |
| 85040 | 8 | 217 | 85200 | 6 | 147 | 88827 | 2 | 456 | 93141 | 1 | 411 | 93281 | 4 | 477 | 93375 | 0 | 392 |
| 85041 | 5 | 217 | 85201 | 3 | 147 | 88829 | 6 | 457 | 93144 | 2 | 411 | 93300 | 2 | 400 | 93380 | 4 | 408 |
| 85042 | 2 | 217 | 85202 | 0 | 147 | 88834 | 0 | 457 | 93145 | 9 | 411 | 93301 | 9 | 413 | 93381 | 1 | 408 |
| 85043 | 9 | 217 | 85203 | 7 | 147 | 88836 | 4 | 457 | 93146 | 6 | 411 | 93302 | 6 | 413 | 93382 | 8 | 408 |
| 85055 | 2 | 149 | 85204 | 4 | 147 | 88839 | 5 | 458 | 93147 | 3 | 411 | 93303 | 3 | 409 | 93383 | 5 | 408 |
| 85056 | 9 | 149 | 85205 | 1 | 147 | 88840 | 1 | 458 | 93148 | 0 | 411 | 93304 | 0 | 409 | 93384 | 2 | 408 |
| 85057 | 6 | 149 | 85206 | 8 | 147 | 88843 | 2 | 401, 458 | 93152 | 7 | 399 | 93306 | 4 | 401 | 93385 | 9 | 408 |
| 85060 | 6 | 145 | 85207 | 5 | 147 | 88846 | 3 | 401, 457 | 93153 | 4 | 399 | 93307 | 1 | 401 | 93386 | 6 | 408 |
| 85061 | 3 | 145 | 85208 | 2 | 147 | 88850 | 0 | 457 | 93154 | 1 | 476 | 93308 | 8 | 266, 411 | 93390 | 3 | 408 |
| 85062 | 0 | 145 | 85211 | 2 | 184 | 88853 | 1 | 458 | 93155 | 8 | 475 | 93309 | 5 | 266, 411 | 93391 | 0 | 408 |
| 85063 | 7 | 144 | 85230 | 3 | 184, 216, 287 | 88855 | 5 | 473 | 93156 | 5 | 475 | 93310 | 1 | 389 | 93392 | 7 | 408 |
| 85064 | 4 | 144 | 85231 | 0 | 184, 216, 287 | 88900 | 2 | 473 | 93157 | 2 | 475 | 93311 | 8 | 389 | 93393 | 4 | 408 |
| 85065 | 1 | 144 | 85240 | 2 | 221, 239 | 88901 | 9 | 473 | 93160 | 2 | 412 | 93312 | 5 | 400 | 93394 | 1 | 408 |
| 85066 | 8 | 144 | 85241 | 9 | 221, 239 | 88902 | 6 | 473 | 93161 | 9 | 410 | 93313 | 2 | 400 | 93395 | 8 | 408 |
| 85067 | 5 | 144 | 85242 | 6 | 221, 239 | 88903 | 3 | 474 | 93163 | 3 | 476 | 93318 | 7 | 401, 464 | 93398 | 9 | 392 |
| 85068 | 2 | 144 | 85243 | 3 | 221, 239 | 88911 | 8 | 473 | 93164 | 0 | 397 | 93321 | 7 | 138, 367 | 93399 | 6 | 392 |
| 85069 | 9 | 145 | 85244 | 0 | 221, 239 | 88912 | 5 | 473 | 93165 | 7 | 397 | 93322 | 4 | 389 | 93400 | 9 | 392 |
| 85070 | 5 | 145 | 85250 | 1 | 214 | 88920 | 0 | 459 | 93166 | 4 | 409 | 93323 | 1 | 389 | 98120 | 1 | 90 |
| 85071 | 2 | 145 | 85251 | 8 | 214 | 88921 | 7 | 459 | 93167 | 1 | 409 | 93324 | 8 | 397 | | | |
| 85072 | 9 | 145 | 85252 | 5 | 214 | 88922 | 4 | 459 | 93168 | 8 | 409 | 93325 | 5 | 396 | | | |
| 85073 | 6 | 144 | 85260 | 0 | 209 | 88923 | 1 | 459 | 93169 | 5 | 409 | 93326 | 2 | 395 | | | |
| 85074 | 3 | 146 | 85261 | 7 | 209 | 88928 | 6 | 459 | 93170 | 1 | 410 | 93327 | 9 | 393 | | | |
| 85075 | 0 | 146 | 85266 | 2 | 209 | 88929 | 3 | 461 | 93171 | 8 | 401 | 93328 | 6 | 393 | | | |
| 85076 | 7 | 146 | 85267 | 9 | 209 | 88930 | 9 | 461, 480 | 93173 | 2 | 409 | 93329 | 3 | 393 | | | |
| 85077 | 4 | 146 | 88080 | 1 | 479 | 88932 | 3 | 459 | 93174 | 9 | 409 | 93330 | 9 | 372, 388 | | | |
| 85080 | 4 | 150, 246 | 88081 | 8 | 479 | 88933 | 0 | 459 | 93175 | 6 | 409 | 93331 | 6 | 390 | | | |
| 85081 | 1 | 150, 246 | 88090 | 0 | 478 | 88935 | 4 | 460 | 93176 | 3 | 401 | 93332 | 3 | 390 | | | |
| 85082 | 8 | 151 | 88099 | 3 | 462 | 88937 | 8 | 460 | 93179 | 4 | 396 | 93333 | 0 | 390 | | | |
| 85083 | 5 | 151 | 88220 | 1 | 231 | 88938 | 5 | 460 | 93180 | 0 | 402 | 93334 | 7 | 392 | | | |
| 85084 | 2 | 151 | 88221 | 8 | 231 | 88939 | 2 | 460 | 93181 | 7 | 402 | 93335 | 4 | 392 | | | |
| 85088 | 0 | 187 | 88222 | 5 | 231 | 88940 | 8 | 460 | 93182 | 4 | 402 | 93336 | 1 | 393 | | | |
| 85092 | 7 | 146 | 88223 | 2 | 231 | 88941 | 5 | 460 | 93189 | 3 | 403, 472 | 93337 | 8 | 393 | | | |
| 85093 | 4 | 146 | 88224 | 9 | 231 | 88942 | 2 | 460 | 93190 | 9 | 407 | 93338 | 5 | 393 | | | |
| 85097 | 2 | 146 | 88225 | 6 | 231 | 88946 | 0 | 461 | 93191 | 6 | 406 | 93342 | 2 | 390 | | | |
| 85098 | 9 | 144 | 88226 | 3 | 231 | 88947 | 7 | 461 | 93192 | 3 | 406 | 93343 | 9 | 390 | | | |
| 85099 | 6 | 83, 186 | 88227 | 0 | 231 | 88948 | 4 | 461 | 93200 | 5 | 405 | 93344 | 6 | 390 | | | |
| 85100 | 9 | 152 | 88228 | 7 | 231 | 88949 | 1 | 462, 480 | 93201 | 2 | 396 | 93345 | 3 | 389 | | | |
| 85101 | 6 | 152 | 88229 | 4 | 231 | | | | 93211 | 1 | 395 | 93346 | 0 | 388 | | | |
| 85103 | 0 | 152 | 88256 | 0 | 480 | 9 | | | 93212 | 8 | 395 | 93347 | 7 | 400 | | | |
| 85104 | 7 | 152 | 88271 | 3 | 477 | 90902 | 1 | 34 | 93214 | 2 | 403, 472 | 93348 | 4 | 400 | | | |
| 85105 | 4 | 152 | 88285 | 0 | 360 | 93034 | 6 | 399 | 93220 | 3 | 405 | 93349 | 1 | 400 | | | |
| 85107 | 8 | 152 | 88287 | 4 | 473 | 93090 | 2 | 54, 380 | 93225 | 8 | 475 | 93350 | 7 | 396 | | | |
| 85108 | 5 | 152 | 88288 | 1 | 473 | 93091 | 9 | 54, 380 | 93226 | 5 | 475 | 93351 | 4 | 397 | | | |
| 85109 | 2 | 152 | 88598 | 1 | 453 | 93092 | 6 | 54, 380 | 93230 | 2 | 54 | 93352 | 1 | 397 | | | |
| 85111 | 5 | 152 | 88608 | 7 | 445 | 93093 | 3 | 54, 380 | 93250 | 0 | 476 | 93353 | 8 | 397 | | | |
| 85120 | 7 | 153 | 88609 | 4 | 453 | 93101 | 5 | 411 | 93251 | 7 | 476 | 93354 | 5 | 397 | | | |
| 85121 | 4 | 153 | 88618 | 6 | 463 | 93102 | 2 | 412 | 93252 | 4 | 476 | 93355 | 2 | 397 | | | |
| 85123 | 8 | 153 | 88627 | 8 | 453 | 93105 | 3 | 54, 380 | 93253 | 1 | 476 | 93356 | 9 | 398 | | | |
| 85124 | 5 | 153 | 88628 | 5 | 453 | 93110 | 7 | 412 | 93254 | 8 | 476 | 93357 | 6 | 398 | | | |

DE Impressum

Herausgeber: Assheuer + Pott GmbH & Co. KG, Talweg 11, 59846 Sundern, Tel. +49 2933 97350, info@aps-germany.de, www.aps-germany.de
Gestaltung: Assheuer + Pott GmbH & Co. KG · Druck: Druck- und Verlagshaus Fromm + Rasch GmbH & Co. KG, Breiter Gang 10-16, 49074 Osnabrück
Wir behalten uns das Recht vor, die angegebenen Spezifikationen jederzeit zu ändern. Irrtum, Druckfehler und technische Änderungen vorbehalten. Artikelbeschreibungen sowie Abbildungen und Fotodarstellungen sind ohne Gewähr. Alle Angebote ohne Dekoration. Alle Preise verstehen sich unverbindlich (UVP) in Euro zuzüglich der gesetzlichen Mehrwertsteuer.
© 2023 - Die Vervielfältigung dieses Kataloges - auch wenn partial - muss ausschließlich von der Assheuer + Pott GmbH & Co. KG genehmigt werden.
Bildnachweis: Niklas Thiemann Fotodesign · Stoll GmbH – Studio für Fotografie · track by track GmbH · iStock · Envato Elements Pty Ltd.

GB Imprint

Editor: Assheuer + Pott GmbH & Co. KG, Talweg 11, 59846 Sundern, Germany, Tel. +49 2933 97350, info@aps-germany.de, www.aps-germany.de
Design: Assheuer + Pott GmbH & Co. KG - Print: Druck- und Verlagshaus Fromm + Rasch GmbH & Co. KG, Breiter Gang 10-16, 49074 Osnabrück, Germany
We reserve the right to alter at any time the specifications stated without notice. Errors, printing error and technical changes reserved. Item description as well as images and illustrations are without guaranty. All offers are without decoration. All prices are without commitment (RRP) in Euro and exclude the legal VAT prescribed by law.
© 2023 - This catalogue may not be reproduced in whole or in part unless specific prior written authorization of Assheuer + Pott GmbH & Co. KG.
Picture credits: Niklas Thiemann Fotodesign · Stoll GmbH – Studio für Fotografie · track by track GmbH · iStock · Envato Elements Pty Ltd.

ES Impressum

Editor: Assheuer + Pott GmbH & Co. KG, Talweg 11, 59846 Sundern, Alemania, Tel. +49 2933 97350, info@aps-germany.de, www.aps-germany.de
Diseño gráfico: Assheuer + Pott GmbH & Co. KG - Impresión: Druck- und Verlagshaus Fromm + Rasch GmbH & Co. KG, Breiter Gang 10-16, 49074 Osnabrück, Alemania
Nos reservamos el derecho de efectuar modificaciones en cualquier momento, sin aviso previo. Salvo errores de imprenta o impresión o cambios técnicos. La descripción de los artículos, sus imágenes e ilustraciones son sin garantía. Los artículos se ofrecen sin decoración. Todos los precios indicados son precios sugeridos (PVR) en euros y a dichos precios se deberá añadir el impuesto sobre el valor añadido legal vigente.
© 2023 - Todas las reproducciones, aunque parciales, de este catálogo tienen que ser autorizadas por escrito por Assheuer + Pott GmbH & Co. KG.
Derechos de la imagen: Niklas Thiemann Fotodesign · Stoll GmbH – Studio für Fotografie · track by track GmbH · iStock · Envato Elements Pty Ltd.

FR Impressum

Éditeur: Assheuer + Pott GmbH & Co. KG, Talweg 11, 59846 Sundern, Allemagne, Tel. +49 2933 97350, info@aps-germany.de, www.aps-germany.de
Design: Assheuer + Pott GmbH & Co. KG - Impression: Druck- und Verlagshaus Fromm + Rasch GmbH & Co. KG, Breiter Gang 10-16, 49074 Osnabrück, Allemagne
Nous nous réservons le droit de modifier à tout moment les spécifications. Toutes erreurs, fautes d'impression et modifications techniques sont réservées. Les descriptions d'articles, les illustrations et les photos sont sans garantie. Toutes les articles s'entendent hors décoration. Tous les prix sont donnés sans engagement (PVC) et s'entendent en Euro et T. V. A. légale en vigueur non incluse.
© 2023 - Toute reproduction même partielle de ce catalogue est interdite sauf autorisation expresse de Assheuer + Pott GmbH & Co. KG.
Crédit photo: Niklas Thiemann Fotodesign · Stoll GmbH – Studio für Fotografie · track by track GmbH · iStock · Envato Elements Pty Ltd.



buffet | tabletop | bar

Assheuer + Pott GmbH & Co. KG

Talweg 11 | 59846 Sundern
Germany

Phone: +49 (0) 29 33 / 97 35 - 0
E-Mail: info@aps-germany.de

aps-germany.de

KATALOG NR 49
CATALOG NO 49
CATÁLOGO N° 49
CATALOGUE N° 49



Keep in touch!
aps_germany

no. 3775



4 004133 037755