

VOLLRATH®



pujadas® 2024
A VOLLRATH COMPANY

Pujadas Lab

THE VOLLRATH COMPANY, L.L.C.

1236 North 18th street
Sheboygan, WISCONSIN 53081-3201 USA
Customer Service; 920.459.4851
Fax: 920.459. 6537
Credit: 920.459.5387

VOLLRATH PUJADASSAU

Ctra. de Castanyet, 132
17430 Santa Coloma de Farners
(GIRONA) - SPAIN
Tel. +34 972 84 32 01
info@pujadas.es

VOLLRATH SHANGHAI TRADING LIMITED

Room 906, Building A, Hongwell Plaza, No.1308
Lianhua Road, Minhang District
Shanghai, 201102 CHINA
Tel. 86-21-50589580

VOLLRATH DE MEXICO S. DE R.L. DE C.V.

Periférico Sur edificio 2-C
Col. Santa María Tequepexpan
45601 Tlaquepaque, JALISCO MEXICO
Tel. (52) 333.133.6767 or (52) 333.133.6769
Fax: (52) 333.133.6768

VOLLRATH

www.vollrathfoodservice.com

©2023 The Vollrath Company, L.L.C.
An ISO 9001 Certified Company

STOELTING
A VOLLRATH BRAND

www.stoeltingfoodservice.com

pujadas
A VOLLRATH COMPANY

www.pujadas.es
www.pujadasgrill.com

f @ in v

An ISO 9001 Certified Company

• Live and custom-made demonstrations and trainings

• Showroom with more than 440 m² of exhibition space

• R&D and product development

• *Demostraciones y formaciones en vivo y a medida*

• *Showroom con más de 440 m² de exposición*

• *I+D y desarrollo de producto*

• Des démonstrations et des formations en direct et sur mesure

• Showroom avec surface d'exposition de plus de 440 m²

• R&D et développement de produit

A new versatile, dynamic and welcoming space available to Foodservice professionals.

Un espacio versátil y dinámico a disposición de los profesionales del Foodservice.

Un nouvel espace polyvalent, dynamique et accueillant à la disposition des professionnels du Foodservice.



VOLLRATH®

Founded in 1874, today, Vollrath remains a growing family business. Headquartered in Sheboygan, Wisconsin, with plants in the United States, Europe, Mexico, and China. The Vollrath Company is highly regarded for high-quality engineering and manufacturing. The company's business divisions encompass business operations of foodservice, frozen treat equipment, manufacturing services, and industrial cleaning equipment.

The Vollrath Company has a diverse set of resources with production, warehouse, and sales facilities around the world, as well as an international network of distributors. Vollrath drives continuous improvement in the industries it serves by being at the forefront of the group, and is recognized for leadership in its various industries with the products, services, and support it offers.

Fundada en 1874. Vollrath sigue siendo una empresa familiar en crecimiento. Con sede en Sheboygan, Wisconsin, y con plantas en Estados Unidos, Europa, México y China. The Vollrath Company es reconocida por su ingeniería y fabricación de gran calidad. Sus divisiones de negocio abarcan operaciones comerciales en Foodservice, servicio de fabricaciones personalizadas y equipos de limpieza.

The Vollrath Company cuenta con varias instalaciones de producción, almacenes y ventas en todo el mundo, así como una red internacional de distribuidores. Vollrath impulsa la mejora continua de las industrias a las que sirve estando al frente del grupo y es reconocido por el liderazgo en sus diversas industrias con los productos, servicios y soporte que ofrece a sus clientes.

Fondée en 1874. Aujourd'hui, Vollrath reste une entreprise familiale en pleine croissance. Basée à Sheboygan, dans le Wisconsin, avec des usines aux États-Unis, en Europe, au Mexique et en Chine, The Vollrath Company est très appréciée pour son ingénierie et sa fabrication de haute qualité. Les divisions commerciales de la société, englobent : Foodservice, fabrication personnalisée et équipements de nettoyage.

The Vollrath Company possède plusieurs installations de production, de stockage et de ventes dans le monde entier, ainsi qu'un réseau international de distributeurs. Vollrath favorise l'amélioration continue des industries qu'elle fournit car elle est à la tête du groupe et est reconnue pour sa place de leadership dans ses diverses industries avec les produits, les services et l'assistance qu'elle offre à ses clients.

Our legacy and continued success is based on providing value with innovative, efficient & high-quality products that stand the test of time and are trusted by chefs around the world.

- In-house design consulting
- Custom product fabrication for one-of-a-kind needs
- Easy access to customer and technical service teams that care about your products as much as you do
- Sales force that understands your local culture and clientele, and can recommend products that make sense for your unique needs
- Sustainability as a major company focus

Nuestro legado y éxito continuo se basa en aportar valor con productos innovadores, eficientes y de alta calidad que resisten el paso del tiempo y en los que los chefs de todo el mundo confían.

- Asesoría interna para desarrollo de proyectos
- Fabricación de productos personalizados y adaptados a necesidades únicas
- Customer Service y Servicio Técnico que velan por sus productos tanto como usted
- Fuerza de ventas conocedora de las peculiaridades de los diferentes mercados para recomendar productos que se adapten a cada necesidad
- Sostenibilidad como principal foco para la empresa

Notre legs et notre succès continu reposent sur la valeur ajoutée qu'offrent nos produits innovants, efficaces et de haute qualité, qui résistent au passage du temps et auxquels font confiance les chefs du monde entier.

- Conseil interne au développement de projets
- Fabrication de produits personnalisés et adaptés à des besoins uniques
- Service au client et service technique qui veillent à vos produits autant que vous
- Force de vente connaissant les particularités des différents marchés pour recommander des produits qui s'adaptent à chaque besoin
- Durabilité comme cible principale de l'entreprise



VOLLRATH INTERNATIONAL

Vollrath International was born with the mission of offering global solutions in professional catering, through an agile and efficient production and distribution structure, which achieves a worldwide presence.

Vollrath international nace con la misión de ofrecer soluciones globales en la restauración profesional, a través de una estructura de producción y distribución ágil y eficiente que alcanza una presencia mundial.

Vollrath international est né avec la mission d'offrir des solutions globales dans la restauration professionnelle, grâce à une structure de production et de distribution agile et efficace qui atteint une présence mondiale.

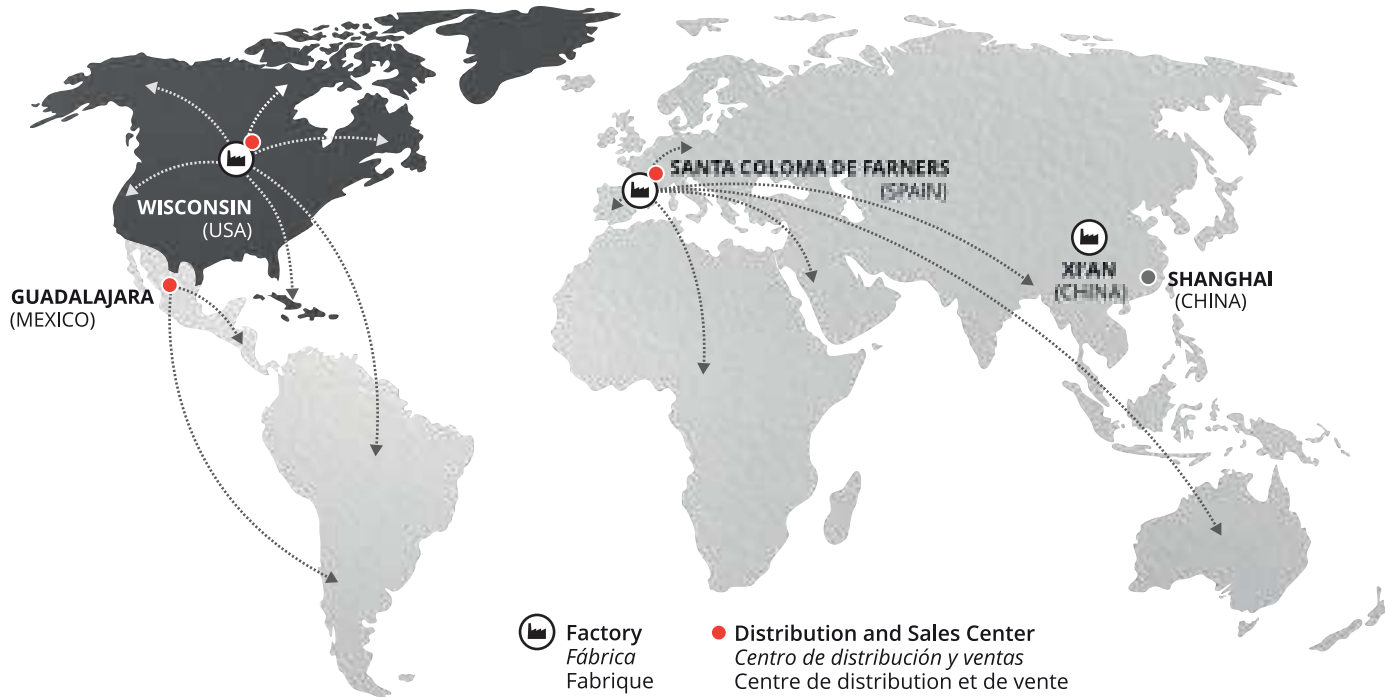

Sales strategy

Estrategia de ventas
Stratégie de soldes



Centers of distribution

Centros de distribución
Les centres de distribution



Orders & billing

Pedidos y facturación
Commandes et facturation

Selling through trusted distributors continues to be the key strategy in marketing the products and services offered by Vollrath International.

La venta a través de distribuidores de confianza sigue siendo la estrategia clave en la comercialización de los productos y servicios que ofrece Vollrath International.

La vente par l'intermédiaire de distributeurs de confiance continue d'être la stratégie clé dans la commercialisation des produits et services offerts par Vollrath International.

With a large stock of products located in our warehouses in Spain, the United States and Mexico, we deliver orders to our entire network of distributors with maximum logistical efficiency.

Con un amplio stock de productos ubicados en nuestros almacenes en España, Estados Unidos y México, servimos a nuestra amplia red de distribuidores con la máxima eficiencia logística.

Avec un large stock de produits situés dans nos entrepôts en Espagne, aux États-Unis et au Mexique, nous livrons les commandes à l'ensemble de notre réseau de distributeurs avec une efficacité logistique maximale.

Thanks to centralized order management, we offer the most efficient customer service responding in less than 24 hours.

Gracias a una gestión de pedidos centralizada ofrecemos el más eficiente servicio al cliente dando respuesta en menos de 24 horas.

Grâce à une gestion centralisée des commandes, on offre le service client le plus efficace répondant en moins de 24 heures.

The global partner with your trusted brands

El partner global con tus marcas de confianza
Le partenaire mondial avec vos marques de confiance



Expansive footprint

ADN de fabricante
ADN du fabricant

Production facilities and storage of
Instalaciones de producción y almacenamiento de
Installations de production et stockage de

90.000 m²

Global solutions

Soluciones globales
Solutions globales

Product catalog with more than
Catálogo de productos con más de
Catalogue de produits avec plus de

7.000 SKUs

Efficient distribution

Distribución eficiente
Distribution efficace

We distribute to more than
Distribuimos a más de
Nous distribuons à plus de

100 countries
países
pays

Trusted by large partners

Grandes marcas confían en nosotros
De grandes marques nous accordent leur confiance





By maintaining the same values as when we started, 100 years ago, we combine wisdom and passion, with technology and innovation to provide our clientele with the best gastronomic experience.

In our 22.000 m² facilities we manufacture kitchenware, storage systems, transport and equipment, as well as the new range of Pujadas Grill ovens.

Our wide range of innovative products, efficient systems and versatile designs means that customers all over the world trust the Pujadas brand to equip their kitchens, halls and buffets.

Since 2015 we have been part of the Vollrath Group, a world leader with which we reach more than 100 countries. This year also sees the birth of a new structure with which Pujadas, together with Vollrath USA, aims to consolidate and expand its presence worldwide.

Manteniendo los valores de cuando empezamos, hace más de 100 años, combinamos la sabiduría y la pasión con la tecnología y la innovación para que nuestros clientes disfruten de la mejor experiencia gastronómica.

En nuestras instalaciones de 22.000 m² fabricamos menaje, sistemas de almacenaje, transporte y equipamiento, así como la nueva gama de hornos de brasa Pujadas Grill.

Nuestro amplio catálogo de productos innovadores, sistemas eficientes y diseños versátiles hace que clientes de todo el mundo confíen en la marca Pujadas para equipar sus cocinas, salas y buffets.

Desde 2015 formamos parte del grupo Vollrath, líder mundial con el que llegamos a más de 100 países. Este año, además, nace una nueva estructura con la que Pujadas, junto con Vollrath USA, aspira a consolidar y ampliar su presencia a nivel mundial.

En conservant les valeurs qui étaient les nôtres lors de notre création, il y a plus de 100 ans, nous associons le savoir-faire et la passion à la technologie et à l'innovation pour aider nos clients à bénéficier de la meilleure expérience gastronomique.

Dans nos installations de 22.000 m², nous fabriquons du matériel de cuisine, des systèmes de stockage, des moyens de transport et des équipements, ainsi que la nouvelle gamme de fours à braise Pujadas Grill.

Grâce à notre vaste catalogue de produits innovants, de systèmes efficaces et de designs polyvalents, nos clients du monde entier font confiance à la marque Pujadas pour équiper leurs cuisines, leurs salles et leurs buffets.

Depuis 2015, nous faisons partie du groupe Vollrath, leader mondial avec lequel nous sommes présents dans plus de 100 pays. En outre, cette année, Pujadas a mis en place une nouvelle structure qui lui permettra, avec Vollrath USA, de consolider et d'accroître sa présence au niveau mondial.

We are manufacturers

Somos fabricantes
Nous sommes fabricants

Since 1921, we have been manufacturing highly competitive, durable and efficient products that guarantee the sustainability of every type of business.

Desde 1921 fabricamos productos altamente competitivos, durables y eficientes que velan por la rentabilidad de cada tipo de negocio.

Depuis 1921, nous fabriquons des produits extrêmement compétitifs, durables et efficaces qui contribuent à la rentabilité de chaque type d'entreprise.



We implement more efficient and sustainable production processes, always following strict quality protocols.

Implementamos procesos productivos más eficientes y sostenibles, siempre siguiendo estrictos protocolos de calidad.

Nous mettons en œuvre des processus de production plus efficaces et plus durables, en respectant toujours des protocoles de qualité stricts.



Food Contact Approved

Apto para contacto con alimentos

Adapté au contact alimentaire



Public Health and Safety

Organización para la Salud y Seguridad Pública

Santé et Sécurité Publiques



Quality System

Sistema de Calidad

Système de management de la Qualité



Quality System

Sistema de Calidad

Système de management de la Qualité



Guaranteed for life

Garantía de por vida

Garantie à vie



Bolsas hechas de materiales 100% reciclados

Bolsas hechas de materiales 100% reciclados

Bolsas hechas de materiales 100% reciclados



Thanks to the quality, dependability and performance of our equipment, along with an experienced sales & customer support staff, Stoelting has earned a strong reputation as a top manufacturer of frozen treat equipment.

We offer a full line of products that make your business more efficient, streamlining and profitable.

Gracias a la calidad, la seguridad y el rendimiento de nuestros equipos, Stoelting se ha ganado una sólida reputación como uno de los principales fabricantes de máquinas de productos helados.

Ofrecemos una línea completa de productos para que el negocio sea más eficiente, ágil y rentable.

Grâce à la qualité, à la sécurité et au rendement de ses équipements, Stoelting s'est forgé une solide réputation en tant que l'un des principaux fabricants de machines de produits glacés.

Nous proposons une gamme complète de produits pour que votre entreprise soit plus efficace, plus souple et plus rentable.



Pujadas Grill, the complete experience for your grilled creations.

- **Wide range of ovens, designed and manufactured in Pujadas.**
- **Accessories, cookware and complements for grilling.**
- **Range for different smoking techniques.**
- **Commissioning and after-sales support services.**
- **Extensive network of strategically distributed chef ambassadors.**
- **Preferred Distributors.**

Pujadas Grill, la experiencia completa para tus creaciones a la brasa.

- **Amplia gama de hornos, diseñados y fabricados en Pujadas.**
- **Accesorios, menaje y servicio de mesa para cocina a la brasa.**
- **Gama para diferentes técnicas de ahumados.**
- **Servicio de puesta en marcha y posventa.**
- **Amplia red de chefs embajadores estratégicamente distribuidos.**
- **Distribuidores preferenciales.**

Pujadas Grill, l'expérience complète pour vos créations à la braise.

- **Large gamme de fours, conçus et fabriqués par Pujadas.**
- **Accessoires, batterie de cuisine et arts de table spécial pour cuisiner à la braise.**
- **Gamme de produits pour différentes techniques de fumage.**
- **Un service de mise en oeuvre et de service après-vente.**
- **Un vaste réseau de chefs ambassadeurs répartis de manière stratégique.**
- **Distributeurs préférentiels.**

N **New**
Novedades
Nouveauté

1 **Grill**
Brasa
Braise

2 **Cookware**
Batería de Cocina
Batterie de Cuisine

3 **Fry pans**
Sartenes
Poêles

4 **Oven and
 roast pan**
Horno y rustideras
Four et plaques à rôtir



1.1 GRILLBOX	26
1.2 CHARCOALOSENS <i>HORNO DE BRASA</i> <i>FOUR À BRAISE</i>	29
1.3 SMOKER <i>AHUMADOS</i> <i>FUMÉS</i>	32
1.4 ACCESSORIES <i>ACCESORIOS</i> <i>ACCESSOIRES</i>	34
1.5 GRILLCOOKWARE <i>MENAJE BRASA</i> <i>MATÉRIEL À BRAISE</i>	36

2.1 TRIBUTE	42
2.2 INOX-PRO	46
2.3 COOL-LINE	54
2.4 CENTURY	56
2.5 BLACKSERIES	60
2.6 BLACKFORGED	61

3.1 WEAR EVER <i>ALUMINIUM</i> <i>ALUMINIO</i>	68
3.2 TRIBUTE <i>MULTI-PLY</i> <i>MULTIMETAL</i>	69
3.3 ST/STEEL <i>ACERO INOXIDABLE</i> <i>ACIER INOXYDABLE</i>	70
3.4 ALUMINIUM <i>ALUMINIO</i> <i>ALUMINIUM</i>	73
3.5 MULTI-PLY <i>MULTIMETAL</i> <i>MULTI-METAL</i>	77
3.6 CASTALUMINIUM <i>ALUMINIO FUNDICIÓN</i> <i>FONT D'ALUMINIUM</i>	76
3.7 STEEL <i>ACERO</i> <i>ACIER</i>	81
3.8 SPANISHPAELLAPAN <i>PAELLERA</i> <i>PLAT À PAELLA</i>	84

4.1 ROASTPANS <i>RUSTIDERAS</i> <i>PLAQUES À RÔTIR</i>	88
4.2 GASTRONORM SHEETPANS <i>BANDEJAS HORNO GASTRONORM</i> <i>PLAQUES FOUR GASTRONORME</i>	89
4.3 PASTRYTRAYS <i>BANDEJAS PASTELERÍA</i> <i>PLAQUES À PÂTISSERIE</i>	90
4.4 GRIDS <i>REJILLAS</i> <i>GRILLES</i>	92
4.5 PIZZABAKINGSHEETS <i>BANDEJAS PARA PIZZA</i> <i>PLAQUES À PIZZA</i>	93
4.6 OVENACCESSORIES <i>ACCESORIOS HORNO</i> <i>ACCESSOIRES FOUR</i>	95

Index

5 Kitchen utensils

Utensilios de cocina
Ustensiles de cuisine



- 5.1 KITCHEN UTENSILS** 98
UTENSILIOS DE COCINA
USTENSILES DE CUISINE
- 5.2 MANUAL FOOD PROCESSORS** 125
PROCESADORES MANUALES DE ALIMENTOS
APPAREILS MANUELS DE TRANSFORMATION DES ALIMENTS
- 5.3 CUTTINGBOARDS** 140
TABLAS DE CORTE
PLANCHES À DÉCOUPER
- 5.4 MEASURING UTENSILS** 143
ELEMENTOS DE MEDIDA
USTENSILES DE MESURE
- 5.5 MITT** 149
MANOPLA
GAN
- 5.6 NATURAL RUBBER MATS** 149
ALFOMBRAS CAUCHO
TAPIS EN CAOUTCHOUC

6 Ice-cream utensils & pastry

Heladería y pastelería
Ustensiles à glace et pâtisserie



- 6.1 ICE-CREAM UTENSILS** 152
UTENSILIOS HELADERÍA
USTENSILES POUR GLACE
- 6.2 PASTRY UTENSILS** 154
UTENSILIOS DE PASTELERÍA
USTENSILES DE PÂTISSERIE
- 6.3 NON-STICK MOULDS** 163
MOLDES ANTIADHERENTES
MOULES ANTI-ADHÉSIFS
- 6.4 PASTRY CUTTER** 166
CORTAPASTAS
DÉCOUPOIRS
- 6.5 ST/STEEL PASTRY MOULDS** 167
MOLDES ACERO INOXIDABLE
MOULES EN ACIER INOX
- 6.6 BAGS AND TUBES** 170
MANGAS Y BOQUILLAS
POCHES ET DOUILLES
- 6.7 FLEXIPAN MOULDS** 175
MOLDES FLEXIPAN
MOULES FLEXIPAN
- 6.8 SILICONE MOULDS** 182
MOLDES SILICONA
MOULES SILICONE

7 Gastronorm containers

Cubetas gastronorm
Bacs gastronorme



- 7.1 GN PRO** 194
18/10 ST / STEEL
INOX 18/10
- 7.2 GASTRONORM ACCESSORIES** 198
COMPLEMENTOS GASTRONORM
ACCESSOIRES GASTRONORME
- 7.3 WITH SANDWICH BOTTOM** 199
CON FONDO DIFUSOR
AVEC FOND THERMO-DIFFUSEUR
- 7.4 SUPERPAN 3** 200
- 7.5 POLYCARBONATE** 202
POLICARBONATO
POLYCARBONATE
- 7.6 BISPHENOL-A FREE** 204
SIN BISFENOL-A
SANS BISPHÉNOL-A
- 7.7 POLYPROPYLENE** 206
POLIPROPILENO
POLYPROPYLÈNE
- 7.8 VIOLET COLLECTION** 208

8 Food delivery

Transporte de alimentos
Transport d'aliments



- 8.1 EPPBOX** 212
CAJA PPE
BOÎTE PPE
- 8.2 INSULATED DELIVERY BAGS** 214
BOLSA DE REPARTO
SACS DE LIVRAISON ISOTHERMES
- 8.3 TRAYS AND CONTAINERS** 220
BANDEJAS Y RECIPIENTES
PLATEAUX ET PLATS

9 Dishwasher racks

Cestas para vajilla
Cassiers à vaisselle



- 9.1 OPENED RACKS** 230
CESTAS ABIERTAS
CASIERS OUVERTS
- 9.2 OPENED ASSEMBLED RACKS** 232
CESTAS MONTADAS ABIERTAS
CASIERS MONTÉS OUVERTS
- 9.3 CLOSED ASSEMBLED RACKS** 234
CESTAS MONTADAS CERRADAS
CASIERS MONTÉS FERMÉS
- 9.4 COMPLEMENTS** 236
COMPLEMENTOS
COMPLÈMENTS
- 9.5 PLATERACKS** 238
CESTAS PARA PLATOS
CASIERS ASSIETTES

10 Trolleys

Carros
Chariots



- 10.1 ALUMINIUM SERVING TROLLEYS** 244
CARROS DE SERVICIO ALUMINIO
CHARIOTS DE SERVICE EN ALUMINIUM
- 10.2 ST/STEEL SERVING TROLLEYS** 246
CARROS DE SERVICIO ACERO INOXIDABLE
CHARIOTS DE SERVICE EN ACIER INOXYDABLE
- 10.3 ST/STEEL RAIL TROLLEYS** 250
CARROS GUÍAS EN ACERO INOXIDABLE
CHARIOTS À GLISSIÈRE EN ACIER INOXYDABLE
- 16.4 SPECIAL TROLLEYS** 257
CARROS ESPECIALES
CHARIOTS SPÉCIAUX

11 Shelving

Estanterías
Rayonnages



- 11.1 COMPLETE AND ANGULAR SHELVING** 267
ESTANTERÍAS COMPLETAS Y ANGULARES
RAYONNAGES COMPLETS ET ANGULAIRES
- 11.2 SHELVING WITH WHEELS** 274
ESTANTERÍAS CON RUEDAS
RAYONNAGES AVEC ROUES
- 11.3 BENCH** 274
BANCADAS
BANCS
- 11.4 PARTS** 275
COMPONENTES
COMPOSANTS
- 11.5 BREAKDOWN OF SHELVING SETS** 278
DESGLOSE CONJUNTOS DE ESTANTERÍAS
DÉCOMPOSITION KITS RAYONNAGES

12 Equipment

Maquinaria
Équipement



- 12.1 COOKING** 288
COCCIÓN
COUSSION
- 12.2 TOASTERS & CONTACT GRILLS** 296
TOSTADORAS Y GRILL DE CONTACTO
TOASTEURS ET GRILL DE CONTACT
- 12.3 FOOD PROCESSORS** 302
PROCESADORES DE ALIMENTOS
ROBOTS MULTIFONCTION
- 12.4 FOOD WARMING EQUIPMENT** 304
MAQUINARIA MANTENEDORA DE TEMPERATURA
APPAREILS DE MAINTEN DE TEMPEÉRATURE
- 12.5 ICE-CREAM MACHINES** 322
MAQUINARIA HELADERÍA
TURBINES À GLACE

13 Melamine

Melamina y presentación
Melamine et présentation



- 13 MELAMINE** 330
MELAMINA Y PRESENTACIÓN
MELAMINE ET PRÉSENTATION

14 Buffet & Accessories

Buffet y accesorios
Buffet et accessoires



- 14.1 DISPLAY STANDS & BASKETS** 386
PRESENTACIÓN Y EXPOSITORES
PRÉSENTOIRS ET PRÉSENTOIRS
CORBEILLES
- 14.2 PROTECTION AND COVERS** 394
PROTECCIÓN Y TAPAS
PROTECTION ET COUVERCLES
- 14.3 BRONZE COOKWARE** 398
BATERÍA DE COCINA BRONCE
BATTERIE DE CUISINE BRONZE
- 14.4 COOL-LINE COLLECTION** 400
- 14.5 SUPER SHAPES** 402
BUFFET PRESENTATION STEAM TABLE PANS
CUBETAS PRESENTACIÓN BUFFET
BACS PRÉSENTATION BUFFET
- 14.6 MIRAMAR® COOKWARE** 406
BATERÍA DE COCINA PARA PRESENTACIÓN
BATTERIE DE CUISINE PRÉSENTATION
- 14.7 CUBIC** 412
- 14.8 CHAFERS & DISPENSERS** 428
CHAFINGS Y DISPENSADORES
CHAFERS ET DISTRIBUTEURS
- 14.9 BOWLS & SERVING TRAYS** 436
BOLS & BANDEJAS DE SERVICIO
BOLS & PLATEAUX
- 14.10 SERVING TOOLS** 440
UTENSILIOS DE SERVICIO
USTENSILES DE SERVICE BUFFET
- 14.11 SIGNS** 450
SEÑALIZACIÓN / SIGNALIZATION

15 Table Service

Servicio de mesa
Arts de table



- 15.1 MINIATURES** 454
MINIATURAS
MINIATURES
- 15.2 TABLE PRESENTATION** 462
PRESENTACIÓN DE MESA
PRÉSENTATION TABLE
- 15.3 TABLE SERVICE** 479
SERVICIO DE MESA
SERVICE DE TABLE

16 Bar & Coffee

Barycaféteria
Bar et cafétéria



- 16.1 BEVERAGE TROLLEY** 488
CARRO BEBIDAS
TCHARIOT BOISSON
- 16.2 BAR** 491
- 16.3 TEA & COFFEE SERVICE** 502
TÉ Y CAFETERÍA
THÉ ET CAFÉTERIA
- 16.4 BEVERAGE SERVICE** 506
SERVICIO DE BEBIDAS
SERVICE À BOISSONS
- 16.5 LIDS AVERS AND CUP DISPENSERS** 510
DISPENSADORES DE TAPAS Y VASOS
DISTRIBUTEUR DE COUVERCLES
ET GOBELETS

N **New**
 Novedades
 Nouveauté

P Grill



P. 27



P. 28



P. 32



P. 33



P. 30



P. 29



Tribute



P. 42

4-Series



P. 289

Easy open



P. 197

STOELTING
 A VOLLRATH BRAND

Ice-cream and beverage solutions
 Soluciones para la heladería
 Solutions pour glaciers



P. 322



P. 255



P. 257

Melamine



P. 336



P. 337



P. 338



P. 335



P. 334



P. 341



P. 340



P. 339



P. 342



P. 462

Buffet



P. 398



P. 386



P. 388



P. 459



P. 458

Beverage trolley



P. 470



P. 357



P. 490



P. 488



P. 480



P. 454



P. 491

1 Grill

Brasa
Braise



1.1 GRILLBOX 26

1.2 CHARCOAL OVENS 29
HORNO DE BRASA
FOUR À BRAISE

1.3 SMOKER 32
AHUMADOS
FUMÉS

1.4 ACCESSORIES 34
ACCESORIOS
ACCESSOIRES

1.5 GRILLCOOKWARE 36
MENAJE BRASA
MATÉRIEL À BRAISE

Oven operation

Funcionamiento horno
Fonctionnement du four

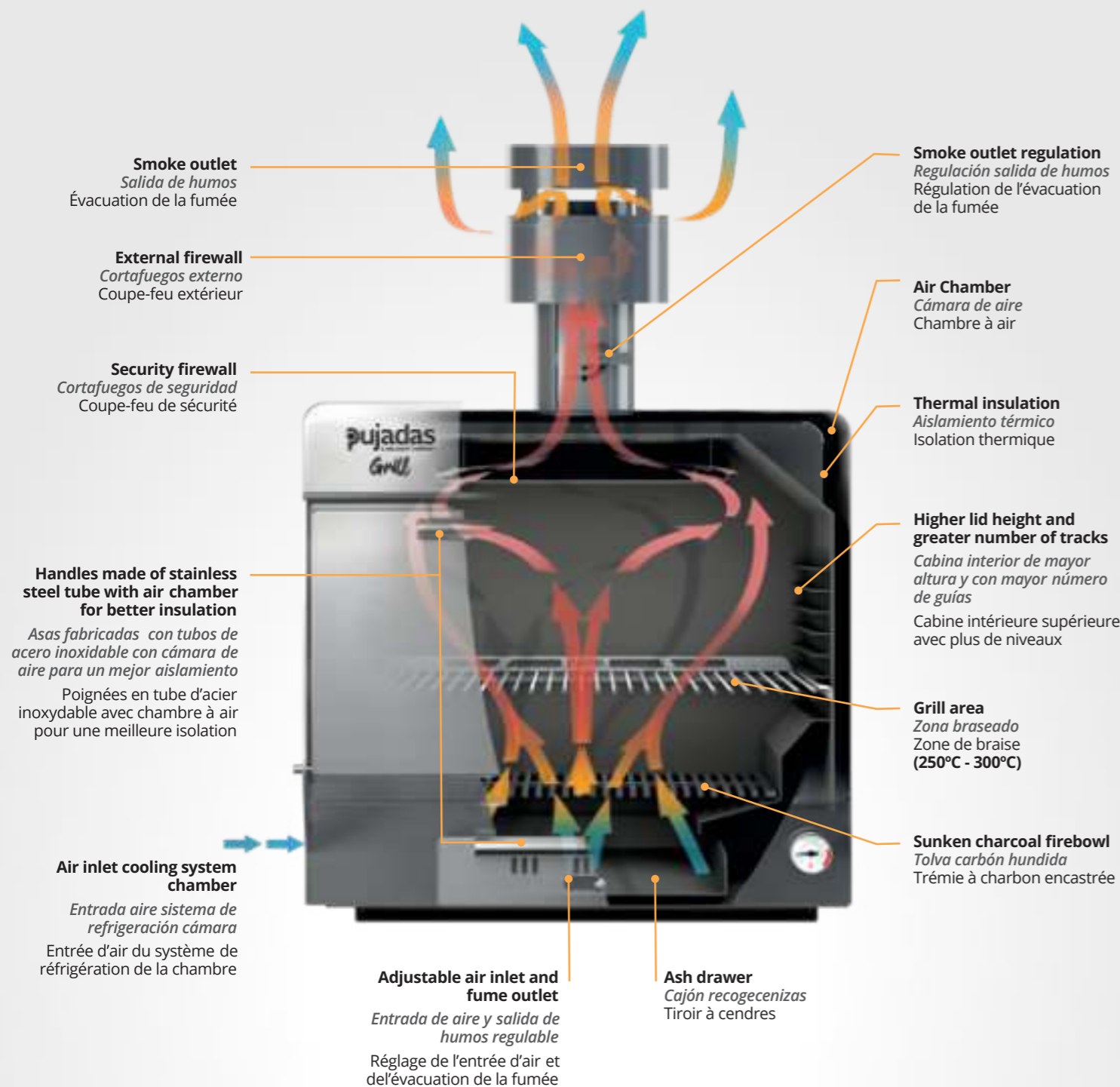

- Greater power and efficiency. A way to cook faster, cleaner and healthier.
- No need to connect to a power source.
- Depending on the number of services, improves the energy cost.
- The high calorific value of charcoal increases its efficiency: with a small amount of charcoal, the temperature increases quickly and reaches a point suitable for cooking in less than 10 minutes.
- Allows you to control the cooking temperature thanks to the upper and lower air flow regulators.
- Fast return on investment (2.5 years approximately).

- Mayor potencia y eficiencia. Una forma de cocinar más rápida, limpia y saludable.
- No es necesario conectar a la corriente.
- Según el número de servicios, mejora el coste de la energía.
- El alto poder calorífico del carbón incrementa su eficiencia: con poca cantidad de carbón aumenta la temperatura rápidamente y llega al punto apto para cocción en menos de 10 minutos.
- Permite controlar la temperatura de cocción gracias a los reguladores de caudal de aire superior e inferior.
- Rápido retorno de la inversión (2,5 años aproximadamente).

- Puissance et efficacité accrues. Une façon de cuisiner plus rapide, plus propre et plus saine.
- La connexion à l'alimentation n'est pas nécessaire.
- Selon le nombre de services, réduit la dépense énergétique.
- Le haut pouvoir calorifique du charbon augmente son efficacité : une petite quantité de charbon suffit pour augmenter la température rapidement et atteindre le point de cuisson approprié en moins de 10 minutes.
- Permet de contrôler la température de cuisson grâce aux régulateurs de débit d'air supérieur et inférieur.
- Retour sur investissement rapide (2,5 ans environ).



Comparison of consumption according to energy source

Comparativa de consumo según fuente energética
Comparaison des consommations selon la source d'énergie

OVEN TYPE TIPO HORNO TYPE FOUR	Dimensiones Dimensions Dimensions cm (W x D x H)	Power Potencia Puissance KW	Consumption Consumo Consommation	Cost Gasto Dépense € / hour / hora / heure	Difference Diferencia Différence PJD OVEN 90	Difference Diferencia Différence PJD OVEN 140
ELECTRIC ELÉCTRICO ÉLECTRIQUE	90 x 68 x 80	6	6 KW/h	1,01	-36%	-10%
GAS GAS GAZ	90 x 68 x 80 73 x 60 x 80 86 x 62 x 80	8	0,85 m ³	1,12	-42%	-19%
CHARCOAL CARBÓN À BRAISE	OVEN 90 69 x 66 x 72	10,8 (Marabú)	5 kg / 4h	0,65	-	-
CHARCOAL CARBÓN À BRAISE	OVEN 140 87 x 86 x 87	15,1 (Marabú)	7 Kg / 4h	0,91	-	-

Calculations may vary according to the energy tariffs in different countries
Los cálculos pueden variar según las tarifas energéticas de los diferentes países
Les calculs peuvent varier en fonction du prix de l'énergie des différents pays.

1.1 GRILLBOX



Just the way you like it

A tu gusto, a tu ritmo / À votre goût, à votre rythme

High-quality stainless steel mini grill
Mini parrilla acero inox de alta calidad
Mini grill acier inox de haute qualité

Charcoal container
Carbonera
Espace charbon

High-quality stainless steel reinforced casing.
Prevents heat leakage during preparation.
Carcasa reforzada acero inox de alta calidad.
Impide la fuga de calor durante la preparación.
Carcasse renforcée en acier inoxydable de haute qualité.
Empêche la perte de chaleur pendant la préparation.

High-quality stainless-steel base.
Low weight for easy transport.
Base de acero inox de alta calidad.
Peso reducido para facilitar su transporte.
Base en acier inoxydable de haute qualité.
Poids léger pour faciliter son transport.



P85200 Stainless steel tabletop barbecue
Barbacoa sobremesa acero inox
Barbecue de table acier inox



REF	W x D x H cm	
P85200	37 x 26 x 15	1

P85220 Stainless Steel tabletop barbecue Duo
Barbacoa de sobremesa Duo acero inoxidable
Barbecue de table Duo en acier inoxydable

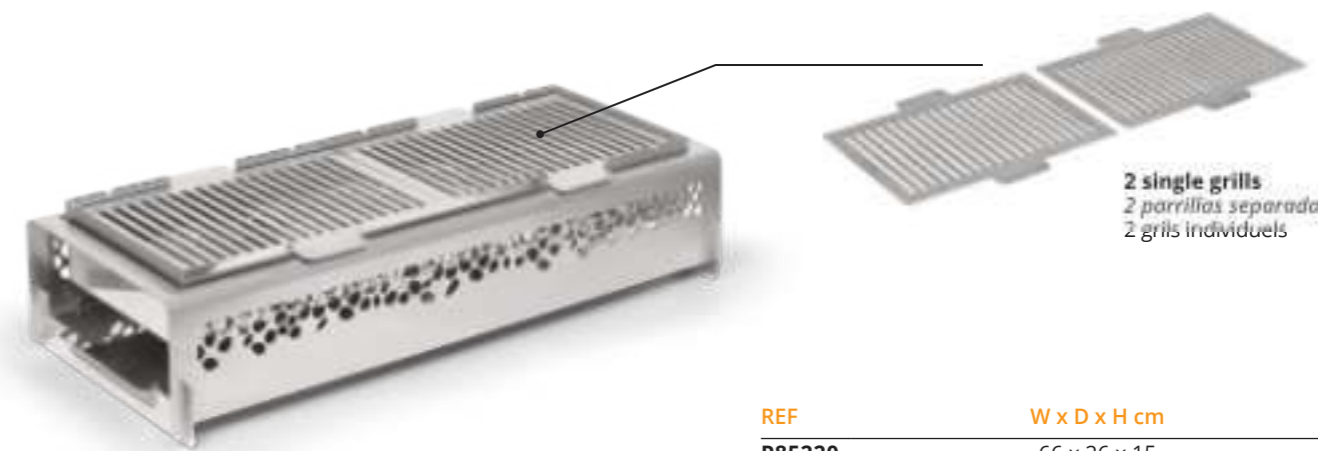

2 single grills
2 parrillas separadas
2 grils individuels

REF	W x D x H cm	
P85220	66 x 26 x 15	1

1.1 GrillBox



Optional accessories
Complementos opcionales
Accessoires en option

P2960001 **Stainless steel tray**
Llauna inox
Plaque inox



REF	W x D x H cm	
P2960001	29,3 x 19,3 x 2	1

P85201 **Basalt stone**
Piedra de basalto
Pierre de basalte



REF	W x D x H cm	
P85201	28,7 x 18,7 x 2	1

P968130 **Skewer**
Pincho
Brochette



12 units box
Caja 12 unidades
Colis 12 unités

REF	L cm	
P968130	30	12

P85223 **Gripper**
Pala
Pelle



REF	L cm	
P85223	30	12

P85222 **GrillBox lid**
Tapa GrillBox
Couvercle GrillBox



REF	W x D x H cm	
P85222	29,7 x 19,6 x 11,2	1

All accessories suit to GrillBox and GrillBox Duo
Todos los accesorios se adaptan a GrillBox y GrillBox Duo
Tous les accessoires sont compatibles avec GrillBox et GrillBox Duo

Charcoal ovens 12

Horno brasa
Four à braise



MADE OF HIGH-QUALITY STAINLESS STEEL
FABRICADOS EN ACERO INOXIDABLE DE ALTA CALIDAD
FAITS D'ACIER INOXYDABLE DE HAUTE QUALITÉ

OVEN50



40 - 50
diners
comensales
couverts

OVEN90



80 - 90
diners
comensales
couverts

OVEN140



130-140
diners
comensales
couverts

REF	Dimensions Dimensiones cm (W x D x H)	Grill Parrilla Gril cm	Produc. Kg/h	Temp. Rec. Cooking Temp. rec. cocción Temp. réch. cuisson. °C	Power Equiv. Pot. Equiv. Puiss. Équiv. KW	Consum. Consumo Consum. Kg/ day / día / jour	Charcoal load Carga carbón Charge de charbon Kg	Weight Peso Poids Kg	Colour Color Couleur	
OVEN50	P85050SS									
	P85050R	69 x 57 x 62	58 x 36,7 x 20	30	250-350	3.2	6 (Marabú)	5	145	1
	P85050B									
OVEN90	P85090SS									
	P85090R	69 x 66 x 72	58 x 46,7 x 20	70	250-350	4	10,8 (Marabú)	7	180	1
	P85090B									
OVEN140	P85140SS									
	P85140R	87 x 86 x 87	76,6 x 64,8 x 20	100	250-350	4.6	15,1 (Marabú)	9	240	1
	P85140B									

Each oven comes with

Cada horno se entrega con /Chaque four est livré avec:



• 1 stainless steel grill
• 1 parrilla de acero inoxidable
• 1 grille en acier inoxydable

• 1 tong
• 1 pinza
• 1 pince

• 1 ash shovel
• 1 pala recoge cenizas
• 1 pelle pour ramasser les cendres

• 1 charcoal poker
• 1 atizador de carbón
• 1 tisonnier à charbon

• 1 metallic brush
• 1 cepillo metálico
• 1 brosse métallique

1.2 Charcoal ovens

Horno brasa
Four à braise

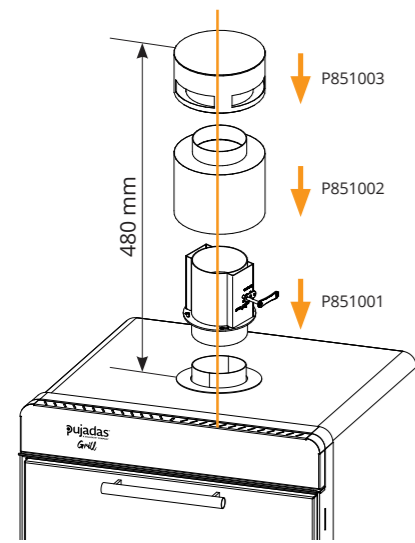

P851003 Hat filter
Filtro sombrero
Filtre chapeau supérieur



REF	Quantity
P851003	1

P851002 External cutter flame
Cortafuegos externo
Coupe-feu externe



REF	Quantity
P851002	1

P851001 Upper air flow regulator
Regulador de tiro superior
Régulateur de sortie de fumée



REF	Quantity
P851001	1

P85050CP Stainless Steel hot plate
Parrilla calentaplatos acero inox
Grille chauffer acier inox

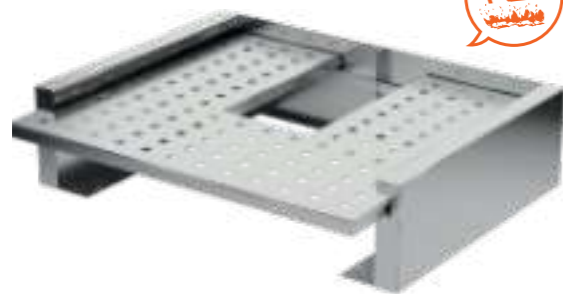

REF	Oven / Horno / Four	W x D x H cm	Quantity
P85050CP	50	67,7 x 46,6 x 18,4	1
P85090CP	90	67,7 x 56,6 x 18,4	1
P85140CP	140	86 x 74,6 x 18,4	1

RE8505004 Stainless steel oven rack
Parrilla varilla inox horno
Grille en acier inoxydable



REF	Oven / Horno / Four	W x D x H cm	Quantity
RE8505004	50	58 x 36,7 x 20	1
RE8509007	90	58 x 46,7 x 20	1
RE8514007	140	76,6 x 64,8 x 20	1

Charcoal ovens 1.2

Horno brasa
Four à braise



P85090 Oven table - Oven 90
Mesa para horno Oven 90
Table pour four Oven 90



P85090MP



P85090MT



Available with wheels
Disponible con ruedas
Disponible avec roues

REF	w/wheels con ruedas avec roues	cm W x D x H	Quantity
P85090MT	x	68,5 x 56,5 x 85	1
P85090MP	x	68,5 x 60,8 x 85	1
P85090MTR	✓	68,5 x 56,5 x 93,5	1
P85090MPR	✓	68,5 x 60,8 x 93,5	1

P85140 Oven table - Oven 140
Mesa para horno Oven 140
Table pour four Oven 140



P85140MP



P85140MT



Available with wheels
Disponible con ruedas
Disponible avec roues

REF	w/wheels con ruedas avec roues	cm W x D x H	Quantity
P85140MT	x	94,5 x 80,5 x 70	1
P85140MP	x	94,5 x 84,7 x 70	1
P85140MTR	✓	94,5 x 80,5 x 78,4	1
P85140MPR	✓	94,5 x 84,7 x 78,4	1

1.3 SMOKER

The smoking technique is a growing trend not only for the culinary preparations of the most prestigious chefs but also for all those who prioritize innovation and originality in their menus.

Easily, quickly and efficiently achieve totally cold smoke, much more aromatic and stable over time, and suitable for sauces, oils, meats, fish, cheeses, rice dishes or even cocktails.

La técnica del ahumado es una tendencia al alza no sólo para las elaboraciones culinarias de los más prestigiosos chefs sino de todos aquellos que priman la innovación y originalidad en sus preparaciones.

Consigue humos totalmente fríos, mucho más aromáticos y estables en el tiempo para tus salsas, aceites, carnes, pescados, quesos, arroces o incluso cocktails de manera fácil, rápida y eficaz.

La technique du fumage est une tendance à la hausse non seulement pour les élaborations culinaires des chefs les plus prestigieux, mais aussi pour tous ceux qui privilégient l'innovation et l'originalité dans leurs préparations.

Obtenez des fumées totalement froides, beaucoup plus aromatiques et stables dans le temps pour vos sauces, huiles, viandes, poissons, fromages, riz ou même cocktails de façon facile, rapide et efficace.

Smoker
Ahumador
Fumoir

Tank for burner
Depósito para quemador
Réservoir pour brûleur

Support for the Gun
Soporte para el aromatizador
Support pour l'aromatiseur

Smoking Valve
Válvula para aromatizar
Vanne aromatisante

Burner
Quegador
Brûleur

*Highly resistant to large-scale work volumes
*Altamente resistente a grandes volúmenes de trabajo
*Très résistante aux grands volumes de travail



PUJADAS KITCHENWARE FOR SMOKING AND FLAVOUR MÉNAJE PUJADAS PARA AHUMAR Y AROMATIZAR USTENSILES DE CUISINE PUJADAS POUR FUMER ET AROMATISER



Food silicone valves with self-closing system that allow the entry of flavoured smoke without leaks, and preserving all food essence.

Válvulas de silicona alimentaria con autocierre que permiten la entrada del humo aromatizado sin fugas/escapes, preservando toda su esencia.

Valves en silicone alimentaire à fermeture automatique qui permettent l'entrée de fumée aromatisée sans fuites / pertes, préservant toute son essence.

Smoker 1.3

Ahumados
Fumoir



P85230 Smoker
Ahumador
Fumoir



REF	W x D x H cm	Box
P85230	5,5 x 12,5 x 16	1

P110004A GN hermetic lid for smoking
Tapa hermética GN para ahumar
Couvercle hermétique GN pour fumer

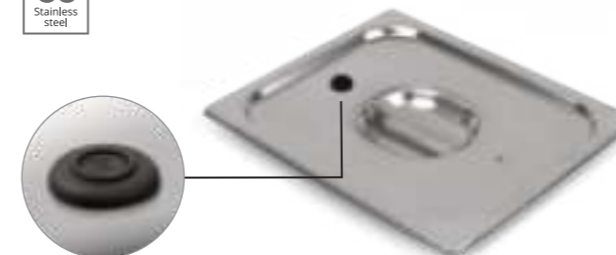

REF	GN	cm	Box
P110004A	1/1	53 x 32,5	1
P120004A	1/2	32,5 x 26,5	1

Ideal for cold smoking large pieces of meat or whole fish. Adaptable to all 1/1 & 1/2 GN containers.

Ideal para ahumar en frío piezas grandes de carne y pescado enteras. Adaptable a todas las cubetas GN 1/1 y 1/2.

Idéal pour fumer à froid de gros morceaux de viande ou poisson entier. Adaptable à Tous les bacs GN 1/1 et 1/2.

P209020A Cookware inox lid for smoke
Tapa batería inox para ahumar
Couvercle de batterie en acier inoxydable pour fumer



REF	Ø cm	Box
P209020A	20	1
P209024A	24	1
P209028A	28	1
P209032A	32	1

Lid with smoke valve for preparations such as sauces, stews, etc.

Tapa con válvula de ahumado para elaboraciones como salsas, cocidos, etc.

Couvercle avec valve de fumage pour les élaborations telles que les sauces, les ragoûts, etc.

P85231 Chips beech and oak
Chips aroma haya y roble
Chips d'arôme de hêtre et de chêne



REF	Ø cm	H cm	gr	Box
P85231	7,5	9	80	1
P85232	7,5	9	80	1

1.4 Accessories

Accesorios
Accessoires

P850000 Charcoal top quality Marabú Carbón vegetal Marabú primera calidad Charbon de bois Marabú de qualité supérieure

- High calorific performance.
- A good mix of lumpwood and broken charcoal pieces.
- Coarse-grained, dust-free charcoal.
- 10 Kg bag with handle for easy transport and handling.
- Bag made of plasticized raffia to prevent soot from escaping.

- Alto rendimiento calorífico.
- Buena mezcla de roturado y canelino.
- Carbón de granulometría gruesa y sin polvo.
- Saco de 10 kg con asa para su fácil transporte y manejo.
- Saco fabricado en rafia plastificada para evitar el escape de hollín.

- Puissance calorifique élevée.
- Bonne proportion de roturado et canelino.
- Charbon grosse granulométrie et sans poussière.
- Sac de 10 kg avec poignée pour un transport et une manipulation faciles.
- Sac fabriqué en raphia plastifié pour éviter la perte de suie.



Sale unit: 1 pallet including 28 10Kg charcoal bags

Unidad de venta: 1 palet 28 sacos de 10Kg. de carbón

Unité de vente: 1 palette 28 sacs de 10Kg. de charbon de bois

REF	Wood type Tipo de madera Type de bois	Calorific value Poder calorífico Puissance calorifique Kcal/Kg	Granulometry Granulometría Granulométrie mm	Carbon Carbón Carbone %	Ashes Cenizas Cendres %	Humidity Humedad Humidité %	Density Densidad Densité Km/m ³	Bag weight Peso saco Poids sac Kg
P850000	Marabú	≈ 8000	150	> 75	< 5	< 6	298	10

P850101 Oak chunks Tacos de madera de roble Morceaux de chêne



REF	Kg	
P850101	± 4	1

P850102 Sherry aromatic oak chips Astillas de roble con aroma fino Copeaux de chêne à l'arôme de xérès



Chips from authentic macerated barrel
Astillas de auténtica barrica macerada
Copeaux d'authentiques barriques macérées

REF	Kg	
P850102	± 2	1

P850104 Whisky aromatic oak chips Astillas de roble con aroma whisky Copeaux de chêne à l'arôme de whisky



Chips from authentic macerated barrel
Astillas de auténtica barrica macerada
Copeaux d'authentiques barriques macérées

REF	Kg	
P850104	± 2	1

100% natural
100% natural / 100 % naturel

Add subtle nuances and aromas to your recipes with the age-old technique of smoking. Aromatize the embers before starting with the elaboration so your dishes will get new tastes.

Agrega sutiles matices y aromas a tus recetas con la técnica milenaria del ahumado. Aromatiza la brasa antes de empezar con la elaboración, así tus platos conseguirán nuevos sabores que sorprenderán.

Ajoutez des nuances et des arômes subtils à vos recettes grâce à la technique ancestrale du fumage. Parfumez les braises avant de commencer la cuisson, de cette façon vos plats obtiendront de nouveaux arômes et goûts.

Accessories 1.4

Accesorios
Accessoires

P851004 Heavy duty oven tong Pinza reforzada horno Pince renforcée pour four



REF	cm	
P851004	33,5	120

P851007 Metallic brush Cepillo metálico Brosse métallique



REF	L cm	
P851007	23,5	1
RE851008	23,5	1

P851005 Oven poker Pala atizadora horno brasa Tisonnier pour four à braise



REF	cm	
P851005	64,5	1

P851006 Collect ashes shovel Pala recogecenizas Pelle à cendres



REF	W x D x H cm	
P851006	14,5 x 38,5 x 13	1

478 Stainless steel tong Pinza de acero inoxidable Pince inoxydable



REF	L cm	
4781210	30,5	12
4781610	40,6	12

479 VERSAGRIP® Stainless steel tong Pinza VERSAGRIP® de acero inoxidable Pince inox VERSAGRIP®

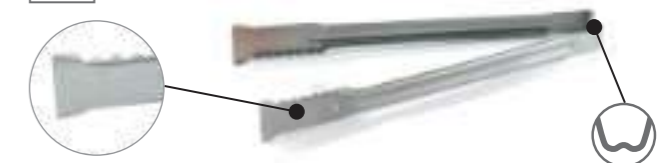

REF	L cm	
4791210	30,5	12
4791610	40,6	12

P968 Carry-skewers Porta pinchos Porte-brochettes



REF	Ø cm	H cm	
P968000	22	46	1

P9681 Skewer Pincho Brochette

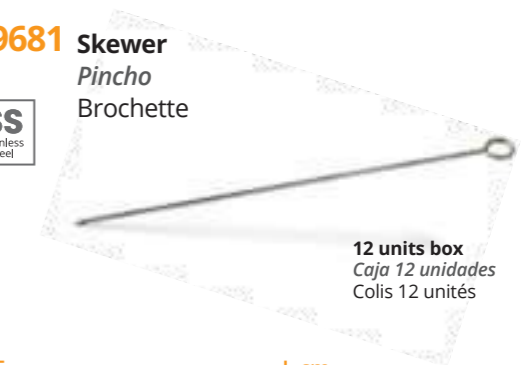

12 units box
Caja 12 unidades
Colis 12 unités

REF	L cm	
P968135	35	12

1.5 Grill cookware

Menaje brasa
Matériel à braise

See products on
Ver productos en / Voir produits en page

P. 60

Black Series



Grill cookware 1.5

Menaje brasa
Matériel à braise

See products on
Ver productos en / Voir produits en page

P. 460

Cast iron miniatures Miniaturas hierro fundido Miniatures fonte émaillée



See products on
Ver productos en / Voir produits en page

P. 78

Black Pro



See products on
Ver productos en / Voir produits en page

P. 88

Roast pan Rustidera Plaque à rôtir



See products on
Ver productos en / Voir produits en page

P. 465

Tin plates display Llaunas presentación Plateaux inox présentation



See products on
Ver productos en / Voir produits en page

P. 81

Steel Pro 1921 Series



See products on
Ver productos en / Voir produits en page

P. 83

Steel Classic



See products on
Ver productos en / Voir produits en page

P. 84

Spanish paella pan & Deep enamelled fry pan Paellera y Sartén Honda Plat à paella et poêle haute



2 Cookware

Batería de Cocina
Batterie de Cuisine



2.1		TRIBUTE	42
2.2		INOX-PRO	46
2.3		IDEA	53
2.4		COOL-LINE	54
2.5		CENTURY	56
2.6		BLACK SERIES	60
2.7		BLACK FORGED	61













Which cookware do you need?

¿Qué batería necesitas?
Quel batterie de cuisine vous faut-il ?

Stainless Steel Acero Inoxidable Acier Inox

Stainless Steel
Acero Inoxidable
Acier Inox

Aluminium Aluminio Aluminium

	TRIBUTE	INOX-PRO	IDEA	COOL • LINE	CENTURY	BLACK SERIES	BLACK FORGED
							
	P. 42	P. 46	P. 53	P. 54	P. 56	P. 60	P. 61
COMPATIBLE WITH COMPATIBLE CON COMPATIBLE AVEC	 INDUCTION	 INDUCTION	 INDUCTION	 INDUCTION	 NO INDUCTION	 NO INDUCTION	 INDUCTION
							
PRICE PRECIO PRIX							
WARRANTY YEARS GARANTÍA AÑOS GARANTIE ANNÉES	1,5	5	3	4	1	2	2
CERTIFICATION CERTIFICACIÓN CERTIFICATION							
HANDLES ASAS ANSES	WIRE VARILLA FILS	WIRE VARILLA FILS	DESIGN DISEÑO DESIGN	CAST FUNDICIÓN FONTE	TUBULAR TUBULAR TUBULAIRE	INTEGRATED INTEGRADO INTÉGRÉ	INTEGRATED INTEGRADO INTÉGRÉ
RESTAURANT RESTAURANTE RESTAURANT	ANY KIND TODO TIPO TOUS TYPOS	ANY KIND TODO TIPO TOUS TYPOS	MODERN MODERNA MODERNE	GOURMET	TRADITIONAL TRADICIONAL TRADITIONNEL	TRADITIONAL AND PRESENTATION TRADICIONAL Y PRESENTACIÓN TRADITIONNEL ET PRESENTATION	TRADITIONAL TRADICIONAL TRADITIONNEL
MEASURES Ø MEDIDAS Ø MESURES Ø	12-35	12-60	12-32	14-32	16-60	16-40	16-28

2.1 TRIBUTE

Mp
Multiply

NEW!

Stainless steel cover with a welded all-natural antimicrobial dipped handle.

Tapa de acero inoxidable con asa antimicrobial natural completamente soldada.

Couvercle en acier inoxydable avec poignée antimicrobienne naturelle complètement soudée.

Handle design offers a comfortable, ergonomic grip and minimizes heat transfer. Silicone TriVent handle withstands temperatures up to 450°F.

El diseño del mango ofrece un agarre cómodo y ergonómico y minimiza la transferencia de calor. El mango TriVent de silicona soporta temperaturas de hasta 232 °C.

La conception du manche offre une prise en main confortable et ergonomique et minimise le transfert de chaleur. Le manche TriVent en silicone résiste à des températures allant jusqu'à 232 °C.

Welded handles ensure a secure connection. Ever-Tite riveting system promises a lifetime limited warranty against loose rivets.

Los puntos de soldadura de las asas garantizan una sujeción segura. El sistema de remachado Ever-Tite ofrece una garantía de por vida.

Les points de soudure des poignées assurent une prise en main sûre. Le système de rivetage Ever-Tite offre une garantie à vie.

3-ply construction is durable and maintains shape. 3004-Series aluminum core for even heating across the bottom and walls.

Composición Tri Capa que alarga la vida útil en la forma y aplicación del producto. El núcleo en aluminio de la serie 3004 permite una transmisión uniforme del calor en la parte interior y paredes de la batería.

Composition triple couche qui prolonge la durée de vie utile dans la forme et l'application du produit. Le centre en aluminium de la série 3004 permet une transmission uniforme de la chaleur à l'intérieur et sur les parois de la batterie.

18-0 grade stainless steel exterior is induction-ready.

La aleación de acero inoxidable 18/0 aporta al producto un uso apto para inducción.

Grâce à l'alliage d'acier inoxydable 18/0 le produit est adapté à l'induction.



Tribute^{by} VOLLRATH

3-ply cookwarebody
Cuerpo tricapa
Corps triple couche



Stainless steel 18/8
Inox 18/8

Aluminium 3004
Aluminio 3004

Stainless steel 18/0
Inox 18/0

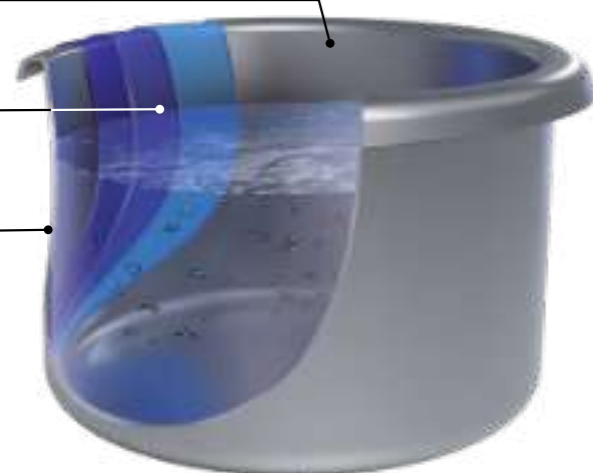

Others



Multimetal

The professional Tribute® Kitchenware set is Vollrath's the high-end option.

It's 3-ply design, from base to sides, is composed of three high-quality materials:

- Interior coating, over the entire cooking surface, in 18/8 stainless steel, which is color and flavor neutral.
- A 3004 aluminum core which guarantees a perfectly uniform heat distribution.
- An easy-to-clean and durable 18/0 stainless steel exterior.

La batería profesional Tribute® es la elección de alta gama de Vollrath, especialmente diseñada para el alto rendimiento en cocina.

Su cuerpo tri-capa, desde la base hasta los laterales, está compuesto por tres materiales de alta calidad:

- Un revestimiento interior, por toda la superficie de cocción, de acero inoxidable 18/8 que mantiene intactos los sabores y colores de los alimentos.
- Un centro de aluminio 3004 que garantiza una distribución perfectamente uniforme del calor.
- Un exterior de acero inoxidable 18/0 de fácil limpieza y alta resistencia.

La batterie professionnelle Tribute® est le choix haut de gamme de Vollrath, spécialement conçue pour la haute performance en cuisine.

Son corps triple couche, sur la base et les latéraux, est composé de trois matériaux haut de gamme :

- Un revêtement intérieur, sur toute la surface de cuisson, en acier inoxydable 18/8 qui garde intacts les saveurs et les couleurs des aliments.
- Un centre en aluminium 3004 garantit une distribution parfaitement uniforme de la chaleur.
- Un extérieur en acier inoxydable 18/0 facile à nettoyer et très résistant.



Vollrath is dedicated to keeping your operation running smoothly, which is why we offer a lifetime warranty on so many of our products.

Note:
Jacob's Pride® warranty does not cover plastisol coating on handle.

Vollrath se dedica a mantener su operación funcionando sin problemas, razón por la cual ofrecemos una garantía de por vida en muchos de nuestros productos.

Nota:
El certificado de garantía Jacob's Pride® no cubre el revestimiento de plastisol en el mango.

Vollrath se consacre à assurer le bon fonctionnement de votre activité, raison pour laquelle nous offrons une garantie à vie sur plusieurs de nos produits.

Note:
La garantie Jacob's Pride® ne couvre pas le revêtement en plastisol sur la poignée.



Tribute 2.1

775 Stock pot
Olla recta
Marmite traiteur



REF	Ø cm	H cm	Lts	☐
77519	22	14,6	5,6	1
77520	24	15,2	7,5	1
77521	30	15,9	11,4	1
77522	30	21,6	15,1	1
77523	35	19,7	18,9	1

7776 Sauce Pot
Cacerola alta
Braisière



REF	Ø cm	H cm	Lts	☐
77760	12	13,7	9,4	1
77761	14	14,2	14,1	1

702111 Rounded saucepan
Cazo bombeado
Casserole bombée



REF	Ø cm	H cm	Lts	☐
702111	28	8,9	4,5	1

7021 Sauce Pan
Cazo recto
Casserole



REF	Ø cm	H cm	Lts	☐
702115	16	7,6	1,4	1
702125	18	8,9	2,4	1
702135	20	10,5	3,3	1
702145	22	10,5	3,3	1

693 Lid
Tapa
Couvercle



REF	Ø cm	☐
69325	16	1
69328	20	1
69329	22	1
69410	24	1
69412	30	1
69414	35	1

See products on
Ver productos en / Voir produits en page

P. 69

Tribute fry pan
Sartén Tribute
Poêl Tribute



2.2 INOX-PRO



Cookware body made of 18/10 stainless steel
Cuerpo en acero inoxidable 18/10
 Corps en acier inoxydable 18/10

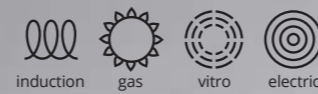

Specially designed to achieve the best performance in the professional cooking
Diseñada para ofrecer el mayor rendimiento en la cocina profesional
 Conçue pour offrir le plus haut rendement dans la cuisine professionnelle



Efficacy
Eficacia
 Efficacité



Control: handcrafted welding and checking every unit
Control: soldadura artesanal e inspección en cada unidad
 Contrôle : soudure artisanale et vérification de chaque unité

Solid and robust: st/steel wire handle ultra-resistant, 500kg.



Sólida y robusta: asas de varillas matizada en inox ultraresistentes, 500 kg.

Solide et robuste : anses en fil inox ultra-résistantes, 500kg.

Warranty: control of all production processes
Garantía: control de todos los procesos de fabricación
 Garantie : contrôle de tous les processus de production

Quality: inner and outer sides of all models with uniform satin polishing

Calidad: pulido satinado interior y exterior uniforme en todos los modelos

Qualité : polissage satiné uniforme à l'intérieur et l'extérieur de tous les modèles

Radius specially designed for easy and fast cleaning
Radios interiores diseñados para una limpieza fácil y rápida
 Rayons permettant un entretien facile et rapide

Safety : welded handles by build-up process
Segura: asas soldadas por aportación de materiales
 Sécurité : soudures des anses par résistance

Unique: origin identification and type of cooking system
Única: identificación de origen y tipo fuente de calor
 Unique : identification de l'origine et type de système de cuisson

Efficient: lids designed to save energy
Eficiente: tapas diseñadas para el ahorro de energía
 Éfficient : couvercles conçus pour économiser de l'énergie

Induction: technical sandwich base (stainless steel - aluminium - stainless steel)

Inducción: fondo sandwich técnico (inox - alu - inox)

Induction : fond sandwich technique (inox - alu - inox)



Cookware is sold without lids.
Las baterías de cocina se venden sin tapa.
 Les batteries de cuisine sont-elles vendues sans couvercle.

2.2 Inox-Pro



P218 Stock pot without lid
Olla recta sin tapa
Marmite traiteur sans couvercle



REF	Ø cm	H cm	Lts	
P218016	16	16,0	3,0	1
P218018	18	18,0	4,5	1
P218020	20	20,0	6,2	1
P218024	24	24,0	10,0	1
P218028	28	28,0	16,5	1
P218030	30	30,0	21,2	1
P218032	32	32,0	24,0	1
P218035	35	35,0	33,6	1
P218040	40	40,0	50,0	1
P218045	45	45,0	72,0	1
P218050	50	50,0	98,0	1
P218060	60	55,0	155,0	1

P217 Casserole without lid
Cacerola baja sin tapa
Faitout sans couvercle



REF	Ø cm	H cm	Lts	
P217016	16	7,5	1,5	1
P217018	18	8,0	2,0	1
P217020	20	8,0	2,5	1
P217024	24	9,50	4,3	1
P217028	28	11,0	6,7	1
P217030	30	12,0	8,4	1
P217032	32	12,5	10,0	1
P217035	35	14,0	13,6	1
P217040	40	15,5	19,5	1
P217045	45	17,0	27,0	1
P217050	50	20,0	39,0	1
P217060	60	23,0	65,0	1

P216 Sauce pot without lid
Cacerola alta sin tapa
Braising sans couvercle



REF	Ø cm	H cm	Lts	
P216016	16	11,0	2,1	1
P216018	18	12,0	3,0	1
P216020	20	13,0	4,0	1
P216024	24	14,0	6,3	1
P216028	28	17,5	10,2	1
P216030	30	18,0	12,7	1
P216032	32	19,0	15,2	1
P216035	35	21,0	20,2	1
P216040	40	25,0	31,4	1
P216045	45	28,0	44,5	1
P216050	50	30,0	59,0	1
P216060	60	35,0	99,0	1

P205 Paella pan without lid
Paellera sin tapa
Plat à paella sans couvercle



REF	Ø cm	H cm	Lts	
P205020	20	6,0	1,9	1
P205024	24	6,0	2,7	1
P205028	28	6,0	3,7	1
P205030	30	6,0	4,3	1
P205032	32	6,0	4,7	1
P205035	35	7,0	6,7	1
P205040	40	8,0	10,0	1
P205045	45	8,5	12,0	1
P205050	50	9,0	17,5	1
P205060	60	10,0	28,0	1

Inox-Pro 2.2



P209 Lid
Tapa
Couvercle



REF	Ø cm	
P209016	16	1
P209018	18	1
P209020	20	1
P209024	24	1
P209028	28	1
P209030	30	1
P209032	32	1
P209035	35	1
P209040	40	1
P209045	45	1
P209050	50	1
P209060	60	1

P202 Deep saucepan
Cazo recto alto
Casserole haute



REF	Ø cm	H cm	Lts	
P202016	16	11,0	2,1	1
P202018	18	12,0	3,0	1
P202020	20	13,0	4,0	1
P202024	24	14,0	6,3	1
P202028	28	17,5	10,2	1
P202032	32*	19,0	15,2	1

* With counterhandle / Con contraasa / Avec contre anse

P2001 Saucepan with side spouts
Cazo con picos laterales
Casserole avec becs verseurs



REF	Ø cm	H cm	Lts	
P200116	16	7,5	1,5	1
P200120	20	10,0	3,1	1

P201 Saucepan
Cazo recto bajo
Casserole



REF	Ø cm	H cm	Lts	
P201016	16	7,5	1,5	1
P201018	18	8,0	2,0	1
P201020	20	8,0	2,5	1
P201024	24	9,5	4,3	1
P201028	28	11,0	6,7	1
P201032	32*	12,50	10,0	1

* With counterhandle / Con contraasa / Avec contre anse

P200 French style saucepan
Cazo tipo francés
Casserole forme française



REF	Ø cm	H cm	Lts	
P200012	12	7,0	0,7	1
P200014	14	7,0	1,0	1
P200016	16	7,5	1,5	1
P200018	18	9,0	2,3	1
P200020	20	10,0	3,1	1
P200022	22	11,0	4,2	1
P200024	24	12,0	5,4	1
P200028	28	14,0	8,6	1

P214 Conical sauté pan
Cazo cónico
Sauteuse evasée



REF	Ø cm	H cm	Lts	
P214016	16	6,0	1,0	1
P214018	18	6,0	1,2	1
P214020	20	6,5	1,6	1
P214022	22	7,0	2,1	1
P214024	24	7,5	2,7	1

2.2 Inox-Pro



P2003 Rounded saucepan
Cazo bombeado
Casserole bombée



With diffusing bottom sandwich type
Con fondo termodifusor tipo sandwich
Avec fond thermo diffuseur type sandwich

REF	Ø cm	H cm	Lts	
P200320	20	7,5	1,8	1
P200324	24	8,5	3,0	1

P203 Bain marie
Baño maría
Bain-marie



With diffusing bottom sandwich type
Con fondo termodifusor tipo sandwich
Avec fond thermo diffuseur type sandwich

REF	Ø cm	H cm	Lts	
P203016	16	16,0	3,0	1
P203018	18	18,0	4,5	1
P203020	20	20,0	6,2	1
P203024	24	24,0	10,0	1

P204 Sauté pan
Sautex
Sauteuse



REF	Ø cm	H cm	Lts	
P204020	20	6,0	1,9	1
P204024	24	6,0	2,7	1
P204028	28	6,0	3,7	1
P204030	30	6,0	4,3	1
P204032	32	6,0	4,7	1
P204035	35	7,0	6,7	1
P204040*	40	8,0	10,0	1

* With counterhandle / Con contraasa / Avec contre anse

Multimetal

Stainless steel 18/8
Inox 18/8

Aluminium 3004
Aluminio 3004

Stainless steel 18/0
Inox 18/0



st/steel - Inox



Multimetal

P234 Rounded saucepan
Cazo bombeado
Casserole bombée



REF	Ø cm	H cm	Lts	
P234020	20	7,5	1,8	1
P234024	24	8,5	3,0	1

Inox-Pro 2.2



P240 Conical couscous set with lid
Conjunto cuscusera bombeada, con tapa
Couscoussier bombée avec couvercle



REF	Ø cm	H cm	Lts		
P240040	A	40	20,0	20,0	1
	B	32	32,0	24,0	
P240050	A	50	25,0	40,0	1
	B	40	40,0	50,0	

P242 Straight couscous set
Conjunto cuscusera forma recta
Couscoussier forme droite



REF	Ø cm	H cm	Lts		
P242024	A	24	14,0	6,3	1
	B	24	24,0	10,0	
P242028	A	28	17,5	10,0	1
	B	28	28,0	16,5	
P242032	A	32	19,0	15,0	1
	B	32	32,0	24,0	
P242035	A	35	21,0	20,0	1
	B	35	35,0	33,6	

With lid / Con tapa / Avec couvercle

P241 Top for couscous set conical shape
Parte superior de cuscusera bombeada
Dessus seul pour couscoussier forme bombée



REF	Ø cm	H cm	Lts	
P241040	40	20,0	20,0	1
P241050	50	25,0	40,0	1

Ø holes / agujeros / trous 4 mm
Without lid / Sin tapa / Sans couvercle

P243 Top for steam pot and couscous set straight shape
Parte superior de vaporera y cuscusera
Dessus seul pour couscoussier forme droite et cuit vapeur



REF	Ø cm	H cm	Lts	
P243024	24	14,0	6,3	1
P243028	28	17,5	10,0	1
P243032	32	19,0	15,0	1
P243035	35	21,0	20,0	1

Ø holes / agujeros / trous 4 mm
Without lid / Sin tapa / Sans couvercle

2.2 Inox-Pro



P244 Steam pot Conjunto vaporera Cuit vapeur



REF	Ø cm	H cm	Lts	
P244024	A 24	14,0	6,3	1
	B 24	14,0	6,3	
P244028	A 28	17,5	10,0	1
	B 28	17,5	10,0	
P244032	A 32	19,0	15,0	1
	B 32	19,0	15,0	
P244035	A 35	21,0	20,0	1
	B 35	21,0	20,0	

With lid / Con tapa / Avec couvercle

P224 Pasta colander Colapasta Cuit-pâtes



REF	H cm	
P224023	A 23,0	12
P224026	B 26,0	6

A It fits ref. 216 - Ø 35 cm
A Utilizable para la ref. 216 - Ø 35 cm
A Utilisable pour la ref. 216 - Ø 35 cm

B It fits ref. 216 - Ø 40 cm
B Utilizable para la ref. 216 - Ø 40 cm
B Utilisable pour la ref. 216 - Ø 40 cm

P223 Casserole set + 4 pasta colander Conjunto cacerola + 4 colapastas Ensemble braisière + 4 cuit-pâtes



REF	Ø cm	H cm	Lts	
P223035	35	21,0	20,2	1
P223040	40	25,0	31,4	1

Casserole data 216.
Datos relativos a la cacerola 216.
Caractéristiques afférentes au braisière 216.

Without lid / Sin tapa / Sans couvercle

P248 Stock pot with tap and lid Olla con grifo y tapa Marmite traiteur avec robinet et couvercle



REF	Ø cm	H cm	Lts	
P248028	28	28,0	16,5	1
P248032	32	32,0	24,0	1
P248035	35	35,0	33,6	1
P248040	40	40,0	50,0	1
P248045	45	45,0	72,0	1

2.3 IDEA



St/steel
Inox

Aluminium
Aluminio

Magnetic st/steel
Inox magnético
Inox magnétique



ALL OVER TECHNOLOGY

Encapsulated sandwich base without empty cavities, for a faster and more uniform heat diffusion

Fondo difusor encapsulado, sin dejar cavidades vacías para una difusión del calor rápida y uniforme

Fond thermodifusé encapsulé, sans laisser de cavités vides et permettant une diffusion de la chaleur plus rapide et uniforme

P458 Stock pot with lid Olla con tapa Marmite traiteur avec couvercle



REF	Ø cm	H cm	Lts	
P458024	24	20,0	9,00	1
P458028	28	24,0	14,50	1

P456 Sauce pot with lid Cacerola alta con tapa Braisière avec couvercle



REF	Ø cm	H cm	Lts	
P456016	16	11,0	2,20	1
P456020	20	13,0	4,10	1
P456024	24	14,0	6,30	1
P456028	28	16,0	9,80	1

P457 Casserole with lid Cacerola baja con tapa Faitout avec couvercle



REF	Ø cm	H cm	Lts	
P457016	16	7,5	1,50	1
P457020	20	8,0	2,50	1
P457024	24	9,5	4,30	1
P457028	28	11,0	6,70	1

P454 Saucepan Cazo recto Casserole



REF	Ø cm	H cm	Lts	
P454012	12	7,0	0,70	1
P454014	14	7,0	1,00	1
P454016	16	7,5	1,50	1
P454018	18	9,0	2,30	1

2.4 COOL-LINE

EXCLUSIVE

Cookware body made of 18/10 stainless steel
Cuerpo en acero inoxidable 18/10
Corps en acier inoxydable 18/10



Special lid designed to hold on the side handle
Tapa con diseño especial para apoyo en asa lateral
Couvercle spécial, conçu pour reposer sur la poignée

Ergonomic handles made of cast st/steel
Asas ergonómicas fabricadas en acero inoxidable de fundición
Anses en fonte d'acier inoxydable, ergonomiques

Tech sandwich base
Fondo termo difusor técnico
Fond thermo-diffuseur technique



SS
Stainless
steel

Cool-line 2.4



Ref. colour
Ref. color
Ref. couleur couvercle



P4906CO Sauce pot with lid
Cacerola alta con tapa
Braising pot with cover



REF	Ø cm	H cm	Lts	☐
P490620 + COLOR	20	13,0	3,7	1
P490624 + COLOR	24	14,0	5,8	1
P490628 + COLOR	28	17,5	9,5	1
P490632 + COLOR	32	19,0	14,0	1

P4907CO Casserole with lid
Cacerola baja con tapa
Faitout with cover



REF	Ø cm	H cm	Lts	☐
P490724 + COLOR	24	9,5	3,9	1
P490728 + COLOR	28	11,0	5,8	1
P490732 + COLOR	32	12,5	8,9	1

P4909 Paella pan with lid
Paellera con tapa
Plat à paella avec couvercle



REF	Ø cm	H cm	Lts	☐
P490928 + COLOR	28	6,0	3,7	1
P490932 + COLOR	32	6,0	4,7	1

P4900CO Saucepan
Cazo recto
Casserole



REF	Ø cm	H cm	Lts	☐
P490014 + COLOR	14	7,0	1,0	1
P490016 + COLOR	16	7,5	1,5	1

2.5 CENTURY

Pure extra strength aluminium cookware
Batería de aluminio puro extra fuerte
 Batterie de cuisine en aluminium pur extra fort



Made of 100% recyclable pure aluminum sheets of up to 5 mm (depending on diameter).

Fabricadas en chapas de aluminio de hasta 5 mm (según diámetro) de puro aluminio 100% reciclable.

Faites de tôles d'aluminium à 100 % recyclable, jusqu'à 5 mm d'épaisseur (selon le diamètre).

Reinforced rims
Bordes reforzados
 Bords renforcés

Ergonomic handles
Asas ergonómicas
 Anses ergonomiques

Highly resistant and safe riveting
Remache de alta resistencia y seguridad
 Rivet à haute résistance et sécurité

Extra-thick walls
Paredes de mayor grosor
 Parois plus épaisses

Polished exterior preventing the growth of bacteria
Exterior pulido evita alojamiento de bacterias
 L'extérieur poli prévient l'accumulation de bactéries

Cookware is sold without lids.
Las baterías de cocina se venden sin tapa.
 Les batteries de cuisine sont-elles vendues sans couvercle.



Homogeneous cooking
Cocción homogénea
 Cuisson homogène

Excellent thermal conductivity
Excelente conductividad térmica
 Excellente conductivité thermique

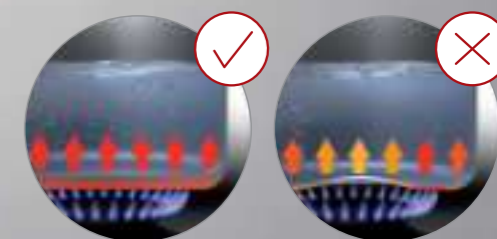

Base thickness that prevents deformation, in full contact with the heat source, thus improving energy efficiency.

Espesor del fondo que evita la deformación, en contacto total con la fuente de calor que permite un mayor rendimiento energético.

L'épaisseur du fond évite sa déformation, il est intégralement en contact avec la source de chaleur, ce qui permet un meilleur rendement énergétique.

P1183 Stock pot without lid
Olla sin tapa
Marmite traiteur sans couvercle

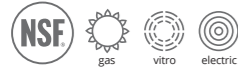

REF	Ø cm	H cm	Lts	
P118324	24	24,0	10,0	1
P118328	28	28,0	16,5	1
P118332	32	32,0	25,5	1
P118335	35	35,0	33,6	1
P118340	40	40,0	50,0	1
P118345	45	45,0	72,0	1
P118350	50	50,0	98,0	1
P118360	60	60,0	155,0	1

P1173 Casserole without lid
Cacerola baja sin tapa
Faitout sans couvercle

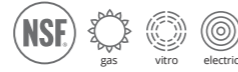

REF	Ø cm	H cm	Lts	
P117324	24	9,5	4,3	1
P117328	28	11,0	6,7	1
P117332	32	12,5	10,0	1
P117335	35	14,0	13,0	1
P117340	40	16,0	20,0	1
P117345	45	18,0	28,0	1
P117350	50	21,0	41,0	1
P117360	60	25,0	70,0	1

P1163 Sauce pot without lid
Cacerola alta sin tapa
Braisière sans couvercle

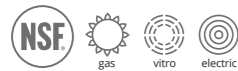

REF	Ø cm	H cm	Lts	
P116324	24	14,0	6,3	1
P116328	28	17,5	10,2	1
P116332	32	19,0	15,2	1
P116335	35	21,0	20,2	1
P116340	40	25,0	31,4	1
P116345	45	28,0	44,5	1
P116350	50	31,0	60,8	1
P116360	60	37,0	104,6	1

P1153 Paella pan without lid
Paellera sin tapa
Plat à paella sans couvercle

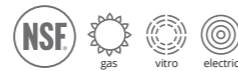

REF	Ø cm	H cm	Lts	
P115320	20	5,5	1,75	1
P115324	24	6,0	2,75	1
P115340	40	8,0	10,00	1

P1123 Lid
Tapa
Couvercle



REF	Ø cm	
P112324	24	1
P112328	28	1
P112332	32	1
P112335	35	1
P112340	40	1
P112345	45	1
P112350	50	1
P112360	60	1

P1043 Saucepan
Cazo recto
Casserole



REF	Ø cm	H cm	Lts	
P104318	18	9	2	1
P104320	20	10	3	1
P104324	24	12	5	1

P1063 Sauté pan
Sautex
Sauteuse

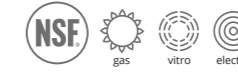

REF	Ø cm	H cm	Lts	
P106320	20	5,5	1,75	1
P106324	24	6,0	2,75	1

P1033 Rounded saucepan
Cazo bombeado
Casserole bombée



REF	Ø cm	H cm	Lts	
P103322	22	11	3	1

See products on
Ver productos en / Voir produits en page

P. 74

Aluminium non-stick fry pan
Sartén aluminio antiatherente
Poêle anti-adhésive



2.6 BLACK SERIES



Manufactured from cast aluminium offering high deformation resistance and excellent thermal properties

Fabricada en aluminio de fundición de gran resistencia a la deformación y con excelentes prestaciones térmicas

Fabriquée en fonte d'aluminium très résistante à la déformation et dotée d'excellentes performances techniques

Exterior: black, high temperature resistant paint

Exterior: pintura negra resistente a altas temperaturas

Extérieur : peinture noire résistante aux températures élevées

Highly resistant non-stick surface

Antiadherente de alta resistencia

Antiadhésif très résistant



P141 Shallow casserole without lid

Cazuela baja sin tapa
Cocotte sans couvercle



Ground base
Fondo torneado
Fond dressé

REF	Ø cm	H cm	Lts	☐
P141014*	14	4,0	0,55	1
P141016*	16	5,0	0,90	1
P141020*	20	5,5	1,50	20
P141024	24	5,8	2,25	10
P141028	28	7,5	4,00	1
P141032	32	8,0	5,75	1
P141036	36	8,5	7,75	5
P141040	40	10,0	11,25	4

P161 Paella pan without lid

Paella sin tapa
Plat à paella sans couvercle



REF	Ø cm	H cm	☐
P161034	34	4	1
P161038	38	4	1

Ideal for ovens, grills and barbecues
Ideal para hornos, brasa y barbacoa
Idéal pour fours, grill et barbecue

P151 Deep casserole without lid

Cazuela alta sin tapa
Braising sans couvercle



Ground base
Fondo torneado
Fond dressé

REF	Ø cm	H cm	Lts	☐
P151012*	12	8,5	0,85	12
P151014*	14	8,5	1,10	1
P151016*	16	8,0	1,40	12
P151020	20	9,0	2,50	12
P151024	24	10,0	4,00	6
P151028	28	12,0	6,65	6
P151032	32	14,0	10,00	3

See products on

Ver productos en / Voir produits en page

P. 399



*MINI-SIZE

Ideal for food presentation.
Ideal para presentación.
Idéal pour présentation.

2.7 BLACK FORGED



Forged aluminium with a non-stick interior surface and with high temperature resistant paint on the outside

Aluminio forjado con antiadherente en su interior, y pintura resistente a altas temperaturas en el exterior

Aluminium avec revêtement antiadhésif à l'intérieur, et peinture résistante aux températures élevées à l'extérieur

Full heat-diffusing base which offers excellent performance on induction hobs.

Fondo difusor completo que permite un excelente rendimiento en cocinas de inducción.

Fond diffuseur complet offrant une haute performance sur les cuisinières a induction.

Ferritic stainless steel sheet that covers the whole of the base.

Chapa de acero inoxidable ferrítico que cubre la totalidad del fondo.
Plaque en acier inoxydable ferritique qui couvre tout le fond.



Glass lid
Tapa de cristal
Couvercle en verre

P170 Saucepot with lid

Cacerola alta con tapa
Braising avec couvercle



Silicone handles included
Asas de silicona incluidas
Anses en silicone incluses



REF	Ø cm	H cm	Lts	☐
P170020	20	8,5	2,5	2
P170024	24	9,0	4,0	2
P170028	28	12,5	7,5	2

P171 Casserole with lid

Cacerola baja con tapa
Faitout avec couvercle



Silicone handles included
Asas de silicona incluidas
Anses en silicone incluses



REF	Ø cm	H cm	Lts	☐
P171024	24	7,5	3,0	2
P171028	28	7,5	4,5	2

P173 Saucepan

Cazo
Casserole



REF	Ø cm	H cm	Lts	☐
P173016	16	8,4	1,5	2

See products on

Ver productos en / Voir produits en page

P. 80



Black forged fry pan
Sartén black forged
Poêle black forged

Bakelite handle / Mango baquelita / Queue en bakélite

3 Fry pans

Sartenes
Poêles



3.1  **WEAR EVER** NEW! 68
ALUMINIUM / ALUMINIO / ALUMINIUM

3.2  **TRIBUTE** NEW! 69
MULTI-PLY / MULTIMETAL / MULTI-METAL

3.3  **ST/STEEL** 70
ACERO INOXIDABLE / ACIER INOXYDABLE

INOX PRO 70
INOX FIRST 72
ALU FIRST 76

3.4  **ALUMINIUM** 73
ALUMINIO / ALUMINIUM

ALU PRO INDUCTION 74
ALU PRO NO INDUCTION 74
ALU FIRST 76

3.5  **MULTI-PLY** 77
MULTIMETAL / MULTI-METAL

3.6  **CAST ALUMINIUM** 76
ALUMINIO FUNDICIÓN / FONTE D'ALUMINIUM

BLACK PRO 78
BLACK FORGED 80
BLACK FIRST 80

3.7  **STEEL** 81
ACERO / ACIER

STEEL PRO 81
STEEL EXPERT 82

3.8  **SPANISH PAELLA PAN** 84
PAELLERA / PLAT À PAELLA

Which material should I choose?

¿Qué material debo elegir?
Quel matériau choisir ?

	MULTI-PLY	STAINLESS STEEL	ALUMINIUM	CAST ALUMINIUM	CARBON STEEL
	MULTIMETAL MULTIMÉTAL	ACERO INOX ACIER INOX	ALUMINIO ALUMINIUM	ALUMINIO FUNDICION ALUMINIUM DE FONTE	ACERO AL CARBONO ACIER AU CARBONE
	Mp Multiply	SS Stainless steel	Al Aluminium	CA Cast Aluminum	CS Carbon steel
MATERIAL MATERIAL MATÉRIAU	Solid and impact resistant. <i>Sólido y resistente a impactos.</i> Solide et résistant aux impacts.	High resistance to impact, maintaining a perfect physical state. <i>Alta resistencia a impactos, manteniendo un perfecto estado físico.</i> Haute résistance aux chocs, conserve un aspect physique parfait.	Extremely light and very malleable. Little resistance to impacts. <i>Extremadamente ligero y muy maleable. Poco resistente a los golpes.</i> Extrêmement léger et très malléable. Peu résistant aux coups.	High resistance to deformation. Temperatures up to 160°C. <i>Gran resistencia a la deformación. Temperaturas hasta 160°C.</i> Haute résistance à la déformation. Températures jusqu'à 160°C.	Very high weight. Highly vulnerable to corrosion (oxidization) <i>Peso muy elevado. Altamente vulnerable a la corrosión (oxidación).</i> Poids très élevé. Haute vulnérabilité à la corrosion (oxydation).
THERMAL CONDUCTIVITY CONDUCTIVIDAD TÉRMICA CONDUCTIVITÉ THERMIQUE	High thermal conductivity thanks to its inner layer of aluminium. <i>Conductividad térmica alta gracias a la capa interior de aluminio que posee.</i> Haute conductivité thermique grâce à la couche intérieure d'aluminium.	Perfect sealing of the thermodiffusing base. Efficient heat distribution. <i>Perfecta fijación del fondo difusor. Eficiente distribución del calor.</i> Parfaite fond thermodiffuseur. Distribution efficace de la chaleur.	Good conductivity and uniform heat distribution. Optimum material for energy saving. <i>Buena conductividad y distribución uniforme del calor. Óptimo material para ahorro de energía.</i> Bonne conductivité et distribution très uniforme. Matériau optimal pour l'économie d'énergie.	Excellent energy efficiency thanks to its induction base. <i>Excelente eficiencia energética gracias a la base de inducción que posee.</i> Efficacité énergétique excellente grâce à sa base à induction.	Very stable temperature for long cooking times. <i>Temperatura muy estable para cocinados de larga duración.</i> Haute conductivité thermique grâce à la couche intérieure d'aluminium.
USE USO UTILISER					
MAINTENANCE AND HYGIENE MANTENIMIENTO E HIGIENE ENTRETIEN ET HYGIÈNE	Cover with professional hygienic material (stainless steel). Dishwasher is not recommended. <i>Recubrimiento de material higiénico profesional (acero inoxidable). No se recomienda el uso de lavavajillas.</i> Revêtement en matériau hygiénique professionnel (acier inoxydable). L'utilisation du lave-vaisselle est déconseillée.	Non porous-material. Easy to clean. Not adherence for food residues. <i>Material no poroso. Fácil de limpiar. No adherencia de resto de alimentos.</i> Matériau non poreux. Facile à nettoyer. Difficile attacher du restes d'aliments.	Porous material. Very important to clean it properly to avoid contaminate food. <i>Material poroso. Limpieza correcta para evitar posible adherencia de bacterias.</i> Matériau poreux. Nettoyage correct pour éviter une éventuelle adhérence de bactéries.	Wash with hot water, neutral soap and non-abrasive sponge. Rinse plenty of water. <i>Lavar con agua caliente, jabón neutro y esponja no abrasiva. Enjuagar con abundante agua.</i> Laver avec de l'eau chaude, du savon neutre et une éponge non abrasive. Rincer abondamment à l'eau.	Before first use, it is advisable to use it to cook a disposable product. This allows the initial impurities to be cleaned from the pan. <i>Antes del primer uso, se aconseja cocinar algún producto desechable. Esto permitirá limpiar las impurezas iniciales del recipiente.</i> Avant la première utilisation, il est conseillé de faire cuire un produit jetable. Ce qui permettra de nettoyer les impuretés du récipient.

Handles

Mangos
Manches

ERGOS

MORE ERGONOMIC
MAYOR ERGONOMÍA
PLUS ERGONOMIQUE



Pujadas ERGOS handles are characterized by being made from stainless steel tubing. Thanks to a flattening process, the tubing becomes an ergonomic and heat insulating handle.

These handles are made with two holes at the two innermost end, to ensure that no water from the washing process remains inside and comes out in the form of steam when the pan is heated.

Los mangos ERGOS de Pujadas se caracterizan por estar fabricados en tubo de acero inoxidable. Gracias a un proceso de allanado, lo convierte en un mango ergonómico y aislante del calor. Estos mangos se presentan con dos agujeros en los dos extremos interiores, para asegurar que ninguna gota de agua quede dentro en el proceso de lavado y ésta salga en forma de vapor durante el calentamiento de la sartén.

Les manches ERGOS de Pujadas se caractérisent par leur fabrication à partir d'un tube en acier inoxydable. Le processus d'aplanissement obtient un manche ergonomique doté d'une isolation thermique.

Ces manches sont présentés avec deux trous aux deux extrémités intérieures, pour qu'aucune goutte d'eau ne reste à l'intérieur pendant le processus de lavage et que celle-ci sorte sous forme de vapeur lors du chauffage de la poêle.

HÉRCULES

GREATER STRENGTH
MAYOR SUJECIÓN
MEILLEURE PRISE



HÉRCULES handles are made of flat iron sheet coated with a high temperature resistant protective paint, which prevents rapid oxidation.

The handles have smoothed edges and a slight channel in the centre for increased strength.

Los mangos HÉRCULES son aquellos fabricados en chapa plana de hierro recubiertos con una pintura protectora resistente a altas temperaturas, que evita una rápida oxidación.

Esta chapa se presenta con los bordes pulidos y con una ligera canal en medio para una mejor sujeción.

Les manches HÉRCULES sont fabriqués en plaque de fer plate et recouverts d'une peinture protectrice résistante aux températures élevées, qui évite une oxydation rapide.

Cette plaque est dotée de bords polis et d'un léger canal au milieu pour une meilleure prise.

Which fry pan do you need?

¿Qué sartén necesitas?
Quelle poêle vous faut-il ?

FRY PANS
SARTÈNES
POÊLES

FRY PANS
SARTÈNES
POÊLES

Stainless Steel

Acero Inoxidable
Acier Inox

Aluminium

Aluminio
Aluminium

Cast aluminium

Aluminio fundición
Fonte d'aluminium

Steel

Acero
Acier

	TRIBUTE	INOX PRO	INOX FIRST	WEAR EVER	ALU PRO	ALU FIRST	BLACK PRO	BLACK FORGED	BLACK FIRST	STEEL PRO	STEEL EXPERT
											
	P. 69	P. 70	P. 72	P. 68	P. 73	P. 76	P. 78	P. 80	P. 80	P. 81	P. 83
COMPATIBLE WITH CON AVEC	INDUCTION 	INDUCTION 	INDUCTION 	NO INDUCTION 	INDUCTION 	INDUCTION 	INDUCTION 	INDUCTION 	NO INDUCTION 	INDUCTION 	INDUCTION 
PRICE PRECIO PRIX											
THICKNESS ESPESOR EPAISSEUR	4 mm	0,8 mm	0,7 mm	4 mm	4 mm	3,5mm	4 mm	3 mm	4 mm	2 mm	1,5 mm
COATING ANTIADHERENTE REVÊTEMENT	CERAMIGUARD® II			STEELCOAT X 3®							NINGUNO NONE AUCUN
HANDLE MANGO QUEUE	ST/STEEL INOXIDABLE INOXYDABLE	ST/STEEL INOXIDABLE INOXYDABLE	ST/STEEL INOXIDABLE INOXYDABLE	ST/STEEL INOXIDABLE INOXYDABLE	ST/STEEL INOXIDABLE INOXYDABLE	ST/STEEL INOXIDABLE INOXYDABLE	ST/STEEL INOXIDABLE INOXYDABLE	BAKELITE BAQUELITA BAKELIT (MAX. TEMP. 160 °C)	WOODEN MADERA BOIS	ST/STEEL INOXIDABLE INOXYDABLE	FLAT IRON HIERRO FER

3.1 WEAR EVER

NEW!

The Vollrath® Wear-Ever frying pan combines outstanding durability with dependable performance. Its impact-resistant aluminium construction heats and cools quickly, with a low-profile design that cleans just as easily. Our advanced SteelCoat x3® takes non-stick to the next level, providing better release, faster cleaning and longer life. The new handle provides a cooler, more comfortable ergonomic grip.

La sartén Wear-Ever de Vollrath® combina una durabilidad excepcional con una fiabilidad única. Fabricada en aluminio resistente a los impactos, se calienta y enfría rápidamente y su diseño extra plano se limpia fácilmente. Nuestro avanzado recubrimiento SteelCoatx3® eleva el antiadherente al siguiente nivel ofreciendo una mayor capacidad para resbalar a los alimentos, una limpieza más rápida y una vida útil superior. El nuevo mango, de tacto frío, ofrece un agarre ergonómico más confortable.

La poêle Vollrath® Wear-Ever combine durabilité exceptionnelle et performances fiables. Fabriquée en aluminium résistant aux chocs, elle chauffe et refroidit rapidement, sa conception extraplate se nettoie tout aussi facilement. Notre revêtement SteelCoat x3® avancé fait passer l'antiadhésif au niveau supérieur, offrant un meilleur démoulage, un nettoyage plus rapide et une durée de vie plus longue. Le nouveau manche offre un toucher froid et une prise ergonomique plus confortable.



6713 Non-stick fry pan Sartén antiadherente Poêle anti-adhésive

REF	Ø cm	H cm	☐
671307	18	4	1
671308	20	4	1
671310	24	5	1
671312	28	5	1
671314	32	6	1

Also available with silicone handle.
También disponible con mango silicón.
Également disponible avec poignée en silicón.



Professional ergonomic handle resistant to high temperatures. Patented by Vollrath.

Mango ergonómico profesional resistente a altas temperaturas. Patentado por Vollrath.

Manche ergonomique professionnel résistant aux températures élevées. Breveté par Vollrath.

High-quality non-stick coating for longer life.

Antiadherente de gran calidad para una mayor vida útil.

Antiadhésif de haute qualité pour une durée de vie plus longue.

Heavy-duty, impact-resistant aluminum construction.

Fabricada con cuerpo de aluminio de alta calidad, resistente a impactos, para uso intensivo.

Fabriqué avec un corps en aluminium de haute qualité et résistant aux chocs pour une utilisation intensive.



NEW!

TRIBUTE 3.2

A versatile choice for high-end commercial kitchens, the extremely durable Tribute® frying pan's 3-ply construction delivers perfect heat distribution for impressive results. Frying, sautéing or searing, this induction-ready pan with premium CeramiGuard® II nonstick coating delivers exceptionally smooth release and easy cleaning. The new handle provides a cooler, more comfortable ergonomic grip, while the Ever-Tite system promises a limited lifetime warranty against loose rivets.

Una elección versátil de alta gama para las cocinas profesionales, la concepción tri-capa extremadamente duradera de la sartén Tribute® ofrece una distribución perfecta del calor para resultados impresionantes. Freír, saltar o sellar, esta sartén para inducción con recubrimiento antiadherente de alta gama CeramiGuard® II ofrece una liberación de los alimentos excepcionalmente suave y una limpieza fácil. El nuevo mango, de tacto frío, ofrece un agarre ergonómico más confortable mientras que el sistema Ever-Tite promete toda una vida de garantía contra los remaches sueltos.

Un choix polyvalent pour les cuisines professionnelles haut de gamme, la conception triple couches de la poêle Tribute® extrêmement durable offre une distribution parfaite de la chaleur pour des résultats impressionnants. Frire, sauter ou saisir, cette poêle à induction avec revêtement antiadhésif haut de gamme CeramiGuard® II offre un démoulage exceptionnellement souple et un nettoyage facile. Le nouveau manche offre un toucher froid et une prise ergonomique plus confortable, tandis que le système Ever-Tite promet une garantie limitée à vie contre les rivets desserrés.



6914 Non-stick fry pan Sartén antiadherente Poêle anti-adhésive

REF	Ø cm	H cm	☐
691407	18	4	1
691408	20	4	1
691410	24	5	1
691412	28	5	1
691414	32	6	1



Also available with silicone handle.
También disponible con mango silicón.
Également disponible avec poignée en silicón.

Professional ergonomic handle resistant to high temperatures. Patented by Vollrath.

Mango ergonómico profesional resistente a altas temperaturas. Patentado por Vollrath.

Manche ergonomique professionnel résistant aux températures élevées. Breveté par Vollrath.

Durable 3-ply construction provides exceptional heat distribution.

Cuerpo de multi-metal para una excepcional distribución del calor.
Corps multimétal pour une distribution exceptionnelle de la chaleur.

CeramiGuard® II nonstick coating
Antiadherente CeramiGuard® II
Anti-adhésif CeramiGuard® II



3.3 St/steel

Acero inoxidable
Acier inoxydable

SS
Stainless
steel

FRY PANS
SARTÈNS
POÈLES

INOX PRO

INDUCTION

FCA
FOOD CONTACT
APPROVED



BEST
SELLER

P220 Non-stick "ERGOS" excalibur fry pan
Sartén antiadherente excalibur "ERGOS"
Poêle anti-adhésive excalibur "ERGOS"



REF	Ø cm	H cm	
P220018	18	3,5	1
P220020	20	3,8	1
P220022	22	4,2	1
P220024	24	4,6	1
P220026	26	5,0	1
P220028	28	5,5	1
P220032	32	6,0	1
P220036	36	6,0	1
P220040	40	6,5	1

Non-stick coating
Antiadherente
Anti-adhésif

Sandwich bottom
Fondo sandwich
Fond sandwich

Probably the best frying pan in the world - maximum resistance to abrasion and long-lasting.

Probablemente la mejor sartén del mundo - máxima resistencia a la abrasión y de larga durabilidad.

Probablement la meilleure poêle du monde - résistance maximale à l'abrasion et longue durée de vie.

Non-stick coating treatment / Detalle tratamiento antiadherente / Détail application anti-adhésif



The surface of the substrate is blasted with an abrasive to roughen it, so other elements in the Excalibur process adhere to it better.

Para dar rugosidad a la superficie de la pieza se chorrea con elementos abrasivos y con ello se logra un buen anclaje del Excalibur.

Afin de la rendre rugueuse, la surface de la pièce est sablée avec un abrasif; ceci permettra une excellente tenue du procédé Excalibur.



Then, the most important part: White-hot particles of a special stainless steel (Whitford's patented alloy) are sprayed onto the roughened surface.

La parte más importante del proceso: la pulverización y deposición de las partículas fundidas de una aleación de acero inoxidable, patentada por Whitford.

Le processus plus important: des particules d'un acier inoxydable spécial (protégé par brevet par Whitford) sont chauffées à blanc et pulvérisées sur la pièce.



The particles cool and harden, bonded to the surface, forming a series of "peaks and valleys" that provide a permanent base for the non-stick coatings.

Las partículas se enfrían, formando parte integral de la superficie con "picos" y "valles" que permiten alojar las capas de antiadherente de forma permanente.

Ces particules se refroidissent, forment des crêtes et des vallées constituant une excellente base permanente d'accrochage et de renforcement de l'anti-adhésif.



Several coats of tough fluoropolymers fill the "valleys" and cover the "peaks", held permanently in place by the special stainless steel "peaks".

Finalmente se aplican varias capas de fluoropolímeros que rellenan los "valles" y cubren los "picos", que protegen el recubrimiento antiadherente.

Des couches d'anti-adhésif très résistantes sont appliquées; elles remplissent les vallées, recouvrent juste le haut des crêtes qui les maintiennent fermement en place.

St/steel 3.3

Acero inoxidable
Acier inoxydable

SS
Stainless
steel

FRY PANS
SARTÈNS
POÈLES

COOL-LINE

P4902CO Non-stick fry pan
Sartén antiadherente
Poêle anti-adhésive

INDUCTION
induction gas vitro electric

Non-stick coating
Antiadherente
Anti-adhésif



REF	Ø cm	H cm	
P490220 + COLOR	20	3,8	1
P490224 + COLOR	24	4,6	1
P490228 + COLOR	28	5,5	1

Sandwich bottom / Fondo sandwich / Fond sandwich

Ref. colour / Ref. color / Ref. couleur couvercle



See products on
Ver productos en / Voir produits en page **P. 54**



INOX CERAMIC

P2208 Fry pan with ceramic non-stick coating
Sartén antiadherente cerámico
Poêle revêtement anti-adhésif céramique

INDUCTION
induction gas vitro electric

Non-stick coating
Antiadherente
Anti-adhésif



REF	Ø cm	H cm	
P220820	20	3,8	1
P220824	24	4,6	1
P220828	28	5,5	1
P220832	32	6,0	1

INOX EXPERT

P213 Fry pan
Sartén
Poêle

INDUCTION
induction vitro gas electric oven CLASS INDUCTION



Sandwich bottom
Fondo sandwich
Fond sandwich

REF	Ø cm	H cm	
P213018	18	3,5	1
P213020	20	3,8	1
P213022	22	4,2	1
P213024	24	4,6	1
P213026	26	5,0	1
P213028	28	5,5	1
P213032	32	6,0	1
P213036	36	6,0	1
P213040	40	6,5	1

3.3 St/steel

Acero inoxidable
Acier inoxydable



INOX FIRST

P459 Fry pan
Sartén
Poêle

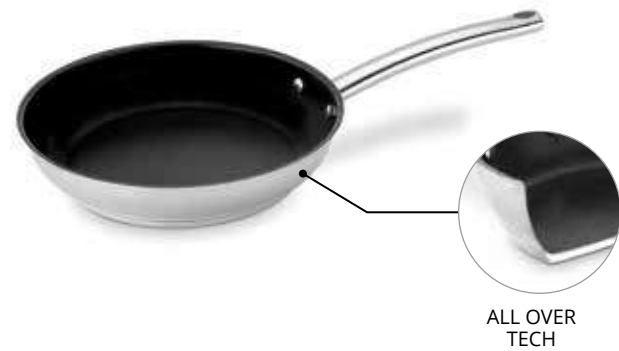

REF	Ø cm	H cm	Box
P459018	18	4,0	1 NEW
P459020	20	4,5	1
P459024	24	5,0	1
P459028	28	5,5	1
P459032	32	6,0	1 NEW

P2393 Round base wok
Wok fondo redondo
Wok à fond rond

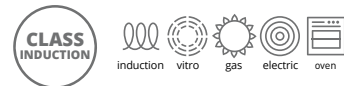

REF	Ø cm	H cm	Lts	Box
P239336	36	10,0	6,00	1

P2392 Flat base wok
Wok fondo plano
Wok à fond plain



REF	Ø cm	H cm	Lts	Box
P239236	36	9,0	5,50	1

See products on
Ver productos en / Voir produits en page

P. 291

Countertop induction wok
Placa de inducción wok 35 cm
Plaque wok induction 35 cm



Aluminum 3.4

Aluminio
Aluminium



3.4 Aluminum

Aluminio
Aluminium



ALU PRO

P1289 Non-stick induction fry pan "HERCULES"
Sartén antiadherente fondo inducción "HERCULES"
Poêle anti-adhésive fond induction "HERCULES"

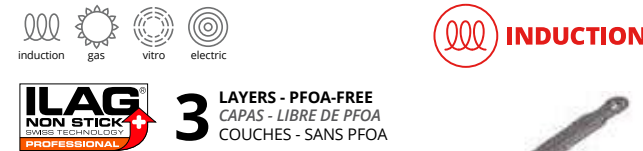

St/Steel sheet induction bottom
Fondo chapa inox. inducción
Fond plaque inox. induction

REF	Ø cm	H cm	Box
P128918	18	4,0	12 NEW
P128920	20	4,0	12
P128922	22	4,5	12 NEW
P128924	24	4,5	6
P128926	26	5,0	6 NEW
P128928	28	5,0	6
P128932	32	5,5	6
P128936	36	6,0	6 NEW

P1209 Non-stick induction fry pan "ERGOS"
Sartén antiadherente fondo inducción "ERGOS"
Poêle anti-adhésive fond induction "ERGOS"

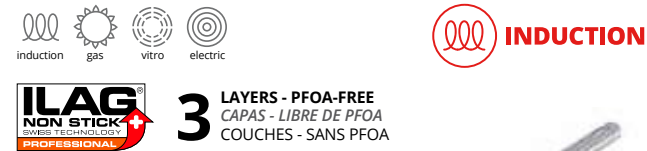

St/Steel sheet induction bottom
Fondo chapa inox. inducción
Fond plaque inox. induction

REF	Ø cm	H cm	Box
P120918	18	4,0	12 NEW
P120920	20	4,0	12
P120922	22	4,5	12 NEW
P120924	24	4,5	6
P120926	26	5,0	6 NEW
P120928	28	5,0	6
P120932	32	5,5	6
P120936	36	6,0	6 NEW

P128 Non-stick fry pan "HERCULES"
Sartén antiadherente "HERCULES"
Poêle anti-adhésive "HERCULES"



Plain base
Fondo plano
Fond plain

REF	Ø cm	H cm	Box
P128018	18	4,0	12
P128020	20	4,0	12
P128022	22	4,5	12
P128024	24	4,5	6
P128026	26	5,0	6
P128028	28	5,0	6
P128032	32	5,5	6
P128036	36	6,0	6
P128040	40	6,5	6

P120 Non-stick fry pan "ERGOS"
Sartén antiadherente "ERGOS"
Poêle anti-adhésive "ERGOS"

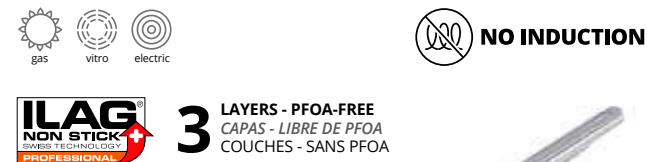

Plain base
Fondo plano
Fond plain

REF	Ø cm	H cm	Box
P120018	18	4,0	12
P120020	20	4,0	12
P120022	22	4,5	12
P120024	24	4,5	6
P120026	26	5,0	6
P120028	28	5,0	6
P120032	32	5,5	6
P120036	36	6,0	6
P120040	40	6,5	6

Aluminum 3.4

Aluminio
Aluminium



P128 Non-stick fry pan "HERCULES" Coloured handles
Sartén antiadherente "HERCULES" mango colores
Poêle anti-adhésif "HERCULES" Queue à couleurs



ALU CERAMIC

P1208 Fry pan with ceramic non-stick coating
Sartén con antiadherente cerámico
Poêle à revêtement anti-adhésif céramique



St/Steel sheet induction bottom
Fondo chapa inox. inducción
Fond plaque inox. induction

REF	Ø cm	H cm	Box
P120820	20	4,0	12
P120824	24	4,5	6
P120828	28	5,0	6
P120832	32	5,5	6

P124 Non-stick paella pan
Paellera antiadherente
Plat à paella anti-adhésif



St/Steel handle
Asas de acero inox
Anses en acier inox

REF	Ø cm	H cm	Box
P124024	24	4,5	1
P124028	28	5,0	1
P124032	32	5,5	1
P124036	36	6,0	1
P124040	40	6,5	1



- Red meat / Carnes rojas / Viande rouge
- White meat and eggs / Carnes blancas y huevos / Volaille et oeufs
- Fish / Pescado / Poisson
- Vegetables / Verdura / Legumes

Ref: P128 + (Colour / Color / Couleur) + Ø

REF	Red Rojo Rouge	Yellow Amarillo Jaune	Blue Azul Bleu	Green Verde Vert	Ø cm	H cm	Box
P128	1	2	3	4	24	4,5	12
P128	1	2	3	4	28	5,0	12
P128	1	2	3	4	32	5,5	6

ALU EXPERT

P127 Fry pan "ERGOS" expert
Sartén "ERGOS" expert
Poêle "ERGOS" expert



REF	Ø cm	H cm	Box
P127024	24	4,5	1
P127028	28	5,0	1
P127032	32	5,5	1
P127040	40	6,5	1

P148 Non-stick sauté pan "ERGOS"
Sartén honda "ERGOS" antiadherente
Sauteuse évasée en anti-adhésive "ERGOS"



REF	Ø cm	H cm	Box
P148020	20	6,5	1
P148024	24	7,0	1
P148028	28	7,5	1
P148032	32	8,0	1

3.4 Aluminum

Aluminio
Aluminium



P125 Non-stick FRY pan for fish "ERGOS"
Sartén pescado "ERGOS" antiadherente
Poêle à poisson "ERGOS" anti-adhésive



REF	cm	H cm	
P125038	38 x 26	5	1

P131 Non-stick crêpe fry pan "HERCULES"
Sartén para crêpes "HERCULES" antiadherente
Poêle à crêpes "HERCULES" anti-adhésive



REF	Ø cm	H cm	
P131022	22	2,5	12
P131026	26	2,5	12

P139 Non-stick blinis fry pan
Sartén para blinis antiadherente
Poêle à blinis anti-adhésive



IDEA! Specially for fried egg
Especial para huevo frito
Spécialement pour œuf frit

REF	Ø cm	H cm	
P139012	12	2	36

ALU FIRST

P1939 Non-stick light fry pan
Sartén antiadherente ligera
Poêle antiadhesive légère

NEW!

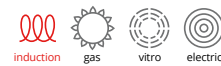

PFOA FREE
Non-stick coating
Antiadherente
Anti-adhésif

3,5 mm
Thickness
Espesor
Épaisseur



Sold in whole boxes only
Se venden sólo por cajas completas
Vendues uniquement par boîtes complètes

REF	Ø cm	H cm	
P193918	18	4,0	6
P193920	20	4,0	6
P193922	22	4,5	6
P193924	24	4,5	6
P193926	26	5,0	6
P193928	28	5,0	6
P193932	32	5,5	6
P193936	36	6,0	6

EASY APOLO

P460 Aluminium non-stick fry pan
Sartén aluminio antiadherente
Poêle aluminium anti-adhésive



2,5 mm
Thickness
Espesor
Épaisseur



Bakelite handle
Mango baquelita
Queue en bakélite

REF	Ø cm	H cm	
P460018	18	4,0	12
P460020	20	4,0	12
P460024	24	4,0	12
P460026	26	4,5	12
P460028	28	4,5	12
P460030	30	4,5	12
P460032	32	5,0	12



Multi-ply 3.5

Multimetal
Multi-metal



MULTI-PLY



It gets all advantages of the aluminium and the st/steel just in one

Aporta todas las ventajas del aluminio y del acero inoxidable en una sola pieza

Apporte tous les avantages de l'aluminium et de l'acier inoxydable en une seule pièce

P2390 Round base wok
P2394 Wok fondo redondo
Wok à fond rond

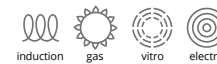

P239036



P239436*



* Non-stick coating / Antiadherente / Anti-adhésif

REF	Ø cm	H cm	Lts	
P239036	36	10	6	1
P239436*	36	10	6	1

P2391 Flat base wok
P2395 Wok fondo plano
Wok à fond plain

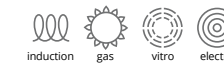

P239136



P239536*



* Non-stick coating / Antiadherente / Anti-adhésif

REF	Ø cm	H cm	Lts	
P239136	36	9	5,5	1
P239536*	36	9	5,5	1

3.6 Cast aluminum

Aluminio fundición
Fonte d'aluminium



BLACK PRO

Manufactured in cast aluminium with excellent resistance to deformation and with excellent thermal properties.

Fabricada en aluminio de fundición de gran resistencia a la deformación y con excelentes prestaciones térmicas.

Fabriqué en fonte d'aluminium très résistante à la déformation et dotée d'excellentes performances techniques.



Tubular stainless steel handle
Mango tubular de acero inoxidable
Manche tubulaire en acier inoxydable

Highly resistant Eterna non-stick surface
Antiadherente Eterna de alta resistencia
Antiadhesif permanent très résistant

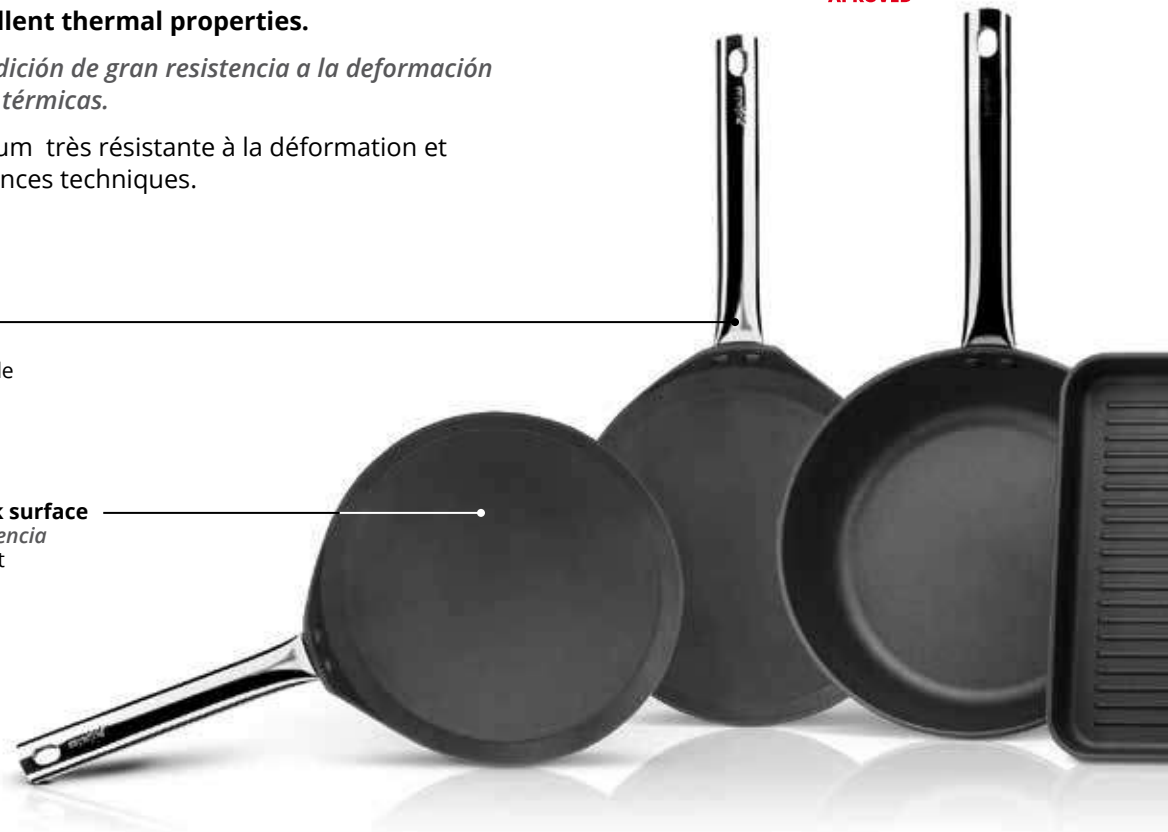

P1491 Fry pan st/steel handle
Sartén mango inox
Poêle manche inox

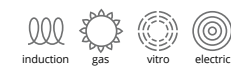

REF	Ø cm	H cm	
P149120	20	5	4
P149124	24	5	4
P149128	28	5	4
P149130	30	5	4

P1492 Deep fry pan st/steel handle
Sartén honda mango inox
Poêle haute manche inox

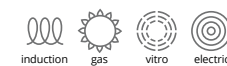

REF	Ø cm	H cm	
P149228	28	7,5	4

Cast aluminum 3.6

Aluminio fundición
Fonte d'aluminium



P1493 Wok st/steel handle
Wok mango inox
Wok manche inox

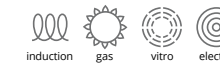

REF	Ø cm	H cm	
P149330	30	9,5	4

P1421 Grill st/steel handle
Asador grill mango inox
Grill manche inox

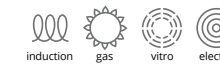

REF	W x D x H cm	
P142100	28 x 28 x 4	1

P153034 Hot-plate with handles
Parrilla plana con asas
Grill plat avec poignées



REF	W x D x H cm	
P153034	34 x 26 x 2,5	6

P1501 Crêpe fry pan st/steel handle
Sartén crêpes mango inox
Poêle à crêpes manche inox

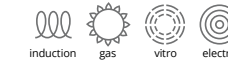

REF	Ø cm	H cm	
P150128	28	1,5	4

P153025 Hot-plate with handles
Parrilla plana con asas
Grill plat avec poignées



REF	W x D x H cm	
P153025	25 x 25 x 2	1

P153050 Hot-plate with handles
Parrilla plana con asas
Grill plat avec poignées



REF	W x D x H cm	
P153050	50 x 30 x 2,5	4

FRY PANS
SARTÉNS
POÊLES

FRY PANS
SARTÉNS
POÊLES

3.6 Cast aluminum

Aluminio fundición
Fonte d'aluminium



BLACK FORGED



FULL INDUCTION



P1495 Forged aluminium frying pan
Sartén aluminio forjado
Poêle en aluminium revêtu

FULL INDUCTION



REF	Ø cm	H cm	
P149520	20	5,0	1
P149524	24	5,5	1
P149528	28	6,0	1

Frying pan manufactured in high-resistance forged aluminium which offers excellent energy efficiency thanks to its full induction base with a soft-touch bakelite handle, resistant to temperatures up to 160 °C.

Sartén fabricada en aluminio forjado de alta resistencia que ofrece una gran eficiencia energética gracias a su fondo inducción completo, con mango de baquelita soft touch resistente a una temperatura máxima de 160 °C.

Poêle fabriquée en aluminium revêtu très résistant, offrant une grande efficacité énergétique, grâce à son fond à induction complet avec manche en bakélite soft touch résistant à une température maximale de 160°C.

BLACK FIRST

P150 Crêpe fry pan bakelite handle
Sartén crêpes mango baquelita
Poêle à crêpes manche bakélite



Cast aluminium
Aluminio de fundición
Fonte d'aluminium



REF	Ø cm	H cm	
P150028	28	2,0	12

NO INDUCTION

P142 Grill wooden handle
Asador grill mango madera
Grill queue en bois



Cast aluminium
Aluminio de fundición
Fonte d'aluminium



REF	W x D x H cm	
P142000	29 x 29 x 4,3	5

Steel 3.7

Acero
Acier



STEEL PRO 1921 SERIES



FULL INDUCTION

Heatproof ergonomic handle
Mango ergonómico, resistente al calor
Manche ergonomique, résistant à la chaleur

Light cast steel fry pan easy to use
Sartén de acero de fundición ligero de fácil manejo
Poêle en fonte d'acier léger, facile à manipuler

40%
Less weight than traditional iron pans
Menos de peso que las sartenes tradicionales de hierro

De poids en moins par rapport aux poêles en fer traditionnelles

Extraordinary calorific properties.
Excellent and uniform heat distribution
Extraordinarias propiedades calóricas. Excelente y homogénea distribución del calor
Propriétés calorifiques extraordinaires.
Excellent et homogène distribution de la chaleur

Last generation three layers non-stick coating. PFOA FREE
Tres capas de antiadherente de última generación, libre de PFOA
Trois couche anti-adhésive de dernière génération. Libre de PFOA

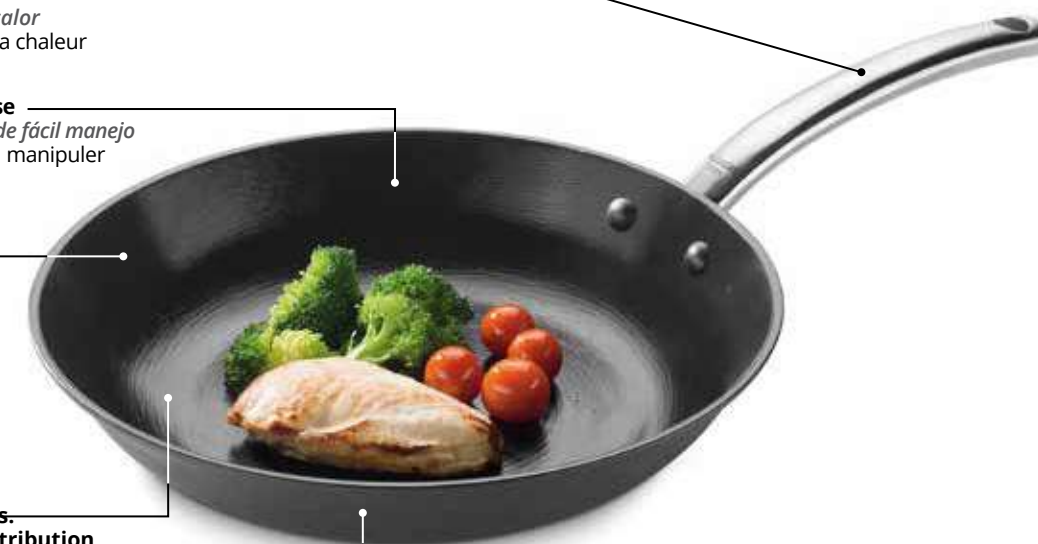

IDEA! For a quick and healthy cooking, it enables you to cook meats, fish, vegetables using high heat and very little oil.
Para una cocina rápida y sana, permite cocinar carnes, pescados y verduras a fuego alto, usando muy poco aceite.
Pour une cuisine rapide et saine, permettant de cuisiner les viandes, poissons et légumes à feu vif, en utilisant très peu d'huile.

P169 Fry pan
Sartén
Poêle

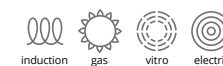

REF	Ø cm	H cm	
P169020	20	4,5	1
P169024	24	4,5	1
P169028	28	5,5	1
P169030	30	5,5	1

P166 Wok with lid
Wok con tapa
Wok avec couvercle

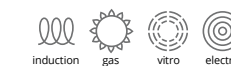

Glass lid included
Tapa de cristal incluida
Couvercle en verre inclus

REF	Ø cm	H cm	Lts	
P166032	32	8,0	4,40	1



St
Steel

Steel 3.7

Acero
Acier

STEEL EXPERT



Hercules long handle
Mango hércules
Manche hercules

Excellent thermal and natural nonstick properties
Excelentes propiedades térmicas y antiadherentes naturales
Excellentes propriétés thermiques et antiadhésives naturelles

Manufactured in steel
Fabricadas en acero
Fabriquées en acier



P1351 "Lyonnaise" Steel fry pan 1,5 mm
Sartén "Lionesa" 1,5 mm
Poêle "Lyonnaise" 1,5 mm



REF	Ø cm	H cm	📦
P135120	20	4,5	1
P135124	24	5,0	1
P135128	28	5,5	1
P135132	32	6,0	1
P135140	40	7,0	1

P1353 Wok



REF	Ø cm	H cm	📦
P135330	30	9,5	1

P1354 Crêpe fry pan
Sartén para crêpes
Poêle à crêpes



REF	Ø cm	H cm	📦
P135424	24	2,0	1

FRY PANS
SARTÈNS
POÊLES

3.8 Spanish paella pan

Paellera
Plat à paella



P994 Black steel spanish paella pan
Paellera valenciana en acero pulido
Plat à paella tôle acier



REF	Ø cm	Portions Raciones	📦
P994020	20	1	1
P994022	22	1	1
P994024	24	1	1
P994026	26	2	1
P994030	30	4	1
P994032	32	5	1
P994034	34	6	1
P994036	36	7	1
P994038	38	8	1
P994040	40	9	1
P994042	42	10	1
P994046	46	12	1
P994050*	50	14	1
P994055*	55	16	1
P994065*	65	22	1
P994080*	80	40	1
P994090*	90	50	1

* Models also available in 3mm thickness.
Modelos también disponibles en 3mm de grosor.
Modèles également disponibles en épaisseur 3 mm

P995 Enamelled steel paella pan
Paellera acero esmaltado
Plat à paella acier émaillé



REF	Ø cm	Portions Raciones	📦
P995010 *	10	-	1
P995016 *	15	-	1
P995020	20	2	1
P995026	26	2	1
P995030	30	4	1
P995034	34	6	1
P995036	36	7	1
P995038	38	8	1
P995040	40	9	1
P995042	42	10	1
P995050	50	14	1
P995060	60	19	1

P997 Deep enamelled fry pan with handles
Sartén honda esmaltada con asas
Poêle haute avec anses



REF	Ø cm	Lts	📦
P997014 *	14	0,40	1
P997016 *	16	0,50	1
P997028	28	3,90	1
P997032	32	5,30	1
P997036	36	7,80	1
P997040	40	9,40	1

***MINI-SIZE**
IDEA! Recommended for snacks
Ideal para tapas
Recommandé pour tapas



Spanish paella pan 3.8

Paellera
Plat à paella

Burners
Paelleros

P998 Enamelled gas burner
Paellero esmaltado gas
Brûleur émaillé



P998035
For paella pans from Ø 20 to 50 cm
Para paelleras de 20 a 50 cm Ø
Pour plats à paella de 20 à 50 cm Ø

P998050
For paella pans from Ø 36 to 70 cm
Para paelleras de 36 a 70 cm Ø
Pour plats à paella de 36 à 70 cm Ø

P998070
For paella pans from Ø 36 to 90 cm
Para paelleras de 36 a 90 cm Ø
Pour plats à paella de 36 à 90 cm Ø

Valid only for gas butane and propane
Válido para gas butano y propano NO para gas ciudad
Valable uniquement pour gaz butane et propane

REF	Ø cm	Circles Círculos Cercles	Kw	📦
P998035	35	2	9,4	1
P998050	50	2	14,1	1
P998070	70	3	24,1	1

P999 Base for burner
Tripode paellero
Pied pour brûleur



Folding valid for 2 and 3
circles burners
Plegable apto para paelleros
de 2 y 3 círculos
Pliant valable pour brûleurs
de 2 et 3 cercles

REF	📦
P999000	1

See products on / Ver productos en / Voir produits en page

P. 465



4 Oven and roasting pans

Horno y rustideras

Fouret plaques à rôtir



4.1 ROASTPANS 88

RUSTIDERAS

PLAQUES À RÔTIR

4.2 GASTRONORMSHEETPANS 89

BANDEJAS HORNO GASTRONORM

PLAQUES FOUR GASTRONORME

4.3 PASTRYTRAYS 90

BANDEJAS PASTELERÍA

PLAQUES À PÂTISSERIE

4.4 GRIDS 92

REJILLAS

GRILLES

4.5 PIZZAPANS 93

BANDEJAS PARA PIZZA

PLAQUES À PIZZA

4.6 OVEN ACCESSORIES 95

ACCESORIOS HORNO

ACCESSOIRES FOUR

4.1 Roast pans

Rustideras
Plaques à rôtir



P309 Roast pan falling handles
Rustidera asas móviles
Plaque à rôtir anses tombantes



REF	cm (int)	cm (ext)	H cm	Lts	
P309040	40 x 30	43 x 33	6,5	6,5	1
P309050	50 x 35	54 x 39	7,0	11,0	1
P309060	60 x 40	64 x 44	9,0	19,0	1

P113 Roast pan falling handles
Rustidera asas móviles
Plaque à rôtir anses tombantes



REF	W x D x H cm	Lts	
P113035	35 x 27 x 5,5	5,0	1
P113040	40 x 30 x 6,5	6,3	1
P113050	50 x 35 x 7	10,8	1
P113060	60 x 40 x 9	19,0	1
P113070	70 x 45 x 10	27,7	1

P122 Non-stick roast pan falling handles
Rustidera antiadherente asas móviles
Plaque à rôtir anti-adhésive anses tombantes



REF	W x D x H cm	Lts	
P122040	40 x 30 x 6,5	6,3	1
P122050	50 x 35 x 7	10,8	1
P122060	60 x 40 x 9	19,0	1

P114 Roast pan fixed handles
Rustidera asas fijas
Plaque à rôtir avec poignées fixes



REF	W x D x H cm	Lts	
P114040	40 x 30 x 6,5	6,3	1
P114050	50 x 35 x 7	10,8	1
P114060	60 x 40 x 9	19,0	1
P114070	70 x 45 x 10	27,7	1

P1145 BLACK ELEGANCE
Non-stick presentation aluminium roast pan
Rustidera aluminio presentación antiadherente
Plaque à rôtir anti-adhésive présentation



REF	W x D x H cm	Lts	
P114540	40 x 30 x 6,5	6,3	1
P114545	45 x 32 x 6,5	7,6	1

P152 Roast pan
Rustidera
Plaque à rôtir



*MINI-SIZE

Ideal for food presentation
Ideal para presentación
Idéal pour présentation

REF	W x D x H cm	
P152025*	25 x 20 x 6,5	10
P152030	30 x 22 x 7	10
P152035	35 x 25 x 7,5	5

Gastronorm sheet pans 4.2

Bandejas horno gastronorm
Plaques four gastronorme



P3180 Gastronorm sheet
Bandeja gastronorm
Plaque gastronorme



Thickness: 1 mm
Grosor: 1 mm
Epaisseur: 1 mm

REF	Type / tipo	W x D x H cm	
P318005	1/1	54 x 32 x 0,8	1

P3182 Deep gastronorm sheet
Bandeja honda gastronorm
Plaque gastronorme fonde



Thickness: 0,8 mm
Grosor: 0,8 mm
Epaisseur: 0,8 mm

REF	Type / tipo	W x D x H cm	
P318211	1/1	53 x 32,5 x 2	1

P1323 Non-stick GN pan tray
Bandeja GN antiadherente
Plaque GN anti-adhésive



Thickness: 3 mm
Grosor: 3 mm
Épaisseur: 3 mm

REF	Type / tipo	W x D x H cm	Lts	
P132365	1/1	53 x 32,5 x 6,5	7,9	1

P1325 Multi-units tray
Bandeja multiunidades
Plaque multi-unités

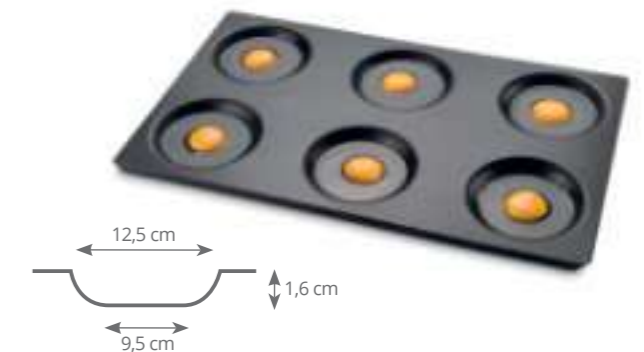

REF	Type / tipo	cm	
P132560	1/1	53 x 32,5	1

4.3 Pastry trays

Bandejas pastelería
Plaques à pâtisserie



18/10
Stainless steel

P318 Baking sheet

Bandeja pastelería
Plaques à pâtisserie



Thickness: 1 mm
Grosor: 1 mm
Épaisseur: 1 mm

REF	W x D x H cm	
P318040	40 x 30 x 1,2	1
P318060	60 x 40 x 1,2	1

P779 Baking sheet

Bandeja pastelería
Plaques à pâtisserie



Thickness: 0,7 mm
Grosor: 0,7 mm
Épaisseur: 0,7 mm

REF	W x D x H cm	
P779017	25,5 x 17,5 x 1	1
P779021	27,5 x 21 x 1	1
P779026	30 x 26 x 1	1
P779060	60 x 20 x 1	1

P778 Baking sheet

Bandeja pastelería
Plaques à pâtisserie



REF	W x D x H cm	
P778040	40 x 30 x 1	1
P778048	48 x 31 x 1	1
P778060	60 x 40 x 1	1

P777 Rectangle for baking sheets

Marcos para bandejas es cuadradas
Rectangle pour plaques



Rectangles that are adaptable to the baking sheets of ref. P778, P1232 and P1322
Marcos adaptables a las bandejas es cuadradas de la ref. P778, P1232 y P1322
Rectangles pour adapter aux plaques inox des refs. P778, P1232 et P1322

REF	W x D x H cm	
P777540	39,5 x 29,5 x 5	1
P777548	47,5 x 30,5 x 5	1
P777560	59,5 x 39,5 x 5	1

See products on / Ver productos en / Voir produits en page

P. 154

GN Pastry Pan
Cubeta GN Pastelería
Bac GN pâtisserie

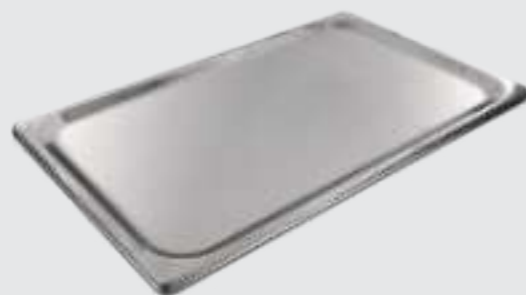

Pastry trays 4.3

Bandejas pastelería
Plaques à pâtisserie

Al
Aluminium

P123 Baking sheet

Bandeja pastelería
Plaques à pâtisserie



REF	W x D x H cm	
P123040	40 x 30 x 1,2	1
P123060	60 x 40 x 1,2	1

P1232 Baking sheet

Bandeja pastelería
Plaques à pâtisserie



REF	W x D x H cm	
P123260	60 x 40 x 1,2	1

P1321 Perforated non-stick baking sheet

Bandeja pastelería antiadherente perforada
Plaques à pâtisserie anti-adhésive perforée



Ø holes 3 mm
Ø agujeros 3 mm
Ø trous 3 mm

REF	W x D x H cm	
P132140	40 x 30 x 1,2	1
P132160	60 x 40 x 1,2	1

P1231 Perforated baking sheet

Bandeja perforada pastelería
Plaques à pâtisserie perforée



REF	W x D x H cm	
P123140	40 x 30 x 1,2	1
P123160	60 x 40 x 1,2	1

P132 Non-stick baking sheet

Bandeja pastelería antiadherente
Plaques à pâtisserie anti-adhésive



REF	W x D x H cm	
P132040	40 x 30 x 1,2	1
P132060	60 x 40 x 1,2	1

P1322 Non-stick baking sheet

Bandeja pastelería antiadherente
Plaques à pâtisserie anti-adhésive



REF	W x D x H cm	
P132260	60 x 40 x 1,2	1

4.4 Grids

Rejillas
Grilles



9002 Baking sheet

Bandeja pastelería
Plaque à pâtisserie



IDEA! 5220 / 5228
Ideal for food presentation
Ideal para presentación
Idéal pour présentation

REF	W x D x H cm	☐
9002	65,4 x 45,1 x 2,5	12
5223	53,3 x 38,1 x 2,5	12
5303	32,7 x 45,1 x 2,5	12
5220	33,0 x 24,1 x 2,5	12
5228	16,5 x 24,1 x 2,5	12

P9091 St/Steel gastronorm grid

Rejilla gastronorm acero inox
Grille acier inoxydable gastronorm



REF	Type tipo	cm	N. Cross-bars Travesaños Traverses	Ø mm Cross-bars Travesaños Traverses	N. Wires Varillas Fils	Ø mm Wires Varillas Fils	☐
P909121	2/1	65 x 53	3	5	32	2	10
P909111	1/1	53 x 32,5	2	5	20	2	10

P9093 St/Steel pastry grid

Rejilla pastelería acero inox
Grille pâtisserie acier inoxydable



REF	cm	N. Cross-bars Travesaños Traverses	Ø mm Cross-bars Travesaños Traverses	N. Wires Varillas Fils	Ø mm Wires Varillas Fils	☐
P909340	40 x 30	2	5	22	2	10
P909360	60 x 40	3	5	29	2	10

P9094 St/Steel reinforced pastry grid

Rejilla pastelería reforzada acero inox
Grille pâtisserie acier inoxydable renforcée



REF	cm	N. Cross-bars Travesaños Traverses	Ø mm Cross-bars Travesaños Traverses	N. Wires Varillas Fils	Ø mm Wires Varillas Fils	☐
P909460	60 x 40	2	6	24	3	10

P9092 White rilsan steel gastronorm grid

Rejilla gastronorm con rilsan blanco
Grille gastronorm en acier et rilsan blanc



oven



REF	Type tipo	cm	N. Cross-bars Travesaños Traverses	Ø mm Cross-bars Travesaños Traverses	N. Wires Varillas Fils	Ø mm Wires Varillas Fils	☐
P909221	2/1	65 x 53	3	5	22	5	1
P909211	1/1	53 x 32,5	2	5	13	5	1

Pizzapans 4.5

Bandejas para pizza
Plaques à pizza



6706CC Pizza pan with Clear Coat® finish

Bases pizza con acabado Clear Coat®
Bases pizza finition Clear Coat®

REF	Ø cm	H cm	☐
6706CC	16	3,8	12
6708CC	20	3,8	12
6709CC	22	3,8	12
6710CC	25	3,8	12
6712CC	30	3,8	12
6714CC	35	3,8	12
6716CC	40	3,8	12
PC07SCC	18	1,9	12
PC09SCC	22	1,9	12
PC10SCC	25	1,9	12
PC12SCC	30	1,9	12
PC15SCC	38	1,9	12
PC18SCC	45	1,9	12

6706HC Pizza pan with Hard Coat® finish

Bases pizza con acabado Hard Coat®
Bases pizza finition Hard Coat®

REF	Ø cm	H cm	☐
6706HC	16	3,8	12
6708HC	20	3,8	12
6714HC	35	3,8	12
6716HC	40	3,8	12
PC07SHC	18	1,9	12
PC08SHC	20	1,9	12
PC09SHC	22	1,9	12
PC10SHC	25	1,9	12
PC11SHC	28	1,9	12
PC13SHC	32	1,9	12
PC14SHC	35	1,9	12
PC16SHC	40	1,9	12

6706N Pizza pan with natural finish

Bases pizza con acabado natural
Bases pizza finition naturel

REF	Ø cm	H cm	☐
6706N	16	3,8	12
6708N	20	3,8	12
6709N	22	3,8	12
6710N	25	3,8	12
6712N	30	3,8	12
6714N	35	3,8	12
6716N	40	3,8	12
PC07SN	18	1,9	12
PC08SN	20	1,9	12
PC10SN	25	1,9	12
PC11SN	28	1,9	12
PC12SN	30	1,9	12
PC13SN	32	1,9	12
PC15SN	38	1,9	12
PC18SN	45	1,9	12

PC07PCC Perforated pizza pan with Clear Coat® finish

Bases pizza perforadas con acabado Clear Coat®
Bases pizza perforées finition Clear Coat®

REF	Ø cm	H cm	Holes Agujeros Trous	☐
PC07PCC	18	1,9	32	12
PC08PCC	20	1,9	52	12
PC10PCC	25	1,9	80	12
PC11PCC	28	1,9	112	12
PC12PCC	30	1,9	124	12
PC13PCC	33	1,9	156	12
PC14PCC	35	1,9	360	12
PC15PCC	38	1,9	208	12
PC18PCC	45	1,9	316	12

PC07PHC Perforated pizza pan with Hard Coat® finish

Bases pizza perforadas con acabado Hard Coat®
Bases pizza perforées finition Hard Coat®

REF	Ø cm	H cm	Holes Agujeros Trous	☐
PC07PHC	18	1,9	32	12
PC10FPHC	25	1,9	164	12
PC11PHC	28	1,9	112	12
PC12FPHC	30	1,9	256	12
PC12PHC	30	1,9	124	12
PC13PHC	33	1,9	156	12
PC14FPHC	35	1,9	360	12
PC14PHC	35	1,9	360	12
PC15PHC	38	1,9	208	12
PC16FPHC	40	1,9	468	12
PC18FPHC	45	1,9	616	12

PC08PN Perforated pizza pan with natural finish

Bases pizza perforadas con acabado natural
Bases pizza perforées finition naturel

REF	Ø cm	H cm	Holes Agujeros Trous	☐
PC08PN	20	1,9	52	12
PC10PN	25	1,9	80	12
PC11PN	28	1,9	112	12
PC12PN	30	1,9	124	12
PC14PN	35	1,9	360	12
PC15PN	38	1,9	208	12
PC16PN	40	1,9	468	12
PC18PN	45	1,9	316	12

4.5 Pizzapans

Bandejas para pizza
Plaques à pizza

P705 Non-stick deep pizza mould
Molde hondo pizza antiadherente
Moule haut pizza anti-adhésif



non-stick
antiadherente
antiadhésif



REF	Ø cm	H cm	
P705024	24	2,5	50
P705028	28	2,5	30
P705032	32	2,5	24

P736 Perforated non-stick pizza mould
Molde pizza antiadherente perforado
Moule à pizza anti-adhésif perforé



Ø 8 mm
Holes
Agujeros
Trous



REF	Ø cm	H cm	
P736030	30	1,3	1
P736034	34	1,3	17

P949 Non-stick aluminium pizza grill
Base rejilla aluminio antiadherente para pizza
Base maillée aluminium anti-adhésive pour pizza



REF	Ø cm	
P949025	25,5	60
P949030	30,5	60
P949035	35,5	60
P949040	40,0	60

P929 Aluminium pizza pan
Base pizza aluminio
Plaque à pizza aluminium



REF	Ø cm	
P929025	25	100
P929028	28	1
P929030	30	50
P929036	36	50
P929040	40	50

P963 Aluminium pizza grill
Base rejilla aluminio para pizza
Base maillée aluminium pour pizza



REF	Ø cm	
P963025	25,0	144
P963030	30,5	144
P963035	35,5	72
P963040	40,0	72

Oven accessories 4.6

Accesorios horno
Accessoires four

P833 Non-stick silicone mat
Tapete de silicona
Toile de cuisson



- 40 °C
+ 260 °C

REF	cm	
P833001	52 x 31,5	100
P833002	58,5 x 38,5	90
P833003	40 x 30	200

P6071 Rost pan tong w/silicon protection
Pinza rustidera c/proteccion silicona
Pinze plaque a/protection silicone



REF	L cm	
P607100	18	120

P948 Aluminium pizza peel
Pala pizza de aluminio
Pelle à pizza en aluminium



P972 Siliconized baking release papers
Papel siliconado
Papier siliconé anti-adhésif



Set of 500 units both sides siliconized. Multiple uses.
Grammage 41 gr/m². Greaseproof. Bleached.

Caja de 500 unidades. Siliconado por las dos caras. Múltiples usos.
Gramaje 41 gr/m². Resistente a la grasa. Color blanco.

Boîte de 500 unités. Deux faces siliconées. Multiples utilisations.
Grammage 41 gr/m². Résistant à la graisse. Couleur blanc.

REF	cm	Unit / Unidades	
P972060	60 x 40	500	1
P972053	53 x 32,5	500	1

P607 Roast pan tong
Pinza fuente horno
Pince pour plaque à rôtir



REF	L cm	
P607000	19	10

REF	Peel / Pala / Pelle cm	L cm	
P948066	31 x 35	66	24
P948090	31 x 35	90	24
P948132	31 x 35	132	24

5 Kitchen utensils

Utensilios de cocina
Ustensiles de cuisine

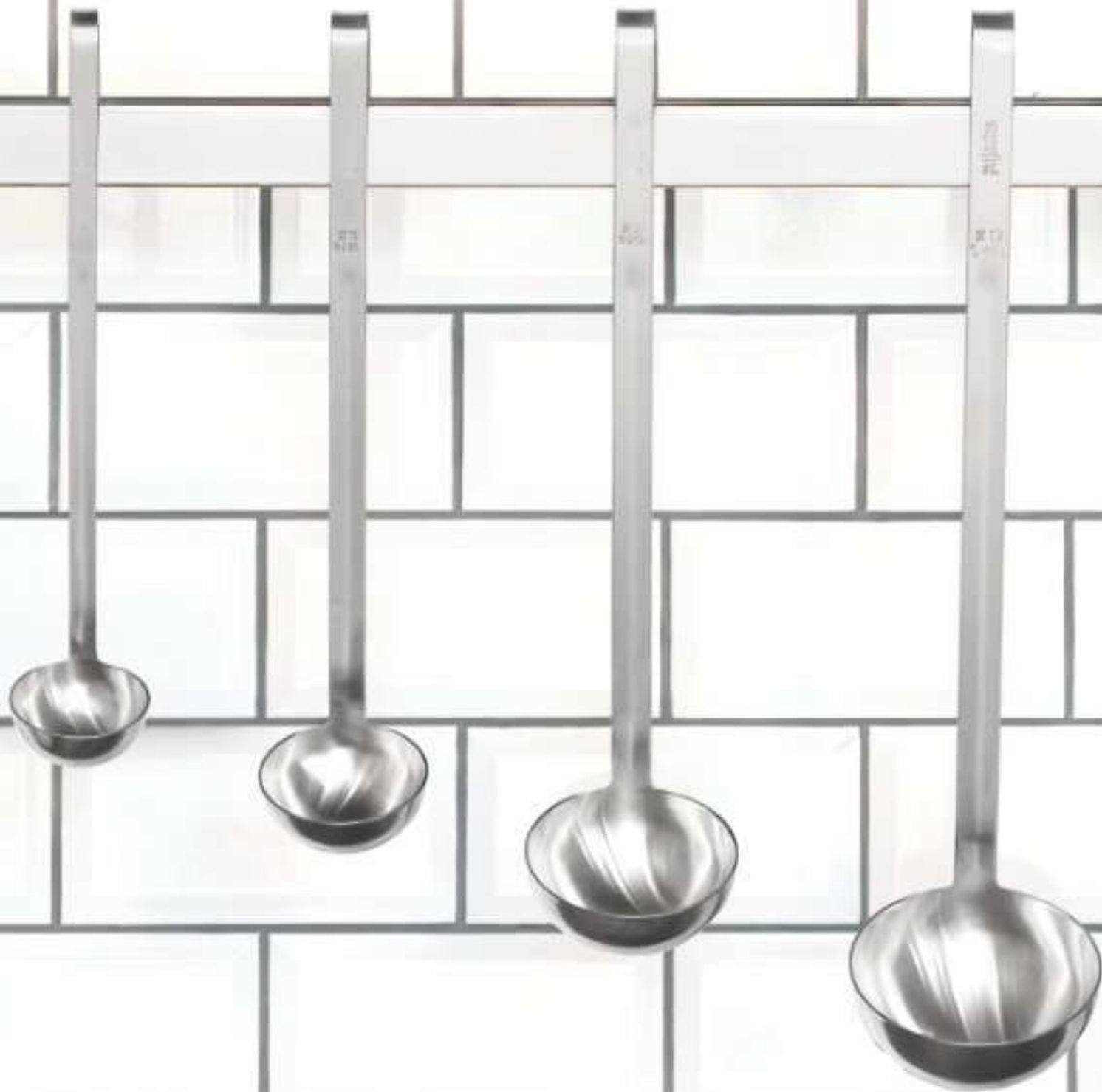

5.1 KITCHEN UTENSILS 98

UTENSILIOS DE COCINA
USTENSILES DE CUISINE

5.2 MANUAL FOOD PROCESSORS 125

PROCESADORES MANUALES DE ALIMENTOS
APPAREILS MANUELS DE TRANSFORMATION DES ALIMENTS

5.3 CUTTING BOARDS 140

TABLAS DE CORTE
PLANCHES À DÉCOUPER

5.4 MEASURING UTENSILS 143

ELEMENTOS DE MEDIDA
USTENSILES DE MESURE

5.5 MITT 149

MANOPLA
GAN

5.6 NATURAL RUBBER MATS 149

ALFOMBRAS CAUCHO
TAPIS EN CAOUTCHOUC

5.1 Kitchen utensils

Utensilios de cocina
Ustensiles de cuisine

P3011 One piece ladle Cacillo monobloc Louche monobloc



Capacity marked on the handle
Capacidad marcada en el mango
Capacité marqué à la queue



Ref	Ø cm	L cm	Lts	☐
P301165	6,5	31	0,07	120
P301108	8,0	32	0,13	80
P301109	9,0	33	0,20	60
P301110	10,0	37	0,25	40
P301112	12,0	42	0,45	30
P301114	14,0	43	0,75	20
P301116	16,0	45	1,00	20
P301118	18,0	48	1,50	20

P3012 Economical one piece ladle Cacillo monobloc económico Louche monobloc économique



Capacity marked on the handle
Capacidad marcada en el mango
Capacité marqué à la queue



Ref	Ø cm	L cm	Lts	☐
P301206	6	27	0,05	120
P301208	8	31	0,12	100
P301210	10	33	0,25	60
P301212	12	36	0,42	50
P301214	14	39	0,75	40
P301216	16	43	1,20	20

P392 One piece sauce ladle with 2 spouts Cacillo para salsas con 2 picos laterales Cuillère à sauces monobloc avec 2 becs verseurs



Capacity marked on the handle
Capacidad marcada en el mango
Capacité marqué à la queue



Ref	Ø cm	L cm	Lts	☐
P392065	6,5	31	0,08	120

P30326 One piece ladle short handle Cacillo monobloc mango corto Louche monobloc manche court



Capacity marked on the handle
Capacidad marcada en el mango
Capacité marqué à la queue



Ref	Ø cm	L cm	Lts	☐
P303265	6,5	22	0,07	120

4980120 One-Piece ladle Kool-Touch® handle Cacillo monobloc Kool-Touch® Louche monobloc manche Kool-Touch®



Coated handle
Revestimiento mango
Revêtement queue

Ref	Color	Ø cm	L cm	ml	☐
4980120	Black	4,5	25,0	30	12
4980230	Blue	6,0	25,0	60	12
4980335	Yellow	7,5	32,0	90	12
4980445	Grey	8,5	32,0	120	12
4980655	Green	9,0	31,5	175	12
4980865	Orange	10,0	32,0	235	12



Kitchen utensils 5.1

Utensilios de cocina
Ustensiles de cuisine



P3021 One piece skimmer Espumadera monobloc Écumoire monobloc

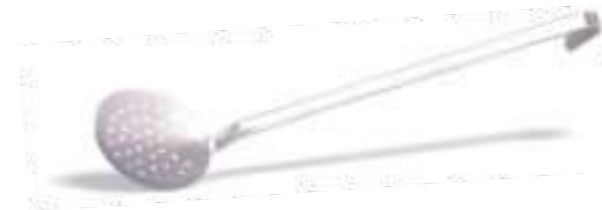

Ref	Ø cm	L cm	☐
P302108	8	29	100
P302110	10	32	80
P302112	12	35	60
P302114	14	37	40
P302116	16	44	40
P302118	18	44	30
P302120	20	47	30

P3022 Economical one piece skimmer Espumadera monobloc económica Écumoire monobloc économique



Ref	Ø cm	L cm	☐
P302210	10	33	100
P302212	12	36	50
P302214	14	39	40
P302216	16	42	40

P3141 One piece spatula Espátula monobloc sin perforar Spatule monobloc



Ref	Ø cm	L cm	☐
P314110	10	36	50
P314112	12	39	50

P3142 One piece perforated spatula Espátula monobloc perforada Spatule monobloc perforée



Ref	Ø cm	L cm	☐
P314210	10	36	50
P314212	12	39	50

P3143 One piece fish spatula Pala pescado monobloc Pelle à poisson monobloc



Ref	cm	L cm	☐
P314300	16 x 12	42	1

P315 Mesh skimmer Espumadera de alambre Écumoire à friture



Ref	Ø cm	L cm	☐
P315010	10	40,0	72
P315012	12	43,0	72
P315015	15	50,0	72
P315017	17	54,0	36
P315020	20	61,5	36

5.1 Kitchen utensils

Utensilios de cocina
Ustensiles de cuisine



P94101 Wire skimmer
Araña
Araignée



REF	Ø cm	L cm	
P941013	13	47,5	60
P941015	15	49,5	60
P941018	18	52,5	40
P941020	20	54,5	40
P941022	22	67,0	40
P941024	24	69,0	40
P941028	28	69,0	40

P955 Mesh skimmer
Espumadera malla fina
Écumoire maillée



Detail of the sieve at real scale
Detalle de la malla a escala real
Détail de la maille à échelle réelle

REF	Ø cm	L cm	
P955010	10	40	72
P955012	12	43	72
P955015	15	50	72
P955017	17	54	36
P955020	20	61	36

P394 Bird nest mould
Molde nido
Moule à nid

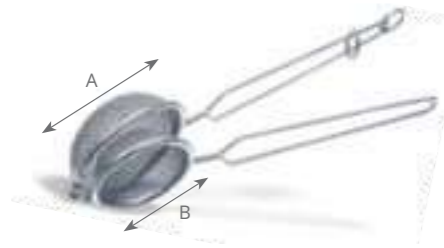

REF	Ø A cm	Ø B cm	
P394008	10	8	72
P394012	12	10	72

P376 Professional one piece spoon
Cuchara monobloc profesional
Cuillère monobloc professionnelle



REF	Ø cm	
P376037	37	1

P3761 Professional one piece deep spoon
Cuchara honda monobloc profesional
Cuillère profonde monobloc professionnelle



REF	Ø cm	
P376137	37	100

P377 Professional one piece perforated spoon
Cuchara perforada monobloc profesional
Cuillère perforée monobloc professionnelle



REF	Ø cm	
P377037	37	1

Kitchen utensils 5.1

Utensilios de cocina
Ustensiles de cuisine



P3771 Professional one piece perforated deep spoon
Cuchara honda monobloc profesional perforada
Cuillère profonde monobloc professionnelle perforée



REF	Ø cm	
P377137	37	101

P395 One piece crosswire spoon
Cuchara oblicua monobloc
Cuillère oblique monobloc



REF	L cm	BASE cm	Lts	
P395038	38	10 x 7	0,075	1

P3972 2 prongs one piece meat fork
Tenedor monobloc 2 púas
Fourchette monobloc 2 dents



2 prongs / 2 púas / 2 dents

REF	Ø cm	
P397247	47	1

P3973 3 prongs one piece meat fork
Tenedor monobloc 3 púas
Fourchette monobloc 3 dents



3 prongs / 3 púas / 3 dents

REF	L cm	
P397347	47	1

64130 Solid spoons
Cuchara
Cuillères pleines



232 °C

REF	Color	L cm	
64130	Black	35	12
6414015	White	35	12
6414030	Blue	35	12
6414040	Red	35	12
6414050	Yellow	35	12
6414070	Green	35	12

64132 Perforated spoons
Cuchara perforada
Cuillères perforées



232 °C

REF	Color	L cm	
64132	Black	35	12
6414215	White	35	12
6414230	Blue	35	12
6414240	Red	35	12
6414250	Yellow	35	12
6414270	Green	35	12

64134 Slotted serving Spoon
Cuchara de servir ranurada
Cuillère de service fendue

NEW!



REF	Color	L cm	
64134	Black	35	12

Antimicrobial

Utensils with nature's antimicrobial

Utensilios con propiedades antimicrobiales naturales

Ustensiles avec traitement antimicrobien

It is not difficult to imagine the large number of microbes and micro-organisms that can live on the handles of kitchen utensils. Vollrath Pujadas has launched a range of tools that prevent them from reproducing, thanks to AGIO technology, with silver ions that hold on to the bacteria and prevent them reproducing.

No es difícil imaginar la gran cantidad de microbios y micro-organismos que se pueden alojar en los mangos de los utensilios de cocina. Vollrath Pujadas lanza una gama de herramientas que evita que éstos se reproduzcan, gracias a la tecnología AGIO, con iones de plata que retienen las bacterias y evitan su reproducción.

Il n'est pas difficile d'imaginer le grand nombre de microbes et de microorganismes présents sur les manches des ustensiles de cuisine. Vollrath Pujadas lance une gamme d'ustensiles qui empêchent leur reproduction, grâce à la technologie AGIO, aux ions d'argent qui stoppent les bactéries et empêchent leur reproduction.

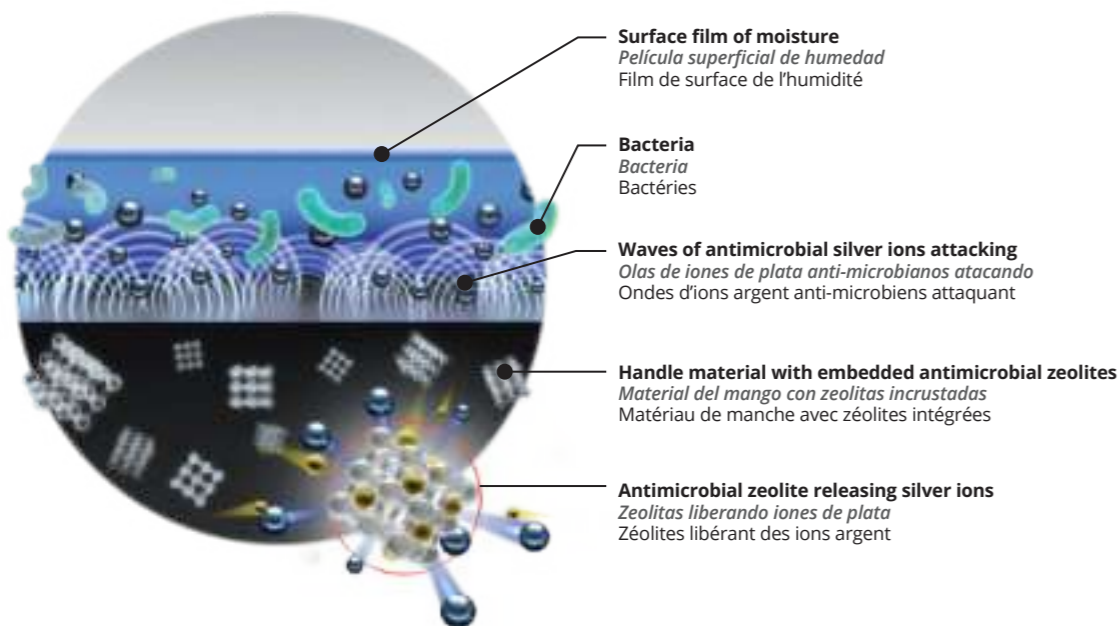

SPOODLE®

Mirror-finished stainless steel shafts and bowls resistant to corrosion

Mango y porcionadores de acero inoxidable brillante resistente a la corrosión

Tiges et cuillerons en acier inoxydable ultra-brillant résistant à la corrosion

Capacity marked on the handle

Capacidad marcada en el mango

Capacité marqué à la queue

Handle with ergonomic design, made from nylon which reduces wear during use. Maximum temperature 232 °C

Mango con diseño ergonómico, de Nylon que reduce la fatiga durante su uso. Max. temp. 232 °C

Manche au design ergonomique en nylon qui réduit la fatigue pendant son emploi. Temp. Max. 232 °C

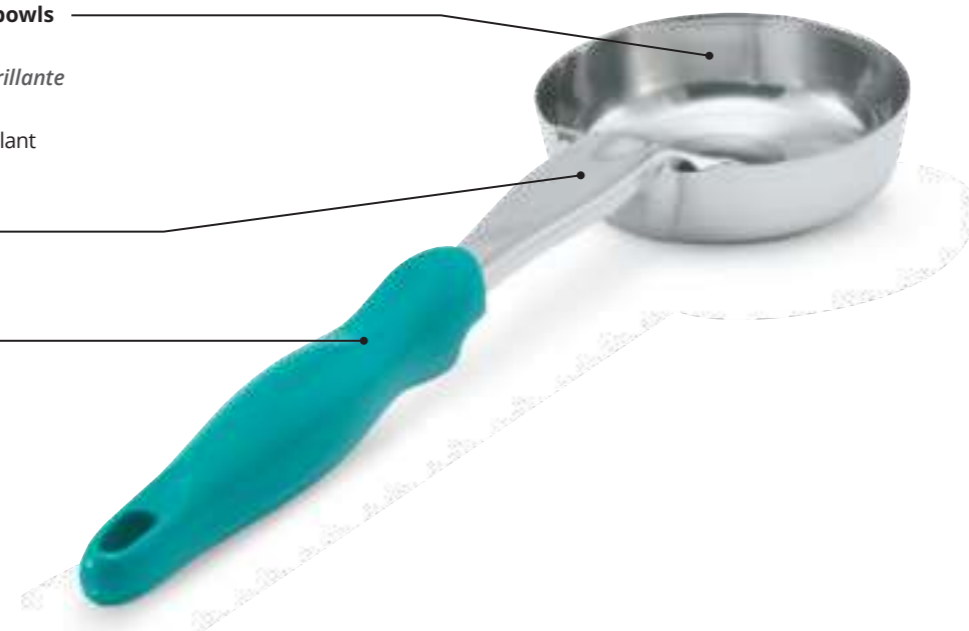

Kitchen utensils 5.1

Utensilios de cocina

Ustensiles de cuisine

6433 One-piece round Spoodle®
Spoodle® monobloc redondo
Spoodle® monobloc ronde



REF	Color	Ø cm	L cm	ml	Box
6433120	Black	5,0	31	29	12 NEW
6433220	Black	6,5	32	60	12 NEW
6433230	Blue	6,5	32	60	12
6433335	Orange	7,4	33	90	12
6433445	Grey	8,2	34	120	12
6433480	Purple	3,2	33	118	12 NEW
6433620	Black	9,3	35	177	12 NEW
6433655	Teal	9,3	35	175	12
6433865	Orange	10,2	36	235	12

6412 One-piece oval Spoodle®
Spoodle® Monobloc ovalado
Spoodle® Monobloc ovale



REF	Color	L cm	ml	Box
6412120	Black	32	29	12
6412230	Blue	33	59	12
6412335	Orange	34	88	12
6412420	Black	34	88	12
6412445	Grey	35	118	12
6412520	Black	35	147	12
6412655	Teal	36	177	12
6412865	Orange	37	236	12

6422 Perforated oval Spoodle®
Spoodle® perforado ovalado
Spoodle® perforé ovale



REF	Color	L cm	ml	Box
6422220	Black	33	59	12
6422335	Orange	34	88	12
6422655	Teal	36	177	12
6422865	Orange	37	236	12

6432 Perforated round Spoodle®
Spoodle® redondo perforado
Spoodle® perforé ronde



REF	Color	Ø cm	L cm	ml	Box
6432120	Black	5,2	31	29	12
6432220	Black	6,5	32	59	12
6432230	Blue	6,5	32	59	12
6432335	Orange	7,4	33	88	12
6432420	Black	8,2	34	118	12
6432445	Grey	8,2	34	118	12

5.1 Kitchen utensils

Utensilios de cocina
Ustensiles de cuisine

47390 Squeeze disher
Porcionador apretable
Cuillère-pression de service



REF	Color	Size / Tamaño	Ø cm	ml	
47370	○	6	7,6	138	12 NEW
47390	○	6	7,3	139	12
47371	○	8	7,3	109	12 NEW
47391	●	8	7,3	110	12
47372	●	10	7,0	95	12 NEW
47392	●	10	7,0	96	12
47393	●	12	6,4	84	12
47394	●	14	6,0	71	12 NEW
47395	●	16	5,7	59	12
47396	●	20	5,2	53	12
47397	●	24	4,8	45	12
47398	●	30	4,4	33	12
47399	●	36	4,4	28	12
47400	●	40	4,1	21	12 NEW
47401	●	50	3,8	19	12 NEW
47402	●	60	3,5	16	12 NEW
47403	●	70	3,2	14	12
47404	●	100	2,9	10	12 NEW

47139 Thumb disher
Porcionador
Cuillère de service



REF	Color	Size / Tamaño	Ø cm	ml	
47139	○	6	7,6	158	12
47140	●	8	7,3	118	12
47141	●	10	7,0	96	12
47142	●	12	6,4	79	12
47143	●	16	5,7	59	12
47144	●	20	5,2	48	12
47145	●	24	4,8	39	12
47146	●	30	4,4	30	12

Kitchen utensils 5.1

Utensilios de cocina
Ustensiles de cuisine

5283520 Round black Spoodle
Spoodle redondo negro
Spoodle round noir



REF	Ø cm	L cm	ml	
5283520	7,1	30,7	88	12
5283720	8,4	31,4	118	12
5283920	9,1	31,9	177	12

5283620 Perforated black round Spoodle
Spoodle redondo perforado negro
Spoodle rond perforé noir



REF	Ø cm	L cm	ml	
5283620	7,1	30,7	88	12

5292620 Black oval Spoodle
Spoodle ovalado negro
Spoodle ovale noir



REF	L cm	ml	
5292620	7,6	30,7	12

5284220 Nylon spoon
Cuchara nylon
Cuillère nylon



REF	Color	L cm	
5284220	■	34	12
5284320	■	34	12

4689760 Nylon spoon for preparation
Cuchara nylon para preparación
Cuillère nylon pour préparation



REF	Color	L cm	
4689760	■	21,6	12
4689815	■	30,5	12
4689830	■	30,5	12
4689840	■	30,5	12
4689850	■	30,5	12
4689860	■	30,5	12
4689960	■	38,1	12

See products on / Ver productos en / Voir produits en page

P. 322



Ice-cream and beverage solutions
Soluciones para la heladería
Solutions pour glaciers



18/10
Stainless
steel

Kitchen utensils 5.1

Utensilios de cocina
Ustensiles de cuisine



Plating tongs for careful lifting, turning and decorating
Pinzas ideales para emplatar y decorar
Pinces idéales pour la présentation et la décoration

P3434 Extra long fine tip straight tweezer (narrow)
Pinza chef precisión extra larga (fina)
Pince du chef précision extra long (étroite)



REF **P343400** L cm 30  72

P3436 Fine tip straight tweezer
Pinza chef precisión
Pince du chef précision



REF **P343600** L cm 21  288

P3437 Small fine tip straight tweezer
Pinza Chef precisión pequeña
Pince du chef précision petite

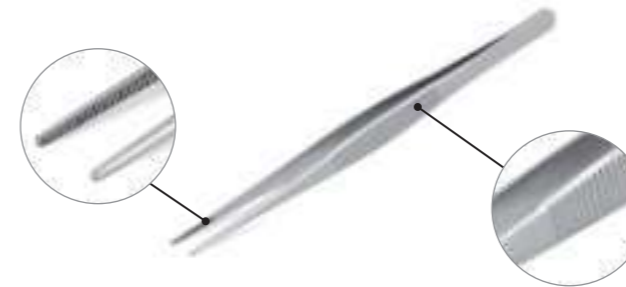

REF **P343700** L cm 16  288

P3438 Sushi tweezer
Pinza sushi
Pince à sushi



REF **P343800** L cm 16  288

See products on / Ver productos en / Voir produits en page

P. 167

Ice cream cake ring
Aro redondo para tarta
Cercle à vacherin



5.1 Kitchen utensils

Utensilios de cocina
Ustensiles de cuisine



P358 INOX Utility tong

Pinza buffet
Pince buffet

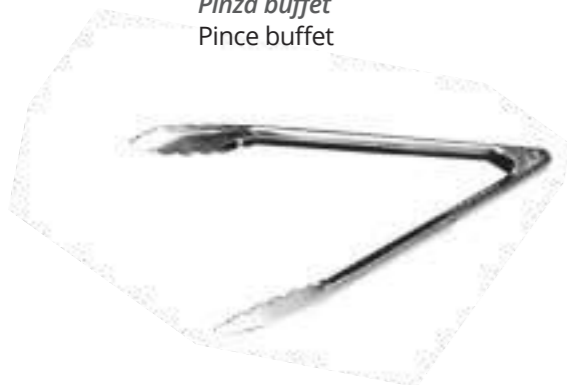

REF	L cm	
P358024	24	72
P358029	30	72
P358040	40	72

473 Heavy duty utility tongs

Pinzas inox servicio pesado
Pinces inox service lourd



REF	L cm	
47309	24	12
47312	30	12
47316	40	12

P358 COLOR Utility tong coloured handle

Pinza buffet inox mango color
Pince buffet inox manche couleur



Made of one piece St/Steel. Handle with PVC coating for a better grip and insulation.

Fabricadas en acero inoxidable monobloc. Mango con revestimiento PVC aislante para una mejor sujeción.

Fabriquées en acier inoxydable monobloc. Manche avec revêtement PVC pour une meilleure préhension et isolation.

Ref : P358 + L + Colour / Color / Couleur

Ref	L cm	White Blanco Blanc	Red Rojo Rouge	Blue Azul Bleu	Yellow Amarillo Jaune	Green Verde Vert	Brown Marrón Marron	Black Negro Noir	
P358	24	1	2	3	4	5	6	7	120
P358	30	1	2	3	4	5	6	7	120
P358	40	-	-	-	4	-	-	7	120

Kitchen utensils 5.1

Utensilios de cocina
Ustensiles de cuisine



Made of a single piece of stainless steel, in a W form to ensure maximum resistance and durability.

Fabricadas en acero inox, de una sola pieza, en forma de W que aseguran una máxima resistencia y durabilidad.

Fabriquées en acier inox, en une seule pièce, en forme de W, garantissant une résistance et une durabilité maximums.



4780920 One-Piece utility tong Kool-Touch®

Pinza buffet monobloc Kool-Touch®
Pince buffet Kool-Touch®



REF	Color	L cm	
4780920		24	12
4781220		30	12
4781620		40	12
4780930		24	12
4781230		30	12
4781630		40	12
4780940		24	12
4781240		30	12
4781640		40	12
4780950		24	12
4781250		30	12
4781650		40	12
4780960		24	12
4781260		30	12
4781660		40	12
4780970		24	12
4781270		30	12
4781670		40	12
4780980		24	12 NEW
4781280		30	12 NEW

4780620 One-Piece tong Kool-Touch®

Pinza buffet monobloc Kool-Touch®
Pince buffet inox Kool-Touch®

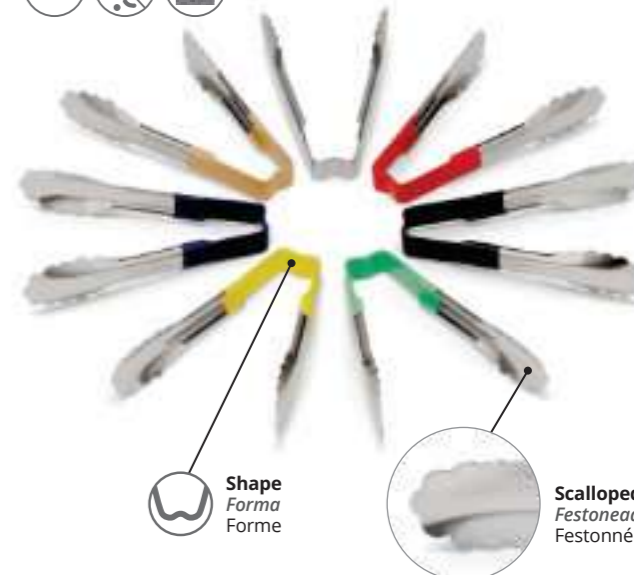

Shorter utility tong for tight spaces or delicate food applications

Pinza más corta para espacios estrechos o comida delicada

Pince utilitaire courte pour espaces restreints ou aliments délicats à manipuler

REF	Color	L cm	
4780620		15	12
4780630		15	12
4780640		15	12
4780650		15	12
4780660		15	12
4780670		15	12

5.1 Kitchen utensils

Utensilios de cocina
Ustensiles de cuisine

4780610 Stainless steel tong
Pinza de acero inoxidable
Pince inoxydable



Scalloped
Festoneada
Festonné



Shape
Forma
Forme

* Shorter utility tong for tight spaces or delicate food applications
* Pinza mas corta para espacios estrechos o comida delicada
* Pince utilitaire courte pour espaces restreints ou aliments delicats a manipuler

REF	L cm	
4780610*	15,2	12
4780910	24,1	12
4781210	30,5	12
4781610	40,6	12

4780912 Utility tong with nylon end
Pinza con extremo de nylon
Pince utilitaire avec extrémité nylon



Shape
Forma
Forme

Scalloped
Festoneada
Festonné

REF	L cm	
4780912	24	12
4781212	30	12
4781612	40	12

4791210 VERSAGRIP® Stainless steel tong
Pinza VERSAGRIP® de acero inoxidable
Pince inox VERSAGRIP®



Shape
Forma
Forme

4781622 Utility tong with nylon end
Pinza con extremo de nylon
Pince utilitaire avec extrémité nylon



Shape
Forma
Forme



Scalloped
Festoneada
Festonné

NEW!

REF	L cm	
4781622	40	12
4780922	24	12
4781222	30	12

47326 Kool-Touch® Reinforced Pom Tong
Pinza dentada reforzada Kool-Touch®
Pince ceinture renforcée Kool-Touch®



One-piece construction
Construcción de una sola pieza
Construction monobloc



Ideal for ovens, grills and barbecues
Ideal para hornos, brasa y barbacoa
Idéal pour fours, grill et barbecue

REF	L cm	
47326	15,2	12
47322	30,0	12

REF	L cm	
4790910	24,0	12 NEW
4791210	30,5	12
4791610	40,6	12

VERSAGRIP®
Features flattened ends and gripper teeth.
Presenta extremos aplanados y dentados para mayor agarre.
Offre des extrémités aplaties et crantées pour une meilleure prise.

Kitchen utensils 5.1

Utensilios de cocina
Ustensiles de cuisine

47046 Reinforced Pom Tong
Pinza dentada reforzada
Pince ceinture renforcée



One-piece construction
Construcción de una sola pieza
Construction monobloc



Ideal for ovens, grills and barbecues
Ideal para hornos, brasa y barbacoa
Idéal pour fours, grill et barbecue

REF	L cm	
47046	15,2	36
47049	22,9	24

P611 Pom tong
Pinza dentada
Pince ceinture



Ideal for ovens, grills and barbecues
Ideal para hornos, brasa y barbacoa
Idéal pour fours, grill et barbecue

REF	L cm	
P611001	24	288

P620 Chip bagger
Pala chips
Pelle à frites



Right hand
Mano derecha
Main droite

REF	cm	
P620001	23 x 21	1

P621 ABS chip bagger
Pala chips ABS
Pelle à frites en ABS



+ 80 °C



REF	cm	
P621000	23 x 21	36

47325 Heavy-Duty scissor tongs
Pinza tipo tijeras de uso intensivo
Pincas type ciseaux à usage intensif



REF	Color	L cm	
47325		38	12

5.1 Kitchen utensils

Utensilios de cocina
Ustensiles de cuisine

4808820 Solid Turner
Espátula reforzada
Palette renforcée



Heavy duty
Extra resistente
Extra résistant



REF	Color	cm	L cm	
4808820		21 x 7,5	42	12

4808920 Perforated Turner with
Espátula perforada reforzada
Palette perforée renforcée



REF	Color	cm	L cm	
4808920		21 x 7,5	42	12

5284120 Slotted reinforced nylon turner
Espátula nylon reforzada
Spatule renforcée à nylon



One-piece construction
Construcción de una sola pieza
Construction monobloc

Heavy duty
Extra resistente
Extra résistant



REF	Color	L cm	
5284120		34,5	12

P385 Baker spatula
Espátula pastelera
Palette



ABS Handle
Mango ABS
Man



REF	Peel / Pala / Pelle cm	L cm	
P385020	20,5	34,0	72
P385026	26	39,0	72
P385030	30	43,5	72

Kitchen utensils 5.1

Utensilios de cocina
Ustensiles de cuisine

P381 Cleaning spatula
Espátula triangular "pintor"
Palette triangle



ABS Handle
Mango ABS
Manche en ABS



REF	cm	L cm	
P381008	8	24,5	120
P381010	10	25,0	120

P382 Spatula
Pala bar
Palette



ABS Handle
Mango ABS
Manche en ABS



REF	cm	L cm	
P382000	7 x 16	29	144

P383 Fast-food and fish turner
Pala fast-food y pescado
Palette fast-food et poisson



ABS Handle
Mango ABS
Manche en ABS

Flexibel
Flexible



REF	cm	L cm	
P383000	7,3 x 25	38	144

P384 Perforated fast-food turner
Pala fast-food perforada
Palette fast-food perforée



ABS Handle
Mango ABS
Manche en ABS

Flexibel
Flexible



REF	cm	L cm	
P384000	7,3 x 25	38	144

P386 Dough scraper
Rasqueta
Raclette



ABS Handle
Mango ABS
Manche en ABS



REF	cm	
P386000	15 x 7,5	144

P380 Pizza wheel
Ruleta cortapizzas
Roulette à pizza



ABS Handle
Mango ABS
Manche en ABS



REF	cm	L cm	
P380000	10	23,5	12

5.1 Kitchen utensils

Utensilios de cocina
Ustensiles de cuisine

P3855 Butter spreader Espátula para untar Couteau à beurre



REF	Peel / Pala / Pelle cm	L cm	
P385500	10,4 x 3,4	23	144

P872 Cake server Pala pasteles Pelle à gâteau



Without saw
Sin sierra
Sans scie

REF	L cm	
P872000	28	144

P37501 Triangle dough scraper. Wood handle Rasqueta triangular. Mango madera Raclette triangle. Manche en bois



REF	Peel / Pala / Pelle cm	L cm	
P375010	10,2 x 10	21	144

P37506 Spatula. Wood handle Pala bar. Mango madera Palette. Manche en bois



REF	Peel / Pala / Pelle cm	L cm	
P375061	15,2 x 7,6	29	144

P37507 Rectangular dough scraper. Wood handle Rasqueta rectangular. Mango madera Raclette rectang. Manche en bois



REF	Peel / Pala / Pelle cm	L cm	
P375070	15,2 x 7,6	11,3	144

P37511 Butter spreader. Wood handle Espátula para untar. Mango madera Couteau à beurre. Manche en bois



REF	Peel / Pala / Pelle cm	L cm	
P375110	10,2 x 3,3	19,7	144

Kitchen utensils 5.1

Utensilios de cocina
Ustensiles de cuisine

P374 St/Steel double mesh strainer Colador doble malla en acero inoxidable Passoire double maille en acier inox

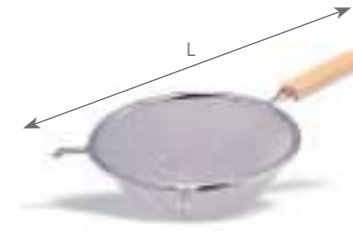

Mesh size
Luz de malla
Maillage
mm

REF	Ø cm	L cm	Mesh size Luz de malla Maillage mm	
P374013	13	30,0	1-3	72
P374015	15	32,0	1-3	72
P374018	18	34,0	1-3	72
P374020	20	38,0	1-3	72
P374026	26	58,5	1,6-3	72

P324 St/Steel reinforced 1/2 ball colander Colador 1/2 bola reforzado en acero inox Passoire ronde renforcé en acier inox

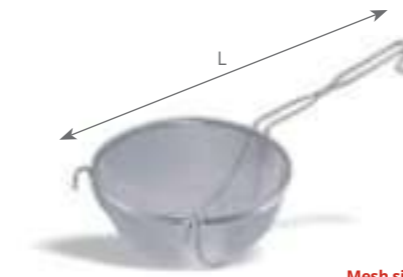

Mesh size
Luz de malla
Maillage
mm

REF	Ø cm	L cm	Mesh size Luz de malla Maillage mm	
P324013	13	36,0	0,530	36
P324016	16	40,0	0,530	36
P324019	19	42,5	0,530	36
P324022	22	49,0	0,530	36
P324025	25	55,5	0,530	36

P325 St/Steel hemispherical strainer Colador media bola en acero inox Passoire demi-sphérique en acier inox



Mesh size
Luz de malla
Maillage
mm

REF	Ø cm	L cm	Mesh size Luz de malla Maillage mm	
P325008	8	22,5	0,700	96
P325010	10	25,2	0,700	96
P325012	12	32,5	0,700	96
P325015	15	40,2	0,700	72
P325018	18	42,5	0,700	72
P325020	20	44,5	0,700	72

P375 St/Steel double mesh strainer. Reinforced Colador doble malla en acero inoxidable. Reforzado Passoire double maille en acier inox. Renforcé



Mesh size
Luz de malla
Maillage
mm

REF	Ø cm	L cm	Mesh size Luz de malla Maillage mm	
P375030	30	79,0	1,040	12
P375035	35	86,5	1,040	12

P348 St/Steel conical strainer Colador cónico en acero inoxidable Passoire conique en acier inox



Mesh size
Luz de malla
Maillage
mm

REF	Ø cm	L cm	Mesh size Luz de malla Maillage mm	
P348008	8	22,5	0,700	96
P348010	10	24,5	0,700	96
P348012	12	31,5	0,700	96
P348015	15	35,0	0,700	96
P348018	18	40,5	0,700	72

P373 Cotton strainer Colador bayeta Passe-bouillon



REF	L cm	
P373020	21,5	1
P373024	26,0	1
P373028	29,0	1

5.1 Kitchen utensils

Utensilios de cocina
Ustensiles de cuisine



P303 Conical colander Colador chino Chinois



REF	Ø cm	H cm	
P303016	17,2	15,9	24
P303018	18,6	17,9	24
P303020	21,1	20,6	24
P303022	23,2	23,0	24
P303024	25,1	25,2	24
P303026	27,2	28,1	24

P347 Conical colander with wire gauze Colador chino con malla Chinois à gaze



REF	Ø cm	Mesh size Luz de malla Maillage mm	
P347020	20	0,700	12
P347024	24	0,700	12

P970 Stand for chinese colander or funnel Soporte para chino o embudo Support pour chinois ou entonnoir



REF	Ø cm	H cm	
P970000	16	19	18

P3032 Triangle Triángulo Triangle



Equilateral triangle
Triángulo equilátero
Triangle équilatéral

REF	L cm	
P303200	29	24

See products on / Ver productos en / Voir produits en page

P. 162

Confectionery funnel Embudo dosificador Entonnoir doseur



Kitchen utensils 5.1

Utensilios de cocina
Ustensiles de cuisine

P308 Conical colander Escurridera Passoire conique



Heavy duty
Extra resistente
Extra résistant



REF	Ø cm	H cm	
P308030	30	16,0	1
P308035	35	16,5	1
P308040	40	18,0	1
P308045	45	19,5	1
P308050	50	22,5	1

P109 Conical colander Escurridera con aro Passoire conique



REF	Ø cm	H cm	
P109035	35	16,5	1
P109040	40	17,5	1
P109045	45	20,0	1
P109050	50	22,5	1

P300 St/steel colander with stand Escurridera inox con base Passoire inox sur pied



REF	Ø cm	H cm	
P300024	24	11,50	48
P300030	30	13,50	24

P3003 Mesh conical colander Escurridera de malla Passoire à maille



REF	Ø cm	H cm	
P300325	25	12	1
P300335	35	18	6
P300340	40	18	6

5.1 Kitchen utensils

Utensilios de cocina
Ustensiles de cuisine

SS
Stainless
steel

P313 Vegetable sieve Pasapurés Moulin à légumes



With 2 St/Steel interchangeable cutters
Con 2 discos inox. intercambiables
Avec 2 coupeurs inox interchangeables

REF	Ø cm	Ø cm Filter / Filtro / Filtre	
P313025	25	11,5	1
P313030	30	14,5	16

P945 Flour bin Harinero Tamis à farine



REF	W x D x H cm	
P945037	37 x 26,5 x 18	4
P945050	50 x 26,5 x 18	3
P945051	50 x 33 x 18	1

P958 St/Steel hook 1p. Gancho acero inoxidable 1p. Crochet inox 1p.



REF	L cm	Ø mm	
P958010	10	4	20
P958012	12	5	20
P958014	14	6	20
P958016	16	6	20
P958018	18	6	20

P3131 Vegetable sieve Pasapurés Moulin à légumes



With 2 St/Steel interchangeable cutters
Con 2 discos inox. intercambiables
Avec 2 coupeurs inox interchangeables

REF	Ø cm	Ø cm Filter / Filtro / Filtre	
P313126	26	16,5	1
P313132	32	16,5	1

P954 Funnel with removable filter Embudo con filtro extraíble Entonnoir avec filtre extractible



REF	Ø A cm	Ø B cm	
P954013	13	2,6	30
P954015	15	2,6	20
P954020	20	3,2	20
P954025	25	3,2	8

Products made of optimal quality stainless steel.
Precision and easy handling.

Productos fabricados en acero inoxidable de óptima
calidad. Precisión y fácil manejo.

Produits en acier inoxydable de qualité. Précision et
manipulation facile.

Kitchen utensils 5.1

Utensilios de cocina
Ustensiles de cuisine



P870 Round egg ring Molde huevo sandwich redondo Moule à oeuf rond

SS
Stainless
steel



REF	Ø cm	H cm	
P870000	8,5	11,0	300

P871 Squared egg mould Molde huevo sandwich cuadrado Moule à oeuf carré

SS
Stainless
steel



REF	W x D x H cm	
P871000	8,5 x 8,5 x 11	300

P905 Solid St/Steel meat beater Aplastacarnes inox forjado Aplatisseur inox forgé

SS
Stainless
steel



REF	Ø cm	Kg	L cm	
P905015	10	1,5	14	10

P942 / P943 Meat tenderizer Aplastadora carne Aplatisseur à viande

SS
Stainless
steel



REF	Ø cm	Kg	L cm	
P942000	9,5	0,750	28,5	20
P943000	9,5	0,750	28,5	20

Graters selection guide

Guía selección ralladores

Guide sélection rapés

	RIBON DOBLE NAVAJA TRANCHANTS	LARGE SHAVER TIRAS LARGAS LARGE COUPE	FINE FINO FIN	MEDIUM MEDIO MOYEN	EXTRA COARSE GRUESO GROS GRAINS	DUAL DUAL DOUBLE
Carrot Zanahoria Carotte	✓	✓				✓
Onion Cebolla Oignon	✓			✓		✓
Garlic Ajo Ail			✓			
Chocolate	✓		✓	✓	✓	✓
Citrus Cítricos Citron		✓	✓	✓		
Potato Patata Pomme de Terre	✓	✓				
Apple Manzana Pomme	✓	✓			✓	
Hard Cheese Queso duro Fromage	✓		✓	✓	✓	✓
Soft Cheese Queso blando Fromage	✓				✓	
Nut Nuez Noix			✓	✓		✓
Pepper Pimiento Poivron			✓	✓		✓
Tomato Tomate Tomato				✓	✓	

P328 Grater

Rallador

Râpe



P328600

REF	Sides / Caras / Faces	W x D x H cm	
P328020	4	9 x 6,5 x 20,8	144
P328023	4	10,5 x 8 x 23,3	72
P328600	6	14,5 x 11 x 22	72

P391 St/Steel nutmeg grater

Rallador nuez moscada de acero inox

Râpe à muscade en acier inox



REF	
P391000	50

Kitchen utensils 5.1

Utensilios de cocina
Ustensiles de cuisine



P3221 St/Steel "slim" grater with handle

Rallador acero inoxidable "slim" con mango

Râpe inoxydable "slim" avec queue



IDEA! Ideal for citrus
Especial cítricos
Idéal pour agrumes



P322104
Fine
Fino
Fin



P322103
Medium
Medio
Moyen



P322101
Dual
Dual
Double



P322102
Ribon
Doble navaja
Tranchants

REF	cm	
P322101	39,5 x 3,5	48
P322102	39,5 x 3,5	48
P322103	39,5 x 3,5	48
P322104	39,5 x 3,5	48

Ergonomic and soft touch handles. Non-slip rubber end / Mangos ergonómicos. Borde antideslizante / Poignée ergonomique. Extrémité anti-dérapant

P3222 St/Steel "wide" grater with handle

Rallador acero inoxidable "wide" con mango

Râpe inoxydable "wide" avec queue



IDEA! Ideal for citrus
Especial cítricos
Idéal pour agrumes



P322204
Fine
Fino
Fin



P322202
Ribon
Doble navaja
Tranchants



P322201
Large shaver
Tiras largas
Large coupe



P322203
Extra coarse
Grueso
Gros grains

REF	cm	
P322201	31,5 x 7,3	48
P322202	31,5 x 7,3	48
P322203	31,5 x 7,3	48
P322204	31,5 x 7,3	48

5.1 Kitchen utensils

Utensilios de cocina
Ustensiles de cuisine

P868 Squeeze dispenser Dispensador a presión Distributeur à pression

PE
Polyethylene

BEST SELLER



REF	Color	ml	H cm	Ø cm	Box
P868001	Red	240	18,0	5	108
P868002	Red	360	21,0	5	72
P868003	Red	720	24,5	5	36
P868004	Yellow	240	18,0	5	108
P868005	Yellow	360	21,0	5	72
P868006	Yellow	720	24,5	5	36
P868007*	Clear	240	18,0	5	108
P868008*	Clear	360	21,0	5	72
P868009*	Clear	720	24,5	5	36

2808-13 Squeeze dispenser Dispensador a presión Distributeur à pression

PE
Polyethylene

Clear
Transparente
Transparent



Ref	Color	ml	H cm	Ø cm	Box
2808-13	Clear	240	18,4	5,0	12
2812-13	Clear	350	18,4	6,0	12
4916-13	Clear	470	18,7	7,5	12
4924-13	Clear	710	26,0	7,3	12
4932-13	Clear	950	26,4	8,3	12

IDEA! Ideal for dish presentation
Ideal para decoración
Idéal pour décoration

2208-13 Twin squeeze dispenser Dispensador a presión doble Distributeur à pression double

PE
Polyethylene

NEW!



REF	Color	ml	H cm	Ø cm	Box
2208-13	Clear	240	18,4	5,1	12
2212-13	Clear	350	18,4	6,0	12
2224-13	Clear	710	24,8	7,5	12

3316-13 Tri squeeze dispenser Dispensador a presión triple Distributeur à pression triple

PE
Polyethylene

NEW!



REF	Color	ml	H cm	Ø cm	Box
3316-13	Clear	470	18,7	7,5	12
3324-13	Clear	710	24,8	7,5	12
3332-13	Clear	950	25,4	8,6	12

Bottle color
Color de la botella
Couleur de la bouteille

01	44	02	54
08	191	13	

Top color
Colores del tapón
Couleurs de bouchon

01	44	02	54
08	191	13	

For more color combinations, contact your sales representative
Para más combinaciones de colores, contacte con su área manager
Pour plusieurs combinaisons de couleurs, contactez votre commercial de la zone

Kitchen utensils 5.1

Utensilios de cocina
Ustensiles de cuisine

2908 Squeeze dispenser with open-close system cap Dispensador a presión con tapón cierre rosca Distributeur pressurisation a/capuchon d'ouverture-fermeture

PE
Polyethylene

Clear
Transparente
Transparent



REF	ml	H cm	Ø cm	Box
2908-13	240	18,4	5,1	12
2912-13	350	18,4	6,0	12
5324-13	710	24,4	7,3	12

26120 Squeeze dispenser with cap Dispensador a presión con tapón Distributeur pression avec capuchon

PE
Polyethylene

Clear
Transparente
Transparent



REF	ml	H cm	Ø cm	Box
26120-13	350	16,2	6,2	12
26240-13	710	22,5	7,5	12
26320-13	950	22,9	8,6	12

4961 Dredgers Especieros Saupoudreuses

PE
Polyethylene

Clear
Transparente
Transparent

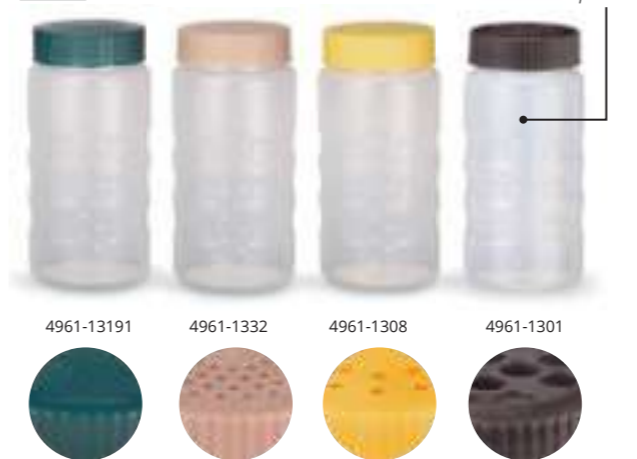

REF	ml	Ø cm Holes / Agujeros / Troues	Ø cm	H cm	Box
4961-13191	470	0,14	7,3	16	12
4961-1332	470	0,25	7,3	16	12
4961-1308	470	0,46	7,3	16	12
4961-1301	470	0,94	7,3	16	12

P946 Dredgers Especieros Saupoudreuses

SS
Stainless steel



Dredger "A" with mesh
Especiero "A" con malla
Saupoudreuse "A" maillée

With plastic cover
Con tapón de plástico
Avec couvercle en plastique

REF	Ø cm Holes / Agujeros / Troues	H cm	Ø cm	Box
A P946001	-	9,6	7	144
B P946002	0,2	9,6	7	144
C P946003	0,3	9,6	7	144
D P946004	0,4	9,6	7	144

5.1 Kitchen utensils

Utensilios de cocina
Ustensiles de cuisine

P334 Oil pourer
Alcuza
Huilière



REF	Lts	
P334050	0,50	20
P334100	1,00	20

P873 Aluminium check minder
Barra de notas de aluminio
Barre porte-bons en aluminium



REF	L cm	H cm	
P873045	45	5,0	48
P873060	60	5,0	48
P873090	90	5,0	48

P8180 Metallic brush
Cepillo metálico
Brosse métallique



Ideal for ovens, grills and barbecues
Ideal para hornos, brasa y barbacoa
Idéal pour fours, grill et barbecue

REF	L cm	
P818000	27	1

P94009 St/Steel mixing paddle
Remo acero inoxidable
Spatule géante inoxydable



REF	Peel / Pala / Pelle cm	L cm	
P940090	12 x 19	90	12
P940120	12 x 19,5	120	12

P940 Grill scraper aluminium
Rascador con mango aluminio
Raclette à plancha



REF	cm	
P940000	44,5 x 12 x 12,7	6
RE940001	12,7 x 7,7	24

P944 Fish scaler
Escamador
Ecailleur



REF	L cm	
P944000	23,5	1

REDCO® pujadas®
A VOLLRATH COMPANY

WIDE RANGE OF MANUAL FOOD PROCESSORS

Cuts both fruit and vegetables
Speed up your work 11 times faster than hand cutting
Easy-to-remove interchangeable blades
Easy to clean

AMPLIA GAMA DE PROCESADORES DE ALIMENTOS MANUALES

Corta verduras y frutas
Hasta 11 veces más rápido que el corte a mano
Fácil intercambio de las cuchillas
Limpieza rápida y fácil

LARGE GAMME D'APPAREILS MANUELS DE TRANSFORMATION DES ALIMENTS

Coupe les légumes et les fruits
Jusqu'à 11 fois plus rapide que lorsque vous coupez à la main
Couteaux facilement interchangeables
Nettoyage rapide et facile



DICE & STICKS
DADOS Y BASTONCILLOS
CUBES ET BÂTONNETS



SLICE
REBANADA
TRANCHES



WEDGE
GAJOS
QUARTIERS



CORE
SACACORAZONES
ÉVIDOIR



Which manual food processors do you need?

¿Qué procesador manual de alimentos necesitas?

Quel appareil manuel de transformation des aliments vous faut-il ?



UTENSILIOS
UTENSILS
USTENSILES

TIME SAVING
Faster than cutting by hand.
AHORRO TIEMPO
Veces más rápido que cortar a mano.
GAIN DE TEMPS
Fois plus rapide qu'une coupe à la main.

	3x	3x	5x	1x	2,5x	3x	3x	5x
Lemons Limonas Citrons								
Limes Limas Citrons verts								
Oranges Naranjas Oranges								
Tomatoes Tomates Tomates	✓	✓				✓	✓	✓
Onions Cebollas Oignons	✓	✓	✓		✓			
Celery Apio Céleri	✓	✓						
Peppers Pimientos Poivrons	✓	✓						
Potatoes Patatas Pommes de terre	✓	✓			✓	✓	✓	
Apples Manzanas Pommes	✓ 4x	✓ 4x				✓	✓	
Pears Peras Poires	✓ 4x	✓ 4x				✓	✓	
Lettuce Lechuga Laitue			✓	✓				
Bell peppers Pimientos Poivrons	✓		✓					
Cucumbers Pepino Concombres			✓					

UTENSILIOS
UTENSILS
USTENSILES



SS
Stainless
steel

AI
Aluminium

Manual food processors 5.2

Procesadores manuales de alimentos
Appareils manuels de transformation des aliments

55457 Big size tabletop dicer & slicer Cortador-Rebanador de sobremesa grande Grand Coupe légumes en tranches et cubes

NSF

InstaCut™ 5.0
Tabletop
Sobremesa
À poser

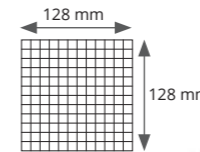

**BEST
SELLER**

Adjustable to
Adaptable a
Adaptable à

Inside / Dentro / Dans
1/3 100 mm
1/4 150 mm
1/6 150 mm

Outside / Fuera /
Extérieur (max)
1/1 200 mm

H cm*

28,2 cm

18 cm
25,4 cm

With suction base.
Con ventosas de agarre en la base.
Avec ventouse d'accrochement à la base.

REF	Type / Tipo	Cut / Corte / Coupe mm	
DICE & STICKS / DADOS - BASTONCILLOS / CUBES ET BÂTONNETS			
55457		6,4 ●	1
55458		9,5	1
55459		12,7	1
SLICE / REBANADA / TRANCHES			
55460		6,4 ●	1

Items marked with the same coloured dot are compatible with each other
Los artículos marcados con cada punto de color son compatibles entre ellos
Les articles marqués d'un point de couleur sont compatibles



*H 50,8 cm Open / Abierto / Ouvert
*H 47 cm Closed / Cerrado / Fermé

3X Faster / Más rápido



4X Faster / Más rápido



T-handle, pusher block and blade
Asa en T, bloque de empuje y cuchilla
Poignée en T, bloc de poussée et lame

TIPO/TIPO

REF mm

DICE & STICKS / DADOS - BASTONCILLOS / CUBES ET BÂTONNETS



● 55483 6,4
55484 9,5
55485 12,7

SLICE / REBANADA / TRANCHES

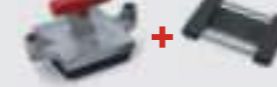

● 55486 6,4

SECTION / SECCIONES / QUARTIERS

WEDGE / GAJOS / QUARTIERS



● 55490 6
55491 8
55492 10
● 55493 12

CORE / SACACORAZONES / ÉVIDOIR



● 55494 6

Replacement blade only
Sólo cuchilla de reemplazo
Lame de rechange seule

REF



● 55470
55471
● 55472



● 55473



● 55477
55478
55479
● 55480



● 55481
55482

5.2 Manual food processors

Procesadores manuales de alimentos
Appareils manuels de transformation des aliments



15000 Small size tabletop dicer & slicer

Cortador-Rebanador de sobremesa pequeño
Coupe légumes en tranches et cubes de table

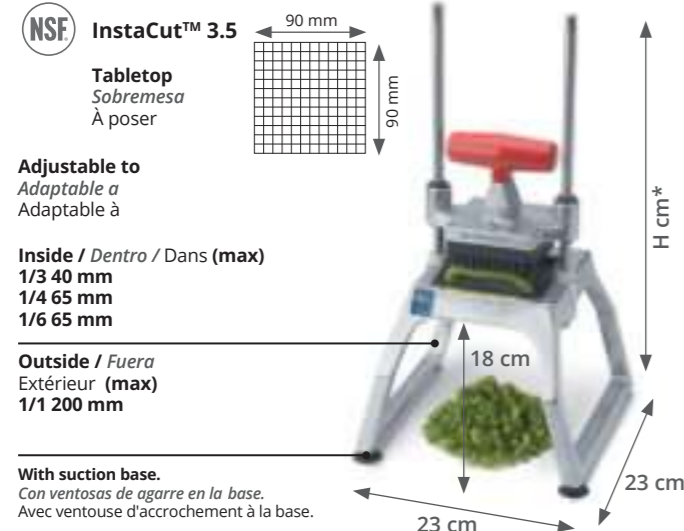

REF	Type / Tipo	Cut / Corte / Coupe mm	
DICE & STICKS / DADOS - BASTONCILLOS / CUBES ET BÂTONNETS			
15000		6,4	1
15001		9,5	1
15002		12,7	1

REF	Type / Tipo	Section / Secciones / Quartiers	
WEDGE / GAJOS / QUARTIERS			
15005		6	1
15006		8	1
15007		10	1

*H 45,7 cm Open / Abierto / Ouvert
*H 43,5 cm Closed / Cerrado / Fermé



15016 Wall mount dicer & slicer

Cortador-Rebanador de pared
Coupe légumes fixation murale



REF	Type / Tipo	Cut / Corte / Coupe mm	
DICE & STICKS / DADOS - BASTONCILLOS / CUBES ET BÂTONNETS			
15016		6,4	1
15017		9,5	1

Replacement blade only

Sólo cuchilla de reemplazo
Lame de rechange seule

REF	
15062	
15063	
15064	
15086	
15065	
15067	
15068	
15069	
15070	
15072	

T-handle, pusher block and blade / Asa en T, bloque de empuje y cuchilla

Poignée en T, bloc de poussée et lame

Ref. 15000 - 15010			Ref. 15016 - 15024		
TYPE / TIPO	REF	mm	REF		
DICE & STICKS / DADOS - BASTONCILLOS / CUBES ET BÂTONNETS					
	15059	6,4	15081		
	15060	9,5	15082		
	15061	12,7	15083		
	15085	6,4 x 12,7	-		
Section / Secciones / Quartiers					
WEDGE / GAJOS / QUARTIERS					
	15050	4	15073		
	15052	6	-		
	15053	8	15076		
	15054	10	-		
	15055	12	15078		
CORE / SACACORAZONES / ÉVIDOIR					
	15058	8			

Manual food processors 5.2

Procesadores manuales de alimentos
Appareils manuels de transformation des aliments



47713 Potato cutter

Cortador de patatas
Coupe-pommes de terre

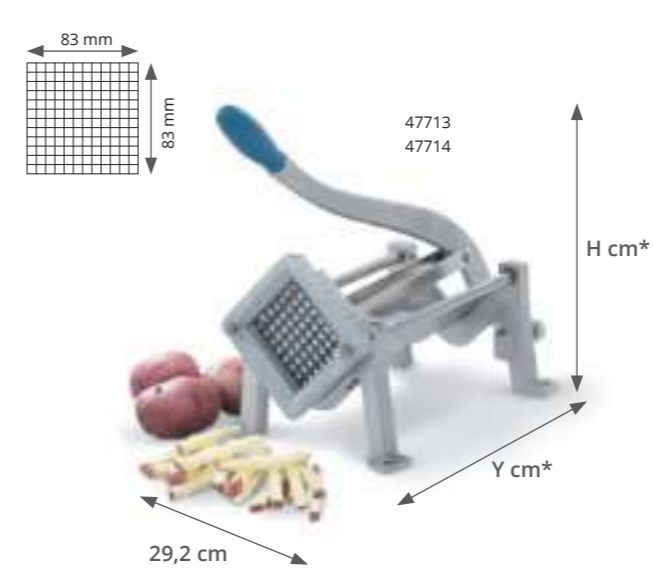

REF	Type / Tipo	Cut / Corte / Coupe mm	
DICE & STICKS / DADOS - BASTONCILLOS / CUBES ET BÂTONNETS			
47713		9,5	1
47714		11,0	1
47715		7,0	1 NEW

REF	Type / Tipo	Section / Secciones / Quartiers	
WEDGE / GAJOS / QUARTIERS			
47703		8,0	1 NEW

*Y 87,6 cm H 58,4 cm Open / Abierto / Ouvert
*Y 45,0 cm H 35,6 cm Closed / Cerrado / Fermé



REF	Type / Tipo	Cut / Corte / Coupe mm	
DICE & STICKS / DADOS - BASTONCILLOS / CUBES ET BÂTONNETS			
45749-1		9,5	1
45750-1		11,0	1
45751-1		7,0	1
SECTION / SECCIONES / QUARTIERS			
45603-1		8	1

Screw holes on base of legs for permanent mounting to table or wall.
Agujeros para tornillos en la base de las patas para el montaje permanente en mesas o paredes.
Trous à vis sur la base des pieds pour fixation permanente sur une table ou un mur.

P975 French fry cutter

Cortador de patatas fritas
Coupe frites

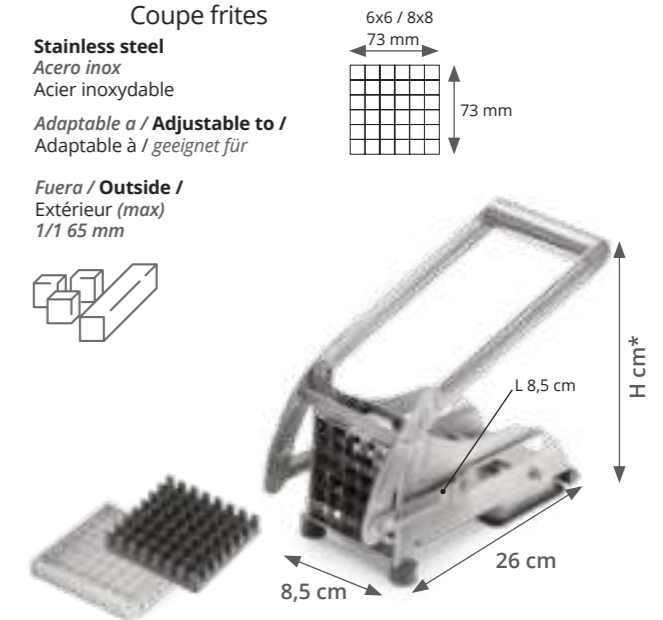

Stainless steel
Acero inox
Acier inoxydable

Adaptable a / Adjustable to /
Adaptable à / geeignet für

Fuera / Outside /
Extérieur (max)
1/1 65 mm

REF	Cut / Corte / Coupe mm	Holes / Agujeros / Trous	
P975000	12 / 9	36 / 64	1

*H 30 cm Open / Abierto / Ouvert
*H 13 cm Closed / Cerrado / Fermé

REF	Cut / Corte / Coupe mm	Holes / Agujeros / Trous	
RE975001	12	36 (6 x 6)	1
RE975002	9	64 (8 x 8)	1

5.2 Manual food processors

Procesadores manuales de alimentos
Appareils manuels de transformation des aliments



400N Salad cutter
Cortador de lechuga
Coupe-Salade

LETTUCE KING® I



Adjustable to
Adaptable a
Adaptable à
(max)
1/1 100 mm
1/2 150 mm

REF	Type / Tipo	Cut / Corte / Coupe mm	Holes / Agujeros / Troux	
400N		4,8	37	1
402NC		9,5	19	1
401N		19,0	10	1 NEW

*Y 48,3 cm H 45,7 cm Open / Abierto / Ouvert
*Y 59,1 cm H 43,5 cm Closed / Cerrado / Fermé

Blade assembly
Conjunto de cuchillas
Jeu de lames

REF	For / Para / Pour	Cut / Corte / Coupe mm	Blades / Cuchillas Lames	
DICE & STICKS / DADOS - BASTONCILLOS / CUBES ET BÂTONNETS				
435	400N	4,8	37	1
484C	402NC	9,5	19	1
434	401N	19,0	10	1

Cut a quarter head of lettuce at a time.
Corte un cuarto de cabeza de lechuga a la vez.
Coupez un quart de tête de laitue à la fois.

5X Faster / Más rápido

4400N Salad cutter
Cortador de lechuga
Coupe-Salade

LETTUCE KING® IV

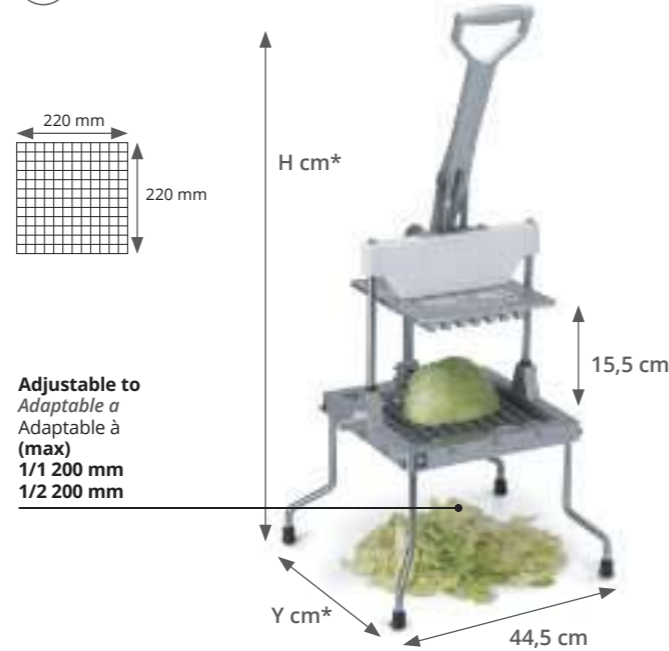

Adjustable to
Adaptable a
Adaptable à
(max)
1/1 200 mm
1/2 200 mm

REF	Type / Tipo	Cut / Corte / Coupe mm	
DICE & STICKS / DADOS - BASTONCILLOS / CUBES ET BÂTONNETS			
4400N		25,4 x 25,4	1

*Y 43,2 cm H 81,3 cm Open / Abierto / Ouvert
*Y 47 cm H 54,9 cm Closed / Cerrado / Fermé

Blade assembly
Conjunto de cuchillas
Jeu de lames

REF	Type / Tipo	Cut / Corte / Coupe mm	
DICE & STICKS / DADOS - BASTONCILLOS / CUBES ET BÂTONNETS			
4408		25,4 x 25,4	1

Does not bruise the lettuce.
No oscurece la lechuga.
N'abîme pas la laitue.

5X Faster / Más rápido



Manual food processors 5.2

Procesadores manuales de alimentos
Appareils manuels de transformation des aliments

403NH Fruit & vegetable slicer
Rebanadora de frutas y verduras
Coup-fruit et légumes



Adjustable to
Adaptable a
Adaptable à
(max)
1/2 65 mm

REF	Type / Tipo	Cut / Corte / Coupe mm	Blades / Cuchillas Lames	
CORE / SACACORAZONES / ÉVIDOIR				
403NH		6,4	28	1

*Y 33,6 cm H 50,8 cm Open / Abierto / Ouvert
*Y 55,7 cm H 23,3 cm Closed / Cerrado / Fermé

Replacement blade only
Solo cuchilla de reemplazo
Lame de rechange seule

REF	Type / Tipo	Cut / Corte / Coupe mm	Blades / Cuchillas Lames	
CORE / SACACORAZONES / ÉVIDOIR				
485		6,4	28	1

Full 12.7 cm cutting area optimal for large fruits.
Área de corte completa de 12,7 cm para frutas grandes.
Longueur de coupe de 13 cm optimale pour les fruits volumineux.

Prevents bruising of fruit during cutting, reducing food waste.
No oscurece la fruta durante el corte, reduciendo así los desechos.
N'abîme pas le fruit durant la coupe, réduisant le gaspillage.

15604 Bloom onion cutter
Cortador cebollas en flor
Coupe onion en fleur



500N Onion cutter
Cortador de cebollas
Coupe-onions

ONION KING®



Adjustable to
Adaptable a
Adaptable à
(max)
1/1 65 mm
1/2 65 mm
1/3 100 mm
1/4 100 mm
1/6 100 mm

REF	Type / Tipo	Cut / Corte / Coupe mm	Blades / Cuchillas Lames	
CORE / SACACORAZONES / ÉVIDOIR				
500N		4,8	13	1
501N		6,4	11	1

*H 49 cm Open / Abierto / Ouvert
*H 39,4 cm Closed / Cerrado / Fermé

Blade assembly
Conjunto de cuchillas
Jeu de lames

REF	FOR / PARA / POUR	Cut / Corte / Coupe mm	Blades / Cuchillas Lames	
509	500N	4,8	13	1
511	501N	6,4	11	1

Exact slice thickness / Espesor de rebanada exacto / Épaisseur de tranches exacte

2,5X Faster / Más rápido



INSTABLOOM® II

REF	Section / Secciones / Quartiers	
15604	24	1

*H 76,2 cm Open / Abierto / Ouvert
*H 48,3 cm Closed / Cerrado / Fermé

Blade assembly
Conjunto de cuchillas
Jeu de lames

REF	Section / Secciones / Quartiers	
15601	24	1

Constructed from heavy duty cast aluminum.
Fabricación de aluminio moldeado altamente resistente.
En aluminium coulé ultra-robuste.

Features precision edged stainless steel blades.
Tiene cuchillas de acero inoxidable con bordes de precisión.
Lames inox de précision.

With suction cup base.
Con ventosas de agarre en la base.
Avec ventouse d'accrochement à la base.



15601

5.2 Manual food processors

Procesadores manuales de alimentos
Appareils manuels de transformation des aliments

606N Tomato and lemon wedger
Cortador seccionador de tomates y cítricos
Diviseur à tomates et agrumes



WEDGEMASTER™

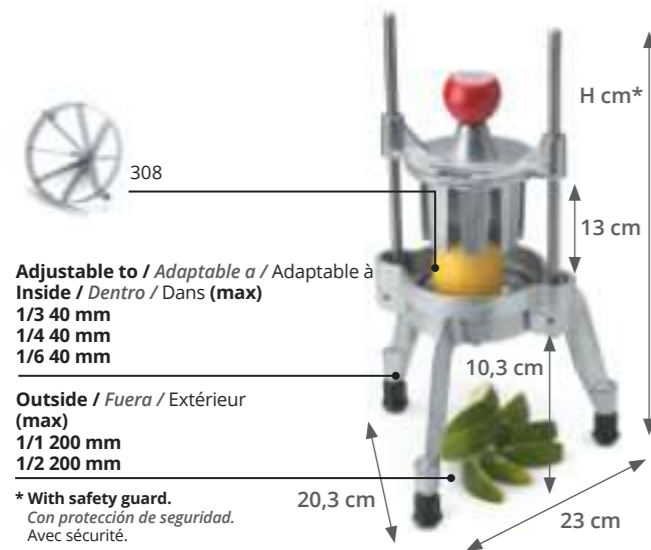

REF	Section / Secciones / Quartiers	Ships with blades Se vende con cuchillas Description de la coupe	
606N	6	306/336	1
808N	8	308/338	1

REF	Type / Tipo	Section / Secciones / Quartiers	
Blade assembly Conjunto de cuchillas Jeu de lames			
WEDGE / GAJOS / QUARTIERS			
306		6	1
308		8	1

*H 40,6 cm Open / Abierto / Ouvert
*H 40,3 cm Closed / Cerrado / Fermé

3X Faster / Más rápido



700-1 Tomato and lemon wedger
Cortador seccionador de tomates y cítricos
Diviseur à tomates et agrumes



WEDGEMASTER™ II

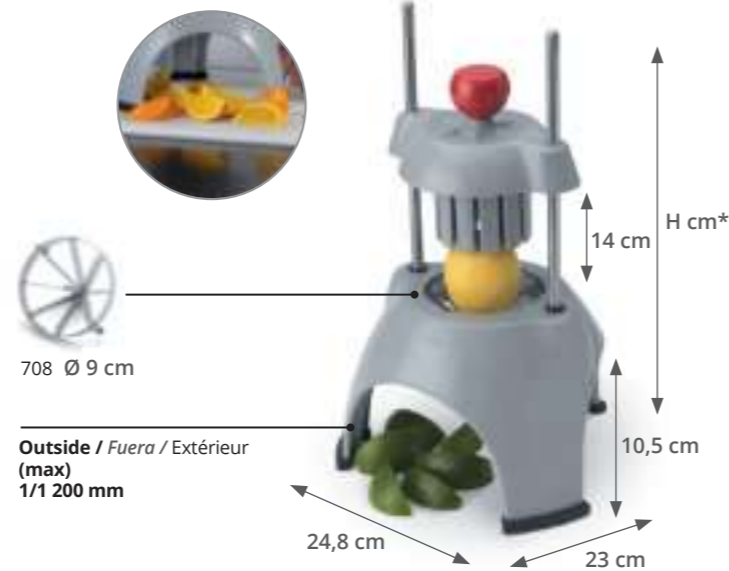

REF	Section / Secciones / Quartiers	
700-1	6	1
700-4	8	1

REF	Type / Tipo	Section / Secciones / Quartiers	
Blade assembly Conjunto de cuchillas Jeu de lames			
WEDGE / GAJOS / QUARTIERS			
704		4	1
706		6	1
708		8	1
712		12	1

*H 40,6 cm Open / Abierto / Ouvert
*H 38,7 cm Closed / Cerrado / Fermé
Constructed of dishwasher safe polycarbonate material.
Fabricación de material de policarbonato para lavavajillas.
En polycarbonate qui passe au lave-vaisselle.

Compatible



3X Faster / Más rápido



Manual food processors 5.2

Procesadores manuales de alimentos
Appareils manuels de transformation des aliments

P937 Versatil machine
Máquina multi-usos
Machine universel



REF	H cm	
P937000	80	1

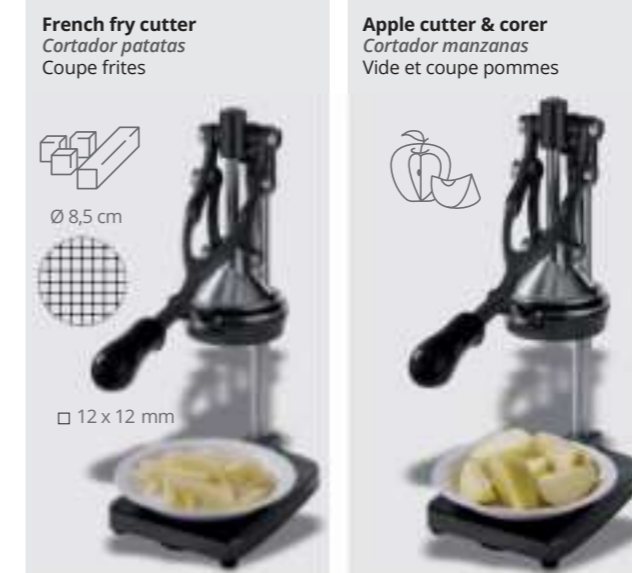

REF	H cm	
RE937001	French fry cutter spare part Recambio cortador patatas Coupe frites (pièce rechange)	1
RE937002	Apple cutter spare part Recambio cortador manzanas Coupe pommes (pièce rechange)	1
RE937003	Juicer spare part Recambio exprimidor zumos Press fruits (pièce rechange)	1

1811 Cube cutter
Cortador en cubos
Coupe en cubes



CUBEKING™

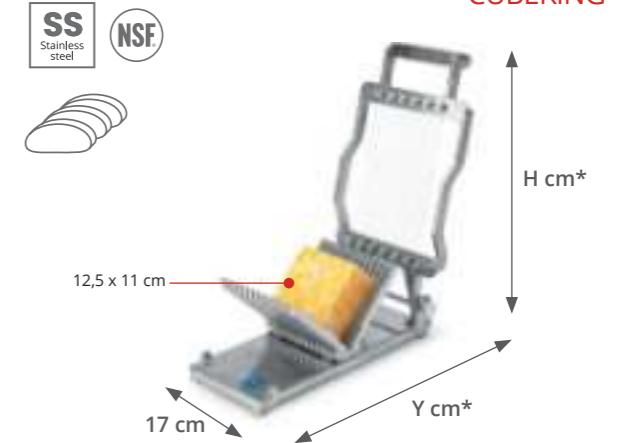

REF	Cut / Corte / Coupe mm	
1811	19,1	1
1812	9,5	1

*Y 33 cm *H 34 cm Open / Abierto / Ouvert
*Y 32 cm *H 11 cm Closed / Cerrado / Fermé

Replacement wire kit
Juego de alambres de repuesto
Kit de fil de rechange

REF	
1823	1

Produce uniform cheese cubes, sticks, and square or rectangular blocks.
Produce cubos, palillos y bloques cuadrados o rectangulares de queso.
Produisez des dés, bâtonnets et blocs carrés ou rectangulaires de fromage.



Manual food processors 5.2

Procesadores manuales de alimentos
Appareils manuels de transformation des aliments

P9759 Tomatoes slicer Cortador de tomates Coupe tomates



REF	Cut / Corte / Coupe mm	cm	Box
P975900	6,4	39 x 21,5 x 20	1
RE975901	6,4	25 x 6,8	12



RE975901
Blade / Cuchilla / Lame

5X Faster
Más rápido



0644N Tomatoes slicer Cortador de tomates Coupe tomates



REF	Cut / Corte / Coupe mm	Blades / Cuchillas / Lames	Box
0644N**	6,4	11	1

[^]With safety guard.
Con protección de seguridad.
Avec sécurité.

Holds firmly on countertop.
Permite sujeción a la mesa.
Fixation ferme sur la table.

Replacement blade item Cuchilla de reemplazo Lame de recharge

REF	Cut / Corte / Coupe mm	Blades / Cuchillas / Lames	Box
**0654	6,4	11	1

5X Faster
Más rápido



0654



15105 Tomatoes slicer Cortador de tomates Coupe tomates

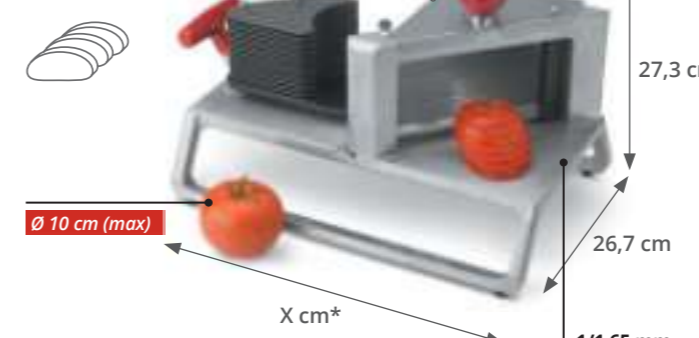

16,5 x 7,5 cm
[^]Scalloped
Festoneada
Festonné

16,5 x 7,5 cm
^{^^}Straight
Recta
Droit

INSTASLICE™

REF	Type / Tipo	Cut / Corte / Coupe mm	Blades / Cuchillas / Lames	Box
15105 [^]		4,8	16	1
15104 [^]		9,5	8	1
15103 [^]		6,4	12	1

*X 44,5 cm Open / Abierto / Ouvert
*X 40,6 cm Closed / Cerrado / Fermé

Replacement blade item Cuchilla de reemplazo Lame de recharge

REF	Type / Tipo	Cut / Corte / Coupe mm	Blades / Cuchillas / Lames	Box
15115 [^]		4,8	16	1
15209 ^{^^}		4,8	16	1
15113 [^]		6,4	12	1
15114 [^]		9,5	8	1

[^]Pop-in pop out^{^^} blade assemblies for easy replacement.
Conjuntos de cuchillas encajables para facilitar el reemplazo.
Lames qui s'installent et se sortent par détente pour un remplacement facile.

5X Faster / Más rápido

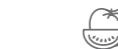

Corrosion resistant.
Resistente a la corrosión.
Résistant à la corrosion.

5.2 Manual food processors

Procesadores manuales de alimentos
Appareils manuels de transformation des aliments

P9640 St/Steel can opener
Abrelatas industrial acero inoxidable
Ouvre-boîtes professionnel en acier inoxydable



55 cm
Maximum height of cans.
Altura máxima de las latas.
Hauteur maximale des boîtes.

REF	H cm	
P964001	60	6

Knife (spare part)
Cuchilla de recambio
Couteau (pièce de rechange)

REF		
RE964100		8

Wheel (spare part)
Rodillo de recambio
Rouleau (pièce de rechange)

REF		
RE964200		1

P390 St/Steel egg slicer
Cortahuevos guitarra de acero inox
Coupe-oeuf en acier inox



REF	cm	
P390000	7,7 x 9,4	120

P3901 2 way egg cutter
Cortahuevos doble uso
Coupe-oeuf 2 utilisations



REF	W x D x H cm	
P390100	11,5 x 9,5 x 3,5	48

P938 Garlic Press
Prensa ajos
Presse-ail



REF		
P938000		24

P610 Apple cutter & corer
Cortador y descorazonador manzanas
Vide et coupe pommes



St/Steel blades with cast aluminium frame
Cuchilla en acero inoxidable y marco en aluminio de fundición
Lames inox et manche en aluminium fonté



REF	Ø cm	
P610000	8,5	24

VOLLRATH

138

pujadas

Manual food processors 5.2

Procesadores manuales de alimentos
Appareils manuels de transformation des aliments

P9755 "V" shaped mandoline slicer
Mandolina corte "V"
"V" mandoline



Includes: 2 julienne blades + 3 thickness guides (1 mm / 2 mm / 3 mm)
Incluye: 2 cuchillas + 3 guías plástico grosor (1 mm / 2 mm / 3 mm)
Comprend: 2 lames julienne + 3 guides épaisseur (1 mm / 2 mm / 3 mm)

Non-slip rubber feet.
Pies goma antideslizantes.
Pieds en caoutchouc antidérapants.

REF	Cut / Corte / Coupe mm	Blades / Cuchillas / Lames	
P975501	4 / 7	24 / 12	8

1400 Tomato corer TOMATO KING®
Descorazonador de tomates
Permet d'ôter le coeur de la tomate



Stainless steel teeth.
Dientes de acero inoxidable.
Dents en inox.

Bulk pack
Paquete a granel
Paquet en vrac

REF		
1400		144

VOLLRATH

P9756 Mandoline
Mandolina
Mandoline



Includes: rotating blades + thickness regulator (3, 6 and 9 mm)
Incluye: cuchilla giratoria + regulador de espesor corte (3, 6 y 9 mm)
Comprend: lames tournantes + régulateur épaisseur (3, 6 et 9 mm)

Slice, wavy slice and sticks.
Rebanada, rebanada ondulada y bastoncillos.
Tranches, ondulé tranches et bâtonnets.

REF	Cut / Corte / Coupe mm	Blades / Cuchillas / Lames	
P975600	4 / 9	23 / 11	8

15149 Sanitary gel lubricant PETROL GEL
Gel lubricante sanitario
Gel lubrifiant sanitaire



REF	ml	
15149	118	1

139

pujadas



Cutting boards 5.3

Tablas de corte
Planches à découper



RAW FISH
PESCADO CRUDO
POISSON CRU



RAW MEAT
CARNE CRUDA
VIANDE CRU



RAW POULTRY & CHIKEN
CARNE CRUDA DE AVE
VIANDE CRU ET VOLAILLES



ALLERGEN-FREE
ANTIALÉRGICO
ANTI ALLERGIQUE



BAKERY & DAIRY
PAN Y LÁCTEOS
PAIN ET PRODUITS LAITIERS



COOKED MEAT
CARNE GUISADA
VIANDE CUISINÉE



FRUIT & VEGETABLES
FRUTA Y VEGETALES
FRUIT ET LÉGUMES



PRESENTACIÓN
PRESENTACIÓN
PRÉSENTATION

We introduce here with the new range of cutting board with more than 20 different patterns and more than 100 references conceived to fulfill all the market needs. We also offer the possibility to produce special sizes and thicknesses upon request. This new range of cutting boards is presented in two different materials, one made of Polyethylene (PE) using the injection technique and the widest range on High Density Polyethylene 500 (HD PE 500) through thermo compression.

Presentamos una nueva gama de tablas de corte con más de 20 modelos distintos y más de 100 referencias, concebidas para satisfacer todas las necesidades del mercado. Ofrecemos también la posibilidad de fabricar medidas y grosores especiales sobre pedido. La nueva gama de tablas de corte se presenta en dos modalidades; unas fabricadas en Polietileno (PE) por inyección y la gama más extensa en Polietileno 500 alta densidad (HD PE 500) por termocompresión.

Nous présentons une nouvelle gamme de planches à découper avec plus de 20 modèles différents et plus de 100 références, conçues pour satisfaire tous les besoins du marché. Nous offrons aussi la possibilité de fabriquer des planques avec des mesures et des épaisseurs spéciales sur commande. Cette nouvelle gamme de planches à découper se présentent en deux matériaux différents: certaines sont produites en Polyéthylène (PE) par injection et la majorité de la gamme est produite en Polyéthylène 500 de haute densité (HD PE 500) par thermo compression.



MAIN FEATURES

The cutting boards made of High Density Polyethylene 500 have higher molecular weight (HMWPE), offering the following properties:

- High DURABILITY
- 25% more resistance to ABRASION
- Higher Fusion temperature: 135,4 °C
- Softening temperature: 83 °C
- Extraordinary RIGIDNESS

* Do not present deformation during the rinsing process of industrial dishwasher cleaning cycle (max. temp. approx. 80 °C).

Following the CE 1935/2004 regulation.

CARACTERÍSTICAS PRINCIPALES

Las tablas de corte fabricadas en Polietileno 500 alta densidad, se caracterizan por un alto peso molecular (HMWPE) ofreciendo:

- Alta DURABILIDAD
- 25% más resistencia a la ABRASIÓN.
- Mayor temperatura de fusión: 135,4 °C.
- Temperatura de reblandecimiento: 83 °C
- Mayor RIGIDEZ

* No presentan deformación durante el aclarado del ciclo de lavado en lavavajillas industriales (temp. máx. aprox. 80 °C).

Conforme a las normativas siguientes: RD 1712/91 registro sanitario de alimentos CE 1935/2004.

CARACTÉRISTIQUES PRINCIPALES

Les planches à découper fabriquées en Polyéthylène 500 haute densité ont un poids moléculaire (HMWPE) plus grand qui offre les suivantes propriétés:

- Longue DURÉE
- 25% plus résistant à l'ABRASION
- Température de fusion: 135,4 °C
- Température de ramollissement: 83 °C
- RIGIDITÉ maximale

* Ne présente pas de déformation lors du cycle lavage dans le lave-vaisselles industriel (Temp. max. approx. 80 °C).

Conforme à la réglementation 1935/2004.

P9118 30 x 20 x 2



With silicon feet
Con pies silicona
Avec pieds en silicone

REF	Color	W x D x H cm	
P911801		30 x 20 x 2	1
P911802		30 x 20 x 2	1
P911803		30 x 20 x 2	1
P911804		30 x 20 x 2	1
P911805		30 x 20 x 2	1
P911806		30 x 20 x 2	1
P911808		30 x 20 x 2	1

P9112



With silicon feet
Con pies silicona
Avec pieds en silicone

REF	Color	W x D x H cm	
P911201		40 x 30 x 2	6
P911202		60 x 40 x 2	3

P9120 40 x 20 x 2



With silicon feet
Con pies silicona
Avec pieds en silicone

REF	Color	W x D x H cm	
P912001		40 x 20 x 2	1

P9113 GN 1/1



With groove With silicon feet
Con ranura Con pies silicona
Avec rigole Avec pieds en silicone

REF	Color	W x D x H cm	
P911301		53 x 32,5 x 2	5
P911302		53 x 32,5 x 2	5
P911303		53 x 32,5 x 2	5
P911304		53 x 32,5 x 2	5
P911305		53 x 32,5 x 2	5
P911306		53 x 32,5 x 2	5

P9117 GN 1/2 320 x 265 x 20



With silicon feet
Con pies silicona
Avec pieds en silicone

REF	Color	W x D x H cm	
P911701		32 x 26,5 x 2	1

P9114 40 x 30 x 2



With silicon feet
Con pies silicona
Avec pieds en silicone

REF	Color	W x D x H cm	
P911401		40 x 30 x 2	1
P911402		40 x 30 x 2	1
P911403		40 x 30 x 2	1
P911404		40 x 30 x 2	1
P911405		40 x 30 x 2	1
P911406		40 x 30 x 2	1
P911408		40 x 30 x 2	1

See products on / Ver productos en / Voir produits en page

P. 198

Stand for GN lids
Soporte para tapas GN
Support pour couvercles GN

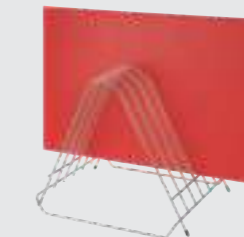

5.3 Cutting boards

Tablas de corte
Planchas à découper

P9119 50 x 30 x 2



With silicon feet
Con pies sílica
Avec pieds en silicone

REF	Color	W x D x H cm	
P911901	White	50 x 30 x 2	1
P911902	Red	50 x 30 x 2	1
P911903	Blue	50 x 30 x 2	1
P911904	Yellow	50 x 30 x 2	1
P911905	Green	50 x 30 x 2	1
P911906	Brown	50 x 30 x 2	1
P911908	Black	50 x 30 x 2	1

P9115 GN 1/1 53 x 32,5 x 2



With silicon feet
Con pies sílica
Avec pieds en silicone

REF	Color	W x D x H cm	
P911501	White	53 x 32,5 x 2	1
P911502	Red	53 x 32,5 x 2	1
P911503	Blue	53 x 32,5 x 2	1
P911504	Yellow	53 x 32,5 x 2	1
P911505	Green	53 x 32,5 x 2	1
P911506	Brown	53 x 32,5 x 2	1
P911508	Black	53 x 32,5 x 2	1

P9116 60 x 40 x 2



With silicon feet
Con pies sílica
Avec pieds en silicone

REF	Color	W x D x H cm	
P911601	White	60 x 40 x 2	1
P911602	Red	60 x 40 x 2	1
P911603	Blue	60 x 40 x 2	1
P911604	Yellow	60 x 40 x 2	1
P911605	Green	60 x 40 x 2	1
P911606	Brown	60 x 40 x 2	1
P911608	Black	60 x 40 x 2	1

P9135 Bar



Without feet
Sin pies
Sans pieds

REF	Color	W x D x H cm	
P913501	White	16 x 25 x 1	1
P913601	White	25 x 20 x 1	1
P913701	White	30 x 20 x 1	1
P913901	White	32 x 24 x 1	1

P911407



With silicon feet
Con pies sílica
Avec pieds en silicone

REF	W x D x H cm	
P911407	40 x 30 x 2	1
P911507	53 x 32,5 x 2 (1/1)	1
P911607	60 x 40 x 2	1

P9130 Cutting board table

Mesa de corte
Table de découpe



With groove
Con ranura
Avec rigole

Delivered without the GN container
No incluye contenedor Gastronorm
Livré sans le bac GN

Perfect for storing direct cut products into a 1/3 GN pan
Para almacenar alimentos recién cortados en cubeta GN 1/3
Permet découper les produits directement au dessus du bac Gastronorme 1/3

REF	Color	W x D x H cm	
P913000	White	65 x 40 x 11	1

P901 St/Steel vegetable picker

Recogeverduras inox
Pelle à légumes inox



REF	cm	
P901014	14 x 10	1
P901018	18 x 12	1



5.4 Measuring utensils

Elementos de medida
Ustensiles de mesure

47058 Oval measuring scoop
Cuchara oval medidora
Cuillère à mesurer ovale



NEW!

REF	L cm	ml	
47058	25,5	120	12

47054 Set 3 measuring oval scoops
Set de 3 cucharas ovals medidoras
Set de 6 cuillères à mesurer ovales



NEW!

REF	ml	
47054	30 / 60 / 120	5

4702 Long handle round measuring spoon
Cuchara medidora redonda mango largo
Cuillère à mesurer ronde à long manche



NEW!

REF	ml	
47025	1	12
47026	2	12
47027	5	12
47028	15	12
47029	30	12

47031 5 piece round measuring spoon long handle
Set de 5 cucharas medidoras con mango
Set de 5 cuillères à mesurer avec poignée



NEW!

REF	ml	
47031	30 / 15 / 5 / 2,5 / 1,25	12

44572 5-piece measuring ladle set
Set de 5 cucharones medidores
Set de 5 cuillères à mesurer



NEW!

REF	ml	
44572	15 / 5 / 2,5 / 1 / 0,5	12

46588 6-piece oval measuring spoon set
Set de 6 cucharas ovals medidoras
Set de 6 cuillères à mesurer ovales



NEW!

REF	ml	
46588	15 / 10 / 5 / 2,5 / 1,25 / 0,625	12

Measuring utensils 5.4

Elementos de medida
Ustensiles de mesure

46589 4- straight side measuring spoon set.
Set de 4 cucharas medidoras
Set de 4 cuillères à mesurer



NEW!

REF	ml	
46589	30 / 15 / 10 / 5	12

47119 4- piece measuring cup set
Set 4 tazas medidoras
Set de 4 tasses à mesurer



NEW!

REF	ml	
47119	240 / 120 / 80 / 60	12

47118 4-piece round measuring spoon set
Set 4 cucharas medidoras redondas
Set de 4 cuillères à mesurer rondes



NEW!

REF	ml	
47118	15 / 5 / 2,5 / 1,25	12

P6045 St/Steel 4 pcs set measuring cups
Juego 4 cazos de medidas inox
Set 4 casseroles doseur



REF	ml	
P604500	59 - 78 - 118 - 236	12

466 Ramekins
Ramekin
Ramequin



NEW!

REF	Ø cm	ml	
46654	5,7	59	12
46655	6,7	89	12
46661	7,6	118	12

4665 Measuring ramekins
Ramekin medidor
Ramequin à mesurer



NEW!

Capacities clearly stamped on product
Capacidades claramente indicadas en el producto
Capacités indiquées sur le produit

REF	Ø cm	ml	
46656	7,9	118	12
46657	9,8	236	12
46658	11,2	354	12
46659	12,3	473	12

5.4 Measuring utensils

Elementos de medida
Ustensiles de mesure

95160 Graduated measuring cup set
Kit tazas medidoras
Kit tasses à mesurer



REF	Ø cm	Lts	
95160	8,8	0,47	6
95320	11,7	0,90	6
95640	9,0	1,90	6

682-683 Aluminum measuring cups
Tazas medidoras de aluminio
Tasses à mesurer en aluminium



REF	H cm	Lts	
68297	10,6	0,5	6
68296	14,0	0,9	6
68351	18,0	1,9	6
68352	23,5	3,8	6

P604 Measuring jug
Jarra de medidas
Pot mesureur



REF	Lts	
P604001	1,00	1
P604002	2,00	1

P846 Polypropylene measuring jug
Jarra de medidas en polipropileno
Pot mesureur en polypropylène



REF	Lts	
P846025	0,25	25
P846050	0,50	16
P846100	1,00	12
P846200	2,00	12
P846300	3,00	10

P603 Bucket with base
Cubo con base
Seau avec base

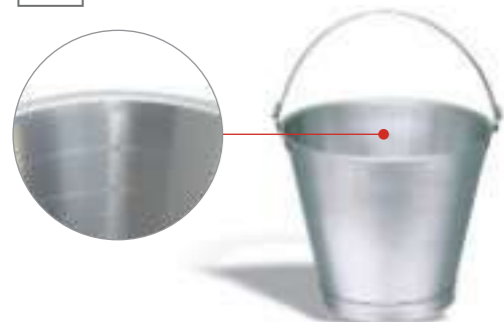

REF	Ø cm	H cm	Lts	
P603012	31,0	28,50	12,00	1
P603015	32,5	32,50	15,00	1

Measuring utensils 5.4

Elementos de medida
Ustensiles de mesure

P609 Electronic scale
Balanza digital
Balance électronique



Power cable not included. Battery powered
Cable de alimentación no incluido. Funciona con pilas
Câble d'alimentation non inclus. Fonctionne avec des piles

REF	kg	min. g	
P609010	10	20	6

P6097 Electronic kitchen scale
Balanza electrónica
Balance électronique



High accuracy
Multi-function weight and counting
Energy-saving system
Plastic Platform.

Gran precisión
Multifunción de peso
Contador de piezas
Sistema ahorro energía
Bandeja de plástico.

Haut précision
Multi-fonction des poids
Compteur des pièces
Système d'économie d'énergie
Plateau en plastique.



Ref	kg	Grs	Surface / Plataforma / Plateau Ø cm	
P609705	5	1	11	60

P611 Kitchen timer alarm
Reloj de cocina digital
Minuteur de cuisine



Battery not included
Pila no incluida
Pile non incluse



REF	W x D x H cm	
P611000	6,8 x 6,8 x 2,5	200

P6092 Digital kitchen scale
Balanza digital
Balance électronique



Surface made of St/Steel. LED Display. Battery powered
Plataforma en acero inoxidable. Pantalla LED. Funciona con pilas
Plateau fabriquée en acier inoxydable. Scran LED. Fonctionne avec des piles

REF	kg	min. g	d (g)	
P609200	15	40	1	10

P9804 Infrared thermometer with laser pointer
Termómetro infrarrojos con mira laser
Thermomètre infra-rouge à visée laser



LCD Display
Pantalla LCD
Écran LCD



IDEA!
Non-contact temperature measure food's surface.
Ideal para medir la temperatura de la superficie de los alimentos, sin contacto.
Ideal pour la mesure de température de surface des aliments, sans contact.

REF	L cm	Temp.	
P980400	17	-60 °C / +500 °C	1

P9802 Cooking thermometer
Termómetro de cocción
Thermomètre à cuisson



With plastic protection
Con protección de plástico
Avec gaine plastique



REF	L cm	Temp. max.	
P980200	28	100 °C	1

5.4 Measuring utensils

Elementos de medida
Ustensiles de mesure

P9816 Cooking thermometer
Termómetro de cocción
Thermomètre à cuisson



With plastic protection
Con protección de plástico
Avec gaine plastique

REF	L cm	Temp.	
P981600	17	-10 °C / +200 °C	1

P9815 Cooking thermometer with timer
Termómetro digital de cocción con temporizador
Thermomètre à cuisson avec temporisateur



P981650 Pocket thermometer with protection
Termómetro bolsillo con protección
Thermomètre de poche avec protection



REF	L cm	Temp.	
P981650	14,3	-40 °C / +70 °C	72

REF	guage + cable sonda + cable sonde + câble L cm	Temp.	
P981500	9	0 °C / +200 °C	1

White plastic.
Magnetic base for attachment on metal surface.
Programmable temperature/time, with alarm signal.
St/Steel probe and wire cable.

Plástico blanco.
Base magnética para sujeción en superficies de metal.
Temperatura/tiempo programable con señal de alarma.
Sonda de acero inoxidable y cable alambre.

Plastique blanc.
Base magnétique pour l'attacher à une surface métallique.
Température/temps programmable avec sonnette d'alarme.
Sonde inox et filet.

P9800 Cold storage thermometer
Termómetro nevera
Thermomètre congélateur



Enameled finish
Acabado esmaltado
Émaillé

REF	L cm	Temp.	
P980000	28	-30 °C / +50 °C	1

P98005 Horizontal refrigerator thermometer
Termómetro nevera horizontal
Thermomètre congélateur horizontal



REF	cm	Temp.	
P980050	13,5 x 3,5	-40 °C / +20 °C	72

Mitt 5.5

Manopla
Gan

P9473 Heat protection gloves
Guantes protección térmica
Gants protection thermique



Sold in pairs
Se venden por pares
Vendues par paires

- Resistant to contact heat. 100°C for 15 minutes.
- Great resistance to abrasion, greater durability.
- Resistant to grease, water, oil and dust.

- Resistente al calor por contacto. 100°C durante 15 minutos.
- Gran resistencia a la abrasión, mayor durabilidad.
- Resistente a grasa, agua, aceite y polvo

- Résistant à la chaleur par contact. 100°C pendant 15 minutes.
- Grande résistance à l'abrasion, plus grande durabilité.
- Résistant à la graisse, à l'eau, à l'huile et à la poussière

REF	Size / Talla / Taille	
P947302	M	1
P947303	L	1

P9474 Silicone oven mitt
Manopla Silicona
Moufle en silicone



REF	L cm	
P947400	30	1

P9477 Silicone oven glove with cotton cover
Manopla silicona con funda algodón
Gant silicone à fourreau coton



REF	L cm	
P947700	42,5	1

P9476 Silicone pot-grabber
Paño de silicona
Torchon en silicone



REF	cm	
P947600	17,5 x 17,5	12

Natural rubber mats

Alfombras caucho
Tapis en caoutchouc

P26000 Mat
Alfombra
Tapis



✓ REACH
COMPLIANT

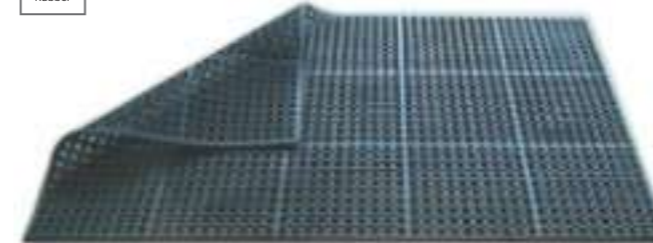

REF	W x D x H cm	
P26000	90 x 150 x 1,20	1

P26001 Mat
Alfombra
Tapis



✓ REACH
COMPLIANT

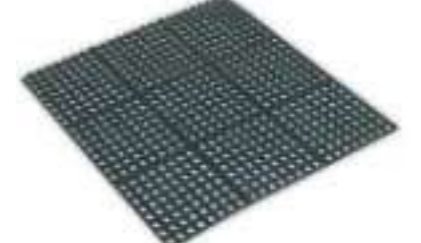

You can connect these mats forming bigger surfaces.

Estas alfombras se pueden conectar unas con otras formando mayores superficies.

Avec système de liaison pour composer une surface plus grande.

REF	W x D x H cm	
P26001	90 x 90 x 1,20	1

6 Ice-cream utensils & pastry

Heladería y pastelería

Ustensiles à glace et pâtisserie



- | | |
|---|-----|
| 6.1 ICE-CREAM UTENSILS | 152 |
| <i>UTENSILIOS HELADERÍA</i>
USTENSILES POUR GLACE | |
| 6.2 PASTRY UTENSILS | 154 |
| <i>UTENSILIOS DE PASTELERÍA</i>
USTENSILES DE PÂTISSERIE | |
| 6.3 NON-STICK MOULDS | 163 |
| <i>MOLDES ANTIADHERENTES</i>
MOULES ANTI-ADHÉSIFS | |
| 6.4 PASTRY CUTTER | 166 |
| <i>CORTA PASTAS</i>
DÉCOUPOIRS | |
| 6.5 ST/STEEL PASTRY MOULDS | 167 |
| <i>MOLDES ACERO INOXIDABLE</i>
MOULES EN ACIER INOX | |
| 6.6 BAGS AND TUBES | 170 |
| <i>MANGAS Y BOQUILLAS</i>
POCHES ET DOUILLES | |
| 6.7 FLEXIPAN MOULDS | 175 |
| <i>MOLDES FLEXIPAN</i>
MOULES FLEXIPAN | |
| 6.8 SILICON MOULDS | 182 |
| <i>MOLDES SILICONA</i>
MOULES SILICONE | |

6.1 Ice-cream utensils

Utensilios heladería
Ustensiles pour glace

47169 Ice cream scoop Racionador de helado Cuillère à glace

SS
Stainless steel



NEW!

REF	Size Tamaño	L cm	ml	
47169	14	68,0	26	10
47170	20	46,0	46	10
47171	24	38,0	38	10
47172	30	28,0	28	10
47200	40	22,2	22	10

47150 Round squeeze disher Racionador helado Doseur à presser ronde

SS
Stainless steel



REF	Size Tamaño	L cm	ml	
T7206	6	23,2	158	12
47150	8	23,2	118	12
47151	10	22,5	92	12
47152	12	22,5	81	12 NEW
47153	16	21,6	59	12
47154	20	21,6	44	12 NEW
47155	24	21,0	41	12
47156	30	21,0	37	12 NEW
47157	40	20,3	26	12
47158	50	20,0	18	12 NEW
47159	60	19,7	17	12
47160	70	19,7	14	12
47161	100	19,1	11	12

P331 Ice cream scoop Racionador de helado Cuillère à glace

SS
Stainless steel



REF	Ø cm	ml	
P331039	3,9	15	120
P331044	4,4	22	120
P331050	5,0	32	120
P331056	5,6	46	120
P331059	5,9	54	120
P331066	6,6	75	120
P331070	7,0	90	120

P908 Ice cream scoop Racionador de helado Cuillère à glace

SS
Stainless steel

Mc
Methacrylate



*Methacrylate

REF	Colour / Color / Couleur	L cm	
P908000	White / Blanca / Blanc	26	50
P908001*	Clear / Transparente / Transparente	26	100
P908002	Red / Roja / Rouge	26	100
P908003	Blue / Azul / Bleu	26	1
P908004	Yellow / Amarilla / Jaune	26	1

47274 Ice cream scoop Racionador helado Cuillère à glace

Bol cm



L cm

REF	Color	Size Tamaño	Bol cm	L cm	ml	
47274	●	10	5,4	19,5	118,3	12
47275	●	12	5,2	19,5	88,7	12
47276	●	16	4,8	19,5	73,9	12
47277	●	20	4,4	19,0	59,1	12
47278	●	24	4,1	19,5	44,4	12
47279	●	30	3,7	19,0	29,6	12

Ice-cream utensils 6.1

Utensilios heladería
Ustensiles pour glace

P914 36 x 16,5 cm

18/10
Stainless steel



REF	W x D x H cm	Lts	
P914080	36 x 16,5 x 8	3,4	10
P914120	36 x 16,5 x 12	5,0	10
P914150	36 x 16,5 x 15	7,0	10

P915 36 x 25 cm

18/10
Stainless steel



REF	W x D x H cm	Lts	
P915080	36 x 25 x 8	5,4	10

P9161 360 x 165 mm

PC
Polycarbonate



REF	cm	H cm	Lts	
P916120	36 x 16,5	12	5	1

P917 360 x 250 mm

PC
Polycarbonate



REF	W x D x H cm	Lts	
P917080	36 x 25 x 8	3,4	1

P9160 Polycarbonate lid Tapa policarbonato Couvercle en polycarbonate

PC
Polycarbonate



Adjustable for St/Steel Ice cream containers.
Adaptable a cubetas heladería inox y policarbonato.
Adaptable aux récipient à glace en acier inox.

REF	cm	
P916000	36 x 16,5	1

P332 Ice cream cup Copa helado Coupe à glace

SS
Stainless steel



P332010

P332095

REF	Ø cm	H cm	Lts	
P332095	9,5	8,5	0,15	100
P332010	10,5	6,0	0,17	120

6.2 Pastry utensils

Utensilios de pastelería
Ustensiles de pâtisserie



P120101 GN Pastry Pan
Cubeta GN Pastelería
Bac GN pâtisserie

NEW!



REF	GN	W x D x H cm	
P120101	1/2	32,5 x 26,5 x 1	1

P230101 GN Pastry Pan
Cubeta GN Pastelería
Bac GN pâtisserie

NEW!



REF	GN	W x D x H cm	
P230101	2/3	35,3 x 32,5 x 1	1

P110101 GN Pastry Pan
Cubeta GN Pastelería
Bac GN pâtisserie

NEW!



REF	GN	W x D x H cm	
P110101	1/1	53 x 32,5 x 1	1

P306 Mixing boiler
Caldero timbal
Bol mixeur



REF	Ø cm	H cm	Lts	
P306035	35	18	10	1

P3070 Boiler
Caldero fondo plano
Bassine à fond plat



REF	Ø cm	H cm	Lts	
P307020	20	10,5	2,2	1
P307025	25	11,5	3,5	1
P307030	30	14,0	6,0	1
P307035	35	14,5	8,5	1
P307040	40	16,5	13,0	1
P307045	45	17,5	20,0	1
P307050	50	20,0	25,0	1
P307060	60	22,5	45,0	1
P307070	70	24,5	65,0	1

P3071 Conical boiler
Caldero fondo bombeado
Bassine à fond bombé / Kessel



REF	Ø cm	H cm	Lts	
P307125	25	13,0	3,8	1
P307130	30	16,0	6,5	1
P307140	40	19,0	13,0	1
P307150	50	23,5	25,0	1

Pastry utensils 6.2

Utensilios de pastelería
Ustensiles de pâtisserie

P356 Kitchen bowl
Fuente honda cónica
Bassine pâtissière



Outer sizes
Medidas exteriores
Dimensions extérieures

REF	Ø cm	H cm	Lts	
P356016	16	5,5	0,65	96
P356020	20	7,5	1,30	72
P356024	24	8,5	2,10	36
P356028	28	11,0	3,70	36
P356032	32	12,5	6,00	24

479 Stainless Steel mixing bowl
Bol inox. semi-esférico
Bassine inox demi-ronde



REF	Ø cm	Lts	
47933	24	2,8	12
47934	28	3,8	12
47935	30	4,7	12
47938	35	7,6	12
47943	40	12,0	6

P764 Hemispherical mould
Molde semiesférico
Demi-sphérique



REF	Ø cm	H cm	Lts	
P764008	8	4,0	0,13	1
P764010	10	5,0	0,26	1
P764012	12	6,2	0,45	1

P951 St/Steel scoop
Librador de acero inox
Pelle à farine en acier inox



REF	L cm	Lts	
P951010	10	0,1	1
P951015	15	0,4	1
P951019	19	1,0	1
P951024	24	1,7	1

P953 Aluminum scoop
Librador aluminio
Pelle à farine aluminium



REF	L cm	Lts	
P953001	11,0	0,15	72
P953002	15,0	0,35	72
P953003	18,5	0,71	72
P953004	21,5	1,10	48
P953005	25,5	1,71	36

P952 Polycarbonate scoop
Librador policarbonato
Pelle à farine polycarbonate

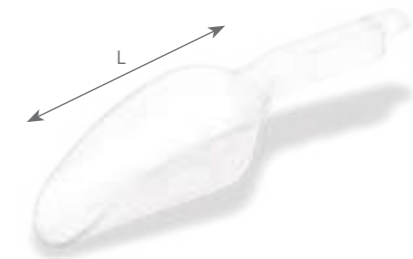

REF	L cm	Lts	
P952001	13,0	0,17	72
P952002	15,5	0,35	72
P952003	17,5	0,71	48

6.2 Pastry utensils

Utensilios de pastelería
Ustensiles de pâtisserie

SS
Stainless
steel

P316 Whisk (12 wires)
Batidor (12 varillas)
Fouet (12 fils)

**BEST
SELLER**



Wire thickness
Grueso varilla
Épaisseur des fils
0,13 cm

REF	L cm	
P316025	25	120
P316030	30	120
P316035	35	120
P316040	40	120
P316045	45	120
P316050	50	120

P3161 Whisk (10 wires)
Batidor (10 varillas)
Fouet (10 fils)



Wire thickness
Grueso varilla
Épaisseur des fils
0,18 cm

REF	L cm	
P316125	25	120
P316130	30	120
P316135	35	120
P316140	40	120
P316145	45	120
P316150	50	120

P354 Heavy whisk (8 wires)
Batidor grueso (8 varillas)
Fouet épais (8 fils)



Wire thickness
Grueso varilla
Épaisseur des fils
0,24 cm

REF	L cm	
P354025	25	120
P354030	30	120
P354035	35	120
P354040	40	120
P354045	45	120
P354050	50	120

P959 Whisk with anti-slip ABS handle (8 wires)
Batidor mango ABS antideslizante (8 varillas)
Fouet avec poignée ABS anti-crispation (8 fils)



Wire thickness
Grueso varilla
Épaisseur des fils
0,2 cm

REF	L cm	
P959025	25	96
P959030	30	1
P959035	35	48
P959040	40	48
P959045	45	24
P959050	50	24

P393 Big whisk
Batidor gigante
Fouet à purée

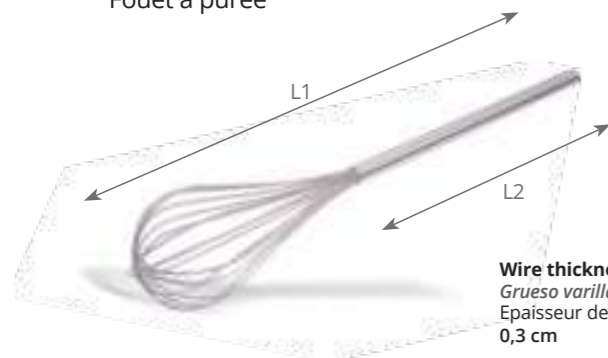

Wire thickness
Grueso varilla
Épaisseur des fils
0,3 cm

REF	L1 cm	L2 cm	
P393080	80	45	12
P393100	100	65	12
P393125	125	90	12

47002 Whisk with anti-slip handle
Batidor con mango antiadherente
Fouet avec poignée anti-crispation



REF	L cm	L mango cm	
47002	26	12	12
47003	31	12	12
47004	36	12	12
47005	41	12	12

Pastry utensils 6.2

Utensilios de pastelería
Ustensiles de pâtisserie

P398 Rubber spatula
Espátula de goma
Spatule en caoutchouc

EVA



REF	L cm	
P398024	25,5	72
P398035	33,0	72
P398042	41,0	72

Anatomical handle. Suitable rubber for food contact. Safe dishwasher. Special mould that prevents the rubber to come off from the handle.

Mango ergonómico. Goma aceptada para uso alimentario. Puede lavarse en el lavavajillas. Moldeado especial que previene la separación de la goma del mango.

Manche anatomique. Caoutchouc conforme au contact alimentaire. Utilisable au lave-vaisselle. Moulage spécial pour éviter la séparation de la gomme du manche.

P398290 Narrow rubber spatula
Espátula estrecha goma
Spatule étroite en caoutchouc

EVA



IDEA! Perfect to empty small jars
Perfecta para vaciar tarros
Parfait pour vider des petits pots

REF	Peel / Pala / Pelle cm	L cm	
P398290	8,8 x 3,3	25,5	72

P3981 High heat silicone spatula. Bowl scraper
Espátula silicona alta temperatura
Spatule silicone haute température

Si
Silicone

Heat resistance to 260 °C
Resistente hasta 260 °C
Résistante à 260 °C



REF	Peel / Pala / Pelle cm	L cm	
P398125	9 x 6	25	72
P398135	11 x 7	35	72
P398140	11 x 7	40	72

P3982 High heat silicone spoon
Cuchara silicona alta temperatura
Cuillère silicone haute température

Si
Silicone

Heat resistance to 260 °C
Resistente hasta 260 °C
Résistante à 260 °C



REF	Peel / Pala / Pelle cm	L cm	
P398225	9 x 6	25	144
P398235	11 x 7	35	144
P398240	11 x 7	40	144

P9602 Multi-purpose spatula
Espátula multi-usos
Spatule multi-usage

PS
Polystyrene

PE
Polyethylene

-5 °C
+70 °C



REF	L cm	
P960225*	25	200
P960230*	30	200
P960235**	35	200

* Polyestyrene / Poliestireno / Polyestyrène
** Polyethylene / Polietileno / Polyéthylène

6.2 Pastry utensils

Utensilios de pastelería
Ustensiles de pâtisserie

P807 Roller docker
Rodillo para perforar pasta
Rouleau pour piquer pâtes



REF **P807000** 24

P839 Roller docker
Rodillo para perforar pasta
Rouleau pour piquer pâtes



REF **P839000** 12

P840 Lattice cutting roller
Rodillo enrejado
Rouleau découpoir



REF **P840000** 1

P842 Double pastry cutter. Plain and serrated
Cortapastas doble. Liso y rizado
Roulette à pâtes double. Unie et cannelée



REF **P842000** 12

P805 Extendable cutter roller 7 castors
Cortapastas extensible 7 ruedas
Rouleau extensible 7 roulettes

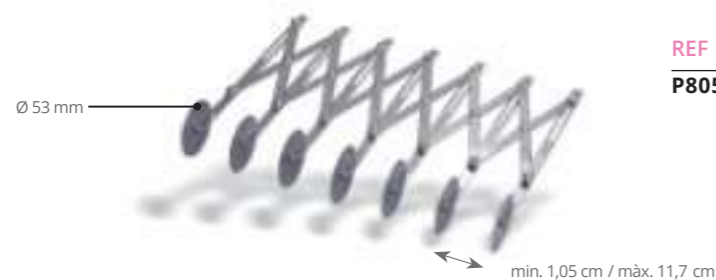

REF **P805000** 36

Pastry utensils 6.2

Utensilios de pastelería
Ustensiles de pâtisserie

P801 St/Steel rolling pin
Rodillo acero inox
Rouleau pâtissier acier inox

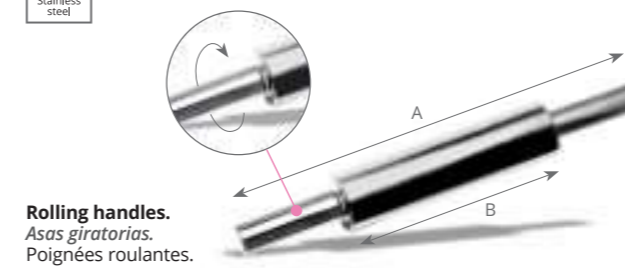

Rolling handles.
Asas giratorias.
Poignées roulantes.

REF	A cm	B cm	Ø cm	
P801040	40	20	5,1	12
P801048	48	25	6,4	8

P802 Polyethylene rolling pin with handles
Rodillo polietileno con asas
Rouleau en polyéthylène avec poignées

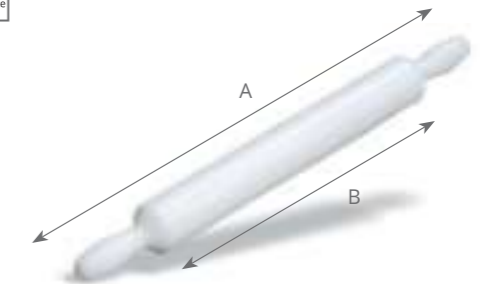

REF	A cm	B cm	Ø cm	
P802000	60	40	4,8	1

P803 Polyethylene rolling Pin without handles
Rodillo polietileno sin asas
Rouleau en polyéthylène Sans poignées



REF	L cm	Ø cm	
P803000	50	4,8	1

P804 Wooden rolling pin
Rodillo de madera
Rouleau en bois

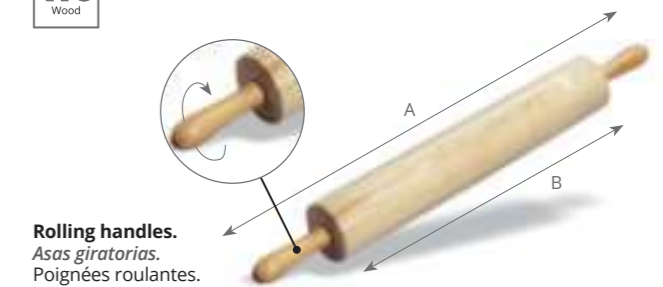

Rolling handles.
Asas giratorias.
Poignées roulantes.

REF	A cm	B cm	Ø cm	
P804000	67,5	45,5	7,7	6

P845 Polyamide brush
Pincel de poliamida
Pinceau en polyamide



Natural fibers
Fibras naturales
Fibres Naturelles

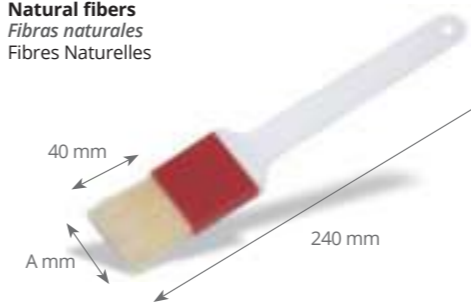

REF	A cm	
P845040	4,0	12
P845050	5,0	12
P845060	6,0	12
P845075	7,5	12

P8451 Plastic brush + nylon bristle
Cepillo plástico + cerdas nylon
Pinceau plastique + poils nylon

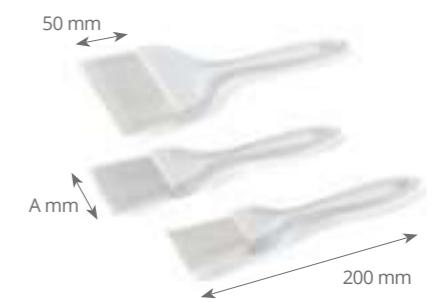

REF	A cm	
P845138	3,8	144
P845155	5,5	144
P845110	10,0	72

6.2 Pastry utensils

Utensilios de pastelería
Ustensiles de pâtisserie

P8725 Scraper ABS handle
Rasqueta mango ABS
Raclette manche ABS



REF	cm	
P872500	21 x 14,5	144

P836 Polypropylene scrapers
Rasquetas de polipropileno
Raclettes en polypropylène

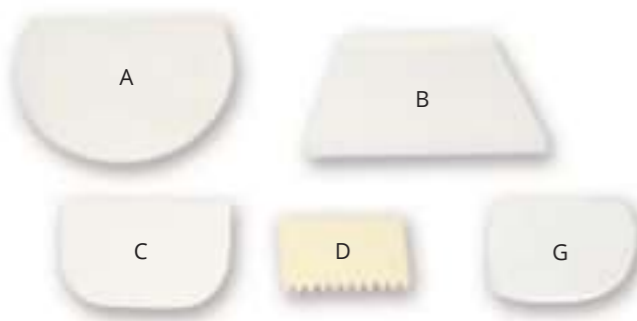

P848 Double cake divider
Marcador de tartas doble
Séparateur de portions double



Ø Total: 26,5 cm

REF	Portions / Porciones	
P848008	8 / 12	1
P848014	14 / 16	1

REF		cm	
P836200	A	20,4 x 15,1	1
P836215	B	22,1 x 13,0	100
P836147	C	15,1 x 10,2	100
P836110	D	11,2 x 7,8	100
P836120	G	12,8 x 9,0	100

REF	cm	
P979100	10 x 13,6	36
P979200	13 x 17,5	1
P979000	16,5 x 21	20

IDEA! Kitchen use, defrosting, sterilizing, ice sculpture, crème brûlée, caramelization
Descongelación, esterilización, escultura de hielo, crema brulée, caramelización
Décongélation, stérilisation, sculpture de glace, crème brulée, caramélisation

P979 Pastry torch by gas
Soplete cocina
Torche à caraméliser



120 min.
Lenght / Duración / Durée



P979000
Super strong flame
Llama super fuerte
Flamme extra fort



P979200
Strong flame
Llama fuerte
Fort flamme



P979100
Standar flame
Llama normal
Flamme normal

Pastry utensils 6.2

Utensilios de pastelería
Ustensiles de pâtisserie

P350 St/Steel sieves
Cedazos en acero inox
Tamis en acier inox



Detail of the 6 sieves at real scale.
Detalle de las 6 mallas a escala real.
Détail des 6 mailles à échelle réelle.

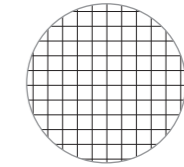

REF	Ø cm	Num	Mesh size / Luz de malla Maillage cm	
P350230	30	10	0,2	6
P350235	34	10	0,2	6

REF	Ø cm	Num	Mesh size / Luz de malla Maillage cm	
P350330	30	14	0,14	6
P350335	34	14	0,14	6

REF	Ø cm	Num	Mesh size / Luz de malla Maillage cm	
P350530	30	25	0,071	6
P350535	34	25	0,071	6

REF	Ø cm	Num	Mesh size / Luz de malla Maillage cm	
P350630	30	35	0,05	6
P350635	34	35	0,05	6

REF	Ø cm	Num	Mesh size / Luz de malla Maillage cm	
P350730	30	50	0,030	6
P350735	34	50	0,030	6

REF	Ø cm	Num	Mesh size / Luz de malla Maillage cm	
P350426	26	20	0,085	6
P350430	30	20	0,085	6
P350435	34	20	0,085	6
P350440	40	20	0,085	6

P837 Aluminium cake stand
Expositor de tartas de aluminio
Présentoir de tartes en aluminium

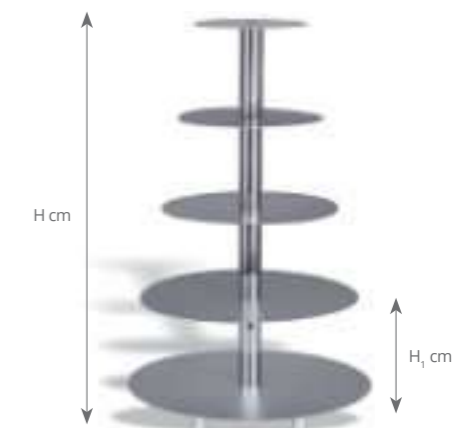

REF	H cm	H ₁ cm	Ø cm	
P837003	33	2 x 16,5	20 / 26 / 32	1
P837005	100	4 x 25,0	20 / 26 / 32 / 40 / 45	1
P837007	120	6 x 20,0	16 / 20 / 26 / 32 / 40 / 45 / 50	1

6.2 Pastry utensils

Utensilios de pastelería
Ustensiles de pâtisserie

P830 Confectionery funnel

Embudo dosificador
Entonnoir doseur



Tube Ø 0,4 and 0,6 cm included
Boquilla Ø 0,4 y 0,6 cm incluidas
Douille de Ø 0,4 et 0,6 cm incluse

REF	Lts	
P830001	1	1
P830002	2	1

P830005 Basic confectionery funnel with stand

Embudo dosificador básico con soporte
Entonnoir doseur de base avec support



Funnel and stand sold together.
Embudo y soporte se venden conjuntamente.
Entonnoir et support vendu ensemble.

REF	Lts	
P830005	1	6

2803 Portion control dispenser

Dispensador con control de porciones
Distributeur contrôle de la partie



Not recommended for chunky batters.
No se recomienda para batidos espesos.
Non recommandé pour les pâtes grumeleuses.

8 portion control settings dispense from 30 a 90 ml.
Los ajustes de control de 8 porciones dispensan de 30 a 90 ml.
8 réglages de dose - 30 à 90 ml.

REF	L	W x D x H cm	
2803-18	1,4	15,6 x 27,6 x 19,1	1

P830003 Economic confectionery funnel and stand

Embudo dosificador económico y soporte
Entonnoir doseur économique et support



Tube Ø 0,4 and 0,6 cm included
Boquilla Ø 0,4 y 0,6 cm incluidas
Douille de Ø 0,4 et 0,6 cm incluse

REF	Lts	
P830003	1	12
P830004		12

See products on **P. 118**
Ver productos en / Voir produits en page

P970 Stand for funnel or chinese colander

Soporte para embudo o chino
Support pour entonnoir ou chinois



P9095 St/steel pastry grid with feet

Rejilla inox pastelería con pies
Grille pâtisserie inox avec pieds

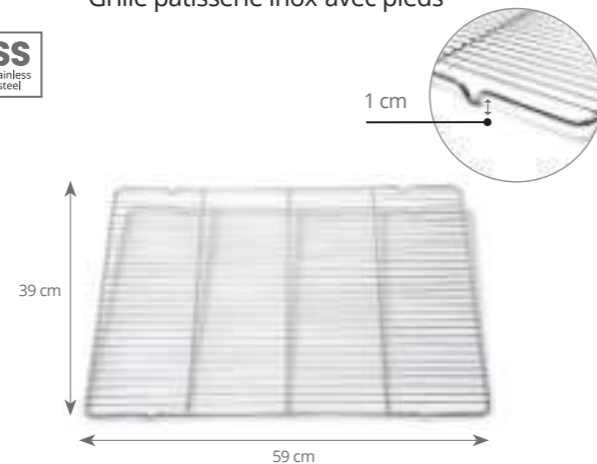

REF	N. Cross-bars Travesaños Traverses	Ø mm Cross-bars Travesaños Traverses	N. Wires Varillas Fils	Ø mm Wires Varillas Fils	
P909559	3	5	29	2	10

Non-stick moulds 6.3

Moldes antiadherentes
Moules anti-adhésifs



P7022 Professional cake mould

Molde cake profesional
Cake embouti professionnel



REF	cm (int.)	H cm	Lts	
P702230	30 x 10,5	8,0	2,0	24

P702 Cake mould

Molde cake
Cake embouti



REF	W x D x H cm	
P702026	26 x 9,5 x 7,5	1
P702028	28 x 10 x 7,5	20

P704 Folding cake mould

Molde para paté o cake desmontable
Pâté ou cake démontable



REF	W x D x H cm	
P704024	24 x 9,5 x 7	1
P704030	30 x 10 x 7,5	20

P709 Baking mould w/removable base

Molde fondo desmontable
Tarte maison a/fond amovible



REF	W x D x H cm	
P709035	35 x 11 x 2,5	1

P707 Small madeleine sheet

Placa madalenas pequeñas
Plaque madeleinettes



2 rows of 10 small madeleines of 4,2 cm.
2 hileras de 10 madalenas pequeñas de 4,2 cm.
2 rangées de 10 madeleinettes de 4,2 cm.

REF	cm	
P707039	39,5 x 12,5	1

P706 Madeleine sheet

Placa madalenas
Plaque madeleines



2 rows of 6 madeleines of 8 cm.
2 hileras de 6 madalenas de 8 cm.
2 rangées de 6 madeleines de 8 cm.

REF	cm	
P706039	39,5 x 20	1

6.3 Non-stick moulds

Moldes antiadherentes
Moules anti-adhésifs

St
Steel

P723 Non-stick spring form
Molde desmontable Antiadherente
Moule rond démontable



REF	Ø cm	H cm	
P723024	24	7,0	6
P723028	28	7,0	6

P703 High cake mould
Molde para tarta
Manqué rond uni



REF	Ø cm	H cm	
P703020	20	4,5	1
P703024	24	5,0	36
P703028	28	5,0	30
P703032	32	5,5	1

P710 Round tart mould with fluted edges
Molde rizado para tarta
Tourtière ronde avec Bord cannelé



REF	Ø cm	H cm	
P710020	20	2,5	50
P710024	24	2,5	40
P710028	28	2,5	36

P711 Fluted edge mould with removable base
Molde rizado fondo desmontable
Tourtière avec fond amovible



REF	Ø cm	H cm	
P711010	10	1,8	240
P711012	12	2,0	144
P711020	20	2,5	50
P711024	24	2,5	40
P711028	28	2,5	36
P711032	32	2,5	30

P708 Savarin mould
Molde savarin
Moule savarin



REF	Ø cm	H cm	
P708008	8	2,0	1
P708022	22	4,5	1
P708024	24	5,0	1

P712 "Trois frères" ring mould
Molde savarin "trois frères"
Moule savarin "trois frères"



REF	Ø cm	H cm	
P712022	22	5,5	1

Non-stick moulds 6.3

Moldes antiadherentes
Moules anti-adhésifs

St
Steel

P713 Oval aspic mould
Molde ovalado para aspic
Moule aspic ovale



REF	cm	H cm	
P713075	7,5 x 5,5	3,8	240

P717 Plain oval boat mould
Molde barquita lisa
Moule Barquette unie



REF	cm	H cm	
P717008	8 x 3,3	1,2	1
P717010	10 x 4,3	1,3	1

P720 Round fluted tart mould
Molde tartaleta acanalada redonda
Moule tartelette ronde cannelée



REF	Ø cm	H cm	
P720005	5	1,2	576
P720006	6	1,2	576
P720007	7	1,2	1
P720008	8	1,2	432
P720010	10	1,8	240
P720012	12	2,0	144

P722 60 "Petits fours" moulds set
Caja de 60 pequeños moldes "Petits Fours"
Boîte de 60 "petits fours"



P715 Baba mould
Molde redondo para bizcocho
Baba rond



Rolled edge
Borde vuelto
Bord roulé

REF	Ø cm	H cm	
P715006	6,5	6,0	192

P718 10 Wide ribs brioche mould
Molde madalenas con 10 costados
Moule brioche 10 côtes



Ø 6: 9 ribs. Other ø: 10 ribs
Ø 6: 9 costados. Resto ø: 10 costados
Ø 6: 9 côtes. Autres ø: 10 côtes

REF	Ø cm	H cm	
P718006	6	2,5	432
P718008	8	3,2	240
P718010	10	3,8	240
P718011	11	4,0	1

P721 Round plain tart mould
Molde tartaleta redonda lisa
Moule tartelette ronde unie



REF	Ø cm	H cm	
P721005	5	1,2	1
P721006	6	1,2	1
P721007	7	1,2	1
P721008	8	1,2	1
P721010	10	1,2	1

5 Pieces of each 12 "Petits fours".
5 Piezas de cada uno de los 12 "Petits fours".
5 Pièces de chacun des 12 "Petits fours".

REF		
P722000		1

6.4 Pastry cutter

Cortapastas
Découpoirs



P732 Set of 8 round plain cutters
Caja de 8 cortapastas redondos lisos
Boîte de 8 découpoirs ronds unis



REF	Ø cm	H cm	
P732000	3 / 4 / 5 / 6 / 7 / 8 / 9 / 10	3,5	1

P733 Set of 8 round fluted cutters
Caja de 8 cortapastas redondos rizados
Boîte de 8 découpoirs ronds cannelés



REF	Ø cm	H cm	
P733000	3 / 4 / 5 / 6 / 7 / 8 / 9 / 10	3,5	1

P796 9 pcs set polyglass plain cutters
Caja 9 cortapastas redondos lisos poliglas
Boîte 9 découpoirs ronds unis polyglass



REF	Ø cm	H cm	
P796000	2 / 3 / 4 / 5 / 6 / 7 / 8 / 9 / 10	3,5	1

P7961 9 pcs set polyglass fluted cutters
Caja 9 cortapastas redondos rizados poliglas
Boîte 9 découpoirs ronds cannelés polyglass



REF	Ø cm	H cm	
P796100	2 / 3 / 4 / 5 / 6 / 7 / 8 / 9 / 10	3,5	1

St/steel pastry moulds 6.5

Moldes acero inoxidable
Moules en acier inox



P780 Tart ring
Aro redondo para tarta
Cercle à tarte



REF	Ø cm	H cm	
P780006	6	2	1
P780008	8	2	100
P780010	10	2	100

P781 "Entremets" ring
Aro redondo para tarta
Cercle à entremets



REF	Ø cm	H cm	
P781006	6	3,5	100
P781008	8	3,5	100
P781010	10	3,5	100

P782 Mousse ring
Aro redondo para mousse
Cercle à mousse



REF	Ø cm	H cm	
P782075	7,5	4,0	100
P782008	8,0	4,5	1
P782010	10,0	4,5	100
P782012	12,0	4,5	1
P782014	14,0	4,5	1
P782016	16,0	4,5	50
P782018	18,0	4,5	50
P782020	20,0	4,5	20
P782022	22,0	4,5	20
P782024	24,0	4,5	20
P782026	26,0	4,5	20
P782028	28,0	4,5	20

P783 Ice cream cake ring
Aro redondo para tarta
Cercle à vacherin



REF	Ø cm	H cm	
P783006	6	6	100
P783008	8	6	100
P783010	10	6	50
P783012	12	6	1
P783014	14	6	50
P783016	16	6	50
P783018	18	6	50
P783020	20	6	20
P783022	22	6	20
P783024	24	6	20
P783026	26	6	20
P783028	28	6	20
P783030	30	6	6

P785 Mousse ring
Aro redondo para mousse
Cercle à mousse



REF	Ø cm	H cm	
P785006	6	4	100
P785008	8	4	100
P785010	10	4	100



Perfect for dishes presentation
Perfecto para presentación de platos
Idéal pour la présentation de plats

6.5 St/steel pastry moulds

Moldes acero inoxidable
Moules en acier inox

P765 Hexagon

Molde hexagonal
Hexagone

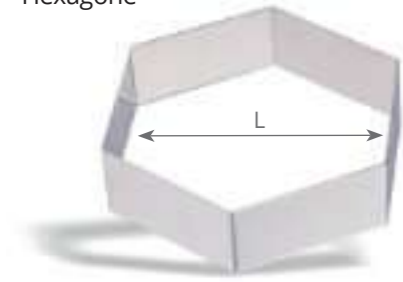

REF	L cm	H cm	
P765020	20	4,5	1
P765024	24	4,5	1

P768 Tear

Molde forma lágrima
Larme

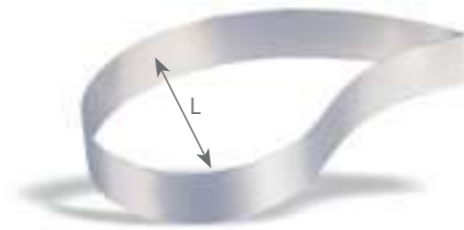

REF	L cm	H cm	
P768006	6	4,5	1
P768008	8	4,5	1

P771 Oval

Molde forma oval
Ovale

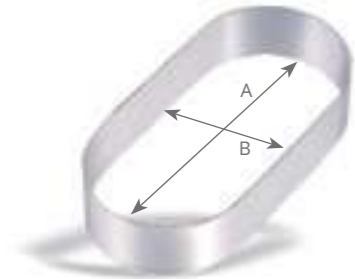

REF	L cm	H cm	
P771025	25 x 11,2	4,5	1

P769 Heart

Molde forma corazón
Coeur

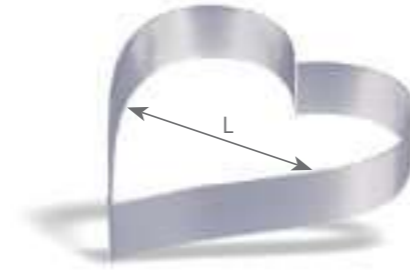

REF	L cm	H cm	
P769008	8	4,5	48
P769010	10	4,5	72
P769018	18	4,5	1
P769020	20	4,5	36
P769022	22	4,5	1

P992 PVC ribbon for mousse

Cinta PVC para mousse
Ruban pâtissier en PVC



REF	Length Longitud Longueur	H cm	
P992040	100 m	4,0	1
P992045	100 m	4,5	1
P992050	100 m	5,0	1

See products on / Ver productos en / Voir produits en page

P. 107

Fine tip straight tweezer

Pinza chef precisión
Pince du chef précision



St/steel pastry moulds 6.5

Moldes acero inoxidable
Moules en acier inox

P355 Caramel cream mould

Flanero
Moule à flan



REF	Ø cm	H cm	Lts	
P355007	7,5	5,2	0,12	288
P355008	8,5	5,4	0,17	288

P136 Reinforced caramel cream mould

Molde industrial para flan
Moule à flan



REF	Ø cm	H cm	Lts	
P136006	6	5,5	0,10	1
P136007	7	6,5	0,15	1
P136008	8	6,5	0,25	1

P789 Round cake mould

Molde 1/2 caña desmontable redondo
Gouttière ronde



REF	W x D x H cm	
P789025	25 x 9 x 6	1
P789050	50,5 x 9 x 9	1

P788 Triangle cake mould

Molde 1/2 caña desmontable triangular
Gouttière triangulaire



REF	W x D x H cm	
P788025	25 x 9 x 6	1
P788050	50 x 9 x 6	1

P784 Cake mould

Molde cake
Moule à cake

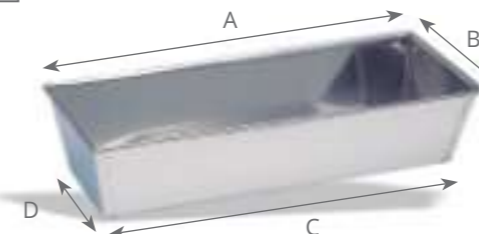

REF	A x B cm	C x D cm	H cm	
P784020	20 x 13	18,0 x 10	8	50
P784025	25 x 13	22,0 x 10	8	50
P784030	30 x 13	27,0 x 10	8	25
P784035	35 x 13	32,0 x 10	8	1
P784040	40 x 13	36,5 x 10	8	1

6.6 Bags and tubes

Mangas y boquillas
Poches et douilles



P800 Nylon pastry bags

Mangas de nylon
Poches pâtisseries en nylon



REF	cm	Ø cm	
P800030	30	17,0	1
P800035	35	19,5	1
P800040	40	22,0	1
P800045	45	25,0	1
P800050	50	27,5	1
P800055	55	30,5	1
P800060	60	33,0	1
P800065	65	35,0	1
P800070	70	39,0	1

Made in nylon and covered with polyurethane on one side. Waterproof, ultra light and very comfortable to use. Sterizable, without seams, thermowelded for long life and with an adjustable end.

Fabricadas en nylon y recubiertas de poliuretano por una cara. Impermeables y ultraligeras. Son muy cómodas de utilizar. Se pueden hervir. Sin costuras, termosoldadas de larga duración y con la punta ajustable.

Fabriquéées en tissu de nylon avec un revêtement polyuréthane sur une face. Impérmeables, très souples, ultralégères et très comodes au tact. Stérilisables, sans coutures, thermosoudées, de longue durée et avec l'embout ajustable.

P798 Disposable pastry bags

Mangas desechables
Poches jetables



REF	cm	Lts	
P798040	43	2,00	10
P798055	55	3,50	10
P798065	65	5,00	10

P851 Cotton pastry bag

Manga pastelera de algodón
Poches pâtisseries en cotton



REF	L cm	
P851040	40	1
P851046	46	1
P851050	50	1

P849 Support for pastry bags and tubes (nozzles)

Soporte para mangas pasteleras y boquillas
Support pour pochés pâtisseries et douilles



REF	
P849000	1

P798056 Green disposable pastry bags

Mangas desechables color verde
Poches jetables verdes



100 pieces set
Caja de 100 unidades
Boîte de 100 pièces

REF	cm	Lts	
P798056	55	3,50	1

Bags and tubes 6.6

Mangas y boquillas
Poches et douilles



P810 Plain tube

Boquilla redonda
Douille unie



REF	Ø cm	
P810004	0,4	500
P810006	0,6	500
P810008	0,8	500
P810010	1,0	500
P810012	1,2	500
P810014	1,4	500

P811 Star tube

Boquilla estrella
Douille cannelée



REF	Ø cm	N° Teeth / N° Puntas / N° Dents	
P811004	0,4	6	500
P811006	0,6	6	500
P811008	0,8	6	500
P811010	1,0	7	500
P811012	1,2	7	500
P811014	1,4	8	500
P811016	1,6	9	500

P812 Closed star tube

Boquilla estrella cerrada
Douille cannelée fermée



REF	Ø cm	N° Teeth / N° Puntas / N° Dents	
P812003	0,3	6	500
P812005	0,5	6	500
P812007	0,7	6	500
P812009	0,9	8	500
P812011	1,1	8	500

P813 Yule log tube

Boquilla cinta estrella
Douille à bûche de Noël



REF	cm	N° Teeth / N° Puntas / N° Dents	
P813016	1,6 x 0,2	6	500
P813020	2,0 x 0,3	6	500

P816 Flower tube

Boquilla flor
Douille fleur



REF	Ø cm	N° Teeth / N° Puntas / N° Dents	
P816011	1,1	6	500

P817 Closed flower tube

Boquilla flor cerrada
Douille fleur fermée



REF	Ø cm	N° Teeth / N° Puntas / N° Dents	
P817005	0,5	6	500
P817006	0,6	8	500
P817008	0,8	9	500

6.6 Bags and tubes

Mangas y boquillas
Poches et douilles



P815 "petits fours" tube Boquilla rizada Douille à "petits fours"



REF	Ø cm	N° Teeth / N° Puntas / N° Dents	1
P815006	0,6	9	500
P815009	0,9	12	500
P815012	1,2	15	500
P815015	1,5	16	500

P814 Bismark tube Boquilla para relleno Douille petit chou



REF	Ø cm	25
P814000	0,4	25

P820 Set of 6 tubes nr. 0 Conjunto de 6 boquillas n° 0 Boîte de 6 douilles num. 0



REF	1
P820000	1

Diameter exit holes of the tubes are drawn at real size.
Los gráficos de los diámetros de los agujeros de salida de las boquillas son a tamaño real.
Les graphiques des diamètres des embouts de sortie des douilles sont en taille réelle.

- **1 Plain tube 0,4 cm**
1 Boquilla redonda 0,4 cm
1 Douille unie 0,4 cm
- ★ **1 Star tube 0,8 cm**
1 Boquilla estrella 0,8 cm
1 Douille cannelée 0,8 cm
- **1 Plain tube 0,8 cm**
1 Boquilla redonda 0,8 cm
1 Douille unie 0,8 cm
- ★ **1 Star tube 1,2 cm**
1 Boquilla estrella 1,2 cm
1 Douille cannelée 1,2 cm
- ✿ **1 Flower tube 1,1 cm**
1 Boquilla flor 1,1 cm
1 Douille fleur 1,1 cm
- 🌲 **1 Yule log 2 x 0,3 cm**
1 Boquilla cinta estrella 2 x 0,3 cm
1 Douille à bûche de Noël 2 x 0,3 cm

P821 Set of 6 tubes nr. 1 Conjunto de 6 boquillas n° 1 Boîte de 6 douilles num. 1



REF	1
P821000	1

Diameter exit holes of the tubes are drawn at real size.
Los gráficos de los diámetros de los agujeros de salida de las boquillas son a tamaño real.
Les graphiques des diamètres des embouts de sortie des douilles sont en taille réelle.

- **1 Plain tube 0,2 cm**
1 Boquilla redonda 0,2 cm
1 Douille unie 0,2 cm
- **1 Plain tube 0,4 cm**
1 Boquilla redonda 0,4 cm
1 Douille unie 0,4 cm
- **1 Plain tube 0,6 cm**
1 Boquilla redonda 0,6 cm
1 Douille unie 0,6 cm
- **1 Plain tube 0,8 cm**
1 Boquilla redonda 0,8 cm
1 Douille unie 0,8 cm
- **1 Plain tube 1 cm**
1 Boquilla redonda 1 cm
1 Douille unie 1 cm
- **1 Plain tube 1,2 cm**
1 Boquilla redonda 1,2 cm
1 Douille unie 1,2 cm

Bags and tubes 6.6

Mangas y boquillas
Poches et douilles



P822 Set of 6 tubes nr. 2 Conjunto de 6 boquillas n° 2 Boîte de 6 douilles num. 2



REF	1
P822000	1

Diameter exit holes of the tubes are drawn at real size.
Los gráficos de los diámetros de los agujeros de salida de las boquillas son a tamaño real.
Les graphiques des diamètres des embouts de sortie des douilles sont en taille réelle.

- ★ **1 Star tube 0,2 cm**
1 Boquilla estrella 0,2 cm
1 Douille cannelée 0,2 cm
- ★ **1 Star tube 0,4 cm**
1 Boquilla estrella 0,4 cm
1 Douille cannelée 0,4 cm
- ★ **1 Star tube 0,6 cm**
1 Boquilla estrella 0,6 cm
1 Douille cannelée 0,6 cm
- ★ **1 Star tube 0,8 cm**
1 Boquilla estrella 0,8 cm
1 Douille cannelée 0,8 cm
- ★ **1 Star tube 1 cm**
1 Boquilla estrella 1 cm
1 Douille cannelée 1 cm
- ★ **1 Star tube 1,2 cm**
1 Boquilla estrella 1,2 cm
1 Douille cannelée 1,2 cm

P822 Set of 6 tubes nr. 3 Conjunto de 6 boquillas n° 3 Boîte de 6 douilles num. 3



REF	1
P823000	1

Diameter exit holes of the tubes are drawn at real size.
Los gráficos de los diámetros de los agujeros de salida de las boquillas son a tamaño real.
Les graphiques des diamètres des embouts de sortie des douilles sont en taille réelle.

- ✿ **1 Closed flower tube 0,6 cm**
1 Boquilla flor cerrada 0,6 cm
1 Douille fleur fermée 0,6 cm
- ★ **1 Closed star tube 0,7 cm**
1 Boquilla estrella cerrada 0,7 cm
1 Douille cannelée fermée 0,7 cm
- ★ **1 Star tube 0,8 cm**
1 Boquilla estrella 0,8 cm
1 Douille cannelée 0,8 cm
- **1 Plain tube 1 cm**
1 Boquilla redonda 1 cm
1 Douille unie 1 cm
- ✿ **1 "Petits fours" tube 1,2 cm**
1 Boquilla rizada 1,2 cm
1 Douille à "petits fours" 1,2 cm
- ✿ **1 Flower tube 1,3 cm**
1 Boquilla flor 1,3 cm
1 Douille fleur 1,3 cm

P824 Set of 12 tubes nr. 4 Conjunto de 12 boquillas n° 4 Boîte de 12 douilles num. 4



REF	1
P824000	1

Diameter exit holes of the tubes are drawn at real size.
Los gráficos de los diámetros de los agujeros de salida de las boquillas son a tamaño real.
Les graphiques des diamètres des embouts de sortie des douilles sont en taille réelle.

- **1 Plain tube 0,6 cm**
1 Boquilla redonda 0,6 cm
1 Douille unie 0,6 cm
- **1 Plain tube 1 cm**
1 Boquilla redonda 1 cm
1 Douille unie 1 cm
- ★ **1 Star tube 0,8 cm**
1 Boquilla estrella 0,8 cm
1 Douille cannelée 0,8 cm
- ★ **1 Star tube 1,2 cm**
1 Boquilla estrella 1,2 cm
1 Douille cannelée 1,2 cm
- ★ **1 Closed star tube 0,7 mm**
1 Boquilla estrella cerrada 0,7 mm
1 Douille cannelée fermée 0,7 mm
- ★ **1 Closed star tube 1,1 mm**
1 Boquilla estrella cerrada 1,1 mm
1 Douille cannelée fermée 1,1 mm
- 🌲 **1 Yule log tube 2 mm**
1 Boquilla cinta estrella 2 mm
1 Douille à bûche de Noël 2 mm
- ★ **1 "Petits fours" tube 0,9 mm**
1 Boquilla rizada 0,9 mm
1 Douille à "petits fours" 0,9 mm
- ✿ **1 "Petits fours" tube 1,5 cm**
1 Boquilla rizada 1,5 cm
1 Douille à "petits fours" 1,5 cm
- ✿ **1 Flower tube 1,1 cm**
1 Boquilla flor 1,1 cm
1 Douille fleur 1,1 cm
- ✿ **1 Flower tube 1,5 cm**
1 Boquilla flor 1,5 cm
1 Douille fleur 1,5 cm
- ✿ **1 Closed flower tube 0,8 cm**
1 Boquilla flor cerrada 0,8 cm
1 Douille fleur fermée 0,8 cm

6.6 Bags and tubes

Mangas y boquillas
Poches et douilles



P853 Polycarbonate plain tube
Boquilla redonda de policarbonato
Douille unie en polycarbonate

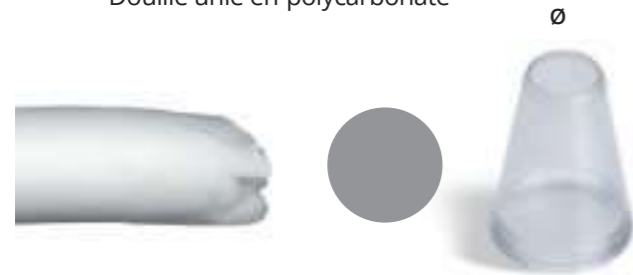

REF	Ø cm	Num.	
P853004	0,4	0	1
P853006	0,6	2	1
P853008	0,8	4	1
P853010	1,0	6	1
P853012	1,2	8	1
P853014	1,4	10	1

P854 Polycarbonate star tube
Boquilla estrella de policarbonato
Douille cannelée en polycarbonate



REF	Ø cm	Nº Teeth Nº Puntas Nº Dents	Num.	
P854006	0,6	7	2	1
P854008	0,8	7	4	1
P854010	1,0	7	6	1
P854012	1,2	7	8	1
P854014	1,4	8	10	1
P854016	1,6	8	12	1

P855 Set of 6 polycarbonate tubes n° 5
Conjunto de 6 boquillas de policarbonato n° 5
Boîte de 6 douilles en polycarbonate n° 5



Plain tube
Boquilla redonda
Douille unie

REF	
P855000	1

Nº 0	Nº 2	Nº 4	Nº 6	Nº 8	Nº 10
0,4 cm	0,6 cm	0,8 cm	1 cm	1,2 cm	1,4 cm



P857 Set of 12 polycarbonate tubes n° 12
Conjunto de 12 boquillas de policarbonato n° 12
Boîte de 12 douilles en polycarbonate n° 12



Plain tube
Boquilla redonda
Douille unie

Nº 0	Nº 2	Nº 4	Nº 6	Nº 8	Nº 10
0,4 cm	0,6 cm	0,8 cm	1 cm	1,2 cm	1,4 cm



P856 Set of 6 polycarbonate tubes n° 6
Conjunto de 6 boquillas de policarbonato n° 6
Boîte de 6 douilles en polycarbonate n° 6



Star tube
Boquilla estrella
Douille cannelée

REF	
P856000	1

Nº 2	Nº 4	Nº 6	Nº 8	Nº 10	Nº 12
0,6 cm	0,8 cm	1 cm	1,2 cm	1,4 cm	1,6 cm



REF	
P857000	1

Star tube
Boquilla estrella
Douille cannelée

Nº 2	Nº 4	Nº 6	Nº 8	Nº 10	Nº 12
0,6 cm	0,8 cm	1 cm	1,2 cm	1,4 cm	1,6 cm



Flexipan moulds 6.7

Moldes flexipan
Moules flexipan



FLEXIPAN® ORIGINE



The Flexipan® is a silicone and fibre glass combination mould suitable for the food contact.

This material combination gives to the piece solidity and an extraordinary durability, allied with exceptional non-stick properties either for cooking and freezing.

The Flexipan® does not require to be lubricated since their composition and flexibility allow an easy and fast release from the mould.

According to the use and the maintenance, the Flexipan®, enable us to use them between 2000 and 3000 times before the first signs of sticking arise.

The FLEXIPAN can be used to bake (+280 °C) or freeze (-40 °C) the most sweet and savoury products.

- ADVANTAGES FLEXIPAN®**
- No need to be greased for an easy and quick realise
 - Easy to clean
 - Between 2000 and 3000 times can be used
 - Professional pastry measures (60x40 cm)
 - Large range of moulds

El Flexipan® es una combinación de fibras de vidrio y sílicona adecuadas para el uso alimentario.

Esta combinación de materiales le da a la pieza una solidez y duración de vida inigualables, así como propiedades anti-adherentes excepcionales tanto en cocción como en congelación.

El Flexipan® no requiere ser engrasado ya que su composición y flexibilidad permiten un desmoldeo fácil y rápido.

El Flexipan® con un uso y trato correctos nos permite realizar entre 2.000 y 3.000 cocciones antes de empezar a notar los primeros signos de deterioro.

El Flexipan® permite realizar cualquier tipo de preparaciones dulces o saladas, tanto en cocción (+280 °C) como en congelación (-40 °C).

- VENTAJAS FLEXIPAN®**
- No es necesario engrasar los moldes para obtener un desmoldeo perfecto
 - Gran facilidad para el desmoldeo de piezas congeladas
 - La limpieza de los moldes se realiza de una manera fácil y rápida
 - Larga vida de la pieza (2.000-3.000 cocciones)
 - Medidas para pastelería profesional (60x40 cm)
 - Gama completa de formas.

Le Flexipan® est une combinaison de tissus de verre et silicines adéquats pour l'utilisation alimentaire.

Cette combinaison de matériels donne au moule une solidité et une durabilité extraordinaire, alliées à des propriétés anti-adhérentes exceptionnelles tant en cuisson comme en congélation.

Le Flexipan® n'a pas besoin d'être lubrifié puisque sa composition et flexibilité permettent un démolage facile et rapide.

Selon l'utilisation et l'entretien des moules, le Flexipan®, nous permet d'effectuer entre 2.000 et 3.000 cuissons avant de noter les premiers signes de collage.

Le Flexipan® permet d'effectuer tous types de préparations sucrées ou salées, en cuisson (+ 280 °C) ou en congélation (-40 °C).

- AVANTAGES FLEXIPAN®**
- Ne précise d'aucun graissage pour un démolage facile et rapide
 - Facile à nettoyer
 - De 2000 à 3000 cuissons par moule
 - Mesures pour la pâtisserie professionnelle (60x40 cm)
 - Large gamme de moules

Sizes
Medidas
Mesures

Pastry / Pastelería /
Pâtisserie

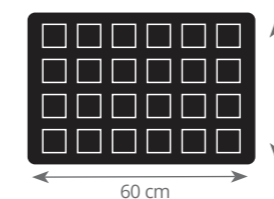

-40 °C / -104 °F
+280 °C / +539 °F



H.A.C.C.P.
NO PROBLEM

6.7 Flexipan moulds

Moldes flexipan
Moules flexipan

Si
Silicone

Cones / Conos / Cones



REF	Forma	Fig	Ø cm	H cm	ml	
P859134		40	5	4	24	1
P859135		20	7	6	80	1

Rosace shape / Bavaois / Bavaois



REF	Forma	Fig	Ø cm	H cm	ml	
P859139		18	7,8	3,5	100	1

Charlottes

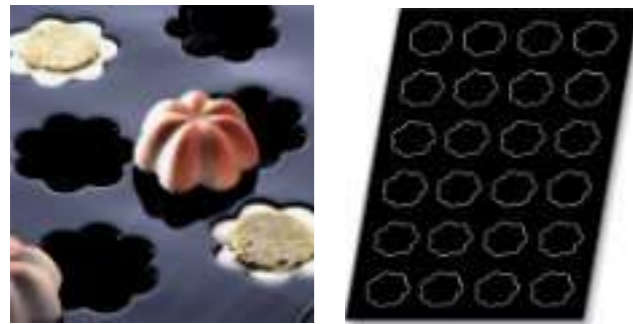

REF	Forma	Fig	Ø cm	H cm	ml	
P859141		24	6,2	3,5	60	1
P859113		18	7,8	4,0	100	1

Madeleines/ Magdalenas / Madeleines



REF	Forma	Fig	cm	H cm	ml	
P859142		56	5,2 x 3,3	1,5	15	1
P859115		40	7,8 x 4,7	1,9	35	1

Saint Jacques shell / Conchas / Coquilles Saint-Jacques

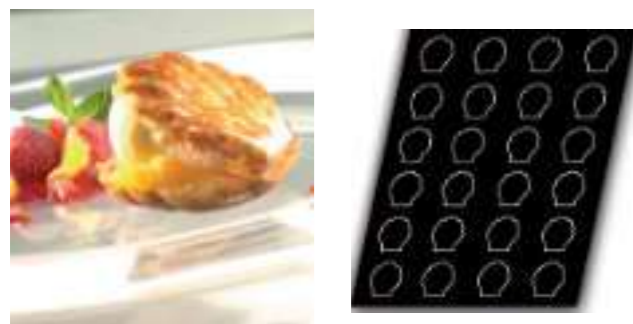

REF	Forma	Fig	cm	H cm	ml	
P859132		24	8 x 7,5	2	70	1

Deep flower / Margaritas / Marguerites en relief

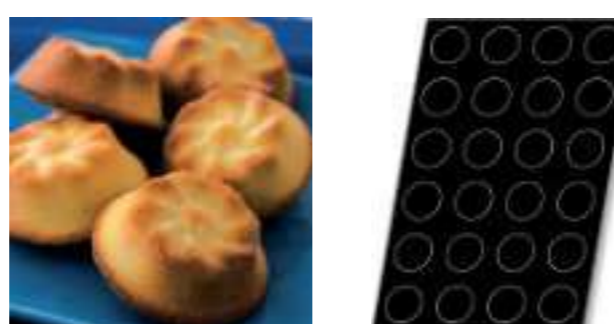

REF	Forma	Fig	Ø cm	H cm	ml	
P859143		24	2,4	7	70	1

Flexipan moulds 6.7

Moldes flexipan
Moules flexipan

Si
Silicone

Flowers / Flores / Fleurs



REF	Forma	Fig	Ø cm	H cm	ml	
P859144		24	7,8	2	80	1

Pyramids / Pirámides / Pyramides

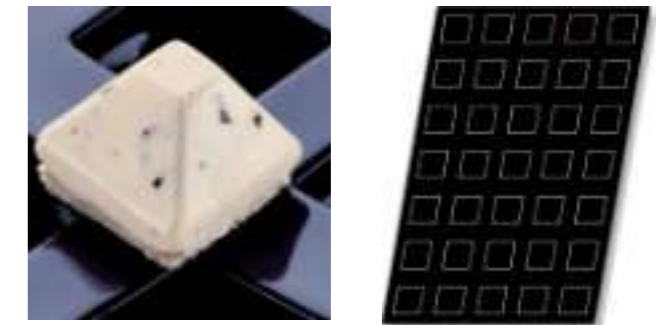

REF	Forma	Fig	cm	H cm	ml	
P859109		54	3,5 x 3,5	2,3	15	1
P859111		35	5,0 x 5,0	3,5	35	1
P859110		24	7,1 x 7,1	4,1	90	1

Half-spheres / Semi-esferas / Demi-sphères



REF	Forma	Fig	Ø cm	H cm	ml	
P859151		96	2,6	1,6	6	1
P859105		70	2,9	1,8	10	1
P859103		48	4,2	2,1	20	1
P859102		28	5,8	3,1	50	1
P859101		24	7,0	4,0	105	1
P859104		24	8,0	4,0	126	1

Half-spheres upside down / Semi-esferas invertidas / Demi-sphères inversées



REF	Forma	Fig	Ø cm	H cm	ml	
P859150		45	2,6	1,6	6	1

Squares / Cuadrados / Carrés



REF	Forma	Fig	cm	H cm	ml	
P859152		60	3,7 x 3,7	1,7	18	1
P859153		35	5,6 x 5,6	2,4	60	1

Square tartlet / Tartaletas cuadradas / Tartelettes carrées

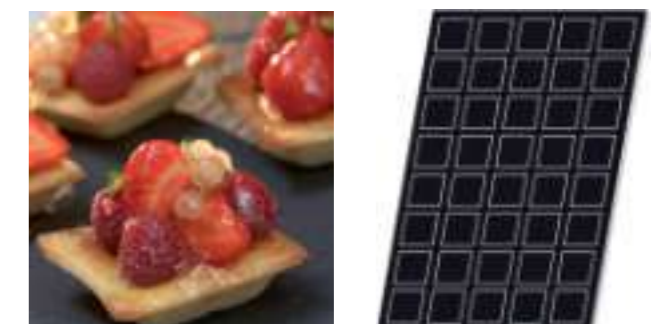

REF	Forma	Fig	cm	H cm	ml	
P859154		60	4,5 x 4,5	1,2	20	1
P859155		40	6,0 x 6,0	1,5	40	1

6.7 Flexipan moulds

Moldes flexipan
Moules flexipan



Square savarins / Savarins cuadradas / Savarins carrées



REF	Forma	Fig	cm	H cm	ml	
P859156		60	3,7 x 3,7	1,7	15	1
P859157		35	5,6 x 5,6	2,4	45	1
P859158		24	7,0 x 7,0	3,0	100	1

Round savarins / Savarins redondos / Savarins ronds



REF	Forma	Fig	Ø cm	H cm	ml	
P859159		60	4,1	1,2	10	1
P859124		35	6,6	2,0	50	1
P859219		24	7,0	2,3	65	1
P859122		24	8,0	2,0	70	1

Oval savarins / Savarins ovalados / Savarins ovales



REF	Forma	Fig	cm	H cm	ml	
P859123		24	8 x 6	2,5	70	1

Oval / Óvalos / Ovales

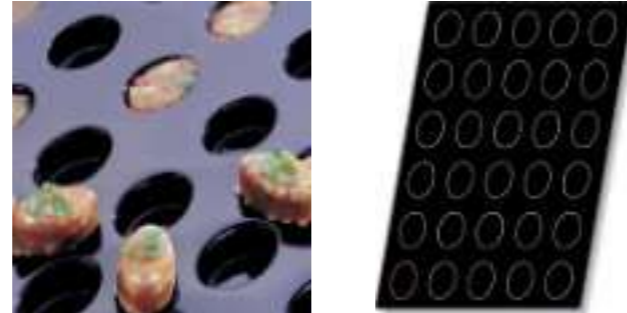

REF	Forma	Fig	cm	H cm	ml	
P859167		30	7,0 x 5,0	3	25	1
P859130		30	8,5 x 6,0	3	100	1

Round tartlets / Tartaletas redondas / Tartelettes ronds



REF	Forma	Fig	Ø cm	H cm	ml	
P859114		60	42	10,0	13	1
P859171		48	48	15,0	20	1
P859172		40	58	20,0	35	1
P859126		24	77	20,0	65	1

Logs / Troncos / Bûche

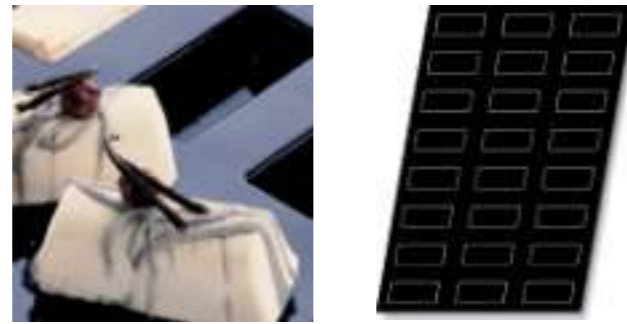

REF	Forma	Fig	cm	H cm	ml	
P859125		24	9,50 x 4	3,0	80	1
P859184		8	33,9 x 4	3,9	450	1
P859185		5	49,5 x 4	3,9	700	1

Flexipan moulds 6.7

Moldes flexipan
Moules flexipan



Cakes-Lady fingers / Cakes/Bizcochos / Cakes-Coudoirs



REF	Forma	Fig	cm	H cm	ml	
P859186		120	4,0 x 1,5	1,2	6	1

Lingots / Lingotes / Lingots

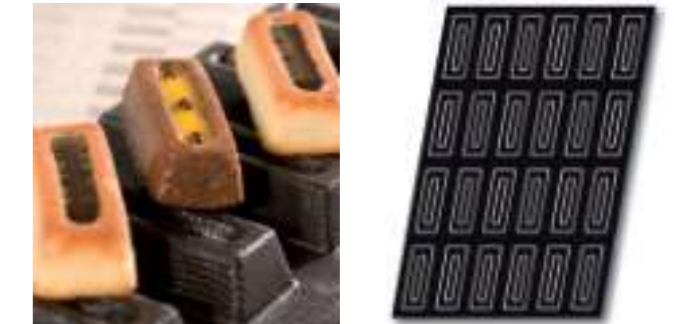

REF	Forma	Fig	cm	H cm	ml	
P859189		24	10 x 4	2,5	70	1
P859190		24	12 x 4	2,5	90	1

Half-Cylindres / Semi-cilindros / Demi-cylindres



REF	Forma	Fig	cm	H cm	ml	
P859191		48	8,5 x 1,7	1,5	20	1

Cakes

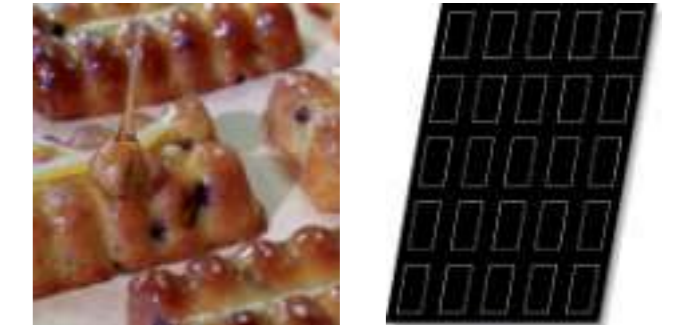

REF	Forma	Fig	cm	H cm	ml	
P859192		24	8 x 3	3,0	55	1
P859195		16	11 x 6	2,5	105	1

Financiers



REF	Forma	Fig	cm	H cm	ml	
P859196		84	5,0 x 2,6	11	10	1
P859197		24	8,6 x 4,6	14	45	1

Muffins



REF	Forma	Fig	Ø cm	H cm	ml	
P859106		40	5,1	2,9	45	1
P859107		24	7,3	4,0	125	1
P859198		15	8,2	5,0	220	1

6.7 Flexipan moulds

Moldes flexipan
Moules flexipan

Si
Silicone

Cylinders / Cilindros / Cylindres



REF	Forma	Fig	Ø cm	H cm	ml	
P859206		48	4,0	2,0	25	1
P859207		24	6,3	2,5	65	1
P859117		24	6,3	3,5	90	1

Florentiners / Florentina / Florentins

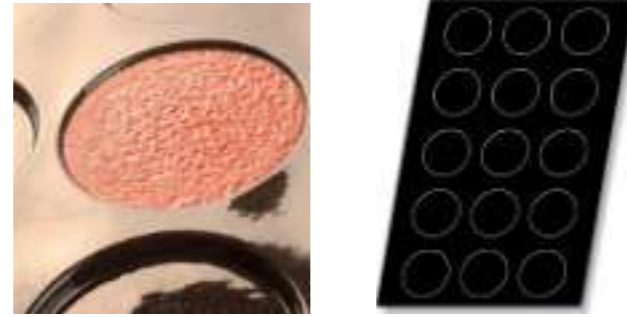

REF	Forma	Fig	Ø cm	H cm	ml	
P859129		15	10,2	2	140	1

Tatin apple tarts / Tartas tatin / Tartes tatin

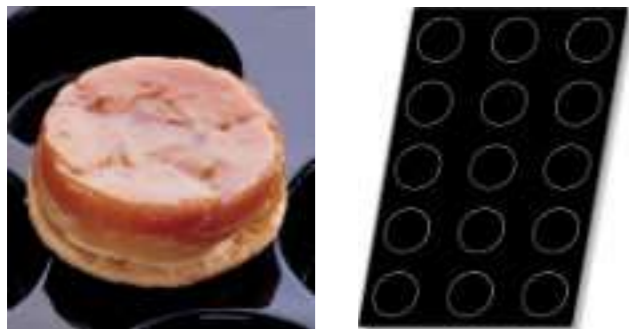

REF	Forma	Fig	Ø cm	H cm	ml	
P859210		15	8,20	3,0	135	1
P859211		12	10,0	3,5	245	1
P859212		12	10,5	4,0	305	1

Round-Pizza-Quiches / Entremets-Pizzas-Quiches / Empreintes rondes-Pizza-Quiches



REF	Forma	Fig	Ø cm	H cm	ml	
P859116		6	18,6	1,2	300	1

Mini-brioches / Lanzaderas / Navettes



REF	Forma	Fig	cm	H cm	ml	
P859200		48	7 x 3	1	15	1

Long / Alargadas / Longues



REF	Forma	Fig	cm	H cm	ml	
P859201		24	13 x 4,8	1,8	80	1

Si
Silicone

Flexipan moulds 6.7

Moldes flexipan
Moules flexipan

Rounds / Redondas / Ronds



REF	Forma	Fig	Ø cm	H cm	ml	
P859202		24	7,9	1,5	65	1

Flowers / Flores / Fleurs



REF	Forma	Fig	cm	H cm	ml	
P859203		24	6,2 x 4,9	2,6	60	1

Cannelées / Acanalda

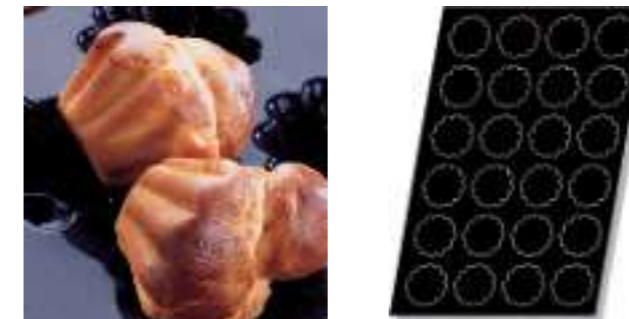

REF	Forma	Fig	Ø cm	H cm	ml	
P859204		24	6,8	2,5	60	1
P859205		24	7,8	3,0	105	1

Octagons / Octágonos / Octogones



REF	Forma	Fig	Ø cm	H cm	ml	
P859119		40	4,3 x 4	2,6	28	1

Pomponnettes



REF	Forma	Fig	Ø cm	H cm	ml	
P859120		96	3,6	1,7	14	1

6.8 Siliconemoulds

Moldes silicona
Moules silicone



P8504 Cake mould
Molde cake
Moule à cake



REF	W x D x H cm	
P850424	24 x 10,5 x 6,5	1
P850426	26 x 10 x 7	1

P8502 Gugelhoph
Molde savarin alto
Moule savarin haut



New shape
Nueva forma
Nouvelle forme

REF	Ø cm	H cm	
P850222	22,5	11,5	12

P8501 High cake mould
Molde tarta
Manqué rond uni



REF	Ø cm	H cm	
P850124	24	4,2	1
P850128	28	4,7	1

P8505 Round tart mould with fluted edges
Molde rizado para tarta
Tourtière ronde avec bord cannelé



New shape
Nueva forma
Nouvelle forme

REF	Ø cm	H cm	
P850528	28	3	12

Medidas
Sizes
Mesures

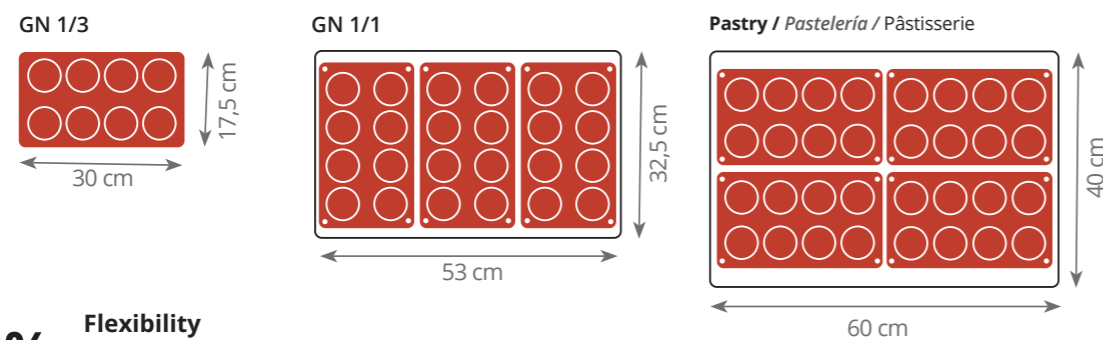

Si Silicone
100% Flexibility
Flexibilidad
Flexibilité

IDEA! Ideal for freezing. It can also be used for all preparations of cakes, chocolates, petit-fours, and catering preparations.
Ideal para congelador. Puede ser utilizado para preparar todo tipo de pequeña repostería, galletas o chocolates.
Idéal pour la congélation. Utilisable pour tout type de préparations de cakes, chocolats, petits fours, et préparations traiteurs.

-60 °C / - 140 °F
+230 °C / + 446 °F



H.A.C.C.P.
NO PROBLEM

Siliconemoulds 6.8

Moldes silicona
Moules silicone



REF	Fig	Ø cm	H cm	
P850001	5	8	4	1
P850002	6	7	3,5	1
P850003	8	6	3	1
P850004	15	5	2,5	12

REF	Fig	Ø cm	H cm	
P850005	15	4	2	1
P850006	24	3	1,5	12
P850007	6	7,1 x 7,1	4	1
P850012	6	7,2	2,3	1

REF	Fig	cm	H cm	
P850017	24	3	1,5	1
P850018	9	7x5	2	1
P850022	11	5	2,8	1
P850023	6	7	3,7	12

REF	Fig	Ø cm	H cm	
P850024	5	8	3,5	1
P850025	20	4,9 x 2,6	11	1
P850026	12	8 x 3	3	1
P850027	15	4	2	1

REF	Fig	Ø cm	H cm	
P850028	8	6	3,5	1
P850031	20	3,8 x 3	1	1
P850033	18	3,5	3,5	1

6.8 Silicone moulds

Moldes silicona
Moules silicone



Silicone moulds 600 x 400 mm. Possible to divide in two of 300 x 200 mm thanks to its symmetrical design
Moldes de silicona 600 x 400 mm Ofrecen la posibilidad de dividirlos en 2 moldes de 300 x 200 mm gracias a su diseño simétrico
Moules en silicone 600 x 400 mm avec possibilité de diviser en deux moules de 300 x 200 mm grâce à sa symétrie

P859900 Mini-cakes



600 x 400 mm

Ref	Fig	cm1	cm2	H cm	
P859900	20	10 x 5	8 x 3	30	1

P859901 Briochette



600 x 400 mm

Ref	Fig	Ø cm	H cm	
P859901	24	7,9	3,7	1

P859902 Half-spheres Semi-esferas Demi-sphères



600 x 400 mm

Ref	Fig	Ø cm	H cm	
P859902	24	7	3,5	1

P859903 Muffin



600 x 400 mm

Ref	Fig	Ø cm	H cm	
P859903	24	7	4,2	1

P859904 Mini muffin



600 x 400 mm

Ref	Fig	Ø cm	H cm	
P859904	20	5	2,8	1

P859905 Gugelhopf



600 x 400 mm

Ref	Fig	Ø cm	H cm	
P859905	24	7	3,6	1

Siliconemoulds 6.8

Moldes silicona
Moules silicone



P859907 Mini madeleines Mini madalenas Mini madeleines



600 x 400 mm

REF	Fig	Ø cm	H cm	
P859907	84	4,2 x 3	1,1	1

P859908 Tartalets Tartaletas Tartalettes



600 x 400 mm

REF	Fig	Ø cm	H cm	
P859908	60	5	1,5	1

P859909 Cannelés Canalados



600 x 400 mm

REF	Fig	Ø cm	H cm	
P859909	60	8,5	5	1

P859910 Pyramids Piramides Pyramides



600 x 400 mm

REF	Fig	cm	H cm	
P859910	30	7,1 x 7,1	4	1

P859911 Florentiners Florentinas Florentins



600 x 400 mm

REF	Fig	Ø cm	H cm	
P859911	40	5,5	1,2	1

7 Gastronorm containers

Cubetas gastronorm
Bacs gastronorme





7.1  **GN PRO** 194
18/10 ST/STEEL
INOX 18/10

7.2  **GASTRONORM ACCESSORIES** 198
COMPLEMENTOS GASTRONORM
ACCESSOIRES GASTRONORME

7.3  **WITH SANDWICH BOTTOM** 199
CON FONDO DIFUSOR
AVEC FOND THERMO-DIFFUSEUR

7.4  **SUPERPAN 3** 200

7.5  **POLYCARBONATE** 202
POLICARBONATO
POLYCARBONATE

7.6  **BISPHENOL-A FREE** 204
SIN BISFENOL-A
SANS BISPHÉNOL-A

7.7  **POLYPROPYLENE** 206
POLIPROPILENO
POLYPROPYLÈNE

7.8  **VIOLET COLLECTION** 208

GN CONTAINERS
CUBETAS GN
BACS GN

Gastronorm containers

Cubetas gastronorm
Bacs gastronorme

According to en-631.2 Pujadas offers one of the most specialized ranges, in-house manufacturing, of gastronorm containers in the market.

Conforme a la norma en-631.2 Pujadas ofrece una de las gamas de cubetas gastronorm de fabricación propia más amplia del mercado.

Suivant la norme en-631.2 Pujadas propose une des gammes de bacs gastronorm de propre fabrication des plus spécialisés du marché.

Stainless Steel Acero Inoxidable Acier Inox

18/10



Reinforced edges
Bordes reforzados
Bords renforcés

Radii specially designed for: + capacity + cleaning
Geometría adaptada: + limpieza + capacidad
Géométrie adaptée: + propreté + capacité

Polycarbonate Policarbonato Polycarbonate

- 40 °C
+ 130 °C

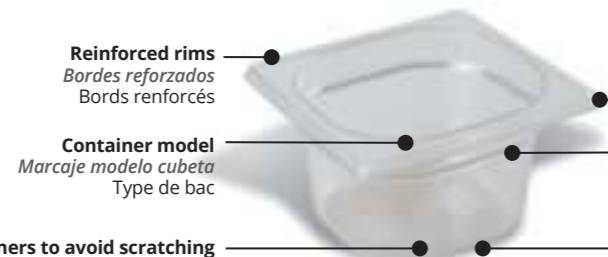

Reinforced rims
Bordes reforzados
Bords renforcés

Container model
Marcaje modelo cubeta
Type de bac

Texturing corners to avoid scratching
Textura para evitar rayadas
Côtés granités pour éviter rayures

Thicker
Mayor grosor
Plus épais

Graduations marked externally
Graduación externa de capacidad
Échelle de graduations à l'extérieur

Main features marked on the base
Características marcadas en el fondo
Caractéristiques marqués au fond

Bisphenol-A free Sin bisfenol-A Sans bisphénol-A

- 40 °C
+ 90 °C



Containers made of copolyester without Bisphenol-A (100% BPA FREE).
Cubetas en copoliéster sin Bisfenol-A (100% BPA FREE)
Bacs en copolyester sans Bisphénol-A (100% BPA FREE)

Polypropylene Polipropileno Polypropylène

- 40 °C
+ 110 °C

Hermetic with Polinorm Lid
Hermético con tapa Polinorm
Hermetique avec couvercle Polinorm

Reinforced rims
Bordes reforzados
Bords renforcés

Container model
Marcaje modelo cubeta
Type de bac

Texturing corners to avoid scratching
Textura para evitar rayadas
Côtés granités pour éviter rayures



Thicker
Mayor grosor
Plus épais

Graduations marked externally
Graduación externa de capacidad
Échelle de graduations à l'extérieur

Main features marked on the base
Características marcadas en el fondo
Caractéristiques marqués au fond

Gastronorm containers

Cubetas gastronorm
Bacs gastronorme

Cooking Cocción Cuisson

PATENTED EXCLUSIVE



GN Pan with sandwich base
GN con fondo difusor
Bac GN avec fond thermo-diffuseur



Non-stick aluminium GN pan
GN aluminio antiadherente
Bac GN anti-adhésif en aluminium



Special Oven GN pans
Bandejas GN especial horno
PLAQUES spéciales GN pour four

Transport Transporte Transport



St/Steel GN + St/Steel hermetic lid
GN Inox + Tapa inox hermética
Bac GN Inox + Couvercle étanche inox

TEMP. 120°C
HERMÉTICO / HERMETIC / ÉTANCHE



Polycarbonate or BPA free + Polinorm lid
Policarbonato o cubeta sin Bisfenol-A + tapa polinorm
Polycarbonate ou sans BPA + couvercle Polinorm

TEMP. 100°C



Polypropylene + Polinorm lid
GN Polipropileno + Tapa Polinorm®
GN Polypropylène + Couvercle Polinorm®

TEMP. 90°C

Storage Almacenamiento Stockage



Polycarbonate GN + Polycarbonate Lid
GN Polycarbonato + Tapa polycarbonato
GN Polycarbonate + Couvercle Polycarbonate



Polycarbonate GN + Polinorm lid
GN Polycarbonato + Tapa Polinorm®
Polycarbonate + Couvercle Polinorm®



Polypropylene + Polinorm lid
GN Polipropileno + Tapa Polinorm®
GN Polypropylène + Couvercle Polinorm®

VIOLET
COLLECTION



Allergen-Free
Antialérgico
Anti allergique

Display Presentación Présentation



Polycarbonate GN + Polycarbonate Lid
GN Polycarbonato + Tapa polycarbonato
GN Polycarbonate + Couvercle Polycarbonate



St/Steel GN with sandwich base + Polycarbonate Lid
GN Inox con fondo Difusor + Tapa polycarbonato
GN Inox avec fond thermo-diffuseur + Polycarbonate



Melamine GN
GN Melamina
GN mélamine

See products on
Ver productos en
Voir produits en page

P. 380

GNcontainers selection

Selección cubetas gastronorm
Selectionbacs gastronorme

18/10St/steel
Inox 18/10
Inox 18/10

18/10St/steel sandwich bottom
Inox 18/10fondo difusor
Inox 18/10fond thermo-diffuseur

Non-stick aluminium
Aluminio antiadherente
Aluminium anti-adhésif

Polycarbonate
Policarbonato
Polycarbonate

Bisphenol-A free
Sin bisfenol-A
Sans bisphénol-A

Polypropylene
Polipropileno
Polypropylène

Melamine*
Melamine*
Mélamine*



P. 194



P. 199



P. 401



P. 89



P. 202



P. 204



P. 206

VIOLET
COLLECTION



P. 374

APPEARANCE
PRESENTACIÓN
PRÉSENTATION



ROBUSNESS
RESISTENCIA
ROBUSTESSE



STORAGE
ALMACENAMIENTO
STOCKAGE



BAIN MARIE
BAÑO-MARIA
BAIN-MARIE



TEMPERATURE MAX
TEMPERATURA MAX
TEMPÉRATURE MAX.



130 °C

90 °C

110 °C

70 °C

OVEN
HORNO
FOUR



130 °C

MICRO-WAVE
MICROONDAS
MICRO-ONDES



COOKING
COCCIÓN
CUISSON



INDUCTION
INDUCCIÓN
INDUCTION



INDUCTION



INDUCTION

WARM TRANSPORTATION
TRANSPORTE EN CALIENTE
TRANSPORT CHAUD



130 °C

80 °C

70 °C

POLINORM LID
TAPA POLINORM
COUVERCLE POLINORM



✓ **RECOMMENDED** / RECOMENDADO / RECOMMANDÉ

● **SUITABLE** / ACEPTABLE / ACCEPTABLE

* HUMID ENVIRONMENT / AMBIENTE HÚMEDO / ENVIRONNEMENT HUMIDE

GN CONTAINERS
CUBETAS GN
BACS GN

GN CONTAINERS
CUBETAS GN
BACS GN

Sizes and combinations

Medidas y combinaciones

Mesures et combinaisons



Fitting measures / Medidas de encaje / Mesures d'emboîtement

Modelo	"A"	"B"
2/1	630	510
1/1	510	305
2/3	333	305
1/2	305	245
1/3	305	155
1/4	245	142
1/6	156	142
1/9	156	88

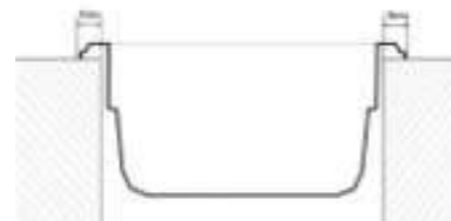
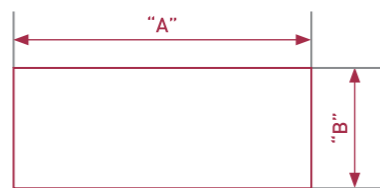

GN polynorm® lid

Tapa GN polinorm®
GN couvercle polynorm®

PATENTED EXCLUSIVE



Not for SP3 range.
No aptas para la gama SP3.
Pas pour la gamme SP3.



AVAILABLE IN SIX COLOURS
DISPONIBLE EN SEIS COLORES
DISPONIBLE EN SIX COULEURS



P6 Available for 1/1, 1/2, 1/3 and 1/6
Disponible para 1/1, 1/2, 1/3 y 1/6
Disponible pour 1/1, 1/2, 1/3 et 1/6



ADJUSTABLES TO / ADAPTABLES A / ADAPTABLE À

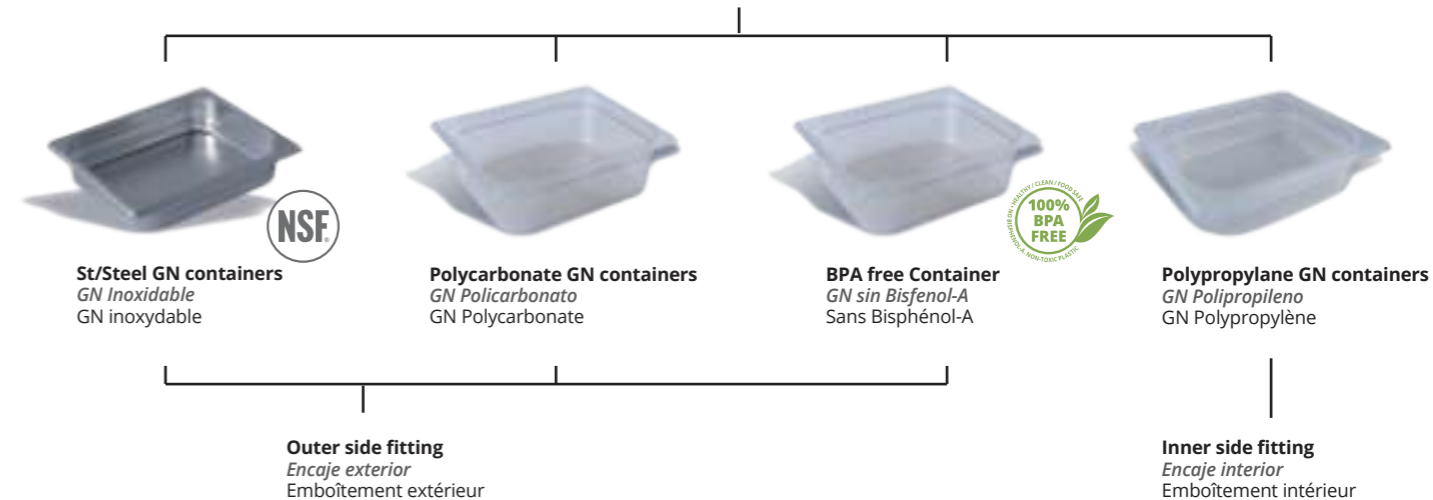

Flaps to fit with GN inox and PC

Clips para cierre cubeta inox y PC
Rainures pour clipser bacs GN inox et PC

Polinorm Lid
Tapa Polinorm
Couvercle Polinorm

Steel container / Polycarbonate
Cubeta inox / Policarbonato
Bac inox / Polycarbonate

Polinorm Lid
Tapa Polinorm
Couvercle Polinorm

Hermetic for PP containers
Cierre hermético para cubetas de PP
Hermetique sur bacs PP

Container polypropylene
Cubeta polipropileno
Bac polypropylène

7.1 GN PRO

18/10St/steel Gastronorm
Gastronorm inox 18/10



18/10
Stainless steel

2/1 650 x 530 mm



REF	H mm	Lts	
P210201	20	6,2	6
P210401	40	11,5	6
P210651	65	18,8	6
P211001	100	28,9	6
P211501	150	43,1	3
P212001	200	52,0	3

1/1 530 x 325 mm



REF	H mm	Lts	
P110101	10	1,25	6 NEW
P110201	20	2,80	6
P110401	40	5,10	6
P110551	55	7,00	6
P110651	65	8,30	6
P111001	100	14,20	6
P111501	150	20,20	6
P112001	200	26,00	6

2/3 353 x 325 mm



REF	H mm	Lts	
P230101	10	1,5	6 NEW
P230201	20	1,7	6
P230401	40	3,1	6
P230651	65	5,6	6
P231001	100	8,8	6
P231501	150	13,2	6
P232001	200	18,3	6

1/2 325 x 265 mm



REF	H mm	Lts	
P120101	10	1,0	6 NEW
P120201	20	1,2	6
P120401	40	2,2	6
P120651	65	4,1	6
P121001	100	6,1	6
P121501	150	9,1	6
P122001	200	12,0	6

2/4 530 x 162 mm



REF	H mm	Lts	
P240401	40	1,80	12
P240651	65	4,00	6
P241001	100	6,00	6
P241501	150	10,00	6

1/3 325 x 176 mm



REF	H mm	Lts	
P130201	20	0,8	6
P130401*	40	1,5	6
P130651	65	2,5	6
P131001	100	3,8	6
P131501	150	5,6	6
P132001	200	7,3	6



* Special GN container for snack showcases.
* Cubeta GN especial para vitrinas mostrador snack.
* Bac GN spécial pour vitrines snack.

GN PRO 7.1

18/10St/steel Gastronorm
Gastronorm inox 18/10

18/10
Stainless steel



1/4 265 x 162 mm



REF	H mm	Lts	
P140201	20	0,5	6
P140651	65	1,7	6
P141001	100	2,8	6
P141501	150	4,1	6
P142001	200	5,0	6

1/6 176 x 162 mm



REF	H mm	Lts	
P160651	65	1,0	6
P161001	100	1,6	6
P161501	150	2,2	6
P162001	200	2,9	6

1/9 176 x 108 mm



REF	H mm	Lts	
P190651	65	0,6	6
P191001	100	0,8	6

Falling handles

Asas móviles
Anses tombantes



Suitable for all GN sizes
Apta para todas las medidas de cubetas
Apte sur toutes les dimensions GN

1

Fixed handles

Asas fijas
Anses fixes

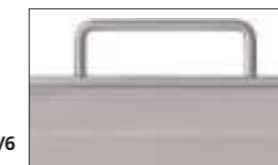

Only for containers 1/2, 1/3, 1/4 and 1/6
Sólo para cubetas 1/2, 1/3, 1/4 y 1/6
Seulement pour bacs 1/2, 1/3, 1/4 et 1/6

1

Perforated bottoms for containers

Fondos perforados para cubetas
Egouttoirs pour bacs



Adjustable to SP3 upto 100 mm depth
Aptos para cubetas SP3 hasta 100 mm de profundidad
Adaptables à bacs SP3 jusqu'à 100 mm profondeur

REF	Mod	
P215000	2/1	1
P115000	1/1	1
P235000	2/3	1
P125000	1/2	1
P135000	1/3	1
P145000	1/4	1

Adaptable bars

Perfiles divisorios
Barrettes de composition



To arrange any composition with gastronorm containers.
Para realizar cualquier composición con las cubetas gastronorm.
Pour réaliser toute composition avec les bacs gastronorme.

REF	H mm	L cm	
P111111	1/1	53,0	1
P122222	1/2	32,5	1

7.1 GN PRO

18/10St/steel Gastronorm
Gastronorm inox 18/10



18/10
Stainless steel

2/1 650 x 530 mm



REF	H mm	
P210202	20*	6
P210402	40*	6
P210652	65*	6
P211002	100**	6
P211502	150**	3
P212002	200**	3

1/1 530 x 325 mm



REF	H mm	
P110202	20*	6
P110402	40*	6
P110552	55*	6
P110652	65*	6
P111002	100**	6
P111502	150**	6
P112002	200**	6

2/3 353 x 325 mm



REF	H mm	
P230202	20*	6
P230402	40*	6
P230652	65*	6
P231002	100**	6
P231502	150**	6
P232002	200**	6

1/2 325 x 265 mm



REF	H mm	
P120652	65*	6
P121002	100**	6
P121502	150**	6
P122002	200**	6

1/3 325 x 176 mm



REF	H mm	
P130202	20*	6
P130402	40*	6
P130652	65*	6
P131002	100**	6
P131502	150**	6
P132002	200**	6

*Perforated bottom.
*Fondo perforado.
*Fond perforé.

**Perforated bottom and sides.
**Fondo y laterales perforados.
**Fonds et latéraux perforés.

GN PRO 7.1

18/10St/steel Gastronorm
Gastronorm inox 18/10

18/10
Stainless steel



Easy Open hermetic lid Tapa hermética Easy Open Couvercle hermétique Easy Open



NEW!

* Lug for easy opening
Tirador para fácil apertura
Poignée pour une ouverture facile

Silicone gasket for hermetic closure
Junta de silicona para cierre hermético
Joint en silicone pour fermeture hermétique

REF	Mod	
P110004EO*	1/1	1
P120004EO	1/2	1

Hermetic lid Tapa hermética Couvercle étanche



Silicone joint
Detalle silicona
Joint silicone

REF	Mod	
P110004	1/1	1
P120004	1/2	1
P130004	1/3	1
P140004	1/4	1
P160004	1/6	1

Polinorm® Lid Tapa Polinorm® Couvercle Polinorm®

PATENTED EXCLUSIVE



REF	Mod	
P1100 + COLOR	1/1	30
P1200 + COLOR	1/2	60
P1300 + COLOR	1/3	30
P1400 + COLOR	1/4	30
P1600 + COLOR	1/6	60
P1900 + COLOR	1/9	60

Lid Tapa Couvercle



REF	Mod	
P110000	1/1	1
P230000	2/3	1
P120000	1/2	1
P130000	1/3	1
P140000	1/4	1
P160000	1/6	1
P190000	1/9	1

Flat lid without handle Tapa plana sin asa Couvercle plat sans anse



REF	Mod	
P110005	1/1	1
P120005	1/2	1

Ref. colour lid
Ref. color tapa
Ref. couleur couvercle

- P1 P2 P3 P4 P5
- P6 Available for 1/1, 1/2, 1/3 and 1/6
Disponibile para 1/1, 1/2, 1/3 y 1/6
Disponible pour 1/1, 1/2, 1/3 et 1/6

St/Steel, PC, Bisphenol-A FREE and PP GN containers.
Not for SP3 range.

Cubetas GN inox, PC, sin Bisfenol-A y PP.
No aptas para la gama SP3.

Bacs GN inox, PC, sans Bisphénol-A et PP.
Pas pour la gamme SP3.

7.2 Gastronorm accessories

Complementos gastronorm
Accessoires gastronorme



Attach the lid, aluminium foil or cling film to the tray for secure transport or storage. Dishwasher safe. Easy to use.

Fija la tapa, el papel de aluminio o el papel film, a la cubeta, para un transporte y almacenamiento seguro. Apta para lavavajillas. Fácil de usar.

Fixe le couvercle, le papier d'aluminium ou le film alimentaire au bac pour transport et stockage de façon sûre. Va au lave-vaisselle. Facile à utiliser.

N-0001B GN Pan Band. Black
Banda selladora silicona GN. Negra
Bande à silicone GN. Noir



PATENTED EXCLUSIVE

+232,2°C



REF	type / tipo	
N-0001B	1/1	24
N-0002B	1/2	24
N-0003B	1/3	24
N-0006B	1/6	24

P100004P Stand for GN containers

Presentador cubetas GN
Support pour bacs GN



REF		
P100004P	Only stand / Soporte solo / Support seul	1

REF	Set / Conjunto / Lot	
P100005P	6 - GN 1/9 65 mm	1
P100006P	6 - GN 1/9 100 mm	1
P100008P	4 - GN 1/6 100 mm	1

It can contain / Permiten sostener / Il peut contenir



Adjustable to GN container in polycarbonate and polypropylene
Adaptable a cubetas GN policarbonato y polipropileno
Adapté à bacs GN en polycarbonate et polypropylène

P100003P Stand for GN lids

Soporte para tapas GN
Support pour couvercles GN

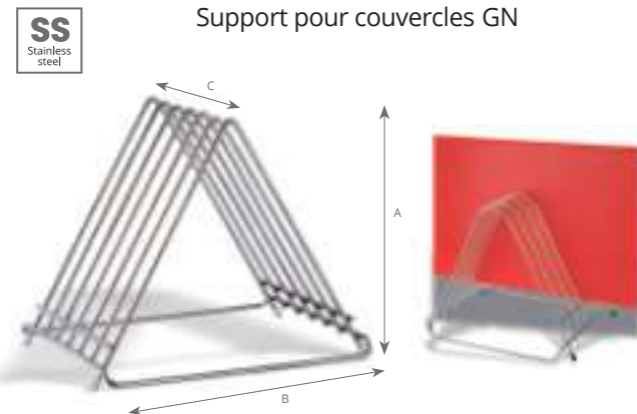

For 6 lids
Para 6 tapas
Pour 6 couvercles

Distance between wires 2,5 cm
Distancia entre varillas 2,5 cm
Distance entre fils 2,5 cm

IDEA! Perfect for cutting boards. Refer to page 138-140
Ideal para tablas de corte. Ver página 138-140
Idéal pour planches à découper. Voir page 138-140

REF	A cm	B cm	C cm	
P100003P	27	31	27	1

With sandwich bottom 7.3

Con fondo difusor
Avec fond thermo-diffuseur



INDUCTION

PATENTED EXCLUSIVE

GN containers with sandwich base, suitable for cooking directly on any kind of stoves including induction.

Cubetas GN con fondo difusor: únicas, adaptadas a la cocción en placas de inducción mediante fondo sandwich (inox-alu-inox).

Bacs GN avec fond thermo-diffuseur apte sur tout type de cuisinières, surtout en induction.

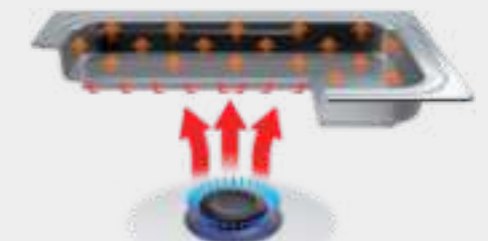

Sandwich bottom GN container

Cubeta GN con fondo difusor
Bac GN avec fond thermo-diffuseur



PATENTED EXCLUSIVE



REF	Tipo / Type	H mm	Lts	
P1106F1	1/1	65	8,3	1
P1110F1	1/1	100	14,2	1
P1115F1	1/1	150	20,2	1
P1206F1	1/2	65	4,1	1

Sandwich bottom GN container with handles

Cubeta GN con fondo difusor y asas
Bac GN avec fond thermo-diffuseur et anses



PATENTED EXCLUSIVE



REF	Tipo / Type	H mm	Lts	
P1110F2	1/1	100	14,2	1
P1115F2	1/1	150	20,2	1

See products on
Ver productos en / Voir produits en page

P. 401

Non-stick GN container
Cubeta GN antiadherente
Bac GN anti-adhésive



7.4 Super Pan 3

NEW!

SS
Stainless
steel

Reinforced spouted-shape corners
Esquinas reforzadas con forma de pico
Coins renforcés en forme de bec

Anti-jam stacking lugs
Apilado antiatascos
Pointes d'empilage anti-coincement

Narrow radius
Radio estrecho
Rayon étroit

Bordes aplanados
Flattened pan edges
Bords de bacs gn aplatis



1/1 530 x 325 mm



REF	H mm	Lts	
90002	20	-	6
90012	40	5,4	6
90052	55	7,3	6
90022	65	8,5	6
90042	100	13,4	6
90062	150	19,9	6
90082	200	26,1	3

2/3 353 x 325 mm



REF	H mm	Lts	
90102	20	-	6
90112	40	3,4	6
90122	65	5,4	6
90142	100	8,0	6
90162	150	11,9	3
90182	200	15,5	3

1/2 325 x 265 mm



REF	H mm	Lts	
90202	20	-	6
90212	40	2,4	6
90252	55	3,3	6
90222	65	3,8	6
90242	100	6,0	6
90262	150	8,9	6
90282	200	11,6	3

2/4 530 x 162 mm



REF	H mm	Lts	
90502	20	-	6
90512	30	2,4	6
90552	55	3,1	6
90522	65	3,7	6
90542	100	5,7	3
90562	150	8,2	3

Super Pan 3 7.4

NEW!

SS
Stainless
steel

1/3 325 x 176 mm



REF	H mm	Lts	
90302	20	-	6
90312	40	1,6	6
90352	55	2,0	6
90322	65	2,4	6
90342	100	3,7	6
90362	150	5,5	6
90382	200	7,1	3

1/6 176 x 162 mm



REF	H mm	Lts	
90622	65	1,1	6
90642	100	1,6	6
90662	150	2,3	6
90682	200	3,0	3

1/4 265 x 162 mm



REF	H mm	Lts	
90402	20	-	6
90412	40	1,1	6
90452	55	1,5	6
90422	65	1,7	6
90442	100	2,6	6
90462	150	3,8	6
90482	200	4,8	3

1/9 176 x 108 mm



REF	H mm	Lts	
90922	65	0,60	6
90942	100	0,80	6

1/1 530 x 325 mm



REF	H mm	
90013	40*	6
90053	55*	6
90023	65*	6
90043	100**	6
90063	150**	6

1/2 325 x 265 mm



REF	H mm	
90213	40*	6
90223	65*	6
90243	100**	6
90263	150**	6

93100 Lid Tapa Couvercle



Lids and false bottoms, use the same as our standard range.
False bottoms just to 100 mm depth.

Tapas y fondos perforados, se pueden utilizar los de la gama de cubetas inox.
Fondos hasta 100 mm de profundidad.

Couvercles and egouttoirs, utiliser les memes que la gamme standard.
Egouttoirs jusqu'à 100 mm profondeur.

REF	Mod	
93100	1/1	6
93110	2/3	6
93200	1/2	6
93500	2/4	6
93300	1/3	6
93400	1/4	6
93600	1/6	6
93900	1/9	6

*Perforated bottom.
*Fondo perforado.
*Fond perforé.

**Perforated bottom and sides.
**Fondo y laterales perforados.
**Fonds et latéraux perforés.

7.5 Polycarbonate gastronorm

Gastronorm policarbonato
Gastronorme polycarbonate



-40 °C
+130 °C

Use: storage of bulk products, various ingredients in refrigerators or cold rooms. For cold buffet presentation.

Utilización: almacenamiento de productos a granel, ingredientes varios en neveras o cámaras frigoríficas. Ideales para presentación en buffets fríos.

Utilisation : stockage de produits en vrac, divers ingrédients dans des réfrigérateurs ou des chambres froides. Pour présentation de buffets froids.



1/1 530 x 325 mm



REF	H mm	Lts	
P1106C1	65	8,70	12
P1110C1	100	13,30	12
P1115C1	150	19,60	12
P1120C1	200	25,50	6

1/2 325 x 265 mm



REF	H mm	Lts	
P1206C1	65	4,00	24
P1210C1	100	6,00	24
P1215C1	150	8,70	24
P1220C1	200	11,20	18

1/3 325 x 175 mm



REF	H mm	Lts	
P1306C1	65	2,35	18
P1310C1	100	3,50	12
P1315C1	150	5,00	12
P1320C1	200	6,35	6

1/4 265 x 162 mm



REF	H mm	Lts	
P1406C1	65	1,65	18
P1410C1	100	2,46	18
P1415C1	150	3,47	12

Polycarbonate gastronorm 7.5

Gastronorm policarbonato
Gastronorme polycarbonate



1/6 176 x 162 mm



REF	H mm	Lts	
P1606C1	65	0,95	30
P1610C1	100	1,40	24
P1615C1	150	1,95	24

Polycarbonate lid

Tapa policarbonato
Couvercle Polycarbonate



REF	Mod	
P1100C1	1/1	30
P1200C1	1/2	60
P1300C1	1/3	30
P1400C1	1/4	30
P1600C1	1/6	60
P1900C1	1/9	60

Polinorm® Lid

Tapa Polinorm®
Couvercle Polinorm®



REF	Mod	
P1100 + COLOR	1/1	30
P1200 + COLOR	1/2	60
P1300 + COLOR	1/3	30
P1400 + COLOR	1/4	30
P1600 + COLOR	1/6	60
P1900 + COLOR	1/9	60

1/9 176 x 108 mm



REF	H mm	Lts	
P1906C1	65	0,54	54
P1910C1	100	0,77	30

Perforated bottom

Fondo perforado
Fond perforé



REF	Mod	
P1150C1	1/1	36
P1250C1	1/2	24
P1350C1	1/3	24
P1450C1	1/4	30

Ref. colour lid

Ref. color tapa
Ref. couleur couvercle

- P1 P2 P3 P4 P5
- P6 Available for 1/1, 1/2, 1/3 and 1/6
Disponible para 1/1, 1/2, 1/3 y 1/6
Disponible pour 1/1, 1/2, 1/3 et 1/6

St/Steel, PC, Bisphenol-A FREE and PP GN containers.
Not for SP3 range.

Cubetas GN inox, PC, sin Bisfenol-A y PP.
No aptas para la gama SP3.

Bacs GN inox, PC, sans Bisphénol-A et PP.
Pas pour la gamme SP3.

7.6 Gastronorm containers, Bisphenol-A free

Cubetas gastronorm sin Bisfenol-A
Bacs gastronorme sans Bisphénol-A



-40 °C
+90 °C



Containers made of copolyester without Bisphenol-a (100% BPA FREE). An alternative material to polycarbonate. Complies with european standard en 631.1 (compatible with gastronorm systems and appliances) excellent transparency and impact resistance. Ideal for storing products in cold rooms, for preparation. Stackable containers.

Cubetas en copoliester sin Bisfenol-a (100% BPA FREE). Es un material alternativo al policarbonato. Conformes con la norma europea en 631.1 (compatible con los equipos y aparatos gastronorm). Excelente transparencia y resistencia a los impactos. Ideales para almacenar productos en cámaras frigoríficas, de preparación. Cubetas apilables.

Bacs en copolyester sans Bisphénol-a (100% BPA FREE). Il s'agit d'un matériau alternatif au polycarbonate. Conformes à la norme européenne en 631.1 (compatible avec les machines et appareils gastronorm). Excellentes transparence et résistance aux chocs. Idéales pour emmagasiner des produits dans des chambres froides, de préparation. Cuvettes empilables.

1/1 530 x 325 mm



REF	H mm	Lts	
P1106BF	65	8,70	12
P1110BF	100	13,30	12
P1115BF	150	19,60	12
P1120BF	200	25,50	6

1/2 325 x 265 mm



REF	H mm	Lts	
P1206BF	65	4,00	24
P1210BF	100	6,00	24
P1215BF	150	8,70	24
P1220BF	200	11,20	18

1/3 325 x 175 mm



REF	H mm	Lts	
P1306BF	65	2,35	18
P1310BF	100	3,50	12
P1315BF	150	5,00	12

1/4 265 x 162 mm



REF	H mm	Lts	
P1406BF	65	1,65	18
P1410BF	100	2,46	18
P1415BF	150	3,47	12

Gastronorm containers, Bisphenol-A free 7.6

Cubetas gastronorm sin Bisfenol-A
Bacs gastronorme sans Bisphénol-A



1/6 176 x 162 mm



REF	H mm	Lts	
P1606BF	65	0,95	30
P1610BF	100	1,40	24
P1615BF	150	1,95	24

1/9 176 x 108 mm



REF	H mm	Lts	
P1906BF	65	0,54	54
P1910BF	100	0,77	30

Gastronorm lid
Tapa gastronorm
Couvercle gastronorme



REF	Mod	
P1100BF	1/1	30
P1200BF	1/2	60
P1300BF	1/3	30
P1400BF	1/4	30
P1600BF	1/6	60
P1900BF	1/9	60

Perforated bottom
Fondo perforado
Fond perforé



REF	Mod	
P1150BF	1/1	36
P1250BF	1/2	24
P1350BF	1/3	24
P1450BF	1/4	30
P1650BF	1/6	30

Polinorm® Lid
Tapa Polinorm®
Couvercle Polinorm®

PATENTED EXCLUSIVE



Ref. colour lid
Ref. color tapa
Ref. couleur couvercle

P1 P2 P3 P4 P5
P6 Available for 1/1, 1/2, 1/3 and 1/6
Disponible para 1/1, 1/2, 1/3 y 1/6
Disponible pour 1/1, 1/2, 1/3 et 1/6

REF	Mod	
P1100 + COLOR	1/1	30
P1200 + COLOR	1/2	60
P1300 + COLOR	1/3	30
P1400 + COLOR	1/4	30
P1600 + COLOR	1/6	60
P1900 + COLOR	1/9	60

St/Steel, PC, Bisphenol-A FREE and PP GN containers.
Not for SP3 range.

Cubetas GN inox, PC, sin Bisfenol-A y PP.
No aptas para la gama SP3.

Bacs GN inox, PC, sans Bisphénol-A et PP.
Pas pour la gamme SP3.

7.7 Polypropylene gastronorm

Gastronorm polipropileno
Gastronorme polypropylène



PATENTED EXCLUSIVE



-40 °C
+110 °C

Use to store bulk products and ingredients in coolers, freezers or pantry. Highly recommended for transportation and micro-waves cooking. Translucent plastic makes inventory easy. High resistance to chemicals.

Utilización: almacenamiento de productos a granel, ingredientes varios en neveras o cámaras frigoríficas. Ideal para transporte y cocción en microondas. El plástico translúcido facilita el inventario. Alta resistencia a productos químicos.

Utilisation: stockage de produits et ingrédients en vrac dans des unités réfrigérées ou placards. Idéal pour le transport et la cuisson en FOUR micro-ondes. Le plastique translucide facilite l'inventaire. Haute résistance aux produits chimiques.

1/1 530 x 325 mm



REF	H mm	Lts	
P1106P1	65	8,70	12
P1110P1	100	13,30	12
P1115P1	150	19,60	12
P1120P1	200	25,50	6

1/2 325 x 265 mm



REF	H mm	Lts	
P1206P1	65	4,00	24
P1210P1	100	6,00	24
P1215P1	150	8,70	24
P1220P1	200	11,20	18

Polypropylene gastronorm 7.7

Gastronorm polipropileno
Gastronorme polypropylène



1/3 325 x 175 mm



REF	H mm	Lts	
P1306P1	65	2,35	18
P1310P1	100	3,50	12
P1315P1	150	5,00	12
P1320P1	200	6,35	6

1/4 265 x 162 mm



REF	H mm	Lts	
P1406P1	65	1,65	18
P1410P1	100	2,46	18
P1415P1	150	3,47	12

1/6 176 x 162 mm



REF	H mm	Lts	
P1606P1	65	0,95	30
P1610P1	100	1,40	24
P1615P1	150	1,95	24

1/9 176 x 108 mm



REF	H mm	Lts	
P1906P1	65	0,54	54
P1910P1	100	0,77	30

Polycarbonate lid
Tapa policarbonato
Couvercle Polycarbonate



REF	Mod	
P1100C1	1/1	30
P1200C1	1/2	60
P1300C1	1/3	30
P1400C1	1/4	30
P1600C1	1/6	60
P1900C1	1/9	60

Polinorm® Lid
Tapa Polinorm®
Couvercle Polinorm®

PATENTED EXCLUSIVE



REF	Mod	
P1100 + COLOR	1/1	30
P1200 + COLOR	1/2	60
P1300 + COLOR	1/3	30
P1400 + COLOR	1/4	30
P1600 + COLOR	1/6	60
P1900 + COLOR	1/9	60

Ref. colour lid
Ref. color tapa
Ref. couleur couvercle



P6 Available for 1/1, 1/2, 1/3 and 1/6
Disponible para 1/1, 1/2, 1/3 y 1/6
Disponible pour 1/1, 1/2, 1/3 et 1/6

7.8 Violet Collection



VIOLET COLLECTION

-40 °C
+110 °C

Use to store bulk products and ingredients in coolers, freezers or pantry. Highly recommended for transportation and micro-waves cooking.

Utilización: almacenamiento de productos a granel, ingredientes varios en neveras o cámaras frigoríficas. Ideal para transporte y cocción en microondas.

Utilisation: stockage de produits et ingrédients en vrac dans des unités réfrigérées ou placards. Idéal pour le transport et la cuisson en four micro-ondes.

Gastronorm containers
Cubetas Gastronorm
Bacs Gastronorme



Polinorm® Lid
Tapa Polinorm®
Couvercle Polinorm®



P6 Ref. colour lid
Ref. color tapa
Ref. couleur couvercle

Adjustable to St/Steel, PC, Bisphenol-A FREE and PP GN containers. Not for SP3 range.
Adaptable a cubetas GN inox, PC, sin Bisfenol-A y PP. No aptas para la gama SP3.
Adaptable à bacs GN inox, PC, sans Bisphénol-A et PP. Pas pour la gamme SP3.

REF	Type / Tipo	H mm	Lts	☐
P1115P6	1/1	150	19,60	12
P1215P6	1/2	150	8,70	24
P1315P6	1/3	150	5,00	12
P1615P6	1/6	150	1,95	24

REF	Mod	☐
P1100P6	1/1	30
P1200P6	1/2	60
P1300P6	1/3	30
P1600P6	1/6	60



8 Food delivery

Transporte de alimentos
Transport d'aliments



8.1 EPPBOX 212

CAJA PPE

BOÎTE PPE

8.2 INSULATED DELIVERY BAGS 214

BOLSAS DE REPARTO

SACS DE LIVRAISON ISOTHERMES

Pizza Bags / Bolsas para pizza / Sacs à pizzas 214

Catering Bags / Bolsas de catering / Sacs de traiteur / 216

Delivery Backpacks / Mochila de reparto / Sacs à dos de livraison 218

8.3 TRAYS AND CONTAINERS 220

BANDEJAS Y RECIPIENTES

PLATEAUX ET RÉCIPIENTS

EPPbox 8.1

Caja PPE

Boîte PPE

Manufactured in expanded polypropylene (EPP) allowing cold and heat to be maintained for hours

Fabricado en polipropileno expandido (PPE) permite la conservación del frío y el calor durante horas

Fabriqué en polypropylène expansé (PPE) qui permet la conservation du froid et de la chaleur pendant plusieurs heures

Inner slot for easy insertion of containers

Ranura interior para fácil inserción de cubetas
Rainure intérieure pour une installation facile des bacs

Superior load, GN 1/1

Carga superior, 1/1 GN
Charge supérieure, 1/1 GN

Inset handles on the sides

Asas encastradas en los laterales
Anses encastrées sur les côtés

100% recyclable

100% reciclable
100 % recyclable

Foldable to make storage and transport easier

Plegable para facilitar el almacenaje y el transporte
Pliable pour faciliter le stockage et le transport

P99001 Foldable EPP box

Caja plegable PPE

Boîte pliable EPP



REF	W x D x H cm	Inner sizes Dim int / Dim. int. cm	Lt	GN	
P99001	60 x 40 x 25	53,8 x 33,8 x 20	38	1/1	1

8.2 Pizza Bags

Bolsas para pizza
Sacs à pizzas

Transparent pocket
Bolsillo transparente
Poche transparente

Reinforced handles for ease of transport
Asas reforzadas para fácil transporte
Anses renforcées pour un transport facile

Thermal insulation to maintain the temperature
Aislamiento térmico para conservar la temperatura
Isolation thermique pour conserver la température

Band to be able hang the bag
Cinta para poder colgar la bolsa
Bande pour pouvoir accrocher le sac

Thick, sturdy and easy to clean material
Material grueso y resistente fácil de limpiar
Matériau épais et résistant, facile à nettoyer



P9902 Pizza Bags
Bolsas para pizza
Sacs à pizzas



REF	W x D x H cm	
P99020	45 x 45 x 16	1
P99021	49,5 x 49,5 x 26	1

Pizza Bags 8.2

Bolsas para pizza
Sacs à pizzas

Transparent pocket with zipper
Bolsillo transparente con cremallera
Poche transparente avec fermeture Éclair

Thermal insulation to maintain the temperature
Aislamiento térmico para conservar la temperatura
Isolation thermique pour conserver la température

Reinforced handles for ease of transport
Asas reforzadas para fácil transporte
Anses renforcées pour un transport facile

Band to be able hang the bag
Cinta para poder colgar la bolsa
Bande pour pouvoir accrocher le sac

Reflective piping for safer night time delivery
Ribetes reflectantes para un reparto nocturno más seguro
Passepoil réfléchissant pour des livraisons plus sûres la nuit

Moisture-resistant outer shell
Carcasa exterior resistente a la humedad
Enveloppe extérieure résistant à l'humidité



VPB Pizza Bags
Bolsas para pizza
Sacs à pizzas



VPB118
18" Pizza bag
Bolsa para pizza, 18"
Sac à pizzas, 18"



VPB116
16" Pizza bag
Bolsa para pizza, 16"
Sac à pizzas, 16"



REF	Serie	W x D x H cm	
VPB116	SERIE 1	44,5 x 44,5 x 22,9	5
VPB118	SERIE 1	48,3 x 48,3 x 22,9	5

8.2 Catering Bags

Bolsas de catering
Sacs de traiteur

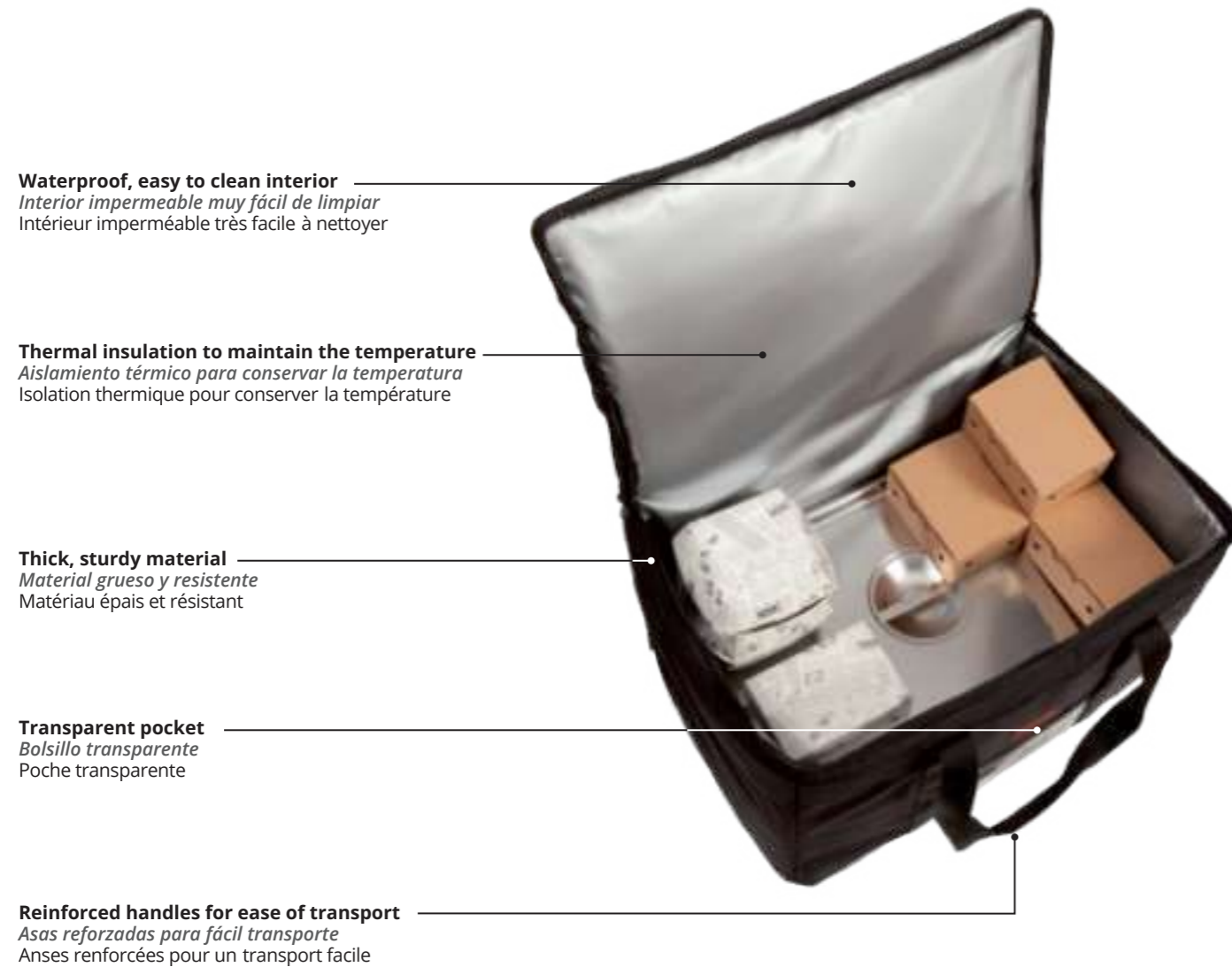

P9903 Catering bags

Bolsas de catering
Sacs de traiteur



P99031



P99030

REF	W x D x H cm	GN	
P99030	38 x 30,5 x 38	1/2	1
P99031	56 x 36 x 36	1/1	1

Catering Bags 8.2

Bolsas de catering
Sacs de traiteur

Polyester lining easy to clean
Interior de poliéster fácil de limpiar
Intérieur en polyester facile à nettoyer

Reflective piping for safer night time delivery
Ribetes reflectantes para un reparto nocturno más seguro
Passepoil réfléchissant pour des livraisons plus sûres la nuit

Moisture-resistant outer shell
Carcasa exterior resistente a la humedad
Enveloppe extérieure résistant à l'humidité

Thermal insulation to maintain the temperature
Aislamiento térmico para conservar la temperatura
Isolation thermique pour conserver la température

Transparent pocket
Bolsillo transparente
Poche transparente

Reinforced handles for ease of transport
Asas reforzadas para fácil transporte
Anses renforcées pour un transport facile

VCB Catering bags

Bolsas de catering
Sacs de traiteur



VCBL100



VCBM100

REF	Serie	W x D x H cm	
VCBM100	SERIE 1	43,2 x 33 x 33	5
VCBL100	SERIE 1	58,4 x 38,1 x 35,6	5



FOOD DELIVERY
TRANSPORTE ALIMENTOS
TRANSPORT ALIMENTS

Delivery Backpacks 8.2

Mochila de reparto
Sacs à dos de livraison

VTB Tower bags Bolsas torre Sacs-Tours

Tower bag with backpack straps and headrest strap
Bolsa tipo torre con asas de mochila y correa de reposacabezas
Sac-tour avec bretelles de sac à dos et sangle d'appui-tête



REF	Serie	W x D x H cm	📦
VTB300	SERIE 3	45,7 x 55,9 x 43,2	3
VTB50002	SERIE 5	45,7 x 55,9 x 43,2	1

VDBBM Food delivery backpack bags Mochila reparto de alimentos Sacs à dos de livraison d'aliments

Food delivery backpack bag with integrated frame
Bolsa mochila con bastidor integrado para reparto de alimentos
Sac à dos de livraison d'aliments à armature intégrée



REF	Serie	W x D x H cm	📦
VDBBM300	SERIE 3	40,6 x 40,6 x 33	3
VDBBM50002	SERIE 5	40,6 x 40,6 x 33	1

ACCESSORIES / ACCESORIOS / ACCESSOIRES

VTBWR-1 Wire insert Estructura metálica Structure métallique



REF	📦
VTBWR-1	1

Accessory not included
Accesorio no incluido
Accessoire non inclus



Bags & wire inserts fold easily for compact storage

Las bolsas y los insertos de alambre se pliegan fácilmente para un almacenamiento compacto

Les sacs et les inserts métalliques se plient facilement pour un rangement compact



Serie 3

The baseline of warmth ingenuity. The hot food generates heat in the bag while the high performance insulation helps retain the heat, keeping food as warm as it is delicious.
INCLUDES: Bag

La pauta de referencia del ingenio térmico.
La comida caliente genera calor en la bolsa mientras que el aislamiento de alto rendimiento ayuda a retenerlo, manteniendo la comida caliente y deliciosa.
INCLUYE: Bolsa

La référence en matière d'ingénierie. Les aliments chauds dégagent de la chaleur dans le sac tandis que l'isolant ultra-performant la conservent, tout en gardant les aliments aussi chauds que délicieux.
INCLUS: Housse de transport



Serie 5

The next step in our heating bag line features a heat pad that pre-heats the bag. Place your hot food into the pre-heated bag, unplug the heat pad and go. Or use the optional 12V in-car power cord to continually heat the bag during transport.
INCLUDES: Bag / Heat Pad / adaptor heat pad with plug
OPTIONAL: 12V In-car power cord

El siguiente nivel en nuestra línea de bolsas de reparto incluye una almohadilla térmica que precalienta la bolsa. Coloque la comida caliente en la bolsa precalentada, desenchufe la almohadilla térmica y listo. O use el cable de alimentación opcional de 12V en el automóvil para calentar continuamente la bolsa durante el transporte.
INCLUYE: Bolsa / Heat pad / Adaptador heat pad con enchufe
OPCIONAL: Cable conector coche 12V

Le niveau supérieur dans notre ligne de sacs de livraison incorpore un coussin chauffant qui préchauffe le sac. Placez vos aliments chauds dans le sac préchauffé, débranchez le coussin chauffant et partez faire votre livraison. Ou utilisez le câble d'alimentation 12V en option sur la prise du véhicule pour continuer à chauffer le sac pendant le transport.
INCLUS: Housse de transport / Corps de chauffe / Adaptateur prise corps de chauffe.
OPTION: Cordon d'alimentation 12V de voiture



FOOD DELIVERY
TRANSPORTE ALIMENTOS
TRANSPORT ALIMENTS

8.3 Trays and containers

Bandejas y recipientes
Plateaux et récipients

P919001 Polycarbonate tray with 5 compartments
Bandeja policarbonato de 5 compartimentos
Plateau polycarbonate avec 5 compartiments



Stackable
Apilable
Empilable

*** For use with Polycarbonate tray only**
Sólo usar con bandeja de Polycarbonato
Utiliser uniquement plateau en Polycarbonate

Dishwasher safe
Apto para lavavajillas
Utilisable au lave-vaisselle

REF	W x D x H cm	
P919001	33 x 33 x 3,5	1
P919002*	cover / tapa / couvercle	1

P919003 Polypropylene tray with 5 compartments
Bandeja polipropileno de 5 compartimentos
Plateau polypropylène avec 5 compartiments



Stackable
Apilable
Empilable

Dishwasher safe
Apto para lavavajillas
Utilisable au lave-vaisselle

REF	W x D x H cm	
P919003	33 x 33 x 3,5	1

P919 Isothermal tray
Bandeja isotérmica
Plateau Isotherme



Made of polypropylene with insulating polyurethane without CFC interior.

Fabricada en polipropileno con interior aislante de poliuretano. Sin CFC.
Fabriqué en polypropylène avec intérieur isolant de polyuréthane sans CFC.

Suitable for flat plate, soup plate, bowl, salad bowl on polycarbonate, chinaware or melamine.
Adaptado para plato llano, hondo, bol, fuente rectangular en policarbonato, porcelana o melamina.

Apte pour assiettes plates, à soupe, bols, ravier, soit en polycarbonate, porcelaine ou melamine.

Complements not included / Complementos no incluidos
Compléments non-inclus

REF	W x D x H cm	
P919000	53 x 37 x 11	3

See products on
Ver productos en / Voir produits en page **P. 256**

Tray transport trolley
Carro transporte bandejas
Chariot transport plateaux



Trays and containers 8.3

Bandejas y recipientes
Plateaux et récipients

P920 Polycarbonate plates
Platos policarbonato
Assiettes en polycarbonate



P920001

Dishwasher and microwave safe
Apto para lavavajillas y microondas
Utilisable au lave-vaisselle et micro-ondes

REF	Type / Tipo	Ø cm	H cm	
P920001	Flat / Llano / Plat	20,6	2,9	126
P920002	Soup / Hondo / À soupe	18,5	4,5	50
P920003	Breakfast / Desayuno / Petit déjeuner	17,5	2,5	40

P921 Double wall polycarbonate bowl with lid
Bol doble pared policarbonato con tapa
Bol polycarbonate double paroi avec couvercle



Dishwasher safe
Apto para lavavajillas
Utilisable au lave-vaisselle

REF	Ø cm	H cm	Lts	
P921001	12,5	6,8	0,45	1

P922 Polycarbonate rectangular bowl
Fuente rectangular policarbonato
Ravier rectangulaire en polycarbonate



Dishwasher and microwave safe
Apto para lavavajillas y microondas
Utilisable au lave-vaisselle et micro-ondes

***Rigid lid**
*Tapa rígida
*Couvercle rigide

REF	W x D x H cm	Lts	
P922000	9,5 x 13,8 x 4,5	0,25	144
P922100*	9,6 x 13,9 x 2,4	-	288

P923 Polycarbonate breakfast cup
Taza desayuno policarbonato
Tasse petit déjeuner polycarbonate



P923000 P923001



Dishwasher and microwave safe
Apto para lavavajillas y microondas
Utilisable au lave-vaisselle et micro-ondes

***Lid**
*Tapa
*Couvercle

REF	Ø cm	H cm	Lts	
P923000	9,4	6,8	0,325	50
P923001*	10,0	-	-	100

P924 Polycarbonate glass
Vaso policarbonato
Verre en polycarbonate



REF	Couleur / Color	Ø cm	H cm	Lts	
P924001		7	10,2	0,25	50
P924002		7	7,0	0,17	50
P924002A		7	7,0	0,17	50
P924002R		7	7,0	0,17	50
P924002V		7	7,0	0,17	50

-30 °C Dishwasher safe
Apto para lavavajillas
Utilisable au lave-vaisselle

8.3 Trays and containers

Bandejas y recipientes
Plateaux et récipients

P8610 Fiberglass fast - food tray
Bandeja fast - food fibra de vidrio
Plateau fast - food fibre de verre



Grey color
Color gris
Couleur gris

REF	cm	
P861045	45,5 x 35,5	12
P861053	53,0 x 32,5	12

P340 St/steel self - service tray
Bandeja auto - servicio acero inox
Plateau self - service acier inox



6 Compartments
6 Compartimentos
6 Compartiments

REF	W x D x H cm	
P340000	46 x 28,5 x 2	1

See products on **P. 240**
Ver productos en / Voir produits en page

GN, isothermal trays and plates rack
Cesta para bandejas isotérmicas, GN y platos
Panier pour plateaux isothermes, GN et assiettes



86100 Polypropylene fast - food trays
Bandejas fast - food de polipropileno
Plateaux fast - food en polypropylène



Recyclable
Recyclable
Recyclable



REF	cm	
86100	25,4 x 35,6	24
86101	25,4 x 35,6	24
86103	25,4 x 35,6	24
86104	25,4 x 35,6	24
86105	25,4 x 35,6	24
86106	25,4 x 35,6	24
86107	25,4 x 35,6	24
86108	25,4 x 35,6	24
86109	25,4 x 35,6	24
86110	30,5 x 40,6	24
86111	30,5 x 40,6	24
86113	30,5 x 40,6	24
86114	30,5 x 40,6	24
86115	30,5 x 40,6	24
86116	30,5 x 40,6	24
86117	30,5 x 40,6	24
86118	30,5 x 40,6	24
86119	30,5 x 40,6	24
86120	35,6 x 45,7	12
86121	35,6 x 45,7	12
86123	35,6 x 45,7	12
86124	35,6 x 45,7	12
86125	35,6 x 45,7	12
86126	35,6 x 45,7	12
86127	35,6 x 45,7	12
86128	35,6 x 45,7	12
86129	35,6 x 45,7	12

Thick reinforced rim with corner ribs add impact strength. Four stacking lugs speed drying and prevent sticking. Semi-gloss, weave-grain textured finish provides a reduced-slip surface.

El borde grueso reforzado con acanalados en las esquinas añade resistencia a los impactos. Cuatro cuñas de apilado para secar rápidamente y evitar que se peguen entre sí. Acabado texturizado entretrejado semibrillante que aporta una superficie menos resbaladiza.

Rebord reforcé épais avec nervures aux angles pour accroître la résistance aux chocs. Les quatre cales d'empilage accélèrent le séchage et empêchent les plateaux de coller entre eux. La texture tissée semi-brillante apporte une surface moins glissante.

Trays and containers 8.3

Bandejas y recipientes
Plateaux et récipients

P8070 Counter - top cutlery dispenser
Soporte para bandejas porta - cubiertos
Support porte - couverts



Compatible: P900000

Cutterly bin not included
No incluye bandeja porta-cubiertos
Bac ramasse - couverts non inclus

REF	W x D x H cm	
P80700	52,6 x 51 x 32,8	1

P8071 Double counter - top cutlery dispenser
Soporte doble para bandejas porta - cubiertos
Support double porte - couverts



Compatible: P900000

Cutterly bin not included
No incluye bandeja portacubiertos
Bac ramasse - couverts non inclus

REF	W x D x H cm	
P80710	52,6 x 51 x 58	1

P8072 Counter - top dispenser for 4 GN containers 1/3
Soporte para 4 cubetas GN 1/3
Support pour 4 bacs GN 1/3



Cutterly bin not included
No incluye bandeja portacubiertos
Bac ramasse - couverts non inclus

REF	W x D x H cm	
P80720	73,8 x 31 x 43	1

P8073 Counter - top dispenser for 8 GN containers 1/3
Soporte para 8 cubetas GN 1/3
Support pour 8 bacs GN 1/3



Cutterly bin not included
No incluye bandeja portacubiertos
Bac ramasse - couverts non inclus

REF	W x D x H cm	
P80730	73,8 x 46,5 x 60	1

P900 1/1 gastronorm cutlery bin
Bandeja porta - cubiertos gastronorm 1/1
Bac ramasse - couverts gastronorme 1/1



REF	W x D x H cm	
P900000	53 x 32,5 x 10	10

Food contact polypropylene
Polipropileno alimentario
Polypropylène alimentaire



9 Dishwasher racks

Cestas para vajilla
Casiers à vaisselle

9.1 OPENRACKS 230

CESTAS ABIERTAS
CASIERIS OUVERTS

9.2 OPENASSEMBLED RACKS 232

CESTAS MONTADAS ABIERTAS
CASIERIS MONTÉS OUVERTS

9.3 CLOSEDASSEMBLED RACKS 234

CESTAS MONTADAS CERRADAS
CASIERIS MONTÉS FERMÉS

9.4 COMPLEMENTS 236

COMPLEMENTOS
COMPLÉMENTS

9.5 PLATERACKS 238

CESTAS PARA PLATOS
CASIERIS ASSIETTES

Easy assembly and disassembly system.
Sistema de montaje y desmontaje fácil.
Système de montage et démontage facile.

OPEN - WASHING
ABIERTA - LAVADO
OUVERT - LAVAGE

Faster wash and rinse.
Limpeza y secado rápido.
Lavage et séchage plus rapide.

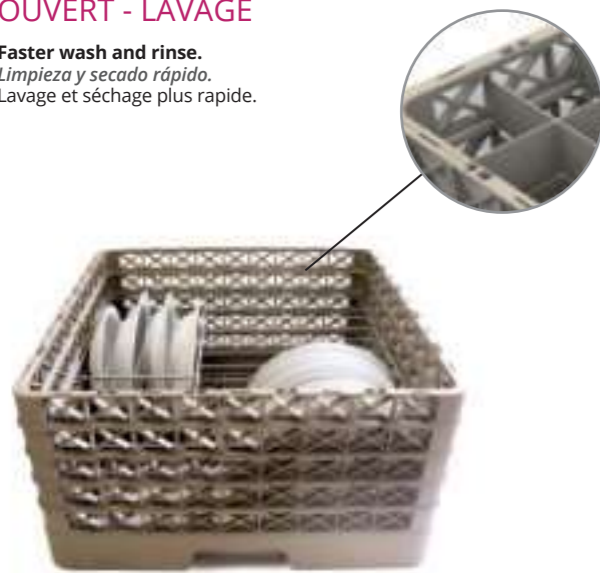

Stackable with other brands of racks, reinforced double-wall (anti-shock).

Apilables con otras cestas del mercado, refuerzo de doble pared (anti-golpes).

Empilables avec d'autres casiers du marché, renfort avec double paroi (anti-choc).

CLOSED - TRANSPORT
CERRADA - TRANSPORTE
FERMÉ - TRANSPORT

More safety and hygienic storing and transporting.
Almacenamiento y transporte más seguro e higiénico.
Stockage et transport plus sûr et hygiénique.

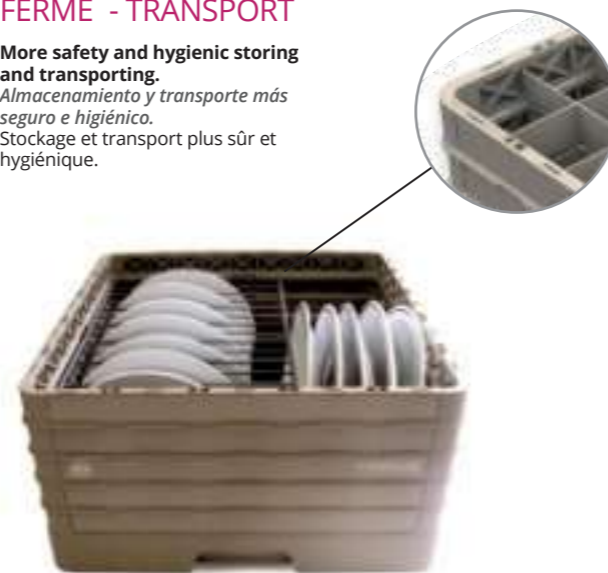

GET THE BEST OF BOTH WORLDS*
*ESCOGER LO BUENO Y LO MEJOR A LA VEZ**
*LE BON ET LE MEILLEUR À LA FOIS**

FLAP-RACK®: easy to assemble / disassemble
FLAP-RACK®: fácil montaje / desmontaje
FLAP-RACK®: facile à monter / démonter

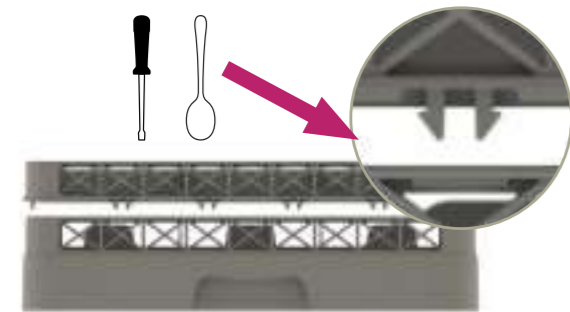

* Copolymer highly resistant to chemical products and temperatures up to 95 °C.
* Copolímero altamente resistente a sustancias químicas y temperaturas de hasta 95 °C.
* Copolymère très résistant aux produits chimiques et à températures jusqu'à 95 °C.

SQUARE COMPARTMENTS
COMPARTIMENTOS CUADRADOS
COMPARTIMENTS CARRÉS



System patented allows the walls on both bases and extenders to be closed or open easily

Sistema patentado que permite cerrar y abrir las paredes de las cestas y extensiones fácilmente

Système breveté qui permet d'ouvrir ou de fermer facilement les parois des casiers et des réhausseuses

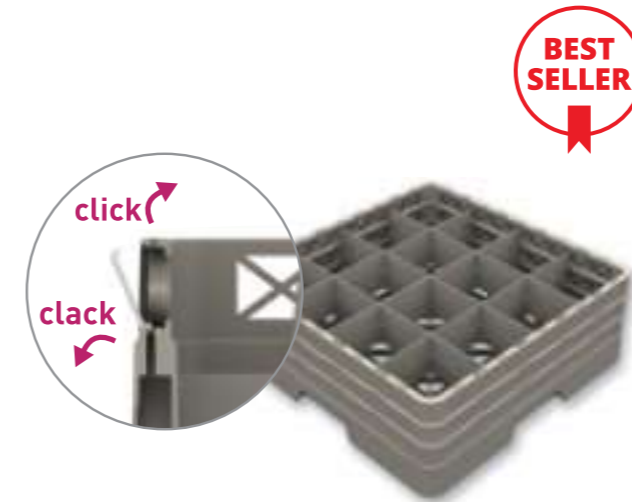

WASHING: Higher cleaning
LAVADO: Mayor limpieza
LAVAGE: Meilleur nettoyage



TRANSPORT: Higher security
TRANSPORTE: Mayor seguridad
TRANSPORT: Plus de sécurité



STORING: Higher hygiene
ALMACENAMIENTO: Mayor Higiene
STOCKAGE: Plus hygiénique

FLAP IDENTIFICADOR

Colour identification for completely closed racks and extensions.
Available in 6 colours. Possible customization.

Identificador de colores para cestas y extensiones completamente cerradas. Disponible en 6 colores. Posibilidad de marcar logo cliente.

Identificateur en couleurs pour casiers et réhausseuses complètement fermés. Disponible en 6 couleurs. Personnalisation possible.

501F Flap

FLAP RACK®



REF	Colour / Color / Couleur	📦
P501 F1	Brown / Marrón / Marron	24
P501 F2	Burgundy / Burdeos / Bordeaux	24
P501 F3	Blue / Azul / Bleu	24
P501 F4	Yellow / Amarillo / Jaune	24
P501 F5	Green / Verde / Vert	24
P501 F6	Dark brown / Marrón oscuro / Marron foncé	24



Printed logo or text / Logo o texto impreso / Logo ou texte imprimé



Hot stamped logo or text / Logo o texto estampado / Logo ou texte gravé

T-VERSION

DESIGNED TO HOLD 17-30% MORE GLASSWARE THAN A TRADITIONAL RACK

DISEÑADAS CON UN 17-30% MÁS DE CAPACIDAD PARA VASOS Y COPAS QUE LAS CESTAS TRADICIONALES

CONÇUS POUR CONTENIR DE 17 À 30 % DE VERRES EN PLUS QU'UN CASIER TRADITIONNEL

SNAP-FIT EXTENDERS

Will not loosen or come apart over time
Assembled racks can not be refunded

EXTENSORES A PRESIÓN

No se sueltan con el tiempo
No se aceptan devoluciones de cestas montadas

RÉHAUSSES CLIPSABLES

Sans détachements au fil du temps
Tout retour de casiers montés n'est pas accepté

SMALL SIDE COMPARTMENTS

hold flatware, salt shakers, ramekins, ...

LOS COMPARTIMENTOS LATERALES PEQUEÑOS aceptan cubiertos, saleros, potes, ...

PETITS COMPARTIMENTS LATÉRAUX

pour couverts, salières, ramequins, ...

OPEN PROFILE DESIGN

Allows top-to-bottom and side-to-side washing and drying

DISEÑO DE PERFIL ABIERTO

Permite un lavado y secado de arriba a abajo y de lado a lado

CONCEPT À PROFIL OUVERT

Permet un lavage et un séchage de haut en bas et d'un côté à l'autre

CONVENIENT HANDLING With handles in all four sides

MANEJO CÓMODO Con asas en los cuatro lados
MANIPULATION PRATIQUE Grâce aux poignées des quatre côtés

BUILT-IN BASE RACK DIVIDERS provide 100% vertical glassware protection

LOS DIVISORES INCORPORADOS brindan una protección 100% vertical de los vasos y las copas
LES PARTITIONS DE CASIER DE BASE INTÉGRÉES offrent une protection des verres 100% verticale

COLOUR IDENTIFICATION CLIP for easy identification

CLIPS DE IDENTIFICACIÓN DE COLORES para facilitar la identificación
CLIPS IDENTIFICATEURS EN COULEURS pour une identification plus facile

HEXAGONAL COMPARTMENTS COMPARTIMENTOS HEXAGONALES COMPARTIMENTS HEXAGONAUX

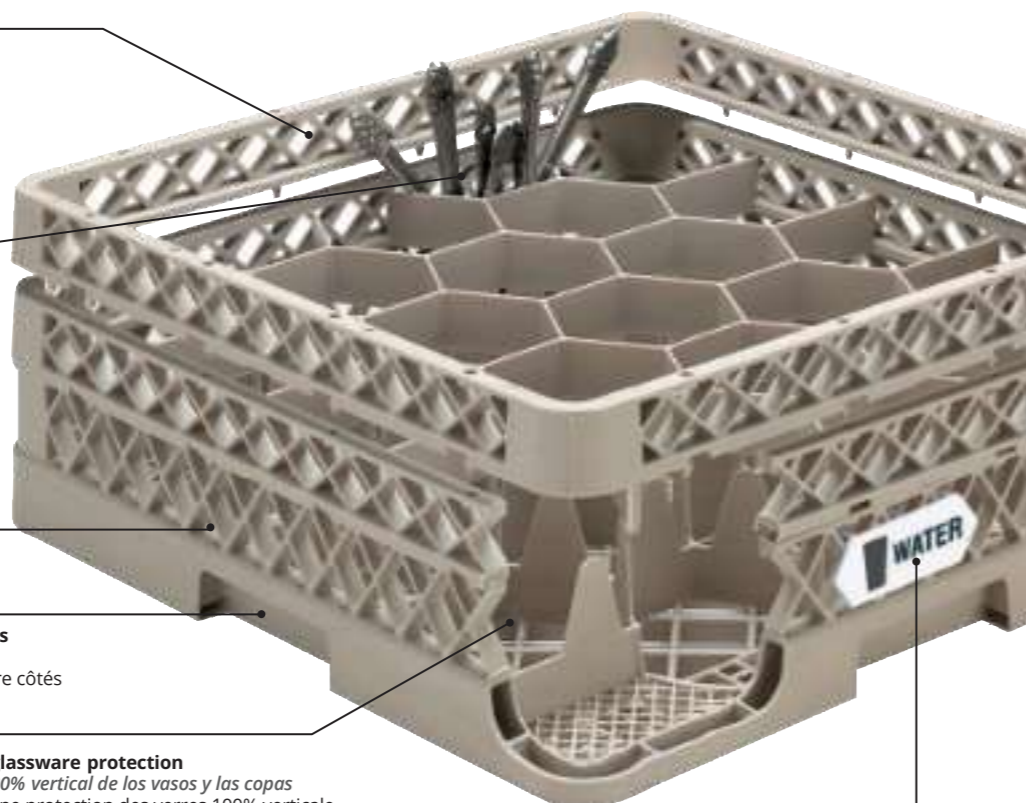

T-VERSION

CLIP Clip tags / Clip identificación / Clip d'identification

REF	Colour / Color	
1009-01	Brown	12
1009-02	Red	12
1009-03	Orange	12
1009-04	Blue	12
1009-05	White	12
1009-06	Black	12
1009-08	Yellow	12
1009-19	Green	12
1009-32	Beige	12

01	Brown / Marrón	06	Black / Negro
02	Red / Rojo	08	Yellow / Amarillo
03	Orange / Naranja	19	Green / Verde
04	Blue / Azul	32	Beige / Beige
05	White / Blanco		

Dishwasher racks selection

Selección cestas para vajilla
Sélection casiers à vaisselle

FLAP RACK®

T-VERSION

FLAPS



CLIP TAGS

CLIP IDENTIFICACIÓN
CLIP D'IDENTIFICATION



OPENED RACKS

CESTAS ABIERTAS
CASIERS OUVERTS



CLOSED RACKS

CESTAS CERRADAS
CASIERS FERMÉES



HALF-SIZE RACKS

CESTAS MEDIO TAMAÑO
CASIERS DEMI-TAILLE



DISASSEMBLY

DESMONTABLE
DÉMONTABLE



COMPARTMENTS

COMPARTIMENTOS
COMPARTIMENTS



COMPARTMENTS

COMPARTIMENTOS
COMPARTIMENTS



9.1 Open racks

Cestas abiertas
Casiers ouverts



∅ max. 151 mm

FLAP RACK



P5090
BASE 9 COMPART.

P5091
EXT. 9 COMPART.

REF	
P5090	6
P5091	12

∅ max. 122 mm

T-VERSION



TR18
BASE 12 COMPART.

TRJ
EXT. 12 COMPART.

REF	
TR18	6
TRJ	12

∅ max. 113 mm

FLAP RACK



P5160
BASE 16 COMPART.

P5161
EXT. 16 COMPART.

REF	
P5160	6
P5161	12

∅ max. 100 mm

T-VERSION



TR11
BASE 20 COMPART.

TRG
EXT. 20 COMPART.

REF	
TR11	6
TRG	12

∅ max. 89 mm

FLAP RACK



P5250
BASE 25 COMPART.

P5251
EXT. 25 COMPART.

REF	
P5250	6
P5251	12

Open racks 9.1

Cestas abiertas
Casiers ouverts



∅ max. 81 mm

T-VERSION

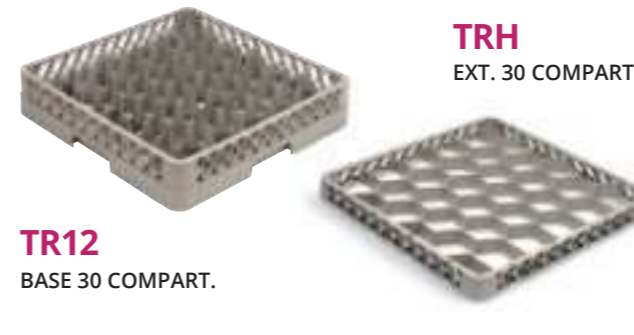

TR12
BASE 30 COMPART.

TRH
EXT. 30 COMPART.

REF	
TR12	6
TRH	12

∅ max. 73 mm

FLAP RACK



P5360
BASE 36 COMPART.

P5361
EXT. 36 COMPART.

REF	
P5360	6
P5361	12

∅ max. 70 mm

T-VERSION

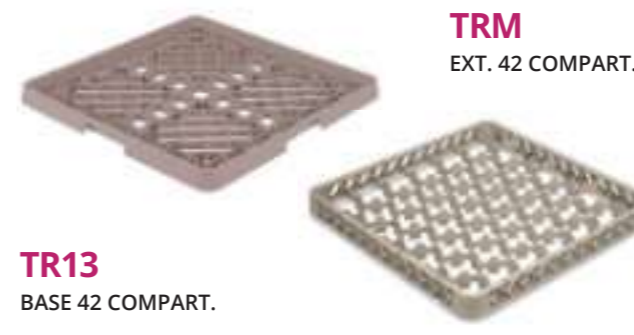

TR13
BASE 42 COMPART.

TRM
EXT. 42 COMPART.

REF	
TR13	6
TRM	12

∅ max. 63 mm

FLAP RACK



P5490
BASE 49 COMPART.

P5491
EXT. 49 COMPART.

REF	
P5490	6
P5491	12

DISHWASHER RACKS
CESTAS VAJILLA
CASIERS VASSELLE

DISHWASHER RACKS
CESTAS VAJILLA
CASIERS VASSELLE

9.2 Open assembled racks

Cestas montadas abiertas
Casiers montés ouverts



∅ max. 151 mm **9 COMPART.**

FLAP RACK



REF	∆max. (mm)	H (mm)*	
P5090 E1	120	140	1
P5090 E2	160	180	1
P5090 E3	200	220	1
P5090 E4	240	260	1
P5090 E5	280	300	1

∅ max. 122 mm **12 COMPART.**

T-VERSION



REF	∆max. (mm)	H (mm)*	
TR18 J	122	140	2
TR18 JJ	162	181	2
TR18 JJJ	200	222	2
TR18 JJJJ	240	262	2
TR18 JJJJJ	279	302	2

∅ max. 113 mm **16 COMPART.**

FLAP RACK



REF	∆max. (mm)	H (mm)*	
P5160 E1	120	140	1
P5160 E2	160	180	1
P5160 E3	200	220	1
P5160 E4	240	260	1
P5160 E5	280	300	1

∅ max. 100 mm **20 COMPART.**

T-VERSION



REF	∆max. (mm)	H (mm)*	
TR11 G	122	140	2
TR11 GGG	162	181	2
TR11 GGGG	200	222	2
TR11 GGGGG	240	262	2
TR11 GGGGGG	279	302	2

∅ max. 89 mm **25 COMPART.**

FLAP RACK



REF	∆max. (mm)	H (mm)*	
P5250 E1	120	140	1
P5250 E2	160	180	1
P5250 E3	200	220	1
P5250 E4	240	260	1
P5250 E5	280	300	1

Open assembled racks 9.2

Cestas montadas abiertas
Casiers montés ouverts



∅ max. 81 mm **30 COMPART.**

T-VERSION



REF	∆max. (mm)	H (mm)*	
TR12 H	122	140	2
TR12 HH	162	181	2
TR12 HHH	200	222	2
TR12 HHHH	240	262	2
TR12 HHHHH	279	302	2

∅ max. 70 mm **42 COMPART.**

T-VERSION



REF	∆max. (mm)	H (mm)*	
TR13 M	52	73	2
TR13 MM	91	114	2
TR13 MMM	130	156	2
TR13 MMMM	172	194	2

* Total set height
* Altura total del conjunto
* Hauteur totale ensemble

∅ max. 73 mm **36 COMPART.**

FLAP RACK



REF	∆max. (mm)	H (mm)*	
P5360 E1	120	140	1
P5360 E2	160	180	1
P5360 E3	200	220	1
P5360 E4	240	260	1
P5360 E5	280	300	1

∅ max. 63 mm **49 COMPART.**

FLAP RACK



REF	∆max. (mm)	H (mm)*	
P5490 E1	120	140	1
P5490 E2	160	180	1
P5490 E3	200	220	1
P5490 E4	240	260	1
P5490 E5	280	300	1

See products on
Ver productos en / Voir produits en page

P. 260

Trolley for dishwasher racks
Carro para cestas
Chariot pour casiers à vaisselle



9.3 Closed assembled racks

Cestas montadas cerradas
Casiers montés fermés



∅ max. 151 mm

FLAP RACK



P5090 F1
BASE 9 COMPART.

REF	
P5090 F1	6
P5091 F1	12

∅ max. 113 mm

FLAP RACK



P5160 F1
BASE 16 COMPART.

REF	
P5160 F1	6
P5161 F1	12

∅ max. 89 mm

FLAP RACK



P5250 F1
BASE 25 COMPART.

REF	
P5250 F1	6
P5251 F1	12

∅ max. 73 mm

FLAP RACK



P5360 F1
BASE 36 COMPART.

REF	
P5360 F1	6
P5361 F1	12

∅ max. 63 mm

FLAP RACK



P5490 F1
BASE 49 COMPART.

REF	
P5490 F1	6
P5491 F1	12

FLAP RACK

Indicate the colour code at the end of the reference.
Indicar el código de color al final de la referencia.
Indiquer le code de couleur a la fin de la référence.

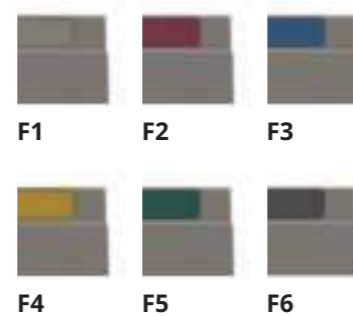

F1 F2 F3
F4 F5 F6

Closed assembled racks 9.3

Cestas montadas cerradas
Casiers montés fermés



∅ max. 151 mm 9 COMPART.

FLAP RACK



REF	∆max. (mm)	H (mm)*	
P5090 E1F1	120	140	1
P5090 E2F1	160	180	1
P5090 E3F1	200	220	1
P5090 E4F1	240	260	1
P5090 E5F1	280	300	1

∅ max. 89 mm 25 COMPART.

FLAP RACK



REF	∆max. (mm)	H (mm)*	
P5250 E1F1	120	140	1
P5250 E2F1	160	180	1
P5250 E3F1	200	220	1
P5250 E4F1	240	260	1
P5250 E5F1	280	300	1

∅ max. 63 mm 49 COMPART.

FLAP RACK



REF	∆max. (mm)	H (mm)*	
P5490 E1F1	120	140	1
P5490 E2F1	160	180	1
P5490 E3F1	200	220	1
P5490 E4F1	240	260	1
P5490 E5F1	280	300	1

∅ max. 113 mm 16 COMPART.

FLAP RACK



REF	∆max. (mm)	H (mm)*	
P5160 E1F1	120	140	1
P5160 E2F1	160	180	1
P5160 E3F1	200	220	1
P5160 E4F1	240	260	1
P5160 E5F1	280	300	1

∅ max. 73 mm 36 COMPART.

FLAP RACK



REF	∆max. (mm)	H (mm)*	
P5360 E1F1	120	140	1
P5360 E2F1	160	180	1
P5360 E3F1	200	220	1
P5360 E4F1	240	260	1
P5360 E5F1	280	300	1

* Total set height
* Altura total del conjunto
* Hauteur totale ensemble

Indicate the colour code at the end of the reference.
Indicar el código de color al final de la referencia.
Indiquer le code de couleur a la fin de la référence.

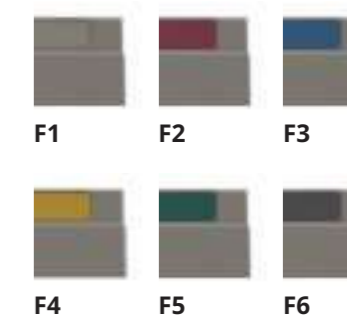

F1 F2 F3
F4 F5 F6

9.4 Complements

Complementos
Compléments



P5002 Open rack
Cesta universal
Panier universel

FLAP RACK®

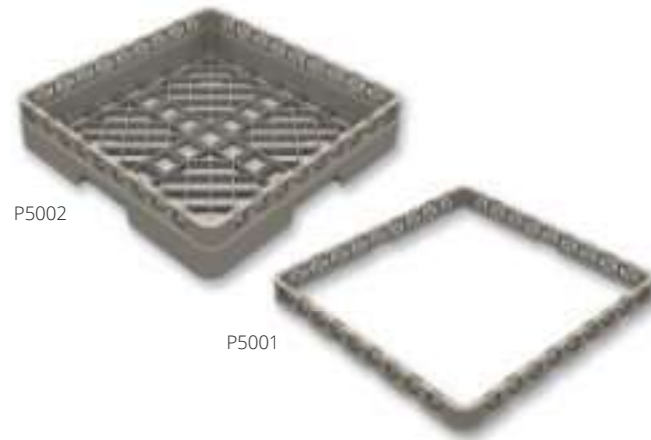

P5001 Compatible only with FlapRack® dishwasher racks.
Compatible sólo con las cestas FlapRack®.
Compatible uniquement avec les casiers de lavage FlapRack®.

TRA* Compatible only with T-Version dishwasher racks.
Compatible sólo con las cestas T-Version.
Compatible uniquement avec les casiers de lavage T-Version.

REF	
P5002	6
P5001	12
TRA*	12

TR33 Racks lid
Tapa para cestas
Couvercle pour paniers

FLAP RACK®



REF	
TR33	6

P5000 Plate, tray and cutlery racks
Cesta para platos, bandejas y cubiertos
Paniers pour plats, plateaux et couverts

FLAP RACK®

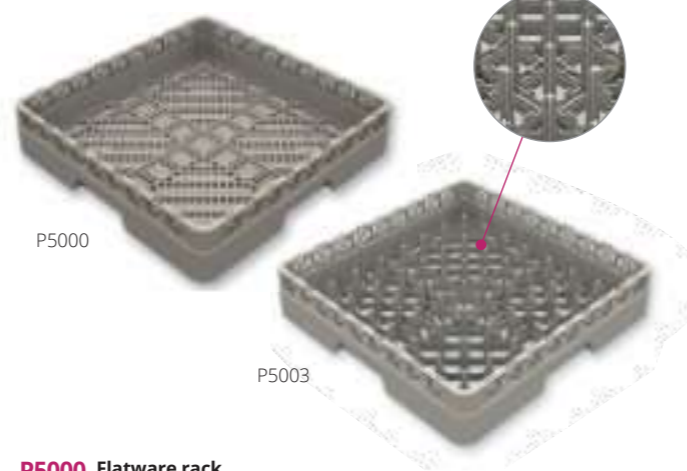

P5000 Flatware rack
Cesta para cubiertos
Panier a couverts

P5003 Plates and trays rack
Cesta para platos y bandejas
Panier pour assiettes et plateaux

REF	
P5000	6
P5003	6

P5062 Rack for cutlery storage
Cesta para almacenar cubiertos
Panier pour rangement couverts

FLAP RACK®

* Total set height
Altura total del conjunto
Hauteur totale ensemble



REF	max. (mm)	H (mm)*	Cutlery capacity Capacidad cubiertos Capacité couverts	
P5062	23	26	400	1

Complements 9.4

Complementos
Compléments



52640 8-Compartment flatware basket
Cesta para cubiertos de 8 compartimentos
Panier pour couverts 8 compartiments



NEW!

REF	W x D x H cm	
52640	46 x 19,6 x 18,5	4

52642 Plastic vertical flatware cylinder
Cestilla para cubiertos en plástico
Petit panier pour couverts en plastique

PI
Plastic



NEW!

REF	Ø cm	H cm	
52642	11,18	14,3	12

P5018 8-compartment flatware basket
Media cesta para cubiertos 8 compartimentos
Demi-panier pour couverts 8 compartiments

FLAP RACK®



REF		W x D x H cm	
P5018	With handle / Con asa / Avec anse	22 x 42,5 x 14,5	1
P5019	Without handle / Sin asa / Sans anse	22 x 42,5 x 14,5	6

52641 8-Comp. flatware basket with handles
Cesta para cubiertos de 8 compart. con asas
Panier pour couverts 8 compartiments avec poignées



NEW!

REF	W x D x H cm	
52641	46 x 19,6 x 18,5	4

99710 Stainless steel vertical flatware cylinder
Cestilla para cubiertos en acero inoxidable
Petit panier pour couverts inox

SS
Stainless steel



NEW!

REF	Ø cm	H cm	
99710	11,4	14,1	12

P5004 Flatware basket
Cestillo para cubiertos
Petit panier pour couverts

PI
Plastic

FLAP RACK®



REF		W x D x H cm	
P5004		10 x 10 x 14	52
52643		Ø 9,5 x 14,5	12

9.5 Plate racks

Cestas para platos
Casiers assiettes



FLAP RACK®

Plate crate: Perfect dish washing, storing and transporting for banquets, hotels, institutions and catering equipment rental companies. They minimize the plate breakage, labour and handling cost.

Cestas especiales para platos: Ideales para el lavado, almacenamiento y transporte de platos. Perfectas para banquetes, hoteles, colectividades y empresas de alquiler de material para la hostelería. Reducen las roturas de platos, minimizan el coste del transporte y manipulación.

Casiers pour assiettes: Idéales pour le lavage, stockage et transport d'assiettes. Parfaits pour banquetes, hôtels, collectivités et sociétés de location de matériel pour l'hôtellerie. Ce type de casiers permet de réduire le nombre d'assiettes cassées ainsi qu'une diminution des coûts de transport et manipulation.

Two types
Dos modalidades
Deux modèles

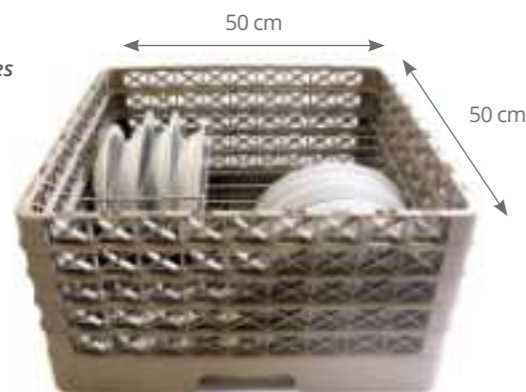

Faster wash and rinse.
Limpieza y secado rápido.
Nettoyage et séchage plus rapide.



More safety and hygienic storing and transporting.
Almacenamiento y transporte más seguro e higiénico.
Stockage et transport plus sûr et hygiénique.

Nine different grids
Nueve formatos de rejilla
Neuf grilles différentes

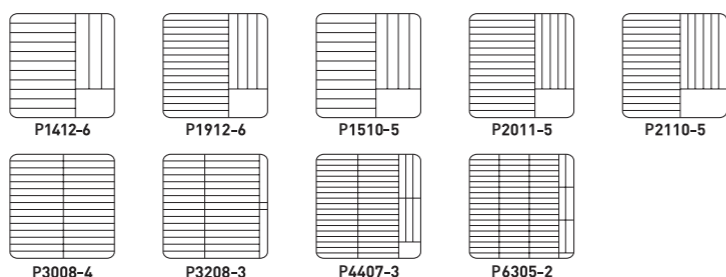

Extra protection, strength and durability.
Mayor protección, resistencia y durabilidad.
Plus grande protection, résistance et durabilité.

How to choose the appropriate plate crate:
Measure the plate diameter and height. You have then to choose between the 9 different grids according to the measures you get previously.

Como elegir la cesta de platos adecuada: Debe medir el diámetro y altura del plato. Con estos datos escoger, de las 9 combinaciones posibles, aquella que se ajuste más a las medidas del plato.

Comment choisir le casier pour assiettes: Mesurer le diamètre et la hauteur de l'assiette. Selon ces mesures choisir entre les 9 possibles combinaisons de grille qui s'adapte au mieux.



Plate racks 9.5

Cestas para platos
Casiers assiettes



P1412-6

Ø 27-31 cm

FLAP RACK



REF	I max. (cm)	Capacity plates Capacidad platos Capacité assiettes	
P1412-6	3,5	14	1
P1412-6 F1*	3,5	14	1

P1912-6

Ø 28-30,5 cm

FLAP RACK

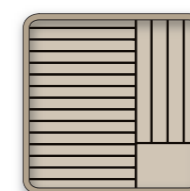

REF	I max. (cm)	Capacity plates Capacidad platos Capacité assiettes	
P1912-6	2,5	19	1
P1912-6 F1*	2,5	19	1

P2110-5

Ø 23-25 cm

FLAP RACK

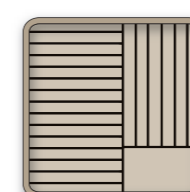

REF	I max. (cm)	Capacity plates Capacidad platos Capacité assiettes	
P2110-5	2,5	21	1
P2110-5 F1*	2,5	21	1

P3208-3

Ø 12-19 cm

FLAP RACK



REF	I max. (cm)	Capacity plates Capacidad platos Capacité assiettes	
P3208-3	2,5	32	1
P3208-3 F1*	2,5	32	1

P1510-5

Ø 23-28 cm

FLAP RACK



REF	I max. (cm)	Capacity plates Capacidad platos Capacité assiettes	
P1510-5	3,5	15	1
P1510-5 F1*	3,5	15	1

P2011-5

Ø 25-28 cm

FLAP RACK



REF	I max. (cm)	Capacity plates Capacidad platos Capacité assiettes	
P2011-5	2,5	20	1
P2011-5 F1*	2,5	20	1

P3008-4

Ø 20-22 cm

FLAP RACK



REF	I max. (cm)	Capacity plates Capacidad platos Capacité assiettes	
P3008-4	2,5	30	1
P3008-4 F1*	2,5	30	1

FLAP RACK

* Closed racks
* Cestas cerradas
* Casiers fermés

Indicate the colour code at the end of the reference.
Indicar el código de color al final de la referencia.
Indiquer le code de couleur a la fin de la référence.

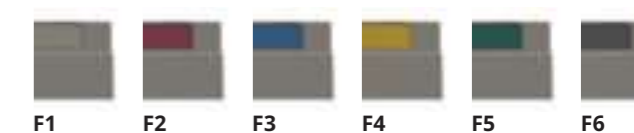

DISHWASHER RACKS
CESTAS VAJILLA
CASIERS VASSELLE

DISHWASHER RACKS
CESTAS VAJILLA
CASIERS VASSELLE

9.5 Plate racks

Cestas para platos
Casiers assiettes



P4407-3 Ø 15-18 cm

FLAP RACK

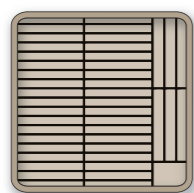

REF	max. (cm)	Capacity plates Capacidad platos Capacité assiettes	
P4407-3	2	44	1
P4407-3 F1*	2	44	1

TR23 Open tray rack
TR30 Cesta para grandes bandejas
Panier pour grands plateaux

T-VERSION



* Capacity for 4 full-size extended trays and also for isothermal trays
Ref. 919000 (page 220)
Capacidad para 4 bandejas extendidas de tamaño completo y también para bandejas isotérmicas Ref. 919000 (pag 220)
Capacité pour 4 plateaux longs de grande taille et également pour des plateaux isothermes Réf. 919000 (page 220).

REF	H cm		
	Inside / Interior / Intérieure	Outside / Exterior / Extérieure	
TR23*	13,3	13,3	1
TR30	8,3	10,2	1

FLAP RACK

* Closed racks
* Cestas cerradas
* Paniers fermés

Indicate the colour code at the end of the reference.
Indicar el código de color al final de la referencia.
Indiquer le code de couleur a la fin de la référence.

P6305-2 Ø 10-12,8 cm

FLAP RACK

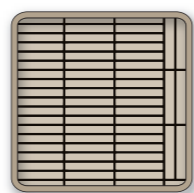

REF	max. (cm)	Capacity plates Capacidad platos Capacité assiettes	
P6305-2	2,5	63	1
P6305-2 F1*	2,5	63	1

TR21 GN, isothermal trays and plates rack
TR22 Cesta para bandejas isotérmicas, GN y platos
Panier pour plateaux isothermes, GN et assiettes

T-VERSION



TR21
8 Compartments
Distance between compart. 80 mm
No aptas para bandejas isotérmicas
Ne convient pas aux bacs isothermiques
Ref. 919000 (pag 220)

TR22
5 Compartments
Distance between compart. 75 mm
No aptas para bandejas isotérmicas
Ne convient pas aux bacs isothermiques
Ref. 919000 (pag 220)

Open end rack / Cesta de extremo abierto / Casier ouvert à l'extrémité

REF	H cm		
	Inside / Interior / Intérieure	Outside / Exterior / Extérieure	
TR21	8,3	12,1	1
TR22	13,3	13,3	1

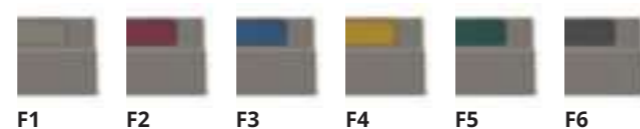

Referenceguide for bases and extensions

Guía de selección para bases y extensiones
Guide de sélection pour bases et rehausses

HEIGHT OF FULL-SIZE RACKS
ALTURA DE LAS CESTAS DE TAMAÑO COMPLETO
HAUTEUR DES CASIERS GRANDE TAILLE

HEIGHT OF HALF-SIZE RACKS
ALTURA DE LAS CESTAS DE MEDIO TAMAÑO
HAUTEUR DES CASIERS DEMI-TAILLE

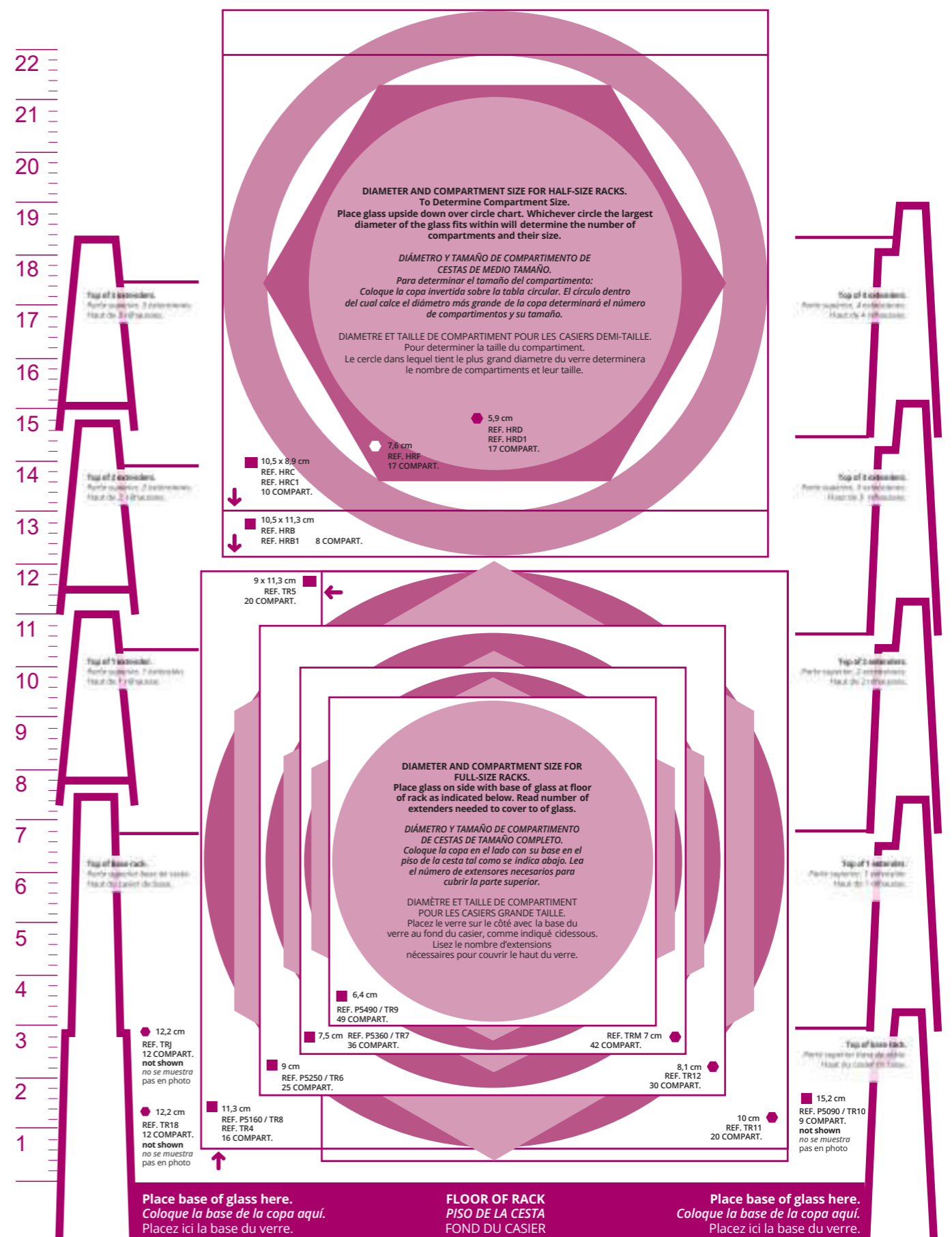

DISHWASHER RACKS
CESTAS VAJILLA
CASIERS VAISSELLE

DISHWASHER RACKS
CESTAS VAJILLA
CASIERS VAISSELLE

10 Trolleys

Carros
Chariots



10.1 ALUMINIUM SERVING TROLLEYS 244

CARROS DE SERVICIO ALUMINIO
CHARIOTS DE SERVICE EN ALUMINIUM

10.2 ST/STEEL SERVING TROLLEYS 246

CARROS DE SERVICIO ACERO INOXIDABLE
CHARIOTS DE SERVICE EN ACIER INOXYDABLE

10.3 ST/STEEL RAIL TROLLEYS 250

CARROS GUÍAS EN ACERO INOXIDABLE
CHARIOTS À GLISSIÈRE EN ACIER INOXYDABLE

16.4 SPECIAL TROLLEYS 257

CARROS ESPECIALES
CHARIOTS SPÉCIAUX

10.1 Aluminium serving trolleys

Carros de servicio aluminio
Chariots de service en aluminium

P6411 Multi purpose cart Carro de servicio Chariot de service

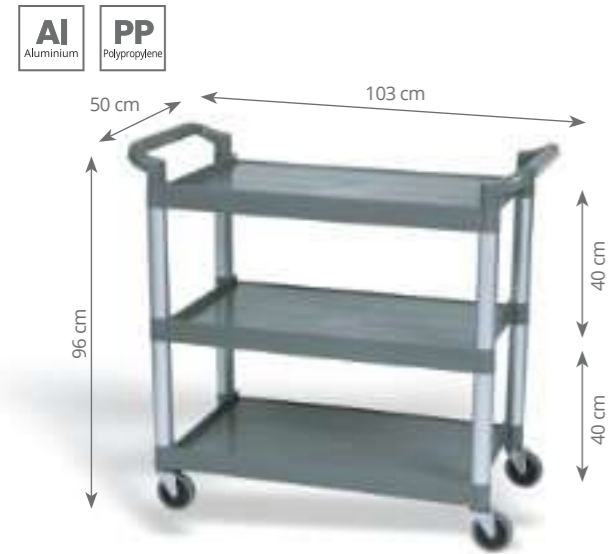

Maximum weight load 120 kgs
Carga máxima 120 kgs
Charge maximale 120 kgs

Aluminium supports
Soportes de aluminio
Supports en aluminium

REF	Shelf dimension Dim. Estante / Dim. Niveau cm	
P641100	78 x 48,5	1

P640 Set trolley Conjunto carro Ensemble chariot

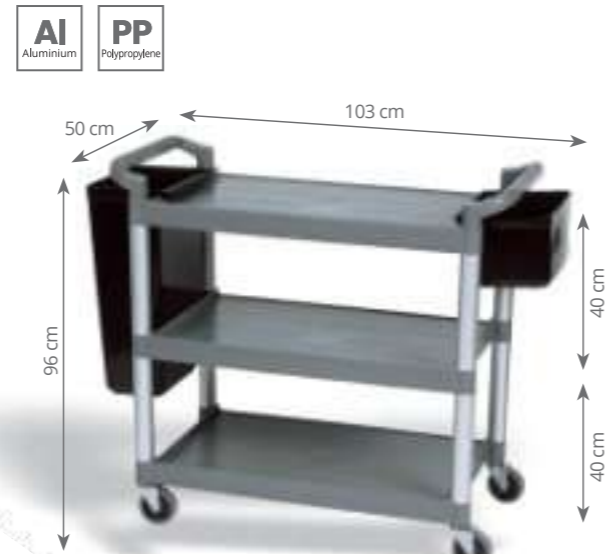

REF	Shelf dimension Dim. Estante / Dim. Niveau cm	
P640000	78 x 48,5	1

P642 Silverware container Contenedor para cubiertos Conteneur pour couverts



REF	cm	Lts	
P642000	32 x 19,5 x 16,5	9	1

P643 Refuse container Contenedor para desperdicios Conteneur pour déchets



REF	cm	Lts	
P643000	33,5 x 23 x 56	80	1

Aluminium serving trolleys 10.1

Carros de servicio aluminio
Chariots de service en aluminium



97006 Multi purpose cart Carro de servicio Chariot de service



Textured shelf surface reduces product shifting
La superficie texturizada del estante reduce el desplazamiento del producto
La surface texturée de l'étagère réduit le déplacement du produit

Maximum weight load 135 kgs
Carga máxima 135 kgs
Charge maximale 135 kgs

REF	Shelf dimension Dim. Estante / Dim. Niveau cm	W x D x H cm	
97006	66 x 41,3	84 x 43 x 94	1
97007	75 x 49	102,2 x 50,5 x 94	1

97004 Multi purpose cart Carro de servicio Chariot de service



Textured shelf surface reduces product shifting
La superficie texturizada del estante reduce el desplazamiento del producto
La surface texturée de l'étagère réduit le déplacement du produit

Maximum weight load 135 kgs
Carga máxima 135 kgs
Charge maximale 135 kgs

REF	Shelf dimension Dim. Estante / Dim. Niveau cm	W x D x H cm	
97004	66 x 41,3	84 x 43 x 94	1
97005	75 x 49	102,2 x 50,5 x 94	1

P8090 Aluminium clearing trolley Carro aluminio desembarace Chariot débarrasage en aluminium



EXCLUSIVE

Racks adjustable to 1/1 GN containers and FLAP-RACK® (500 x 500 mm).
Maximum load: 150 Kg and max. per level 75 Kg.

Medidas de estantes adaptables a cubetas GN 1/1 y cestas FLAP-RACK® (500 x 500 mm). Carga máxima: total 150 Kg y con un máximo de 75 Kg por estante.

Clayettes adaptables à des bacs GN 1/1 et à casiers à vaisselle FLAP-RACK® (500 x 500 mm). Charge maximale: total 150 Kg et 75 Kg par niveau.

REF	Shelf dimension Dim. Estante / Dim. Niveau cm	
P80900	87 x 55,5	1

10.2 St/steel serving trolleys

Carros de servicio acero inoxidable
Chariots de service en acier inoxydable



P8024 St/steel serving trolley

Carro servicio acero inox
Chariot service en acier inox



1.5 mm thick St/Steel tubular frame
Estructura tubular en acero inox de 1.5 mm espesor
Structure tubulaire en acier inoxydable 1.5 mm. épaisseur

Total maximum load 240 kg. Max. load per level 80 kg
Carga máxima total 240 KG.
Carga máxima por estante 80 kg
Charge maximale total 240 kg.
Charge maximale per niveau 80 kg

12 cm diam. Revolving casters. Two with brakes
Ruedas giratorias de 12 cm diámetro. Dos con frenos
Roues giratoires de 12 cm diam.
Deux avec freins

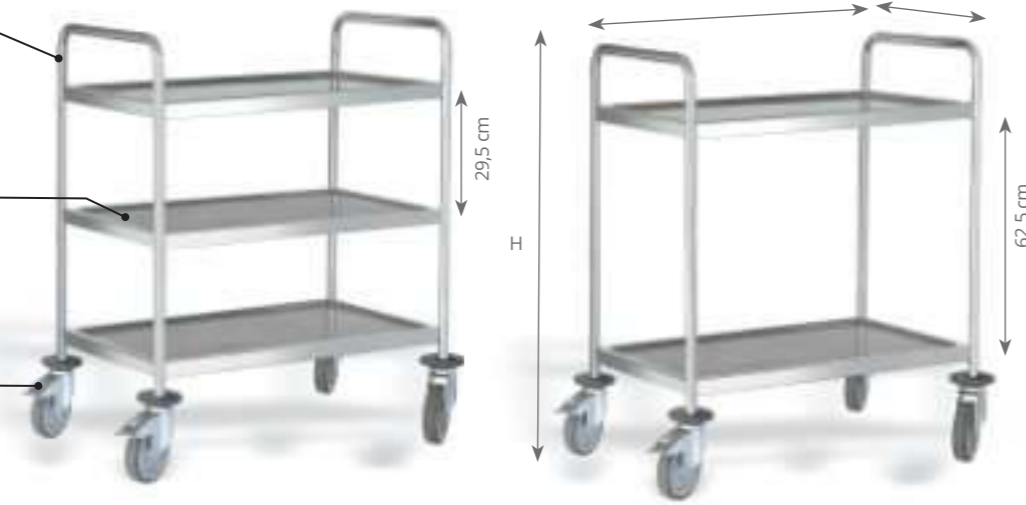

REF	Levels Estantes Niveaux	Shelf dimension Dim. Estante / Dim. Niveau cm	W x D x H cm	
P80240	2	80 x 50	88 x 58 x 101,5	1
P80250	2	90 x 50	98 x 58 x 101,5	1
P80260*	2	100 x 60	108 x 68 x 101,5	1
P80270	3	80 x 50	88 x 58 x 101,5	1
P80280	3	90 x 50	98 x 58 x 101,5	1
P80290*	3	100 x 60	108 x 68 x 101,5	1
P80300	4	80 x 50	88 x 58 x 130	1
P80310	4	90 x 50	98 x 58 x 130	1
P80320*	4	100 x 60	108 x 68 x 130	1

* Thicker shelves
Estantes de chapa de mayor espesor
Plateaux plus épais

Available also on polyamide castors.
Disponible también con ruedas poliamida.
Disponible aussi avec roulettes polyamide.



P80374 Cutlery dispenser for serving trolley

Cubertero para carro servicio
Ramasse-couverts pour chariot service



REF	Mod	H cm	
P80374	GN 1/3	15	1

P8068 St/Steel clearing trolley

Carro desembarace inox
Chariot de débarrassage en inox



Available also on polyamide castors.
Disponible también con ruedas poliamida.
Disponible aussi avec roulettes polyamide.

1/2 Gastronorm container not included.
No incluye cubeta Gastronorm 1/2.
Bac Gastronorme 1/2 non inclus.
Ø 165 mm

REF	Levels Estantes Niveaux	Shelf dimension Dim. Estante / Dim. Niveau mm	
P80680	2	1.000 x 600	1

St/steel serving trolleys 10.2

Carros de servicio acero inoxidable
Chariots de service en acier inoxydable



P80282 Paneled serving trolley

Carro servicio panelado
Chariot service panelé



1.5 mm thick St/Steel tubular frame
Estructura tubular en acero inox de 1.5 mm espesor
Structure tubulaire en acier inoxydable 1.5 mm. épaisseur

Paneled
Panelado
Panelé



Total maximum load 240 kg. Max. load per level 80 kg
Carga máxima total 240 kg
Carga máxima por estante 80 kg
Charge maximale total 240 kg
Charge maximale per niveau 80 kg

12 cm diam. Revolving casters. Two with brakes
Ruedas giratorias de 12 cm diámetro. Dos con frenos
Roues giratoires de 12 cm diam.
Deux avec freins

REF	Shelf dimension Dim. Estante / Dim. Niveau cm	
P80282	90 x 50	1

97181 Bussing cart

Carro de transporte
Chariot de transport



Bins not included
Cubetas no incluidas
Bacs non inclus.

Durable stainless steel construction and ABS handle provide years of service.

La construcción duradera de acero inoxidable y el mango de ABS proporcionan años de servicio.

La construction durable en acier inoxydable et la poignée en ABS offrent des années de service.

Black vinyl finish creates an attractive appearance

El acabado de vinilo negro crea un aspecto atractivo

La finition en vinyle noir crée un look attrayant

Strong swivel casters ensure swift maneuvering

Las ruedas giratorias fuertes garantizan una maniobra rápida

Des roues pivotantes robustes garantissent une manœuvre rapide

REF	Shelf dimension Dim. Estante / Dim. Niveau cm	
97181	69 x 45	1

10.2 St/steel serving trolleys

Carros de servicio acero inoxidable
Chariots de service en acier inoxydable



Total maximum load 240 kg.
Max. load per level 80 kg
Carga máxima total 240 KG.
Carga máxima por estante 80 kg
Charge maximale total 240 kg.
Charge maximale per niveau 80 kg



12 Cm diam. Revolving casters. Two with brakes
Ruedas giratorias de 12 cm diámetro. Dos con frenos
Roues giratoires de 12 cm diam. Deux avec freins

P8033 Disassembled trolley
Carro desmontable
Chariot démontable

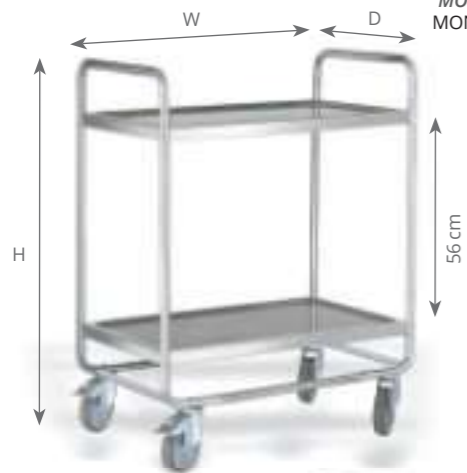

Muy robustos y sólidos
Very strong and resistant once assembled
Très robustes et solides une fois montés

Se entregan desmontados.
Delivered flatpacked.
Livrés démontés.

REF	Levels Estantes Niveaux	Shelf dimension Dim. Estante Dim. Niveau cm	W x D x H cm	📦
P80330	2	80 x 50	81 x 54,5 x 104	1
P80340	2	90 x 50	91 x 54,5 x 104	1
P80350	3	80 x 50	81 x 54,5 x 104	1
P80360	3	90 x 50	91 x 54,5 x 104	1

P8096 Light disassembled trolley
Carro desmontable ligero
Chariot démontable légère



Ruedas acero Ø 100 mm. Dos con freno.
Castors Ø 100 mm. Two with brakes.
Roulettes Ø 100 mm. Deux avec freins.

ECONOMIC LINE
GAMA ECONÓMICA
GAMME ECONOMIQUE

REF	Levels Estantes Niveaux	Shelf dimension Dim. Estante Dim. Niveau cm	W x D x H cm	📦
P80960	2	83 x 51	93 x 61 x 93,5	1
P80961	3	83 x 51	93 x 61 x 93,5	1

St/steel serving trolleys 10.2

Carros de servicio acero inoxidable
Chariots de service en acier inoxydable



P8094 Serving trolley with guard-rail shelf
Carro servicio con barandilla
Chariot service avec galerie

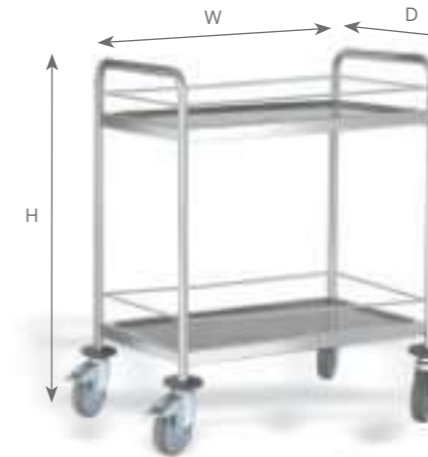

Available also on polyamide castors. Please ask for price
Disponible también con ruedas poliamida. Consultar precio
Disponible aussi avec roulettes polyamide. Consulter prix

REF	Levels Estantes Niveaux	Shelf dimension Dim. Estante Dim. Niveau cm	W x D x H cm	📦
P80940	2	80 x 50	88 x 58 x 101,5	1
P80941	3	80 x 50	88 x 58 x 101,5	1

97168 Three-shelf tubular cart
Carro tubular de 3 estantes
Chariot tubulaire à 3 étagères



97208 Three-shelf heavy-duty stainless steel cart
Carro de servicio de 3 niveles
Chariot service à trois étagères



400 kg capacity is distributed between the shelves.
Two 10 cm wivel casters and two 20 cm front wheels ensure swift maneuvering.
Extended-height stainless steel handles feature a comfort coating.

La capacidad de 400 kg se distribuye entre las estanterías.
Dos ruedas giratorias de 10 cm y dos ruedas delanteras de 20 cm garantizan una maniobra rápida. Los mangos de acero inoxidable de altura extendida cuentan con un revestimiento de confort.

La capacité de 400 kg est répartie entre les rayonnages. Deux roues pivotantes de 10 cm et deux roues avant de 20 cm garantissent une manœuvre rapide. Les poignées en acier inoxydable à hauteur prolongée sont dotées d'un revêtement de confort.

REF	Shelf dimension Dim. Estante Dim. Niveau cm	📦
97208	89 x 58,4	1

REF	Shelf dimension Dim. Estante Dim. Niveau cm	📦
97168	85 x 54	1

10.3 St/steel rail trolleys

Carros guías en acero inoxidable
Chariots à glissières en acier inoxydable



P8043 17 rails trolley for GN pans
Carro 17 guías GN
Chariot 17 glissières pour bacs GN



Available also on polyamide castors. Please ask for price.
Disponibile también con ruedas poliamida. Consultar precio.
Disponible aussi avec roulettes polyamide. Consulter prix.

REF	Entrance / Entrada / Entré cm	
P80430	32,5	1

P8067 Double rail trolley 17 x 2 for 1/1 GN pans
Carro doble 17 x 2 guías 1/1
Chariot double 17 x 2 glissières pour bacs GN 1/1



Available also on polyamide castors. Please ask for price.
Disponibile también con ruedas poliamida. Consultar precio.
Disponible aussi avec roulettes polyamide. Consulter prix.

REF	Entrance / Entrada / Entré cm	
P80670	32,5	1

P80641 Disposable trolley covers dispenser
Dispensador para fundas de carro
Distributeur pour housses de chariot



NEW!

REF		
P80641		1

P8061 Disposable covers for trolleys
P8062 Fundas desechables de polietileno para carros
P8063 Housses jetables pour chariots



Pack / Rollo / Rouleau 100 u

Medium density polyethylene. For high trolleys.
Polietileno de densidad media. Para carros altos.
Poliéthylène de densité moyenne. Pour chariots hauts.

REF		
P80610	for trolley 1/1 / para carro 1/1 / pour chariot 1/1	1
P80620	for trolley 2/1 / para carro 2/1 / pour chariot 2/1	1
P80630	for pastry trolley 600 x 400 / para carro pastelería 600 x 400 / pour chariot pâtisserie 600 x 400	1

St/steel rail trolleys 10.3

Carros guías en acero inoxidable
Chariots à glissières en acier inoxydable



P8047 Disassembled trolley 17 rails for GN pans
Carro desmontable 17 guías GN
Chariot démontable 17 glissières pour bacs GN



Available also on polyamide castors. Please ask for price.
Disponibile también con ruedas poliamida. Consultar precio.
Disponible aussi avec roulettes polyamide. Consulter prix.

REF	Entrance / Entrada / Entré cm	
P80470	32,5	1

P8097 Light Disassembled trolley 15 rails for GN pans
Carro desmontable ligero 15 guías GN
Chariot démontable léger 15 glissières pour bacs GN



Castors Ø 120 mm. Two with brakes.
Ruedas acero Ø 120 mm. Dos con freno.
Roulettes Ø 120 mm. Deux avec freins.

ECONOMIC LINE
GAMA ECONÓMICA
GAMME ECONOMIQUE

REF	Entrance / Entrada / Entré cm	
P80970	32,5	1

P8052 Stackable trolley 17 rails for GN pans
Carro encastrable 17 guías GN
Chariot emboîtable 17 glissières pour bacs GN



Stackble
Encastrable
Emboîtable

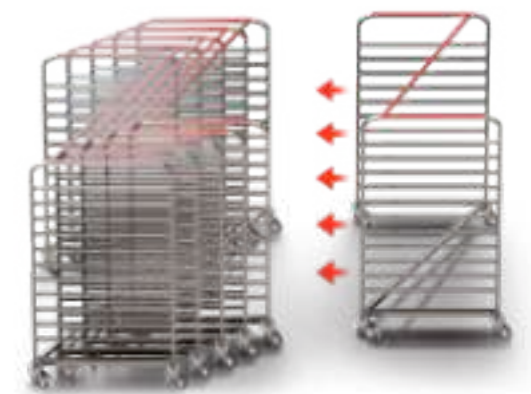

Available also on polyamide castors. Please ask for price.
Disponibile también con ruedas poliamida. Consultar precio.
Disponible aussi avec roulettes polyamide. Consulter prix.

REF	Entrance / Entrada / Entré cm	
P80520	32,5	1

10.3 St/steel rail trolleys

Carros guías en acero inoxidable
Chariots à glissières en acier inoxydable



P8044 17 rails trolley for GN pans
Carro 17 guías GN
Chariot 17 glissières pour bacs GN



Available also on polyamide castors. Please ask for price.
Disponible también con ruedas poliamida. Consultar precio.
Disponible aussi avec roulettes polyamide. Consulter prix.

REF	Entrance / Entrada / Entré cm	
P80440	53	1

P8048 Disassembled trolley 17 rails for GN pans
Carro desmontable 17 guías GN
Chariot démontable 17 glissières pour bacs GN



Available also on polyamide castors. Please ask for price.
Disponible también con ruedas poliamida. Consultar precio.
Disponible aussi avec roulettes polyamide. Consulter prix.

REF	Entrance / Entrada / Entré cm	
P80480	53	1

P8051 Stackable trolley 17 rails for GN pans
Carro encastrable 17 guías GN
Chariot emboîtable 17 glissières pour bacs GN



Available also on polyamide castors. Please ask for price.
Disponible también con ruedas poliamida. Consultar precio.
Disponible aussi avec roulettes polyamide. Consulter prix.

REF	Entrance / Entrada / Entré cm	
P80510	53	1

St/steel rail trolleys 10.3

Carros guías en acero inoxidable
Chariots à glissières en acier inoxydable



P8084 Pastry trolley
P8085 Carro pastelería
P8046 Chariot pâtisserie



Entrance 400 mm
Entrada 400 mm
Entrée 400 mm

Available also on polyamide castors. Please ask for price.
Disponible también con ruedas poliamida. Consultar precio.
Disponible aussi avec roulettes polyamide. Consulter prix.

REF	Nr. of Levels Nº Guías Num. Niveaux	Size of rails Medida guías Dimensions glissières cm	Distance between levels Distancia entre guías Espace entre niveaux cm	
P80840	15	60 x 40	8,5	1
P80850	20	60 x 40	7,0	1
P80460	30	60 x 40	4,5	1

P8087 Disassembled rail trolley for bakery
P8088 Carro desmontable bandejas pastelería
P8050 Chariots démontable pour plaques à pâtisserie



Entrance 400 mm
Entrada 400 mm
Entrée 400 mm

Available also on polyamide castors. Please ask for price.
Disponible también con ruedas poliamida. Consultar precio.
Disponible aussi avec roulettes polyamide. Consulter prix.

REF	Nr. of Levels Nº Guías Num. Niveaux	Size of rails Medida guías Dimensions glissières cm	Distance between levels Distancia entre guías Espace entre niveaux cm	
P80870	15	60 x 40	8,5	1
P80880	20	60 x 40	7,0	1
P80500	30	60 x 40	4,5	1

See products on / Ver productos en / Voir produits en page

P. 154

GN Pastry Pan
Cubeta GN Pastelería
Bac GN pâtisserie



10.3 St/steel rail trolleys

Carros guías en acero inoxidable
Chariots à glissières en acier inoxydable



P8081 Defrost trolley 9 rails
Carro descongelación 9 guías
Chariot à dégivrage 9 glissières

PATENTED EXCLUSIVE

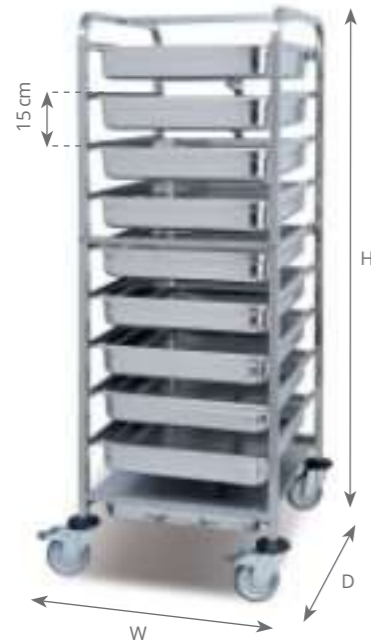

Drain in each shelf
Cada nivel tiene un desagüe
Chaque niveau est pourvu d'une évacuation

Tray to collect thawing condensate
Cubeta para recoger el agua de descongelación
Bac pour recueillir l'eau de décongélation

Space saver while foodstuff defrost.
Ahorro de espacio en el proceso de descongelado de los alimentos.
Economie d'espace pendant le dégivrage des aliments.
Available also on polyamide castors. Please ask for price.
Disponible también con ruedas poliamida. Consultar precio.
Disponible aussi avec roulettes polyamide. Consulter prix.

REF	Mod	W x D x H cm	Entrance Entrada Entré cm	
P80810	GN 2/1	66,5 x 75,5 x 171	53,0	1
P80813	GN 1/1	45,5 x 63,0 x 171	32,5	1

P80811 Special GN container for defrost trolley
Cubeta especial GN para carro descongelación
Bac GN spécial pour chariot dégivrage



Container with drainer hole.
Cubeta con desagüe.
Bac avec dégorgeement.

REF	Mod	cm	Lts	H cm	
P80811	GN 2/1	65 x 53	28,9	10	1
P80814	GN 1/1	53 x 32,5	14,2	10	1

P215 / P115 Perforated bottom
Fondo perforado para cubeta
Egouttoir pour bac



¹ Recommended for item code P80811
Recomendado para ref. P80811
Recommandé pour réf. P80811
² Recommended for item code P80814
Recomendado para ref. P80814
Recommandé pour réf. P80814

REF	Mod	
P215000 ¹	GN 2/1	1
P115000 ²	GN 1/1	1

St/steel rail trolleys 10.3

Carros guías en acero inoxidable
Chariots à glissières en acier inoxydable



P8095 Self-service trolley 12 rails
Carro self-service 12 guías
Chariot self-service 12 glissières

P8096 Self-service trolley 24 rails
Carro self-service 24 guías
Chariot self-service 24 glissières



New 12 cm width rails
Nuevas guías de 12 cm de ancho
Nouveaux rails de 12 cm de large



* With two side panels made of aluminium+composite .
* Con dos paneles laterales composite+aluminio.
* Avec deux panneaux latéraux en composite+aluminium.

REF	
P80950	1
P80951*	1

* With two side panels made of aluminium+composite .
* Con dos paneles laterales composite+aluminio.
* Avec deux panneaux latéraux en composite+aluminium.



REF	
P80965	1
P80966*	1

* With two side panels made of aluminium+composite .
* Con dos paneles laterales composite+aluminio.
* Avec deux panneaux latéraux en composite+aluminium.

See products on / Ver productos en / Voir produits en page

P. 222

Polypropylene fast food trays
Bandejas de polipropileno para comida rápida
Plateaux de restauration rapide en polypropylène



10.3 St/steel rail trolleys

Carros guías en acero inoxidable
Chariots à glissières en acier inoxydable



P8091 Double fast-food tray trolley 12 rails
Carro doble para bandejas fast-food 12 guías
Chariot double pour plateaux fast-food 12 glissières



Suitable for trays 480 x 370 mm
Ideal para bandejas 480 x 370 mm
Ideal pour plateaux 480 x 370 mm

Entrance 480 mm
Entrada 480 mm
Entrée 480 mm

Available also on polyamide castors. Please ask for price.
Disponibile también con ruedas poliamida. Consultar precio.
Disponible aussi avec roulettes polyamide. Consulter prix.

REF	Size of rails Medida guías Dimensions glissières cm	
P80910	48 x 80	1

P925 Transport trolley for isothermal trays
Carro transporte bandejas isotérmicas
Chariot transport plateaux isothermes



Trolley made of St/Steel and plastic rails. Perfect for many different size trays transport thanks to the special rail design. Soundproof revolving castors Ø 125 mm.

Carro fabricado en acero inoxidable y guías de plástico. Ideal para el transporte de bandejas de distintas medidas, gracias al diseño especial de sus guías. Ruedas giratorias insonoras de Ø 125 mm.

Chariot fabriqué en acier inoxydable et glissières en plastique. Idéal pour le transport des plateaux de différentes mesures, grâce au design spécial des glissières. Roulettes insonores de Ø 125 mm.

REF	Nr. of Levels Nº Guías Num. Niveaux	Size of rails Medida guías Dimensions glissières cm	W x D x H cm	
P925001	10	55 x 37,5	50 x 62 x 152	1
P925002	20	55 x 37,5	92 x 62 x 152	1

See products on / Ver productos en / Voir produits en page

P. 220

Isothermal tray
Bandeja isotérmica
Plateau Isotherme



Special trolleys 10.4

Carros especiales
Chariots spéciaux



P80790 Plate trolley
Carro para platos
Chariot à vaisselle



REF	W x D x H cm	
P80790	58 x 71 x 177,5	1

The distance between levels is 5,8 cm
Distancia entre niveles 5,8 cm.
Distance entre les niveaux 5,8 cm.

Carbon steel with anti-corrosion coating
Acero al carbono con recubrimiento anticorrosivo
Acier au carbone avec revêtement anti-corrosion

Capacity for 100 dishes. Different sizes of dishes can be combined thanks to its adjustable system.

Capacidad para 100 platos. Se pueden combinar diferentes tamaños de platos gracias a su sistema ajustable.

Capacité pour 100 assiettes. Différentes tailles de plats peuvent être combinées grâce à son système réglable.

(Ø máx. 34,5cm)

Strong welded structure handle for easy transport

Resistente estructura soldada con asa para fácil transporte.
Structure soudée robuste avec poignée pour un transport facile.

4 Wheels of 125mm with bumpers. 2 wheels brakes included.

4 ruedas de 12,5 cm con parachoques. 2 ruedas con freno.
4 roues de 125 mm avec pare-chocs. 2 roulettes avec freins

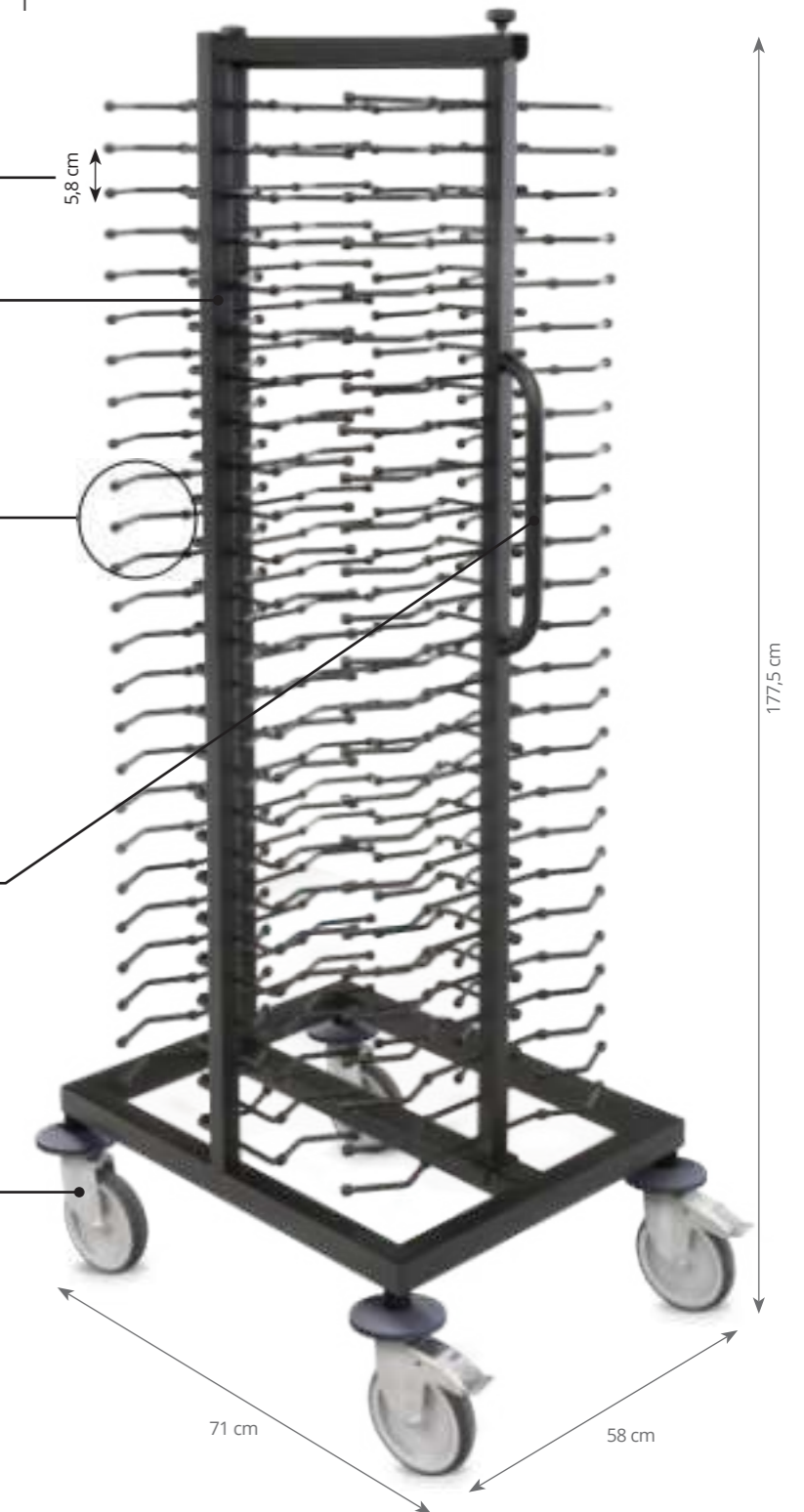

10.4 Special trolleys

Carros especiales
Chariots spéciaux



P8039 GN containers transport trolley
Carro porta cubetas GN
Chariot transport bacs GN



GN containers not included.
No incluye cubetas GN.
Bacs GN non inclus.

Available also on polyamide castors. Please ask for price.
Disponible también con ruedas poliamida. Consultar precio.
Disponible aussi avec roulettes polyamide. Consulter prix.

REF	1
P80390	1

P8038 2/1 GN transport trolley
Carro porta cubeta GN 2/1
Chariot transport bac GN 2/1



GN containers not included.
No incluye cubetas GN.
Bacs GN non inclus.

Available also on polyamide castors. Please ask for price.
Disponible también con ruedas poliamida. Consultar precio.
Disponible aussi avec roulettes polyamide. Consulter prix.

REF. P80.390 / P80.380
Transport trolley for GN containers
Carro transporte para cubetas GN
Chariots de transport pour bacs GN

Made of St/Steel. Perfect for storing and transporting large quantities of prepared food and sauces.

Fabricados en acero inoxidable. Ideales para el almacenaje y transporte de alimentos preparados y salsas en grandes cantidades.
Fabriqués en acier inoxydable. Idéales pour le stockage et le transport d'aliments cuisinés et sauces en grandes quantités.

REF	1
P80380	1

P8054 Tray transport trolley 7 rails
Carro transporte bandejas 7 guías
Chariot transport plateaux 7 glissières



Ref. P80.540 Ref. P80.780

Available also on polyamide castors. Please ask for price.
Disponible también con ruedas poliamida. Consultar precio.
Disponible aussi avec roulettes polyamide. Consulter prix.

REF	Size of rails Medida guías Dimensions glissières cm	W x D x H cm	Distance between levels Distancia entre guías Espace entre niveaux cm	1
P80540	GN 1/1	45,5 x 63,5 x 90	7,5	1
P80550	GN 2/1	66 x 75 x 90	7,5	1
P80560	Pastry / Pastelería Pâtisserie (60 x 40 cm)	52,5 x 70 x 90	8,5	1
P80780	GN 1/1 Doble	81 x 63,5 x 90	7,5	1

P8074 Trolley cutlery dispenser GN 1/3
Carro portacubiertos GN 1/3 y porta bandejas
Chariot porte-ramasse couverts GN 1/3



GN containers not included.
No incluye cubetas GN.
Bacs GN non inclus.

Available also on polyamide castors. Please ask for price.
Disponible también con ruedas poliamida. Consultar precio.
Disponible aussi avec roulettes polyamide. Consulter prix.

REF	1
P80740	1

Special trolleys 10.4

Carros especiales
Chariots spéciaux



P8075 Dishwasher rack trolley
P8076 Carro para cestas Vajillas
P8077 Chariot casiers à vaisselle



REF	Nr. of Levels Nº Guías Num. Niveaux	Size of rails Medida guías Dimensions glissières cm	W x D x H cm	1
P80750	5	50 x 50	64 x 63,3 x 116	1
P80760	9	50 x 50	64 x 63,3 x 171	1
P80770	9	50 x 50 (double / doble)	118,5 x 63,3 x 171	1

P8057 Trolley for heavy loads
Carro para cargas pesadas
Chariot à charges lourdes

Maximum load: 350 kg
Carga máxima: 350 kg
Charge maximale: 350 kg



REF	1
P80570	1

P8058 St/steel trolley for dishwasher racks
P8059 Carro inox para cestas
Chariot inox pour casiers à vaisselle



REF	H cm	without handle / sin asa / sans anse	1
P80590	16,5	without handle / sin asa / sans anse	1
P80580	106,5	with handle / con asa / avec anse	1

10.4 Special trolleys

Carros especiales
Chariots spéciaux



P5015 Plastic trolley for dishwasher racks
Carro de plástico para cestas
Chariot pour casiers à vaisselle

Without handle
Sin asa
Sans anse

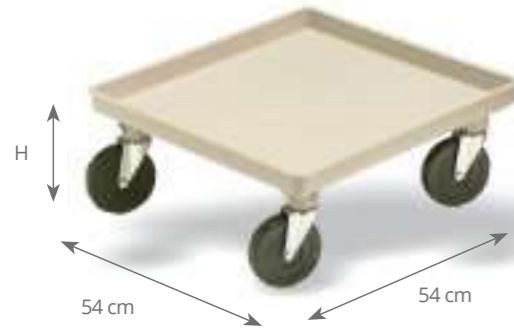

REF	H cm	
P5015	23	1

P5017 Plastic trolley with handle for dishwasher racks
Carro de plástico con asa para cestas
Chariot avec anse pour casiers à vaisselle

With handle
Con asa
Avec anse



REF	H cm	
P5017	98	1

1697 Plastic trolley for dishwasher racks
Carro de plástico para cestas
Chariot pour casiers à vaisselle

Without handle
Sin asa
Sans anse



REF	Ø cm	H cm	
1697	1,4	8,7	1

52291 Dishwasher rack insert or cover
Tapa o inserto para cestas
Couvercle or inserto pour casiers à vaisselle



REF		
52291		1

Special trolleys 10.4

Carros especiales
Chariots spéciaux



ADC-4 Adjustable dish caddy
Carro ajustable para platos
Chariot modulable pour assiettes



Delivered with 4 posts plus 1 protection cover.
Se sirve con 4 columnas separadoras más una funda protectora.
Livré avec 4 colonnes de séparation et 1 housse de protection.

Unique and easy adjustment from the top.
Ajuste único y fácil por la parte superior.
Reglage unique et facile de la partie supérieure.

COMBINATIONS
COMBINACIONES
COMBINATIONS
Size plates
Tamaño platos
Taille assiettes

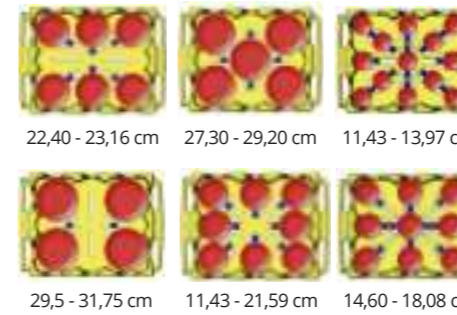

REF		
ADC-4		1

ADP Post for dish trolley
Columna separadora carro platos
Colonne séparation chariot assiettes



Compatible ref. ADC-4
Compatible ref. SAC-SQ5-06

REF		
ADP		1

SAC-SQ5-06 Adjustable caddy for square & round dishes
Carro ajustable para platos cuadrados y redondos
Chariot modulable pour assiettes carrées et rondes



Unique, stackable design.
Diseño exclusivo apilable.
Design exclusif empilable.

Delivered with 5 posts, one of them in cross shape plus 1 protection cover.
Se sirve con 5 columnas separadoras una de ellas en forma de cruz más una funda protectora.

Livré avec 5 colonnes de séparation une desquelles en forme de croix plus 1 housse de protection.



REF		
SAC-SQ5-06		1

SAVC Vinyl cover for dish trolley
Funda protectora de vinilo para carro platos
Housse protection en vinyle pour chariot assiettes



Cover for item SAVC. Funda para ref. ADC-4
Housse pour réf. SAC-SQ5-06

REF		
SAVC		1

11 Shelving

Estanterías
Rayonnages



11.1 COMPLETE AND ANGULAR SHELVING 267

ESTANTERÍAS COMPLETAS Y ANGULARES
RAYONNAGES COMPLETS ET ANGULAIRES

11.2 SHELVING WITH WHEELS 274

ESTANTERÍAS CON RUEDAS
RAYONNAGES AVEC ROUES

11.3 BENCH 274

BANCADAS
BANCS

11.4 PARTS 275

COMPONENTES
COMPOSANTS

11.5 BREAKDOWN OF SHELVING SETS 278

DESGLOSE CONJUNTOS DE ESTANTERÍAS
DÉCOMPOSITION KITS RAYONNAGES

Modular shelving

Estanterías modulares
Rayonnages modulables



-30 °C
+75 °C

Easy and quick assembly
Facilidad y rapidez de montaje
Montage facile et rapide



ANTICORROSIVE - Manufactured with special anodised aluminium

ANTICORROSIÓN - Fabricadas con estructura de aluminio anodizado

ANTI-CORROSION - Fabriqué avec une structure fabriquée en aluminium anodisé

Robustness and resistance

Robustez y resistencia
Robustesse et résistance

150 KG



420 KG



Compatibility
Compatible
Compatibilité
GN 1/1 & 2/3



Rack shelves

Parrillas
Clayettes

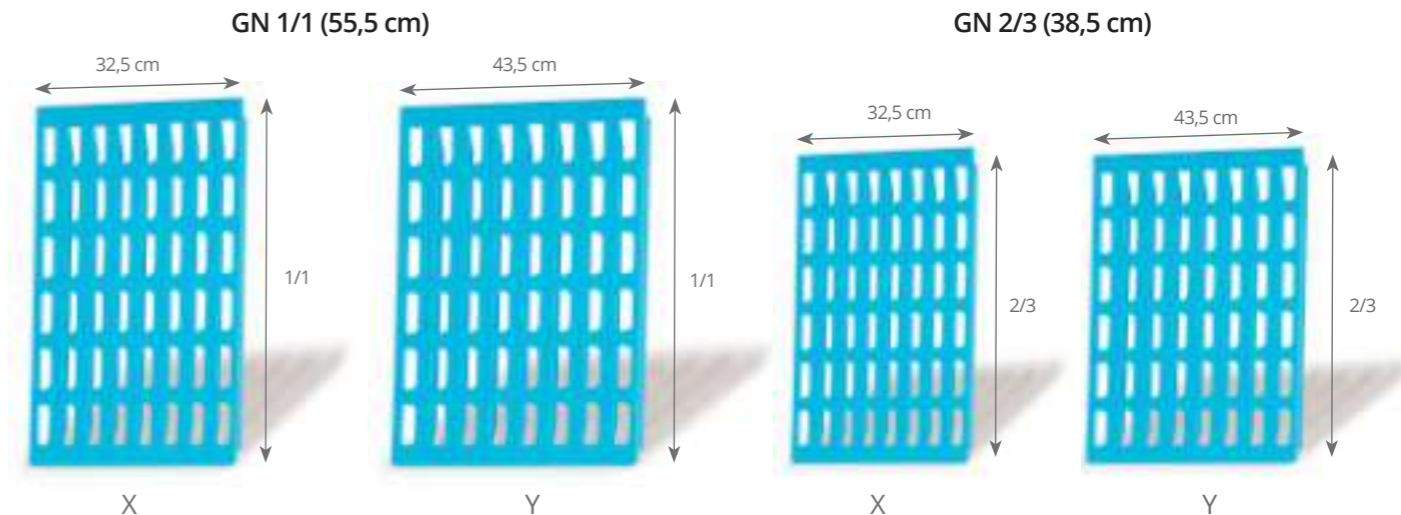

Dishwasher safe
Apto para lavavajillas
Apte pour lave-vaisselle

Combining rack shelves among the same group (X/Y) allows to personalize the lengths of each shelf. (Refer to next page for proposed combinations)

Combinando parrillas de la misma profundidad (X/Y) permite personalizar las longitudes de las estanterías a cada una de las necesidades. (Ver en página siguiente combinaciones propuestas)

En combinant des clayettes de la même profondeur (X/Y) permet de personnaliser les longueurs des rayonnages à tout besoin. (Voir page suivante pour des combinaisons proposées)

Support for crossbars

Pieza soporte travesaños
Support pour longerons



Special fixing system support for crossbars which offers the highest security, reliability and robustness.

Sistema especial de fijación de soporte para travesaños que ofrece la máxima seguridad, fiabilidad y robustez.

Système spécial de fixation des supports pour longerons qui offre la sécurité, fiabilité et robustesse maximale.

Adjustable feet

Pies regulables
Pieds réglables

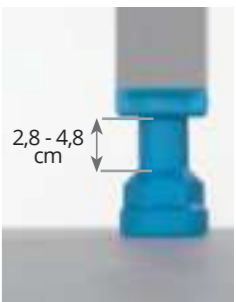

Levelling feet with hidden thread, for gradient floors. It is also possible to adapt Ø 12,5 cm wheels.

Pies regulables con rosca oculta para suelos con desniveles. Con la posibilidad de adaptar ruedas de Ø 12,5 cm.

Pieds réglables avec filetage caché pour sols irréguliers. Il est aussi possible d'y adapter des roues de Ø 12,5 cm.



Modular shelving

Estanterías modulares
Rayonnages modulables

Standard heights of levels

Alturas estándar de los niveles
Hauteur standard des niveaux

Higher than 200 cm please ask

Más de 200 cm altura consultar

Hauteur supérieure à 200 cm veuillez nous consulter

Height 175 cm / 3 levels
Altura 175 cm / 3 niveles
Hauteur 175 cm / 3 niveaux

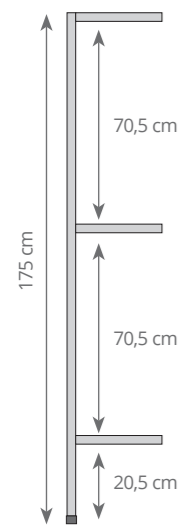

Height 175 cm / 4 levels
Altura 175 cm / 4 niveles
Hauteur 175 cm / 4 niveaux

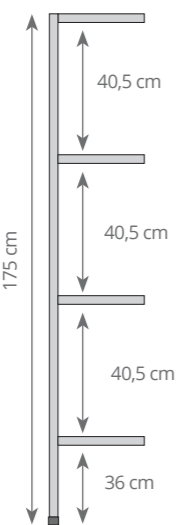

Height 130 cm / 3 levels
Altura 130 cm / 3 niveles
Hauteur 130 cm / 3 niveaux

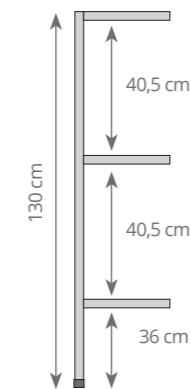

Height 175 cm / 5 levels
Altura 175 cm / 5 niveles
Hauteur 175 cm / 5 niveaux

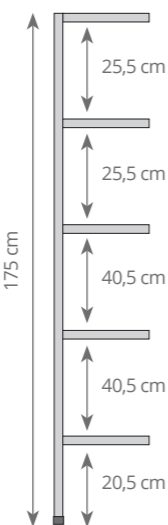

Height 205 cm / 4 levels
Altura 205 cm / 4 niveles
Hauteur 205 cm / 4 niveaux

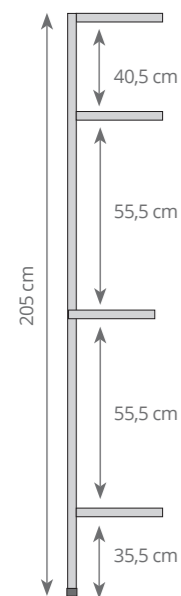

Height 205 cm / 5 levels
Altura 205 cm / 5 niveles
Hauteur 205 cm / 5 niveaux

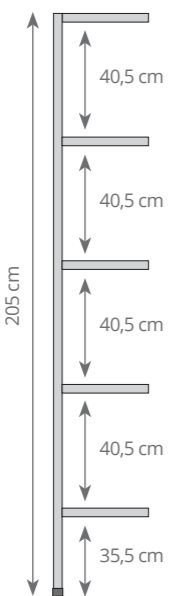

Height 205 cm / 6 levels
Altura 205 cm / 6 niveles
Hauteur 205 cm / 6 niveaux

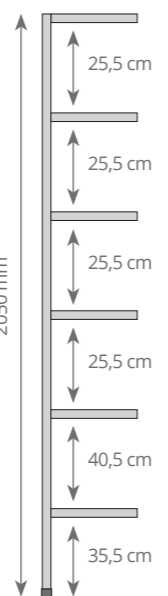

Combinations

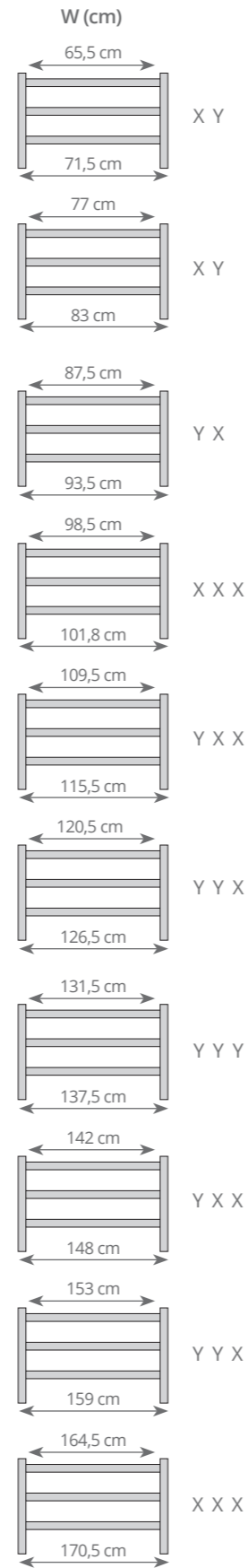

Complete and angular shelving

Estanterías completas y angulares
Rayonnages complets et angulaires



11.1 Full shelf

Estantería completa
Rayonnage complet

3 Levels
Niveles
Niveaux

Complete kits
Kits completos
Kits complets

Diferent combinations
Distintas combinaciones
Differentes combinaisons

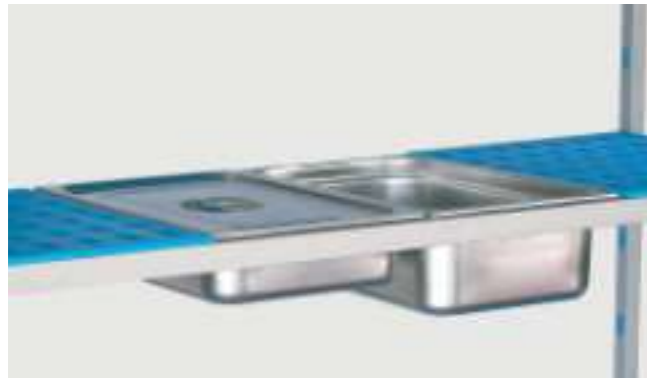

Compatible with 2/3 containers
Compatible con cubetas 2/3
Compatible avec bacs 2/3

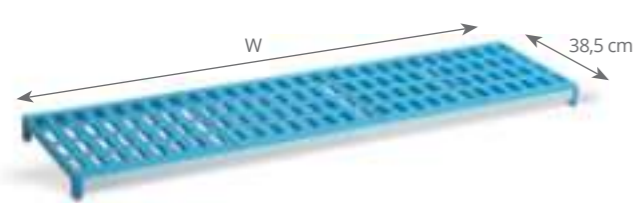

Compatible with 1/1 containers
Compatible con cubetas 1/1
Compatible avec bacs 1/1

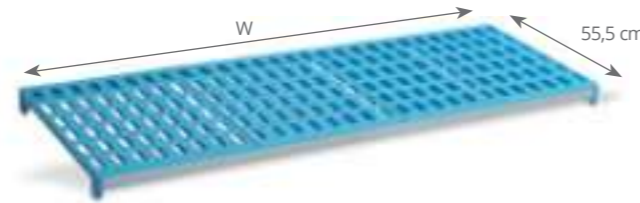

REF	W cm	REF	W cm
P7000	71,5	P7024	338,0
P7001	83,0	P7025	351,3
P7002	93,5	P7026	362,1
P7003	104,5	P7027	372,9
P7004	115,5	P7028	384,1
P7005	126,5	P7029	395,3
P7006	137,5	P7030	406,5
P7007	148,0	P7031	417,0
P7008	159,0	P7032	427,5
P7009	170,5	P7033	438,0
P7010	184,0	P7034	449,0
P7011	195,0	P7035	460,0
P7012	206,0	P7036	471,0
P7013	217,0	P7037	482,5
P7014	228,0	P7038	494,0
P7015	238,8	P7039	505,5
P7016	249,6	P7040	518,6
P7017	260,8	P7041	529,8
P7018	272,0	P7042	541,0
P7019	282,5	P7043	551,5
P7020	293,0	P7044	562,0
P7021	304,0	P7045	572,5
P7022	315,0	P7046	583,0
P7023	326,5		

REF	W cm	REF	W cm
P7141	71,5	P7165	338,0
P7142	83,0	P7166	351,3
P7143	93,5	P7167	362,1
P7144	104,5	P7168	372,9
P7145	115,5	P7169	384,1
P7146	126,3	P7170	395,3
P7147	137,5	P7171	406,5
P7148	148,0	P7172	417,0
P7149	159,0	P7173	427,5
P7150	170,5	P7174	438,0
P7151	184,0	P7175	449,0
P7152	195,0	P7176	460,0
P7153	206,0	P7177	471,0
P7154	217,0	P7178	482,5
P7155	228,0	P7179	494,0
P7156	238,8	P7180	505,5
P7157	249,6	P7181	518,6
P7158	260,8	P7182	529,8
P7159	272,0	P7183	541,0
P7160	282,5	P7184	551,5
P7161	293,0	P7185	562,0
P7162	304,0	P7186	572,5
P7163	315,0	P7187	583,0
P7164	326,5		

IDEA! * For others heights, see the table (p. 278 - 281)
* Para otras alturas, consultar el desglose (p. 278 - 281)
* Pour autres hauteurs, consulter le tableau de décomposition (p 278 - 281)

Shelving for angle 11.1

Estantería angular
Rayonnage angulaire

3 Levels
Niveles
Niveaux

Shelvings for angle
Estanterías angulares
Rayonnages angulaires

Diferent combinations
Distintas combinaciones
Differentes combinaisons

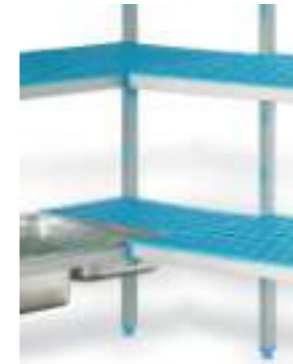

Included / Includo / Compris :
Hooks to form angles
Ganchos para formar ángulos
Crochets pour faire les angles

Compatible with 2/3 containers
Compatible con cubetas 2/3
Compatible avec bacs 2/3

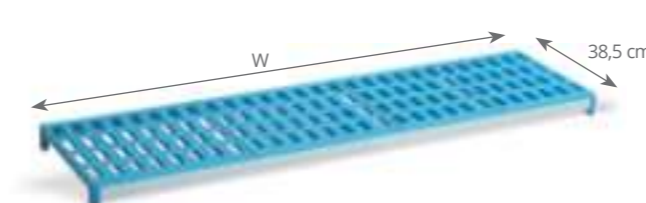

REF	W cm	REF	W cm
P7282	68,5	P7306	335,0
P7283	80,0	P7307	348,3
P7284	90,5	P7308	359,1
P7285	101,5	P7309	369,9
P7286	112,5	P7310	381,1
P7287	123,3	P7311	392,3
P7288	134,5	P7312	403,5
P7289	145,0	P7313	414,0
P7290	156,0	P7314	424,5
P7291	167,5	P7315	435,0
P7292	181,0	P7316	446,0
P7293	192,0	P7317	457,0
P7294	203,0	P7318	468,0
P7295	214,0	P7319	479,5
P7296	225,0	P7320	491,0
P7297	235,8	P7321	502,5
P7298	246,6	P7322	515,6
P7299	257,8	P7323	526,8
P7300	269,0	P7324	538,0
P7301	279,5	P7325	548,5
P7302	290,0	P7326	559,0
P7303	301,0	P7327	569,5
P7304	312,0	P7328	580,0
P7305	323,5		

IDEA! * For others heights, see the table (p. 278 - 281)
* Para otras alturas, consultar el desglose (p. 278 - 281)
* Pour autres hauteurs, consulter le tableau de décomposition (p 278 - 281)

11.1 Full shelf

Estantería completa
Rayonnage complet

4 Levels
Niveles
Niveaux

Complete kits
Kits completos
Kits complets

Diferent combinations
Distintas combinaciones
Differentes combinaisons

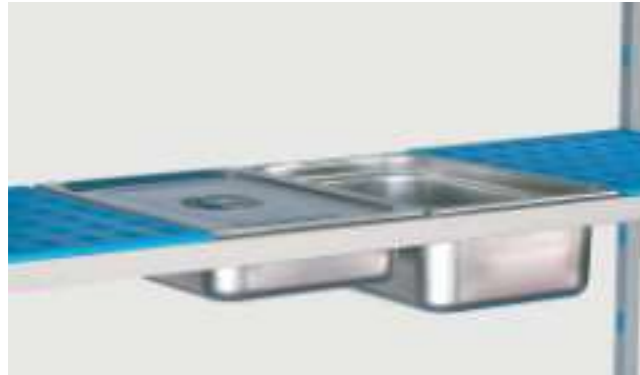

Compatible with 2/3 containers
Compatible con cubetas 2/3
Compatible avec bacs 2/3



Compatible with 1/1 containers
Compatible con cubetas 1/1
Compatible avec bacs 1/1



REF	W cm	REF	W cm
P7047	71,5	P7071	338,0
P7048	83,0	P7072	351,3
P7049	93,5	P7073	362,1
P7050	104,5	P7074	372,9
P7051	115,5	P7075	384,1
P7052	126,3	P7076	395,3
P7053	137,5	P7077	406,5
P7054	148,0	P7078	417,0
P7055	159,0	P7079	427,5
P7056	170,5	P7080	438,0
P7057	184,0	P7081	449,0
P7058	195,0	P7082	460,0
P7059	206,0	P7083	471,0
P7060	217,0	P7084	482,5
P7061	228,0	P7085	494,0
P7062	238,8	P7086	505,5
P7063	249,6	P7087	518,6
P7064	260,8	P7088	529,8
P7065	272,0	P7089	541,0
P7066	282,5	P7090	551,5
P7067	293,0	P7091	562,0
P7068	304,0	P7092	572,5
P7069	315,0	P7093	583,0
P7070	326,5		

REF	W cm	REF	W cm
P7188	71,5	P7212	338,0
P7189	83,0	P7213	351,3
P7190	93,5	P7214	362,1
P7191	104,5	P7215	372,9
P7192	115,5	P7216	384,1
P7193	126,3	P7217	395,3
P7194	137,5	P7218	406,5
P7195	148,0	P7219	417,0
P7196	159,0	P7220	427,5
P7197	170,5	P7221	438,0
P7198	184,0	P7222	449,0
P7199	195,0	P7223	460,0
P7200	206,0	P7224	471,0
P7201	217,0	P7225	482,5
P7202	228,0	P7226	494,0
P7203	238,8	P7227	505,5
P7204	249,6	P7228	518,6
P7205	260,8	P7229	529,8
P7206	272,0	P7230	541,0
P7207	282,5	P7231	551,5
P7208	293,0	P7232	562,0
P7209	304,0	P7233	572,5
P7210	315,0	P7234	583,0
P7211	326,5		

IDEA! * For others heights, see the table (p. 278 - 281)
* Para otras alturas, consultar el desglose (p. 278 - 281)
* Pour autres hauteurs, consulter le tableau de décomposition (p. 278 - 281)

Shelving for angle 11.1

Estantería angular
Rayonnage angulaire

4 Levels
Niveles
Niveaux

Shelvings for angle
Estanterías angulares
Rayonnages angulaires

Diferent combinations
Distintas combinaciones
Differentes combinaisons

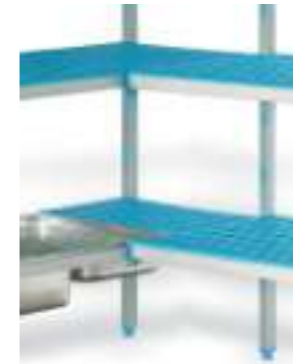

Included / Includo / Compris :
Hooks to form angles
Ganchos para formar ángulos
Crochets pour faire les angles

Compatible with 2/3 containers
Compatible con cubetas 2/3
Compatible avec bacs 2/3

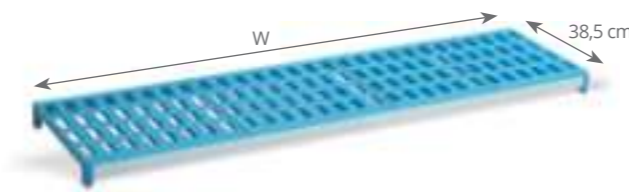

Compatible with 1/1 containers
Compatible con cubetas 1/1
Compatible avec bacs 1/1

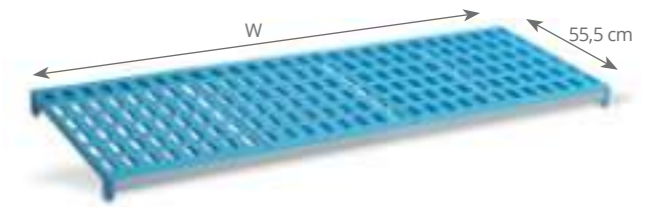

REF	W cm	REF	W cm
P7329	68,5	P7353	335,0
P7330	80,0	P7354	348,3
P7331	90,5	P7355	359,1
P7332	101,5	P7356	369,9
P7333	112,5	P7357	381,1
P7334	123,3	P7358	392,3
P7335	134,5	P7359	403,5
P7336	145,0	P7360	414,0
P7337	156,0	P7361	424,5
P7338	167,5	P7362	435,0
P7339	181,0	P7363	446,0
P7340	192,0	P7364	457,0
P7341	203,0	P7365	468,0
P7342	214,0	P7366	479,5
P7343	225,0	P7367	491,0
P7344	235,8	P7368	502,5
P7345	246,6	P7369	515,6
P7346	257,8	P7370	526,8
P7347	269,0	P7371	538,0
P7348	279,5	P7372	548,5
P7349	290,0	P7373	559,0
P7350	301,0	P7374	569,5
P7351	312,0	P7375	580,0
P7352	323,5		

REF	W cm	REF	W cm
P7470	68,5	P7494	335,0
P7471	80,0	P7495	348,3
P7472	90,5	P7496	359,1
P7473	101,5	P7497	369,9
P7474	112,5	P7498	381,1
P7475	123,3	P7499	392,3
P7476	134,5	P7500	403,5
P7477	145,0	P7501	414,0
P7478	156,0	P7502	424,5
P7479	167,5	P7503	435,0
P7480	181,0	P7504	446,0
P7481	192,0	P7505	457,0
P7482	203,0	P7506	468,0
P7483	214,0	P7507	479,5
P7484	225,0	P7508	491,0
P7485	235,8	P7509	502,5
P7486	246,6	P7510	515,6
P7487	257,8	P7511	526,8
P7488	269,0	P7512	538,0
P7489	279,5	P7513	548,5
P7490	290,0	P7514	559,0
P7491	301,0	P7515	569,5
P7492	312,0	P7516	580,0
P7493	323,5		

IDEA! * For others heights, see the table (p. 278 - 281)
* Para otras alturas, consultar el desglose (p. 278 - 281)
* Pour autres hauteurs, consulter le tableau de décomposition (p. 278 - 281)

11.1 Full shelf

Estantería completa
Rayonnage complet

5 Levels
Niveles
Niveaux

Complete kits
Kits completos
Kits complets

Diferent combinations
Distintas combinaciones
Diferentes combinaisons

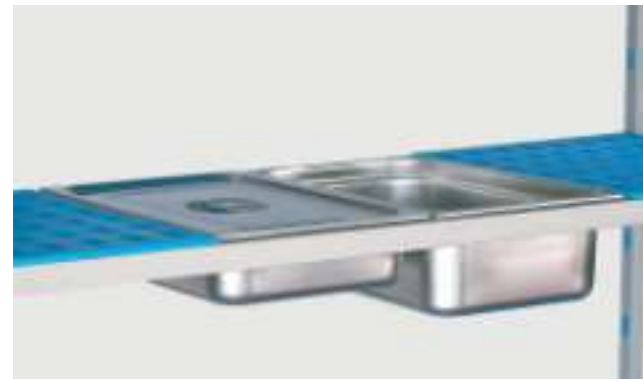

Compatible with 2/3 containers
Compatible con cubetas 2/3
Compatible avec bacs 2/3

Compatible with 1/1 containers
Compatible con cubetas 1/1
Compatible avec bacs 1/1

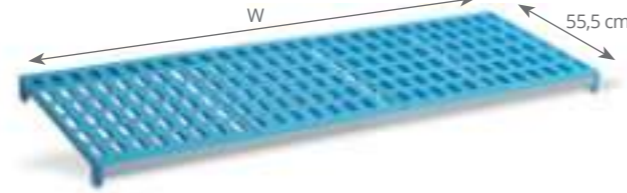
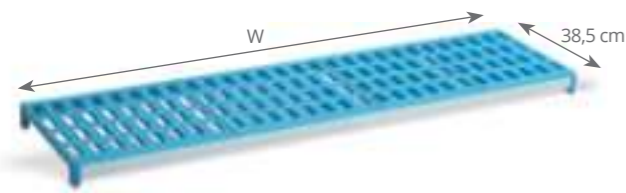

REF	W cm	REF	W cm
P7094	71,5	P7118	338,0
P7095	83,0	P7119	351,3
P7096	93,5	P7120	362,1
P7097	104,5	P7121	372,9
P7098	115,5	P7122	384,1
P7099	126,3	P7123	395,3
P7100	137,5	P7124	406,5
P7101	148,0	P7125	417,0
P7102	159,0	P7126	427,5
P7103	170,5	P7127	438,0
P7104	184,0	P7128	449,0
P7105	195,0	P7129	460,0
P7106	206,0	P7130	471,0
P7107	217,0	P7131	482,5
P7108	228,0	P7132	494,0
P7109	238,8	P7133	505,5
P7110	249,6	P7134	518,6
P7111	260,8	P7135	529,8
P7112	272,0	P7136	541,0
P7113	282,5	P7137	551,5
P7114	293,0	P7138	562,0
P7115	304,0	P7139	572,5
P7116	315,0	P7140	583,0
P7117	326,5		

REF	W cm	REF	W cm
P7235	71,5	P7259	338,0
P7236	83,0	P7260	351,3
P7237	93,5	P7261	362,1
P7238	104,5	P7262	372,9
P7239	115,5	P7263	384,1
P7240	126,3	P7264	395,3
P7241	137,5	P7265	406,5
P7242	148,0	P7266	417,0
P7243	159,0	P7267	427,5
P7244	170,5	P7268	438,0
P7245	184,0	P7269	449,0
P7246	195,0	P7270	460,0
P7247	206,0	P7271	471,0
P7248	217,0	P7272	482,5
P7249	228,0	P7273	494,0
P7250	238,8	P7274	505,5
P7251	249,6	P7275	518,6
P7252	260,8	P7276	529,8
P7253	272,0	P7277	541,0
P7254	282,5	P7278	551,5
P7255	293,0	P7279	562,0
P7256	304,0	P7280	572,5
P7257	315,0	P7281	583,0
P7258	326,5		

IDEA! * For others heights, see the table (p. 278 - 281)
* Para otras alturas, consultar el desglose (p. 278 - 281)
* Pour autres hauteurs, consulter le tableau de décomposition (p. 278 - 281)

Shelving for angle 11.1

Estantería angular
Rayonnage angulaire

5 Levels
Niveles
Niveaux

Shelvings for angle
Estanterías angulares
Rayonnages angulaires

Diferent combinations
Distintas combinaciones
Diferentes combinaisons

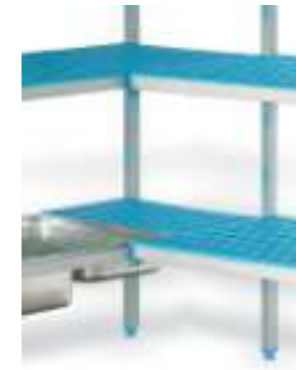

Included / Includo / Compris:
Hooks to form angles
Ganchos para formar ángulos
Crochets pour faire les angles



Compatible with 2/3 containers
Compatible con cubetas 2/3
Compatible avec bacs 2/3

Compatible with 1/1 containers
Compatible con cubetas 1/1
Compatible avec bacs 1/1

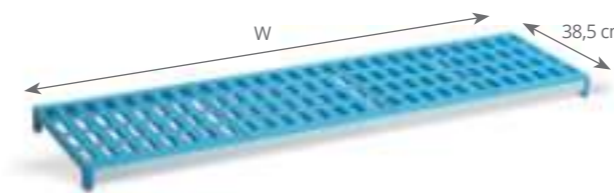

REF	W cm	REF	W cm
P7376	68,5	P7400	335,0
P7377	80,0	P7401	348,3
P7378	90,5	P7402	359,1
P7379	101,5	P7403	369,9
P7380	112,5	P7404	381,1
P7381	123,3	P7405	392,3
P7382	134,5	P7406	403,5
P7383	145,0	P7407	414,0
P7384	156,0	P7408	424,5
P7385	167,5	P7409	435,0
P7386	181,0	P7410	446,0
P7387	192,0	P7411	457,0
P7388	203,0	P7412	468,0
P7389	214,0	P7413	479,5
P7390	225,0	P7414	491,0
P7391	235,8	P7415	502,5
P7392	246,6	P7416	515,6
P7393	257,8	P7417	526,8
P7394	269,0	P7418	538,0
P7395	279,5	P7419	548,5
P7396	290,0	P7420	559,0
P7397	301,0	P7421	569,5
P7398	312,0	P7422	580,0
P7399	323,5		

REF	W cm	REF	W cm
P7517	68,5	P7541	335,0
P7518	80,0	P7542	348,3
P7519	90,5	P7543	359,1
P7520	101,5	P7544	369,9
P7521	112,5	P7545	381,1
P7522	123,3	P7546	392,3
P7523	134,5	P7547	403,5
P7524	145,0	P7548	414,0
P7525	156,0	P7549	424,5
P7526	167,5	P7550	435,0
P7527	181,0	P7551	446,0
P7528	192,0	P7552	457,0
P7529	203,0	P7553	468,0
P7530	214,0	P7554	479,5
P7531	225,0	P7555	491,0
P7532	235,8	P7556	502,5
P7533	246,6	P7557	515,6
P7534	257,8	P7558	526,8
P7535	269,0	P7559	538,0
P7536	279,5	P7560	548,5
P7537	290,0	P7561	559,0
P7538	301,0	P7562	569,5
P7539	312,0	P7563	580,0
P7540	323,5		

IDEA! * For others heights, see the table (p. 278 - 281)
* Para otras alturas, consultar el desglose (p. 278 - 281)
* Pour autres hauteurs, consulter le tableau de décomposition (p. 278 - 281)

112 Shelving with castors

Estanterías con ruedas
Rayonnages avec roues

Complete kits with wheels
Conjuntos completos con ruedas
Kits complets avec roues

Maximum weight per level 150 kg
Maximum weight per shelving unit 400 kg

Peso máximo por nivel 150 kg
Peso máximo por estantería 400 kg
Poids maximum par niveau 150 kg
Poids maximum par rayonnage 400 kg



REF	W x D x H cm	Type / tipo	Levels Niveles Niveaux	
P7145R	114,5 x 55,5 x 188	GN 1/1	3	1
P7004R	114,5 x 38,5 x 188	GN 2/3	3	1
P7146R	126,5 x 55,5 x 188	GN 1/1	3	1
P7005R	126,5 x 38,5 x 188	GN 2/3	3	1
P7147R	137,5 x 55,5 x 188	GN 1/1	3	1
P7006R	137,5 x 38,5 x 188	GN 2/3	3	1

113 Bench

Bancadas
Bancs

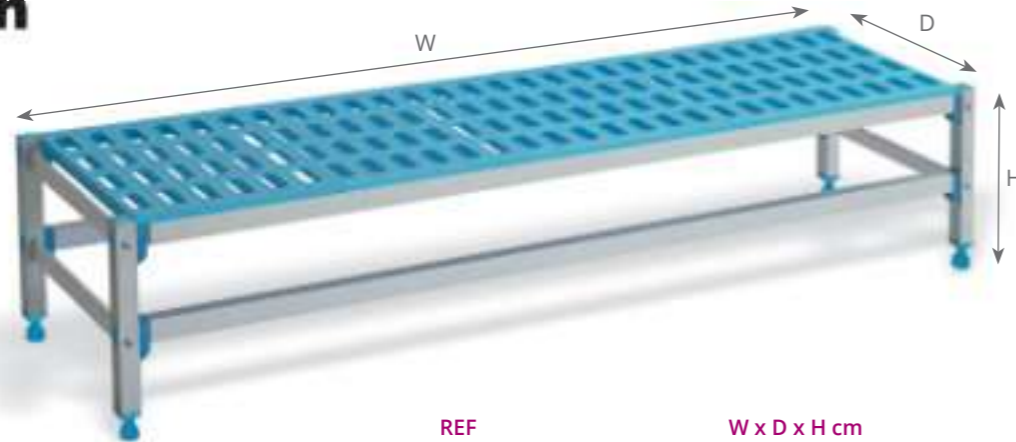

Designed to be used in places where it is forbidden to put boxes directly on the floor. Maximum load charge 175 Kg per bench, distributed weight throughout the bench. Leveling feet for gradient floors.

Diseñadas para su uso en lugares donde se prohíbe depositar cajas directamente en el suelo. Capacidad de carga de hasta 175 Kg por bancada, repartidos a lo largo de la bancada. Pie regulable para suelos desnivelados.

Conçus pour être utilisés quand il est interdit de poser les boîtes directement par terre. Charge maximale 175 Kg, distribués tout au long du banc. Pieds réglables pour sols irréguliers.

REF	W x D x H cm	
P7603	71,5 x 55,5 x 28	1
P7604	83,0 x 55,5 x 28	1
P7605	93,5 x 55,5 x 28	1
P7606	104,5 x 55,5 x 28	1
P7607	115,5 x 55,5 x 28	1
P7608	126,5 x 55,5 x 28	1
P7609	137,5 x 55,5 x 28	1
P7610	148,0 x 55,5 x 28	1
P7611	71,5 x 38,5 x 28	1
P7612	83,0 x 38,5 x 28	1
P7613	93,5 x 38,5 x 28	1
P7614	104,5 x 38,5 x 28	1
P7615	115,5 x 38,5 x 28	1
P7616	126,5 x 38,5 x 28	1
P7617	137,5 x 38,5 x 28	1
P7618	148,0 x 38,5 x 28	1

Parts 114

Componentes
Composants

Shelf support fixing
Soporte fijación estantería
Support fixation rayonnage



Two pieces kit
Conjunto de 2 soportes
Kit deux pièces

REF	
P76430	1



Crossbars
Travesaños
Longerons



REF	W cm	
P7632	65,5	1
P7633	77,0	1
P7634	87,5	1
P7635	98,5	1
P7636	109,5	1
P7637	120,5	1
P7638	131,5	1
P7639	142,0	1
P7640	153,0	1
P7641	164,5	1

Rack-shelves
Parrillas
Clayettes

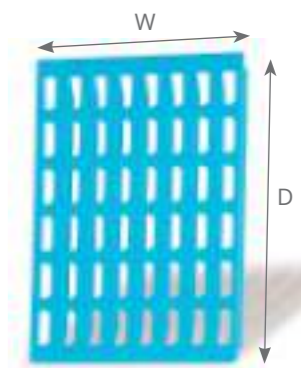

REF	Type / Tipo	W x D cm	GN For / Para / Pour	
P7628	Y	55,5 x 43,5	1/1	1
P7629	X	55,5 x 32,5	1/1	1
P7630	Y	38,5 x 43,5	2/3	1
P7631	X	38,5 x 32,5	2/3	1

Hooks to form angles
Ganchos para formar ángulos
Crochets pour faire les angles



REF	
P7642	1

Support for crossbars
Pieza soporte para travesaños
Support pour longerons



REF	
P7643	1

114 Parts

Componentes
Composants

Lateral supports Soportes laterales Suports latéraux



2 Available depths:
55,5 cm, 1/1 gastronorm
38,5 cm, 2/3 gastronorm

2 Fondos disponibles :
55,5 cm, gastronorm 1/1
38,5 cm, gastronorm 2/3

2 profondeurs disponibles:
55,5 cm, gastronorm 1/1
38,5 cm, gastronorm 2/3

REF	MOD	D x H cm	Levels Niveles Niveaux	📦
P7585	S1	55,5 x 175	3	1
P7586	S2	55,5 x 175	4	1
P7587	S3	55,5 x 175	5	1
P7646	S0	55,5 x 200	4	1
P7588	S4	55,5 x 200	5	1
P7589	S5	55,5 x 200	6	1
P7590	S6	55,5 x 130	3	1
P7591	S7	38,5 x 175	3	1
P7592	S8	38,5 x 175	4	1
P7593	S9	38,5 x 175	5	1
P7647	S13	38,5 x 200	4	1
P7594	S10	38,5 x 200	5	1
P7595	S11	38,5 x 200	6	1
P7596	S12	38,5 x 130	3	1

Lateral support with wheels Soportes laterales con ruedas Suports latéraux avec roues



To assembly mobile shelving with wheels.
Para montar estanterías móviles con ruedas.
Pour monter rayonnages mobiles avec roues.

* Height including wheel
* Altura con rueda incluida
* Hauteur avec la roue incluse

Wheels Ø 12,5 cm, two of them with brake.
Ruedas de Ø 12,5 cm, dos de ellas con freno.
Roues de Ø 12,5 cm, dont deux avec frein.

We do not recommend crossbars longer than 140 cm.
No se recomiendan longitudes de travesaños superiores a 140 cm.
Nous ne conseillons pas des longerons plus longs de 140 cm.

REF	D x H cm	Niveles Levels Niveaux	📦
P7597	55,5 x 188	3	1
P7598	55,5 x 188	4	1
P7599	55,5 x 188	5	1

Parts 114

Componentes
Composants

Shelves depth 38,5 cm Estantes fondo 38,5 cm Niveaux profondeur 38,5 cm

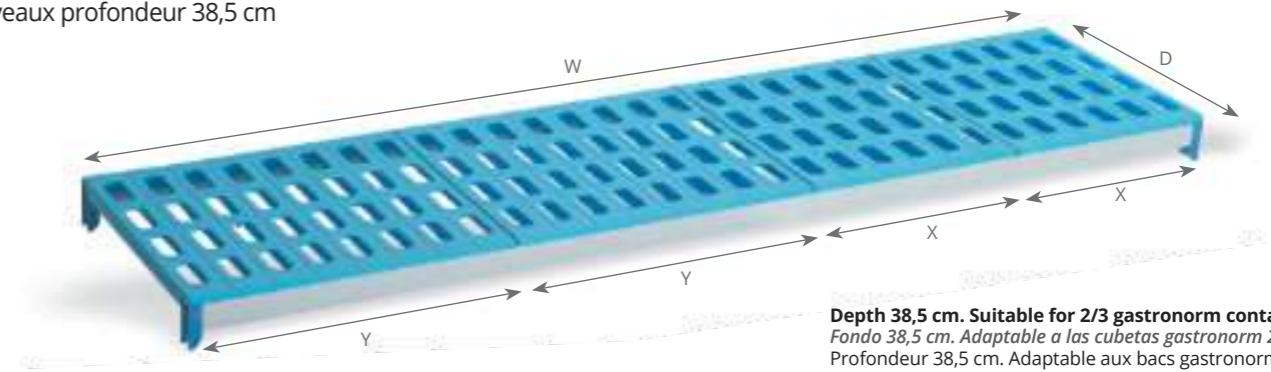

Depth 38,5 cm. Suitable for 2/3 gastronorm containers
Fondo 38,5 cm. Adaptable a las cubetas gastronorm 2/3
Profondeur 38,5 cm. Adaptable aux bacs gastronorm 2/3

X is a rack 32,5 cm width.
Y is a rack 43,5 cm width.

X significa una parrilla de ancho 32,5 cm.
Y significa una parrilla de ancho 43,5 cm.
X est une clayette de 32,5 cm de largeur.
Y est une clayette de 43,5 cm de largeur.

REF	MOD	Combinación Combinaison	W x D cm	📦
P7575	T61	X + X	65,5 x 38,5	1
P7576	T71	X + Y	77,0 x 38,5	1
P7577	T81	Y + Y	87,5 x 38,5	1
P7578	T91	X + X + X	98,5 x 38,5	1
P7579	T101	Y + X + X	109,5 x 38,5	1
P7580	T111	Y + Y + X	120,5 x 38,5	1
P7581	T131	Y + Y + Y	131,5 x 38,5	1
P7582	T141	Y + X + X + X	142,0 x 38,5	1
P7583	T151	Y + Y + X + X	153,0 x 38,5	1
P7584	T161	Y + Y + Y + X	164,5 x 38,5	1

Shelves depth 55,5 cm Estantes fondo 55,5 cm Niveaux profondeur 55,5 cm

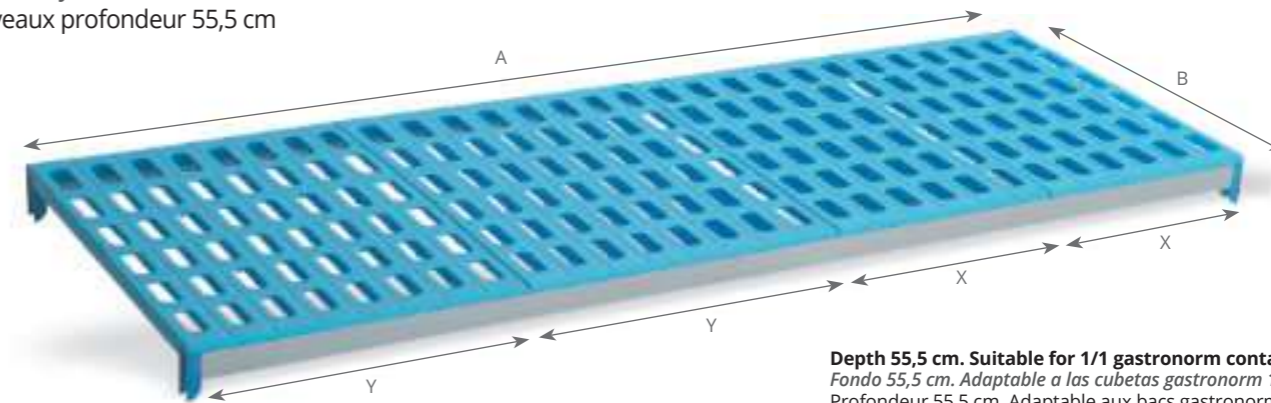

Depth 55,5 cm. Suitable for 1/1 gastronorm containers
Fondo 55,5 cm. Adaptable a las cubetas gastronorm 1/1
Profondeur 55,5 cm. Adaptable aux bacs gastronorm 1/1

X is a rack 32,5 cm width.
Y is a rack 43,5 cm width.

X significa una parrilla de ancho 32,5 cm.
Y significa una parrilla de ancho 43,5 cm.
X est une clayette de 32,5 cm de largeur.
Y est une clayette de 43,5 cm de largeur.

REF	MOD	Combinación Combinaison	W x D cm	📦
P7565	T6	X + X	65,5 x 55,5	1
P7566	T7	X + Y	77,0 x 55,5	1
P7567	T8	Y + Y	87,5 x 55,5	1
P7568	T9	X + X + X	98,5 x 55,5	1
P7569	T10	Y + X + X	109,5 x 55,5	1
P7570	T11	Y + Y + X	120,5 x 55,5	1
P7571	T13	Y + Y + Y	131,5 x 55,5	1
P7572	T14	Y + X + X + X	142,0 x 55,5	1
P7573	T15	Y + Y + X + X	153,0 x 55,5	1
P7574	T16	Y + Y + Y + X	164,5 x 55,5	1

11.5 Breakdown of shelving sets

Desglose conjuntos de estanterías
Décomposition kits rayonnages

DEPTH 38,5 cm. Suitable for 2/3 GASTRONORM

FONDO 38,5 cm. Adaptable a GASTRONORM 2/3

PROFONDEUR 38,5 cm. Adaptable aux GASTRONORME 2/3

REF. 3 levels 3 niveles 3 niveaux	Breakdown Desglose Décomposition	REF. 4 levels 4 niveles 4 niveaux	Breakdown Desglose Décomposition	REF. 5 levels 5 niveles 5 niveaux	Breakdown Desglose Décomposition
P7000	2 S7 + 3 T61	P7047	2 S8 + 4 T61	P7094	2 S9 + 5 T61
P7001	2 S7 + 3 T71	P7048	2 S8 + 4 T71	P7095	2 S9 + 5 T71
P7002	2 S7 + 3 T81	P7049	2 S8 + 4 T81	P7096	2 S9 + 5 T81
P7003	2 S7 + 3 T91	P7050	2 S8 + 4 T91	P7097	2 S9 + 5 T91
P7004	2 S7 + 3 T101	P7051	2 S8 + 4 T101	P7098	2 S9 + 5 T101
P7005	2 S7 + 3 T111	P7052	2 S8 + 4 T111	P7099	2 S9 + 5 T111
P7006	2 S7 + 3 T131	P7053	2 S8 + 4 T131	P7100	2 S9 + 5 T131
P7007	2 S7 + 3 T141	P7054	2 S8 + 4 T141	P7101	2 S9 + 5 T141
P7008	2 S7 + 3 T151	P7055	2 S8 + 4 T151	P7102	2 S9 + 5 T151
P7009	2 S7 + 3 T161	P7056	2 S8 + 4 T161	P7103	2 S9 + 5 T161
P7010	3 S7 + 6 T81	P7057	3 S8 + 8 T81	P7104	3 S9 + 10 T81
P7011	3 S7 + 3 T81 + 3 T91	P7058	3 S8 + 4 T81 + 4 T91	P7105	3 S9 + 5 T81 + 5 T91
P7012	3 S7 + 6 T91	P7059	3 S8 + 8 T91	P7106	3 S9 + 10 T91
P7013	3 S7 + 3 T91 + 3 T101	P7060	3 S8 + 4 T91 + 4 T101	P7107	3 S9 + 5 T91 + 5 T101
P7014	3 S7 + 6 T101	P7061	3 S8 + 8 T101	P7108	3 S9 + 10 T101
P7015	3 S7 + 3 T101 + 3 T111	P7062	3 S8 + 4 T101 + 4 T111	P7109	3 S9 + 5 T101 + 5 T111
P7016	3 S7 + 6 T111	P7063	3 S8 + 8 T111	P7110	3 S9 + 10 T111
P7017	3 S7 + 3 T111 + 3 T131	P7064	3 S8 + 4 T111 + 4 T131	P7111	3 S9 + 5 T111 + 5 T131
P7018	3 S7 + 6 T131	P7065	3 S8 + 8 T131	P7112	3 S9 + 10 T131
P7019	3 S7 + 3 T131 + 3 T141	P7066	3 S8 + 4 T131 + 4 T141	P7113	3 S9 + 5 T131 + 5 T141
P7020	3 S7 + 6 T141	P7067	3 S8 + 8 T141	P7114	3 S9 + 10 T141
P7021	3 S7 + 3 T141 + 3 T151	P7068	3 S8 + 4 T141 + 4 T151	P7115	3 S9 + 5 T141 + 5 T151
P7022	3 S7 + 6 T151	P7069	3 S8 + 8 T151	P7116	3 S9 + 10 T151
P7023	3 S7 + 3 T151 + 3 T161	P7070	3 S8 + 4 T151 + 4 T161	P7117	3 S9 + 5 T151 + 5 T161
P7024	3 S7 + 6 T161	P7071	3 S8 + 8 T161	P7118	3 S9 + 10 T161
P7025	4 S7 + 6 T101 + 3 T111	P7072	4 S8 + 8 T101 + 4 T111	P7119	4 S9 + 10 T101 + 5 T111
P7026	4 S7 + 3 T101 + 6 T111	P7073	4 S8 + 4 T101 + 8 T111	P7120	4 S9 + 5 T101 + 10 T111
P7027	4 S7 + 9 T111	P7074	4 S8 + 12 T111	P7121	4 S9 + 15 T111
P7028	4 S7 + 6 T111 + 3 T131	P7075	4 S8 + 8 T111 + 4 T131	P7122	4 S9 + 10 T111 + 5 T131
P7029	4 S7 + 3 T111 + 6 T131	P7076	4 S8 + 4 T111 + 8 T131	P7123	4 S9 + 5 T111 + 10 T131
P7030	4 S7 + 9 T131	P7077	4 S8 + 12 T131	P7124	4 S9 + 15 T131
P7031	4 S7 + 6 T131 + 3 T141	P7078	4 S8 + 8 T131 + 4 T141	P7125	4 S9 + 10 T131 + 5 T141
P7032	4 S7 + 3 T131 + 6 T141	P7079	4 S8 + 4 T131 + 8 T141	P7126	4 S9 + 5 T131 + 10 T141
P7033	4 S7 + 9 T141	P7080	4 S8 + 12 T141	P7127	4 S9 + 15 T141
P7034	4 S7 + 6 T141 + 3 T151	P7081	4 S8 + 8 T141 + 4 T151	P7128	4 S9 + 10 T141 + 5 T151
P7035	4 S7 + 3 T141 + 6 T151	P7082	4 S8 + 4 T141 + 8 T151	P7129	4 S9 + 5 T141 + 10 T151
P7036	4 S7 + 9 T151	P7083	4 S8 + 12 T151	P7130	4 S9 + 15 T151
P7037	4 S7 + 6 T151 + 3 T161	P7084	4 S8 + 8 T151 + 4 T161	P7131	4 S9 + 10 T151 + 5 T161
P7038	4 S7 + 3 T151 + 6 T161	P7085	4 S8 + 4 T151 + 8 T161	P7132	4 S9 + 5 T151 + 10 T161
P7039	4 S7 + 9 T161	P7086	4 S8 + 12 T161	P7133	4 S9 + 15 T161
P7040	5 S7 + 6 T111 + 6 T131	P7087	5 S8 + 8 T111 + 8 T131	P7134	5 S9 + 10 T111 + 10 T131
P7041	5 S7 + 3 T111 + 9 T131	P7088	5 S8 + 4 T111 + 12 T131	P7135	5 S9 + 5 T111 + 15 T131
P7042	5 S7 + 12 T131	P7089	5 S8 + 16 T131	P7136	5 S9 + 20 T131
P7043	5 S7 + 3 T141 + 9 T131	P7090	5 S8 + 4 T141 + 12 T131	P7137	5 S9 + 5 T141 + 15 T131
P7044	5 S7 + 6 T131 + 6 T141	P7091	5 S8 + 8 T131 + 8 T141	P7138	5 S9 + 10 T131 + 10 T141
P7045	5 S7 + 3 T131 + 9 T141	P7092	5 S8 + 4 T131 + 12 T141	P7139	5 S9 + 5 T131 + 15 T141
P7046	5 S7 + 12 T141	P7093	5 S8 + 16 T141	P7140	5 S9 + 20 T141

Breakdown of shelving sets 115

Desglose conjuntos de estanterías
Décomposition kits rayonnages

DEPTH 55,5 cm. Suitable for 1/1 GASTRONORM

FONDO 55,5 cm. Adaptable a GASTRONORM 1/1

PROFONDEUR 55,5 cm. Adaptable aux GASTRONORME 1/1

REF. 3 levels 3 niveles 3 niveaux	Breakdown Desglose Décomposition	REF. 4 levels 4 niveles 4 niveaux	Breakdown Desglose Décomposition	REF. 5 levels 5 niveles 5 niveaux	Breakdown Desglose Décomposition
P7141	2 S1 + 3 T6	P7188	2 S2 + 4 T6	P7235	2 S3 + 5 T6
P7142	2 S1 + 3 T7	P7189	2 S2 + 4 T7	P7236	2 S3 + 5 T7
P7143	2 S1 + 3 T8	P7190	2 S2 + 4 T8	P7237	2 S3 + 5 T8
P7144	2 S1 + 3 T9	P7191	2 S2 + 4 T9	P7238	2 S3 + 5 T9
P7145	2 S1 + 3 T10	P7192	2 S2 + 4 T10	P7239	2 S3 + 5 T10
P7146	2 S1 + 3 T11	P7193	2 S2 + 4 T11	P7240	2 S3 + 5 T11
P7147	2 S1 + 3 T13	P7194	2 S2 + 4 T13	P7241	2 S3 + 5 T13
P7148	2 S1 + 3 T14	P7195	2 S2 + 4 T14	P7242	2 S3 + 5 T14
P7149	2 S1 + 3 T15	P7196	2 S2 + 4 T15	P7243	2 S3 + 5 T15
P7150	2 S1 + 3 T16	P7197	2 S2 + 4 T16	P7244	2 S3 + 5 T16
P7151	3 S1 + 6 T8	P7198	3 S2 + 8 T8	P7245	3 S3 + 10 T8
P7152	3 S1 + 3 T8 + 3 T9	P7199	3 S2 + 4 T8 + 4 T9	P7246	3 S3 + 5 T8 + 5 T9
P7153	3 S1 + 6 T9	P7200	3 S2 + 8 T9	P7247	3 S3 + 10 T9
P7154	3 S1 + 3 T9 + 3 T10	P7201	3 S2 + 4 T9 + 4 T10	P7248	3 S3 + 5 T9 + 5 T10
P7155	3 S1 + 6 T10	P7202	3 S2 + 8 T10	P7249	3 S3 + 10 T10
P7156	3 S1 + 3 T10 + 3 T11	P7203	3 S2 + 4 T10 + 4 T11	P7250	3 S3 + 5 T10 + 5 T11
P7157	3 S1 + 6 T11	P7204	3 S2 + 8 T11	P7251	3 S3 + 10 T11
P7158	3 S1 + 3 T11 + 3 T13	P7205	3 S2 + 4 T11 + 4 T13	P7252	3 S3 + 5 T11 + 5 T13
P7159	3 S1 + 6 T13	P7206	3 S2 + 8 T13	P7253	3 S3 + 10 T13
P7160	3 S1 + 3 T13 + 3 T14	P7207	3 S2 + 4 T13 + 4 T14	P7254	3 S3 + 5 T13 + 5 T14
P7161	3 S1 + 6 T14	P7208	3 S2 + 8 T14	P7255	3 S3 + 10 T14
P7162	3 S1 + 3 T14 + 3 T15	P7209	3 S2 + 4 T14 + 4 T15	P7256	3 S3 + 5 T14 + 5 T15
P7163	3 S1 + 6 T15	P7210	3 S2 + 8 T15	P7257	3 S3 + 10 T15
P7164	3 S1 + 3 T15 + 3 T16	P7211	3 S2 + 4 T15 + 4 T16	P7258	3 S3 + 5 T15 + 5 T16
P7165	3 S1 + 6 T16	P7212	3 S2 + 8 T16	P7259	3 S3 + 10 T16
P7166	4 S1 + 6 T10 + 3 T11	P7213	4 S2 + 8 T10 + 4 T11	P7260	4 S3 + 10 T10 + 5 T11
P7167	4 S1 + 3 T10 + 6 T11	P7214	4 S2 + 4 T10 + 8 T11	P7261	4 S3 + 5 T10 + 10 T11
P7168	4 S1 + 9 T11	P7215	4 S2 + 12 T11	P7262	4 S3 + 15 T11
P7169	4 S1 + 6 T11 + 3 T13	P7216	4 S2 + 8 T11 + 4 T13	P7263	4 S3 + 10 T11 + 5 T13
P7170	4 S1 + 3 T11 + 6 T13	P7217	4 S2 + 4 T11 + 8 T13	P7264	4 S3 + 5 T11 + 10 T13
P7171	4 S1 + 9 T13	P7218	4 S2 + 12 T13	P7265	4 S3 + 15 T13
P7172	4 S1 + 6 T13 + 3 T14	P7219	4 S2 + 8 T13 + 4 T14	P7266	4 S3 + 10 T13 + 5 T14
P7173	4 S1 + 3 T13 + 6 T14	P7220	4 S2 + 4 T13 + 8 T14	P7267	4 S3 + 5 T13 + 10 T14
P7174	4 S1 + 9 T14	P7221	4 S2 + 12 T14	P7268	4 S3 + 15 T14
P7175	4 S1 + 6 T14 + 3 T15	P7222	4 S2 + 8 T14 + 4 T15	P7269	4 S3 + 10 T14 + 5 T15
P7176	4 S1 + 3 T14 + 6 T15	P7223	4 S2 + 4 T14 + 8 T15	P7270	4 S3 + 5 T14 + 10 T15
P7177	4 S1 + 9 T15	P7224	4 S2 + 12 T15	P7271	4 S3 + 15 T15
P7178	4 S1 + 6 T15 + 3 T16	P7225	4 S2 + 8 T15 + 4 T16	P7272	4 S3 + 10 T15 + 5 T16
P7179	4 S1 + 3 T15 + 6 T16	P7226	4 S2 + 4 T15 + 8 T16	P7273	4 S3 + 5 T15 + 10 T16
P7180	4 S1 + 9 T16	P7227	4 S2 + 12 T16	P7274	4 S3 + 15 T16
P7181	5 S1 + 6 T11 + 6 T13	P7228	5 S2 + 8 T11 + 8 T13	P7275	5 S3 + 10 T11 + 10 T13
P7182	5 S1 + 3 T11 + 9 T13	P7229	5 S2 + 4 T11 + 12 T13	P7276	5 S3 + 5 T11 + 15 T13
P7183	5 S1 + 12 T13	P7230	5 S2 + 16 T13	P7277	5 S3 + 20 T13
P7184	5 S1 + 3 T14 + 9 T13	P7231	5 S2 + 4 T14 + 12 T13	P7278	5 S3 + 5 T14 + 15 T13
P7185	5 S1 + 6 T13 + 6 T14	P7232	5 S2 + 8 T13 + 8 T14	P7279	5 S3 + 10 T13 + 10 T14
P7186	5 S1 + 3 T13 + 9 T14	P7233	5 S2 + 4 T13 + 12 T14	P7280	5 S3 + 5 T13 + 15 T14
P7187	5 S1 + 12 T14	P7234	5 S2 + 16 T14	P7281	5 S3 + 20 T14

11.5 Breakdown of shelving sets

Desglose conjuntos de estanterías
Décomposition kits rayonnages

DEPTH 38,5 cm. Suitable for 2/3 GASTRONORM

FONDO 38,5 cm. Adaptable a GASTRONORM 2/3

PROFONDEUR 38,5 cm. Adaptable aux GASTRONORME 2/3

REF. 3 levels 3 niveles 3 niveaux	Breakdown Desglose Décomposition	REF. 4 levels 4 niveles 4 niveaux	Breakdown Desglose Décomposition	REF. 5 levels 5 niveles 5 niveaux	Breakdown Desglose Décomposition
P7282	1 S7 + 3 T61	P7329	1 S8 + 4 T61	P7376	1 S9 + 5 T61
P7283	1 S7 + 3 T71	P7330	1 S8 + 4 T71	P7377	1 S9 + 5 T71
P7284	1 S7 + 3 T81	P7331	1 S8 + 4 T81	P7378	1 S9 + 5 T81
P7285	1 S7 + 3 T91	P7332	1 S8 + 4 T91	P7379	1 S9 + 5 T91
P7286	1 S7 + 3 T101	P7333	1 S8 + 4 T101	P7380	1 S9 + 5 T101
P7287	1 S7 + 3 T111	P7334	1 S8 + 4 T111	P7381	1 S9 + 5 T111
P7288	1 S7 + 3 T131	P7335	1 S8 + 4 T131	P7382	1 S9 + 5 T131
P7289	1 S7 + 3 T141	P7336	1 S8 + 4 T141	P7383	1 S9 + 5 T141
P7290	1 S7 + 3 T151	P7337	1 S8 + 4 T151	P7384	1 S9 + 5 T151
P7291	1 S7 + 3 T161	P7338	1 S8 + 4 T161	P7385	1 S9 + 5 T161
P7292	2 S7 + 6 T81	P7339	2 S8 + 8 T81	P7386	2 S9 + 10 T81
P7293	2 S7 + 3 T81 + 3 T91	P7340	2 S8 + 4 T81 + 4 T91	P7387	2 S9 + 5 T81 + 5 T91
P7294	2 S7 + 6 T91	P7341	2 S8 + 8 T91	P7388	2 S9 + 10 T91
P7295	2 S7 + 3 T91 + 3 T101	P7342	2 S8 + 4 T91 + 4 T101	P7389	2 S9 + 5 T91 + 5 T101
P7296	2 S7 + 6 T101	P7343	2 S8 + 8 T101	P7390	2 S9 + 10 T101
P7297	2 S7 + 3 T111 + 3 T111	P7344	2 S8 + 4 T101 + 4 T111	P7391	2 S9 + 5 T101 + 5 T111
P7298	2 S7 + 6 T111	P7345	2 S8 + 8 T111	P7392	2 S9 + 10 T111
P7299	2 S7 + 3 T111 + 3 T131	P7346	2 S8 + 4 T111 + 4 T131	P7393	2 S9 + 5 T111 + 5 T131
P7300	2 S7 + 6 T131	P7347	2 S8 + 8 T131	P7394	2 S9 + 10 T131
P7301	2 S7 + 3 T131 + 3 T141	P7348	2 S8 + 4 T131 + 4 T141	P7395	2 S9 + 5 T131 + 5 T141
P7302	2 S7 + 6 T141	P7349	2 S8 + 8 T141	P7396	2 S9 + 10 T141
P7303	2 S7 + 3 T141 + 3 T151	P7350	2 S8 + 4 T141 + 4 T151	P7397	2 S9 + 5 T141 + 5 T151
P7304	2 S7 + 6 T151	P7351	2 S8 + 8 T151	P7398	2 S9 + 10 T151
P7305	2 S7 + 3 T151 + 3 T161	P7352	2 S8 + 4 T151 + 4 T161	P7399	2 S9 + 5 T151 + 5 T161
P7306	2 S7 + 6 T161	P7353	2 S8 + 8 T161	P7400	2 S9 + 10 T161
P7307	3 S7 + 6 T101 + 3 T111	P7354	3 S8 + 8 T101 + 4 T111	P7401	3 S9 + 10 T101 + 5 T111
P7308	3 S7 + 3 T101 + 6 T111	P7355	3 S8 + 4 T101 + 8 T111	P7402	3 S9 + 5 T101 + 10 T111
P7309	3 S7 + 9 T111	P7356	3 S8 + 12 T111	P7403	3 S9 + 15 T111
P7310	3 S7 + 6 T111 + 3 T131	P7357	3 S8 + 8 T111 + 4 T131	P7404	3 S9 + 10 T111 + 5 T131
P7311	3 S7 + 3 T111 + 6 T131	P7358	3 S8 + 4 T111 + 8 T131	P7405	3 S9 + 5 T111 + 10 T131
P7312	3 S7 + 9 T131	P7359	3 S8 + 12 T131	P7406	3 S9 + 15 T131
P7313	3 S7 + 6 T131 + 3 T141	P7360	3 S8 + 8 T131 + 4 T141	P7407	3 S9 + 10 T131 + 5 T141
P7314	3 S7 + 3 T131 + 6 T141	P7361	3 S8 + 4 T131 + 8 T141	P7408	3 S9 + 5 T131 + 10 T141
P7315	3 S7 + 9 T141	P7362	3 S8 + 12 T141	P7409	3 S9 + 15 T141
P7316	3 S7 + 6 T141 + 3 T151	P7363	3 S8 + 8 T141 + 4 T151	P7410	3 S9 + 10 T141 + 5 T151
P7317	3 S7 + 3 T141 + 6 T151	P7364	3 S8 + 4 T141 + 8 T151	P7411	3 S9 + 5 T141 + 10 T151
P7318	3 S7 + 9 T151	P7365	3 S8 + 12 T151	P7412	3 S9 + 15 T151
P7319	3 S7 + 6 T151 + 3 T161	P7366	3 S8 + 8 T151 + 4 T161	P7413	3 S9 + 10 T151 + 5 T161
P7320	3 S7 + 3 T151 + 6 T161	P7367	3 S8 + 4 T151 + 8 T161	P7414	3 S9 + 5 T151 + 10 T161
P7321	3 S7 + 9 T161	P7368	3 S8 + 12 T161	P7415	3 S9 + 15 T161
P7322	4 S7 + 6 T111 + 6 T131	P7369	4 S8 + 8 T111 + 8 T131	P7416	4 S9 + 10 T111 + 10 T131
P7323	4 S7 + 3 T111 + 9 T131	P7370	4 S8 + 4 T111 + 12 T131	P7417	4 S9 + 5 T111 + 15 T131
P7324	4 S7 + 12 T131	P7371	4 S8 + 16 T131	P7418	4 S9 + 20 T131
P7325	4 S7 + 3 T141 + 9 T131	P7372	4 S8 + 4 T141 + 12 T131	P7419	4 S9 + 5 T141 + 15 T131
P7326	4 S7 + 6 T131 + 6 T141	P7373	4 S8 + 8 T131 + 8 T141	P7420	4 S9 + 10 T131 + 10 T141
P7327	4 S7 + 3 T131 + 9 T141	P7374	4 S8 + 4 T131 + 12 T141	P7421	4 S9 + 5 T131 + 15 T141
P7328	4 S7 + 12 T141	P7375	4 S8 + 16 T141	P7422	4 S9 + 20 T141

Breakdown of shelving sets 115

Desglose conjuntos de estanterías
Décomposition kits rayonnages

DEPTH 55,5 cm. Suitable for 1/1 GASTRONORM

FONDO 55,5 cm. Adaptable a GASTRONORM 1/1

PROFONDEUR 55,5 cm. Adaptable aux GASTRONORME 1/1

REF. 3 levels 3 niveles 3 niveaux	Breakdown Desglose Décomposition	REF. 4 levels 4 niveles 4 niveaux	Breakdown Desglose Décomposition	REF. 5 levels 5 niveles 5 niveaux	Breakdown Desglose Décomposition
P7423	1 S1 + 3 T6	P7470	1 S2 + 4 T6	P7517	1 S3 + 5 T6
P7424	1 S1 + 3 T7	P7471	1 S2 + 4 T7	P7518	1 S3 + 5 T7
P7425	1 S1 + 3 T8	P7472	1 S2 + 4 T8	P7519	1 S3 + 5 T8
P7426	1 S1 + 3 T9	P7473	1 S2 + 4 T9	P7520	1 S3 + 5 T9
P7427	1 S1 + 3 T10	P7474	1 S2 + 4 T10	P7521	1 S3 + 5 T10
P7428	1 S1 + 3 T11	P7475	1 S2 + 4 T11	P7522	1 S3 + 5 T11
P7429	1 S1 + 3 T13	P7476	1 S2 + 4 T13	P7523	1 S3 + 5 T13
P7430	1 S1 + 3 T14	P7477	1 S2 + 4 T14	P7524	1 S3 + 5 T14
P7431	1 S1 + 3 T15	P7478	1 S2 + 4 T15	P7525	1 S3 + 5 T15
P7432	1 S1 + 3 T16	P7479	1 S2 + 4 T16	P7526	1 S3 + 5 T16
P7433	2 S1 + 6 T8	P7480	2 S2 + 8 T8	P7527	2 S3 + 10 T8
P7434	2 S1 + 3 T8 + 3 T9	P7481	2 S2 + 4 T8 + 4 T9	P7528	2 S3 + 5 T8 + 5 T9
P7435	2 S1 + 6 T9	P7482	2 S2 + 8 T9	P7529	2 S3 + 10 T9
P7436	2 S1 + 3 T9 + 3 T10	P7483	2 S2 + 4 T9 + 4 T10	P7530	2 S3 + 5 T9 + 5 T10
P7437	2 S1 + 6 T10	P7484	2 S2 + 8 T10	P7531	2 S3 + 10 T10
P7438	2 S1 + 3 T10 + 3 T11	P7485	2 S2 + 4 T10 + 4 T11	P7532	2 S3 + 5 T10 + 5 T11
P7439	2 S1 + 6 T11	P7486	2 S2 + 8 T11	P7533	2 S3 + 10 T11
P7440	2 S1 + 3 T11 + 3 T13	P7487	2 S2 + 4 T11 + 4 T13	P7534	2 S3 + 5 T11 + 5 T13
P7441	2 S1 + 6 T13	P7488	2 S2 + 8 T13	P7535	2 S3 + 10 T13
P7442	2 S1 + 3 T13 + 3 T14	P7489	2 S2 + 4 T13 + 4 T14	P7536	2 S3 + 5 T13 + 5 T14
P7443	2 S1 + 6 T14	P7490	2 S2 + 8 T14	P7537	2 S3 + 10 T14
P7444	2 S1 + 3 T14 + 3 T15	P7491	2 S2 + 4 T14 + 4 T15	P7538	2 S3 + 5 T14 + 5 T15
P7445	2 S1 + 6 T15	P7492	2 S2 + 8 T15	P7539	2 S3 + 10 T15
P7446	2 S1 + 3 T15 + 3 T16	P7493	2 S2 + 4 T15 + 4 T16	P7540	2 S3 + 5 T15 + 5 T16
P7447	2 S1 + 6 T16	P7494	2 S2 + 8 T16	P7541	2 S3 + 10 T16
P7448	3 S1 + 6 T10 + 3 T11	P7495	3 S2 + 8 T10 + 4 T11	P7542	3 S3 + 10 T10 + 5 T11
P7449	3 S1 + 3 T10 + 6 T11	P7496	3 S2 + 4 T10 + 8 T11	P7543	3 S3 + 5 T10 + 10 T11
P7450	3 S1 + 9 T11	P7497	3 S2 + 12 T11	P7544	3 S3 + 15 T11
P7451	3 S1 + 6 T11 + 3 T13	P7498	3 S2 + 8 T11 + 4 T13	P7545	3 S3 + 10 T11 + 5 T13
P7452	3 S1 + 3 T11 + 6 T13	P7499	3 S2 + 4 T11 + 8 T13	P7546	3 S3 + 5 T11 + 10 T13
P7453	3 S1 + 9 T13	P7500	3 S2 + 12 T13	P7547	3 S3 + 15 T13
P7454	3 S1 + 6 T13 + 3 T14	P7501	3 S2 + 8 T13 + 4 T14	P7548	3 S3 + 10 T13 + 5 T14
P7455	3 S1 + 3 T13 + 6 T14	P7502	3 S2 + 4 T13 + 8 T14	P7549	3 S3 + 5 T13 + 10 T14
P7456	3 S1 + 9 T14	P7503	3 S2 + 12 T14	P7550	3 S3 + 15 T14
P7457	3 S1 + 6 T14 + 3 T15	P7504	3 S2 + 8 T14 + 4 T15	P7551	3 S3 + 10 T14 + 5 T15
P7458	3 S1 + 3 T14 + 6 T15	P7505	3 S2 + 4 T14 + 8 T15	P7552	3 S3 + 5 T14 + 10 T15
P7459	3 S1 + 9 T15	P7506	3 S2 + 12 T15	P7553	3 S3 + 15 T15
P7460	3 S1 + 6 T15 + 3 T16	P7507	3 S2 + 8 T15 + 4 T16	P7554	3 S3 + 10 T15 + 5 T16
P7461	3 S1 + 3 T15 + 6 T16	P7508	3 S2 + 4 T15 + 8 T16	P7555	3 S3 + 5 T15 + 10 T16
P7462	3 S1 + 9 T16	P7509	3 S2 + 12 T16	P7556	3 S3 + 15 T16
P7463	4 S1 + 6 T11 + 6 T13	P7510	4 S2 + 8 T11 + 8 T13	P7557	4 S3 + 10 T11 + 10 T13
P7464	4 S1 + 3 T11 + 9 T13	P7511	4 S2 + 4 T11 + 12 T13	P7558	4 S3 + 5 T11 + 15 T13
P7465	4 S1 + 12 T13	P7512	4 S2 + 16 T13	P7559	4 S3 + 20 T13
P7466	4 S1 + 3 T14 + 9 T13	P7513	4 S2 + 4 T14 + 12 T13	P7560	4 S3 + 5 T14 + 15 T13
P7467	4 S1 + 6 T13 + 6 T14	P7514	4 S2 + 8 T13 + 8 T14	P7561	4 S3 + 10 T13 + 10 T14
P7468	4 S1 + 3 T13 + 9 T14	P7515	4 S2 + 4 T13 + 12 T14	P7562	4 S3 + 5 T13 + 15 T14
P7469	4 S1 + 12 T14	P7516	4 S2 + 16 T14	P7563	4 S3 + 20 T14

12 Equipment

Maquinaria
Équipement



12.1 COOKING 288

COCCIÓN / COUSSION

Induction units / Placas inducción / Plaque induction 288

Warming induction units / Placas inducción mantenedoras / Plaque induction de maintien température 292

Ovens & micro-waves / Hornos y micro-ondas / Fourset micro-ondes 294

Fryers / Freidoras / Friteuses 295

12.2 TOASTERS & CONTACT GRILLS 296

TOSTADORAS Y GRILL DE CONTACTO

TOASTEURS ET GRILL DE CONTACT

Toasters / Tostadoras / Toasteurs 296

Contact grill / Grill de contacto / Grill de contact 301

12.3 FOOD PROCESSORS 302

PROCESADORES DE ALIMENTOS / ROBOTS MULTIFONCTION

Mixers / Batidoras planetarias / Mélangeurs 302

Slicing machines / Corta fiambres / Trancheurs 303

12.4 FOOD WARMING EQUIPMENT 304

MAQUINARIA MANTENEDORA DE TEMPERATURA

APPAREILS DE MAINTEN DE TEMPEÉRATURE

Rethermalizers / Retermalizadores / Appareil de remise en température 304

Bain marie / Baños maría / Bain-marie 310

Heating lamps / Lámparas mantenedoras / Lampe chauffante 315

Warming equipment / Mantenedores de temperatura / Maintenance de température 318

Hot banquet trolleys / Armarios calientes / Armoires chaudes 319

12.5 ICE-CREAM MACHINES 322

MAQUINARIA HELADERÍA / TURBINES À GLACE

Induction hobs

Placas inducción
Plaques induction

The new way of cooking: more efficient, faster, safer and more precise.

La nueva forma de cocinar: más eficiente, más rápida, más segura y más precisa.

La nouvelle manière de cuisiner : plus efficace, plus rapide, plus sûre et plus précise.

Energy efficient

Eficiencia energética
Efficacité énergétique

The electromagnetic field produced by induction hobs transmits the heat directly to the pan, avoiding the dispersal of energy that happens when cooking with gas.

El campo electromagnético producido por las placas de inducción transmite el calor directamente a la pieza evitando la dispersión de energía que se genera cocinando con gas.

Le champ électromagnétique produit par les plaques à induction transmet la chaleur directement à la pièce en évitant la déperdition d'énergie générée quand on cuisine au gaz.

Speed / Rapidez / Rapidité

As heat is directly transmitted to the pan, it will be concentrated where it is needed, saving both energy and time.

Siendo transmitido directamente a la olla, el calor, se concentra donde se necesita ahorrando energía y, obviamente, tiempo.

La chaleur étant transmise directement à la casserole, elle se concentre là où elle est nécessaire en économisant de l'énergie et, bien sûr, du temps.

Precision / Precisión / Précision

Thanks to their sensitivity, induction hobs give the chef an unbeatable ability to control the heat when compared to traditional hobs.

Gracias a su sensibilidad, las placas de inducción conceden al cocinero una capacidad de control incomparable con las cocinas tradicionales.

Grâce à leur sensibilité, les plaques à induction offrent au cuisinier une capacité de contrôle sans comparaison avec les cuisinières traditionnelles.

Safety / Seguridad / Sécurité

Without anything on the hob to activate the magnetic field, the induction hobs do not heat up.

Sin una pieza específica que active el campo magnético, las placas de inducción no se calientan.

À défaut d'une pièce adaptée capable d'activer le champ magnétique, les plaques ne chauffent pas.

Induction hobs

Placas inducción
Plaques induction

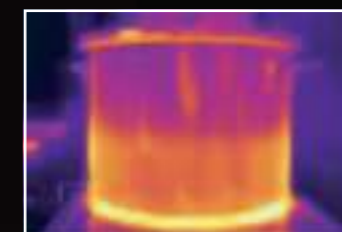

Induction hob
Cocina de inducción
Cuisinière à induction

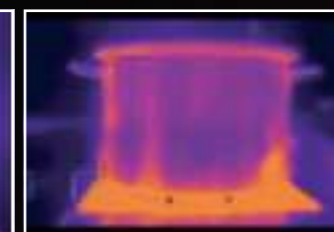

Gas hob
Cocina de gas
Cuisinière à gaz



Which induction unit do you need?

¿Qué placa de inducción necesita?
Quel plaque induction vous faut-il ?



Cooking
Cocinado
Cuisson

Temperature maintenance
Mantenimiento temperatura
Maintien en température

BRAND MARCA MARQUE	VOLLRATH						pujadas A VOLLRATH COMPANY					VOLLRATH		
MODEL MODELO MODÈLE	HPI4	59650	59601	6954702	69523	6958302	P15078	P15072	P15079	P15077	P688065	595027502	595087502	59641
POWER POTENCIA PUISSANCE (W)	3.800 W	1.800 W	1.800 W	3.800 W	5.800 W	3.000 W	3.500 W	3.500 W	3.500 W	2.000 W	3.100 W	300 W	375 W	650 W
MAX. DIAM. DIÁMETRO MÁX. DIAMÈTRE MAX.	35,6 cm	26 cm	30,5 cm	30 x 2 cm	30 x 2 cm	35 cm	26 cm	26 cm	26 cm	26 cm	40 cm	40 cm	60 cm	36 cm
HEAT DISSIP. DISIP. CALOR DISSIP. CHALEUR														
TYPE TIPO TYPE	Counter-top Sobremesa À poser sur table	Counter-top Sobremesa À poser sur table	Be built-in Encastrable Encastrable	Counter-top Sobremesa À poser sur table	Counter-top Sobremesa À poser sur table	Counter-top Sobremesa À poser sur table	Counter-top Sobremesa À poser sur table	Counter-top Sobremesa À poser sur table	Counter-top Sobremesa À poser sur table	Counter-top Sobremesa À poser sur table	Counter-top Sobremesa À poser sur table	Counter-top Sobremesa À poser sur table	Counter-top Sobremesa À poser sur table	Be built-in Encastrable Encastrable
SUITABLE APTO CONVIENT	Pots / Pans Ollas / Sartenes Casseroles / Poêles	Pots / Pans Ollas / Sartenes Casseroles / Poêles	Pots / Pans Ollas / Sartenes Casseroles / Poêles	Pots / Pans Ollas / Sartenes Casseroles / Poêles	Pots / Pans Ollas / Sartenes Casseroles / Poêles	Wok	Pots / Pans Ollas / Sartenes Casseroles / Poêles	Pots / Pans Ollas / Sartenes Casseroles / Poêles	Pots / Pans Ollas / Sartenes Casseroles / Poêles	Pots / Pans Ollas / Sartenes Casseroles / Poêles	Wok	Pots / Chaffing dishes Ollas / Chaffing Casseroles / Chauffe- plats	Pots / Chaffing dishes Ollas / Chaffing Casseroles / Chauffe- plats	Pots / Chaffing dishes Ollas / Chaffing Casseroles / Chauffe- plats
USE USO USAGE	Intensive Intensivo Intensif	Semi-intensive Semi-intensivo Semi-intensif	Semi-intensive Semi-intensivo Semi-intensif	Intensive Intensivo Intensif	Intensive Intensivo Intensif	Semi-intensive Semi-intensivo Semi-intensif	Semi-intensive Semi-intensivo Semi-intensif	Semi-intensive Semi-intensivo Semi-intensif	Semi-intensive Semi-intensivo Semi-intensif	Moderate Moderado Modéré	Semi-intensive Semi-intensivo Semi-intensif	Intensive Intensivo Intensif	Intensive Intensivo Intensif	Intensive Intensivo Intensif

EQUIPMENT
MAQUINARIA
EQUIPEMENT

EQUIPMENT
MAQUINARIA
EQUIPEMENT

12.1 Induction units

Placas de inducción
Plaque induction

4-Series

IT'S LIKE COOKING WITH GAS, ONLY BETTER!

Es como cocinar con gas, ¡solo que mejor!
Comme la cuisine au gaz, mais en mieux!

93 %
Efficiency
Eficiencia
Efficacité

100
Power levels
Niveles de potencia
Niveaux de puissance

27-232 °C
Temperature levels
Niveles de temperatura
Niveaux de température

24 h
Timer with audible alarm
Temporizador con alarma sonora
Minuterie avec alarme sonore

Heavy-duty usage
Uso intensivo
Intensif usage

Expanded magnetic field emulates gas to allow uninterrupted heat while lifting or tilting pan.

New smarter, faster pan detection technology delivers immediate heat when placing a pan on the surface.

Four customizable programs deliver repeatable results with the touch of a button.

El campo magnético expandido emula el gas para proporcionar un calor ininterrumpido mientras se levanta la sartén.

La nueva tecnología de detección más inteligente y rápida proporciona calor inmediato cuando se coloca la sartén sobre la superficie.

Cuatro programas personalizables ofrecen resultados repetibles con solo pulsar un botón.

Champ magnétique étendu qui imite la cuisson au gaz pour permettre une chaleur ininterrompue si la poêle est soulevée ou inclinée.

Nouvelle technologie de détection, plus intelligente et plus rapide qui apporte une chaleur immédiate lorsque la poêle est placée sur la surface.

Quatre programmes personnalisables avec des résultats répétables en appuyant sur un seul bouton.

Ceramic glass cooking surface
Superficie de cocción de cristal vitrocerámico
Surface de cuisson vitrocéramique

Improved control knob with power and temperature level adjustment
Nuevo y mejorado mando de control de temperatura y potencia
Nouveau bouton de contrôle de la température et la puissance amélioré

Touch screen control panel
Panel de control con pantalla táctil
Panneau de commande à écran tactile

Redesigned sleek heavy-duty stainless steel case with improved ventilation
Nueva caja de acero inoxidable para uso intensivo con ventilación mejorada
Nouveau boîtier en acier inoxydable pour usage intensif avec ventilation améliorée.

Temperature control probe
Sonda de control de temperatura
Sonde de contrôle de température



NEW!

HPI4 High power induction

Placa de inducción control temperatura
Plaque à induction contrôle température

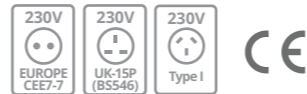

REF	CA/AC Volt.	W	A	Plug Ench.	Hz	☐
HPI4-260002	230	2.600	11.3	EU	50/60	1
HPI4-260003	230	2.600	11.3	UK	50/60	1
HPI4-260004	230	2.600	11.3	CH	50/60	1
HPI4-300002	230	3.000	13	EU	50/60	1
HPI4-300003	230	3.000	13	UK	50/60	1
HPI4-300004	230	3.000	13	CH	50/60	1
HPI4-380002	230	3.800	16.5	EU	50/60	1
HPI4-380003	230	3.800	16	UK	50/60	1
HPI4-380004	230	3.800	16.5	CH	50/60	1



Induction units 121

Placas de inducción
Plaque induction

mirage® INDUCTION

90 %
Efficiency
Eficiencia
Efficacité

100
Power levels
Niveles de potencia
Niveaux de puissance

60-205 °C
Temperature levels
Niveles de temperatura
Niveaux de température

1-180 min
Timer
Temporizador
Minuterie

Medium-duty usage
Uso semi-intensivo
Semi-intensif usage

Temperature memory — powers up to the last used temperature setting.

Memoria de temperatura — permite usar el último ajuste de temperatura programado.

Mémoire de température — offre la possibilité d'utiliser le dernier réglage de température.

Ceramic glass cooking surface
Superficie de cocción de cristal vitrocerámico
Surface de cuisson vitrocéramique

Control knob with power and temperature level adjustment
Mando de selección de temperatura y potencia
Cadran de réglage de température et de puissance

Soft-touch control panel
Panel de control táctil
Panneau de commande tactile

Tough stainless steel case
Resistente caja de acero inoxidable
Boîtier inox solide



59650 Induction cooker Placa inducción Plaque induction



REF	Ø Mâx cm	V	W	A	Plug Ench.	Hz	☐
59650	26	230	1.800	7,8	EU	50/60	1
59651	26	230	1.800	7,8	UK	50/60	1

59601 Drop in induction cooker Placa inducción encastrable Plaque induction encastrable

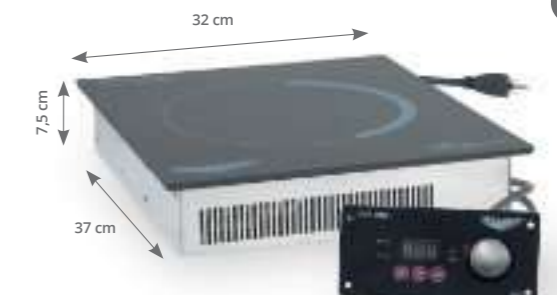
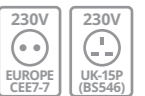

REF	Ø Mâx cm	cm	V	W	A	Plug Ench.	Hz	☐
59601	30,5	34 x 30	230	1.800	7,8	EU	50/60	1
59602	30,5	34 x 30	230	1.800	7,8	UK	50/60	1

12.1 Induction units

Placas de inducción
Plaque induction

69547 Double induction plate
Placa inducción doble
Plaque à induction double

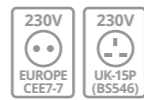

1.900W x 2



REF	Ø cm	V	W	A	Plug Ench.	Hz	⊠
6954702	30 x 2	208-240	3.800	15,8	EU	50/60	1
6954703	30 x 2	208-240	3.800	15,8	UK	50/60	1

69523 Double induction plate
Placa inducción doble
Plaque à induction double



2.900W x 2



REF	Ø cm	V	W	A	Plug Ench.	Hz	⊠
69523	30 x 2	208-240	5.800	24,1	NEMA	50/60	1

P15078 Induction cooker
Placa de inducción
Plaque à induction



REF	Ø Màx cm	V	W	Hz	⊠
P15078	26	220 - 240	3.500	50/60	1

St/steel housing. Timer. LED display (0-180 minutes). Touch control. 1-10 Power level (500-3500W). Temperatures: 60-240 °C. Four fans.

Cuerpo en acero inoxidable. Reloj temporizador (0-180 minutos). Pantalla LED con control táctil. Regulador de temperatura 1-10 (500-3500W). Rango temperatura 60-240 °C. Cuatro ventiladores de refrigeración.

Corps en acier inoxydable. Minuteur. Ecran LED (0-180 minutes). Tactile. 1-10 Niveau de puissance (500-3500W). Temperatures: 60-240 °C. Quatre ventilateurs.

P15072 Induction cooker
Placa de inducción
Plaque à induction



REF	Ø Màx cm	V	W	Hz	⊠
P15072	26	230	3.500	50/60	1

St/Steel housing. Digital regulation of time 0-180 minutes. Thermostat 60-240 °C and power 500-3500 W. 4 Fans.

Cuerpo en acero inoxidable. Mando digital de tiempo de 0-180 minutos. Temperatura de 60-240 °C. Potencia de 500-3500 W. 4 Ventiladores.

Corps en acier inoxydable. Minuterie digitale de 0-180 minutes. Température de 60-240 °C. Puissance: 500-3500 W. 4 Ventilateurs.

Induction units 121

Placas de inducción
Plaque induction

P15079 Induction cooker
Placa de inducción
Plaque à induction



REF	Ø Màx cm	V	W	Hz	⊠
P15079	26	230	3.500	50/60	1

St/steel housing. Timer. LED display (0-180 minutes). Temperatures: 60-240 °C. One fan.

Cuerpo en acero inoxidable. Reloj temporizador (0-180 minutos). Pantalla LED. Rango temperatura 60-240 °C. Un ventilador de refrigeración.

Corps en acier inoxydable. Minuteur. Ecran LED (0-180 minutes). Temperatures: 60-240 °C. Un ventilateur.

P15077 Induction cooker
Placa de inducción pequeña
Plaque induction petite



REF	Ø Màx cm	V	W	Hz	⊠
P15077	26	230	2.000	50/60	1

Plastic housing with touch control LCD panel. Timer (0-180 minutes). Temperatures: 60-240 °C.

Cuerpo en plástico con panel control táctil LCD. Reloj temporizador (0-180 minutos). Rango temperaturas: 60-240 °C.

Corps en plastique avec écran LCD tactile. Minuteur (0-180 minutes). Temperatures: 60-240 °C.

P688065 Wok induction cooker
Placa de inducción wok
Plaque à induction wok



REF	Ø cm	V	W	Plug Ench.	Hz	⊠
P688065	36/40	220-240	3.100	EU	50/60	1

St/steel housing. Timer (0-180 minutes). LED display. Temperatures: 60-240 °C. 4 fans.

Cuerpo en acero inoxidable. Reloj temporizador (0-180 minutos). Pantalla LED. Temperatura 60-240 °C. 4 ventiladores.

Corps en acier inoxydable. Minuteur (0-180 minutes). Ecran LED. Temperatures: 60-240 °C. 4 ventilateurs.

6958302 Placa de inducción control wok 35 cm
Placa de inducción wok 35 cm
Plaque à induction contrôle wok 35 cm



REF	CA/AC Volt.	W	A	Plug Ench.	Hz	⊠
6958302	208-240	3000	14.6	EU	50/60	1
6958303	208-240	3000	14.6	UK	50/60	1

Includes a carbon steel wok. High efficiency of induction to provide gas-like performance. 100 power settings for precise cooking control.

Incluye un wok de acero al carbono. Alta eficiencia de inducción para proporcionar un rendimiento similar al del gas. 100 configuraciones de potencia para un control preciso de la cocción.

Comprend une poêle wok en acier au carbone. Haute efficacité d'induction pour fournir des performances similaires à celles d'un gaz. 100 réglages de puissance pour un contrôle précis de la cuisson.

121 Warming induction units

Placas inducción mantenedoras
Plaque induction de maintien température

mirage[®]
INDUCTION



INDUCTION



BUFFET INDUCTION WARMER BUFET CALENTADORES INDUCCIÓN BUFFET RECHAUD INDUCTION

Low wattage to keep food warm during serving.
Mantener la comida caliente durante el servicio.
Faible puissance pour garder les aliments au chaud pendant le service.

With less than 400W, it is the most efficient and eco-friendly system on the market.

Con menos de 400W son el sistema más eficiente y eco-friendly del mercado.

Avec moins de 400 W c'est le système le plus efficace et eco-friendly du marché.



Tempered, black glass top.
Parte superior de cristal templado negro.
Plateau en verre noir trempé.

Touch control, 4 power settings. LED indicator lights on control panel & glass.
Con 4 ajustes de potencia. Indicadores luminosos LED en el panel de control.
Contrôle tactile, 4 réglages de puissance. Voyants LED lumineux sur le panneau de commande et verre.



Connect up to 3 units together with interconnect cords.
Conecte hasta 3 placas a la vez.
Connectez jusqu'à 3 unités avec des cordons d'interconnexion.

Warming induction units 121

Placas inducción mantenedoras
Plaque induction de maintien température

595027502 Buffet induction warmer Placa inducción mantenedora de temperatura Plaque induction de maintien température



595087502
595087503



595027502
595027503

REF	W x D x H cm	CA/AC Volt.	W	A	Plug Ench.	Hz	📦
595027502	40 x 40 x 8	230	300	1,30	EU	50/60	1
595027503	40 x 40 x 8	230	300	1,30	UK	50/60	1
595087502	60 x 40 x 8	230	375	1,63	EU	50/60	1
595087503	60 x 40 x 8	230	375	1,63	UK	50/60	1

59641 Drop in warmer Placa inducción mantenedora de temperatura encastrable Plaque induction de maintien température encastrable

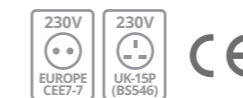

* Drop in
Encastrable
Encastrable

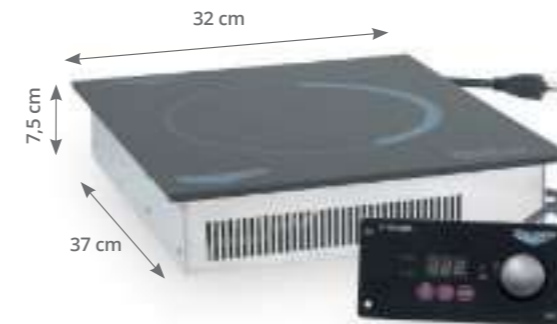

REF	Ø Mâx cm	cm*	CA/AC Volt.	W	A	Plug Ench.	Hz	📦
59641	36	34 x 30	230	650	2,8	EU	50/60	1
59642	36	34 x 30	230	650	2,8	UK	50/60	1

121 Ovens & micro-waves

Hornos y micro-ondas
Fourset micro-ondes

P15035 Convection oven
Horno multifuncional de convección
Four à air pulse



REF	Grill / Rejilla / Grille	V	W	Hz	
P15035	43 x 32	230	2.670	50/60	1

4 grids included
4 rejillas incluidas
4 grilles incluses

Timer, indicator lights, thermostat, (max. 300 °C) thermal cut-out and double glass.

Temporizador, pilotos luminosos, termostato (max. 300 °C), termostato de seguridad y doble vidrio anti-quemaduras.

Avec minuterie, voyants lumineux, thermostat (max. 300 °C), thermostat de sécurité et avec double vitre. mostat, thermostat de sécurité et avec vitre double

P688085 Rice cooker
Hervidor de arroz
Cuisneur à riz



REF	Ø cm	Rice cap. Cap. arroz Riz cap. Kg	Lts	H cm	V	W	Hz	
P688085	46	3,0	5,40	40	220-230	1950	50/60	1
P688087	56	6,1	8,20	40	220-240	2500	50/60	1

VOLLRATH

P15081 Combi micro - wave
Microondas combi
Four micro - ondas



10 Power levels
Niveles de potencia
Niveaux de puissance



REF	Lts	Inner sizes / Dim int / Dim. int. cm	V	Max W	Hz	
P15081	25,0	33,5 x 33,5 x 17	230	1.950	50	1

Input: 1.400 W
Output: 900 W
Convection / Convección: 1.950 W

Glass round dish 27 cm diameter
Plato giratorio 27 cm diametro
Plateau tournant 27 cm diametre

Functions: defrosting, baking and heating
Funciones: descongelar, gratinar y calentar
Fonctions: décongeler, gratiner et chauffer

P15075 Crêpe maker
Crêpera
Crêpière

Thermostat
Termostato
Thermostat:
Temp. Max 300 °C



St/Steel with cast iron teflon coated plates. Indicator light, drawer/warming tray and batter spreader.

Acero inoxidable con planchas de hierro fundido teflonadas.
Indicador temperatura, cajón y espátula.

Acier inoxydable avec plaques en fonte avec revêtement en téflon.
Témoins de contrôle, tiroir/plaque chauffante et étaleur de pâte.

REF	Ø cm	cm	V	W	Hz	
P15075	40	45 x 49	230	3.000	50/60	1

294

pujadas

Fryers 121

Freidoras
Friteuses

18/10
Stainless
steel

Temperature control up to 190°C
Temperatura variable hasta 190°C
Température variable jusqu'à 190°C

P15070 5 Lts fryer
Freidora 5 Lts
Friteuse 5 Lts



REF	Lts	V	W	Hz	
P15070	5,00	230	2.000	50/60	1

Basket size / Medida cesta / Mesure panier 21 x 14 x 12,5 cm

P15000 8 Lts Fryer
Freidora 8 Lts
Friteuse 8 Lts



REF	Lts	V	W	Hz	
P15000	8,00	230	3.250	50/60	1

Basket size / Medida cesta / Mesure panier 24 x 18 x 14 cm

P15002 8 Lts fryer with drainage tap
Freidora 8 Lts con grifo de vaciado
Friteuse 8 Lts avec robinet vidange



REF	Lts	V	W	Hz	
P15002	8,00	230	3.250	50/60	1

Basket size / Medida cesta / Mesure panier 24 x 18 x 14 cm

VOLLRATH

P15071 5+5 Lts fryer
Freidora 5+5 Lts
Friteuse 5+5 Lts



REF	Lts	V	W	Hz	
P15071	5,00+5,00	2 x 230	2 x 2.000	50/60	1

Basket size / Medida cesta / Mesure panier 21 x 14 x 12,5 cm

P15001 8+8 Lts Fryer
Freidora 8+8 Lts
Friteuse 8+8 Lts



REF	Lts	V	W	Hz	
P15001	8,00+8,00	2 x 230	2 x 3.250	50/60	1

Basket size / Medida cesta / Mesure panier 24 x 18 x 14 cm

P15003 8+8 Lts fryer with drainage tap
Freidora 8+8 Lts con grifo de vaciado
Friteuse 8+8 Lts avec robinet vidange



REF	Lts	V	W	Hz	
P15003	8,00+8,00	2 x 230	2 x 3.250	50/60	1

Basket size / Medida cesta / Mesure panier 24 x 18 x 14 cm

295

pujadas

EQUIPMENT
MAQUINARIA
EQUIPEMENT

EQUIPMENT
MAQUINARIA
EQUIPEMENT

12.2 Toasters

Tostadoras
Toaster



Save up to 75% energy*
Ahorre hasta un 75% de energía*
Économisez jusqu'à 75% d'énergie*

CONVEYOR TOASTERS
Forced convection and energy-efficient quartz resistors provide a uniform and fast toasting.

* The Stand by function saves 75% of energy during periods of low demand.

TOSTADORAS CON CORREA TRANSPORTADORA
La convección forzada y las resistencias de cuarzo energéticamente eficientes brindan un tostado uniforme y rápido.

*La función en Stand by permite ahorrar un 75% de energía en el momento de baja demanda.

GRILLE-PAIN CONVOYEURS
La convection forcée et les résistances à quartz énergétiquement efficaces offrent un grillage uniforme et rapide.

*La fonction Stand by permet d'économiser 75% d'énergie aux moments de faible demande.

CT4-230DUAL Dual conveyor toaster
Tostadora transportadora doble
Pain double à convoyeur



NEW!



Conveyor width
Ancho de cinta
Largeur de bande
36,8 cm

Delivered without plug (stripped ends).
Entregado sin clavija.
Livré sans prise.

1100
Slices per hour
Rebanadas por hora
Tranches heure

REF	V	W	Hz	A	⊞
CT4-230DUAL	220-240	4.950	50/60	19,8	1

CT4H-230950 Conveyor toaster
Tostadora continua
Pain à convoyeur



NEW!



Conveyor width
Ancho de cinta
Largeur de bande
36,8 cm

Delivered without plug (stripped ends).
Entregado sin clavija.
Livré sans prise.

950
Slices per hour
Rebanadas por hora
Tranches heure

REF	V	W	Hz	A	⊞
CT4H-230950	220-240	3.600	50/60	14,4	1

Toasters 122

Tostadoras
Toaster

18/10
Stainless steel

CT4-3600W Conveyor toaster
Tostadora continua
Grille - pain à convoyeur



Speed control
Control de velocidad
Contrôle de vitesse

Stand-by system
Sistema stand-by
Système stand-by

Temperature control
Control de temperatura
Contrôle de la température

Conveyor width
Ancho de cinta
Largeur de bande
35,6 cm

Delivered without plug (stripped ends).
Entregado sin clavija.
Livré sans prise.

Replaceable quartz resistance.
Resistencias de cuarzo recambiables.
Résistances à quartz remplaçables.

1.000
Rebanadas por hora
Slices per hour
Tranches heure

REF	V	W	Hz	A	WxDxH cm	⊞
CT4-2301000	230	3.600	50/60	15	35 x 46 x 35,6	1

CT2-1500W Conveyor toaster
Tostadora continua
Grille - pain à convoyeur



Conveyor width
Ancho de cinta
Largeur de bande
26,7 cm



CT4-2800W Conveyor toaster
Tostadora continua
Grille - pain à convoyeur



Speed and temperature control.
Replaceable quartz resistance.

Dispone de control de velocidad y temperatura.
Resistencias de cuarzo recambiables.

Avec contrôle de la vitesse et température. Résistances à quartz remplaçables.

Conveyor width
Ancho de cinta
Largeur de bande
26,7 cm

450-800
Slices per hour
Rebanadas por hora
Tranches heure

REF	V	W	Hz	A	WxDxH cm	Plug Ench.	⊞
CT4-23080002	230	2.800	50/60	12,7	35 x 36 x 60	EU	1
CT4-23080003	230	2.800	50/60	12,7	35 x 36 x 60	UK	1

REF	V	W	Hz	A	WxDxH cm	Plug Ench.	⊞
CT2-23035002	230	1.500	50/60	12,5	35 x 36 x 41	EU	1
CT2-23035003	230	1.500	50/60	12,5	35 x 36 x 41	UK	1

350
Slices per hour
Rebanadas por hora
Tranches heure

Speed control.
Replaceable quartz resistance.

Dispone de control de velocidad.
Resistencias de cuarzo recambiables.

Avec contrôle de la vitesse.
Résistances à quartz remplaçables.

12.2 Toasters

Tostadoras
Toaster



Conveyor heating oven / Horno de cinta / Four chauffant à bande

Designed to heat any type of snack and melt cheese quickly and efficiently. Made of stainless steel with a variable speed control system and temperature control both above and below the conveyor belt. It includes a crumb collection tray. It has a forced convection system and has the possibility of regulating the height of the belt, ensuring uniform toasting and the highest energy efficiency. Two units can be mounted one top of the other with a space-saving accessory.

Diseñado para calentar cualquier tipo de snack y fundir queso de manera rápida y eficiente. Fabricado en acero inoxidable con un sistema de control de la velocidad variable y control de temperatura tanto por encima como por debajo de la cinta. Incluye bandeja para recoger migas. Su sistema de convección forzada y la posibilidad de regular la altura de la cinta, aseguran un tostado uniforme y la mayor eficiencia energética. Pueden remontarse dos unidades al mismo tiempo con un accesorio para ahorrar espacio.

Conçue pour préparer toute sorte de snack et faire fondre le fromage rapidement et efficacement. Fabriqué en acier inoxydable avec un système de contrôle de vitesse variable et un contrôle de température au-dessus comme en-dessous de la bande. Inclut bac de récupération de miettes. Son système de convection forcée et la possibilité de régler la hauteur de la bande, assurent un grillé uniforme et la meilleure efficacité énergétique. Il est possible de remonter deux unités à la fois avec un accessoire pour économiser de l'espace.

SO2-2800W Conveyor heating oven Horno calentador de cinta Four chauffant à bande



26,7 cm

Belt width / Ancho de cinta
Largeur de la bande

3,8 - 7,6 cm

Adjustable entrance height
Altura entrada ajustable
Hauteur de l'entrée réglable

REF	V	W	Hz	A	WxDxH cm	Plug Ench.	Box
SO2-23010.5	230	2.800	50	13,3	34 x 104 x 41	EU	1

SO2-3600W Conveyor heating oven Horno calentador de cinta Four chauffant à bande



36,8 cm

Belt width / Ancho de cinta
Largeur de la bande

3,8 - 7,6 cm

Adjustable entrance height
Altura entrada ajustable
Hauteur de l'entrée réglable

REF	V	W	Hz	A	WxDxH cm	Plug Ench.	Box
SO2-23014.5	230	3.600	50	13,3	39 x 103,5 x 51	EU	1

See products on / Ver productos en / Voir produits en page

P. 446

Wooden bread spoon
Pinza de pan de madera
Pince à pain en bois



Idea! Ideal for handling toast
Ideal para manipular las tostadas
Idéal pour manipuler le pain grillé

Toasters 122

Tostadoras
Toaster



Standard Toasters / Tostadoras Estándar / Toasteurs Standard

P15042 Conveyor toaster Tostadora continua Toasteur convoyeur



500

Rebanadas por hora
Slices per hour
Tranches heure

REF	V	W	Hz	Box
P15042	230	2.240	50/60	1

Toast colour can be determined by conveyor speed as well as by independently controlled heating elements. Units are fully insulated to emit only minimal heat to surroundings. Main switch with extra standby position. The toasters can be used for bread as well as for buns. The toasting belt is suitable for 2 rows for toast, 200 type.

El color de las tostadas puede determinarse por la velocidad de la banda transportadora, así como por las resistencias superior e inferior que se controlan independientemente. El aparato está completamente aislado para que emita un calor mínimo a su alrededor. El interruptor encendido-apagado contempla la posición extra de standby. La longitud de la banda transportadora permite 2 hileras de tostadas (tipo 200).

La couleur du pain se détermine par la vitesse de la bande de transport ainsi que par les résistances contrôlées indépendamment. Les appareils sont isolés entièrement et n'émettent qu'une chaleur minimale à la température ambiante. Interrupteur marche-arrêt qui inclut le mode veille standby. La Largeur de la bande de transport permet 2 rangées de tranches, type 200.

P15038 Sandwich toaster Tostadora Toasteur



80-100

Slices per hour
Rebanadas por hora
Tranches heure

Delivered with 3 sandwich tongs
Se entregan con 3 pinzas para sandwich
Livrées avec 3 pinces à sandwich

REF	V	W	Hz	Box
P15038	230	1.700	50/60	1

Heating elements separately controllable. With timer, drip tray and 4 quartz heating elements.

Las resistencias se pueden controlar por separado. Con temporizador y bandeja limpieza recoge migas. 4 tubos de cuarzo.

Les résistances se contrôlent séparément. Avec minuterie, tiroir ramasse miettes et 4 tubes quartz.

P15039 Sandwich toaster Tostadora Toasteur



120-130

Slices per hour
Rebanadas por hora
Tranches heure

Delivered with 6 sandwich tongs
Se entregan con 6 pinzas para sandwich
Livrées avec 6 pinces à sandwich

REF	V	W	Hz	Box
P15039	230	3.000	50/60	1

2 levels. Heating elements separately controllable. With timer, drip tray and 9 quartz heating elements.

2 niveles. Las resistencias funcionan por separado. Con temporizador, bandeja recoge migas. 9 tubos de cuarzo.

2 niveaux. Les résistances se contrôlent séparément. Avec minuterie, tiroir ramasse miettes et 9 tubes quartz.

12.2 Toasters

Tostadoras
Toaster

P15040 Toaster
Tostadora
Toasteur



120
Rebanadas por hora
Slices per hour
Tranches heure

REF	Slots Ranuras / Fentes	V	W	Hz	
P15040	4	230	1.800	50/60	1

With manual pop up
Con expulsión manual
Avec éjection automatique

All St/Steel construction.
With energy-saving switch to decide how many slices to toast. With timer: 2 or 4
Slot: 2,5 x 14,5 x 14,5 cm.

Fabricada en acero inoxidable.
Con conmutador ahorro energía para decidir la cantidad de rebanadas a tostar: 2 ó 4
Con temporizador.
Ranura: 2,5 x 14,5 x 14,5 cm.

Habillage en acier inoxydable.
Avec commutateur économiseur pour choisir le nombre de tranches à griller: 2 ou 4.
Avec minuterie.
Fente: 2,5 x 14,5 x 14,5 cm.

P15041 Toaster
Tostadora
Toasteur



180
Rebanadas por hora
Slices per hour
Tranches heure

REF	Slots Ranuras / Fentes	V	W	Hz	
P15041	6	230	2.500	50/60	1

With manual pop up
Con expulsión manual
Avec éjection automatique

All St/Steel construction.
With energy-saving switch to decide how many slices to toast. With timer: 2 or 4 or 6
Slot: 2,5 x 14,5 x 14,5 cm.

Fabricada en acero inoxidable.
Con conmutador ahorro energía para decidir la cantidad de rebanadas a tostar: 2 ó 4 ó 6
Con temporizador.
Ranura: 2,5 x 14,5 x 14,5 cm.

Habillage en acier inoxydable.
Avec commutateur économiseur pour choisir le nombre de tranches à griller: 2 ou 4 ou 6
Avec minuterie.
Fente: 2,5 x 14,5 x 14,5 cm.

Contact grill 122

Grillde contacto
Grillde contact



CAST IRON GRIDDLE PLATES ENAMELED.
Large drip tray.
High turned-up spatter rim.
Indicator lights.
Adjustable thermostat to 300 °C.

PLANCHAS DE FUNDICIÓN ESMALTADAS.
Bandeja y recoge jugos.
Borde antisalpicaduras.
Luces piloto.
Termostato ajustable hasta 300 °C.

PLAQUE EN FONTE EMAILLÉES.
Tiroir de propreté.
Bourdre anti projections haute.
Voyants lumineux.
Thermostat réglable jusqu'à 300 °C.

P15004 "Solo compact" Contact grill
Grill de contacto "Solo compact"
Grill de contact "Solo compact"



Upper and lower grooves
Ranura arriba y abajo
Quadrillage en haut et en bas



Temperature control
Control de temperatura
Contrôle de la température



Fat collection tray
Bandeja recoge grasa
Bac de récupération de graisse

REF	Cooking surface Superficie de cocción Surface de cuisson cm	V	W	Hz	
P15004	22 x 23	230	1.800	50/60	1

P15005 "Solo grande" Contact grill
P15006 Grill de contacto "Solo grande"
Grill de contact "Solo grande"



Upper and lower grooves
Ranura arriba y abajo
Quadrillage en haut et en bas
P15005



Upper groove
Ranura arriba
Quadrillage en haut
P15006

REF	Cooking surface Superficie de cocción Surface de cuisson cm	V	W	Hz	
P15005	32 x 21	230	2.200	50/60	1
P15006	32 x 21	230	2.200	50/60	1

P15007 "Duetto compact" Contact grill
P15008 Grill de contacto "Duetto compact"
Grill de contact "Duetto compact"



Upper and lower grooves
Ranura arriba y abajo
Quadrillage en haut et en bas
P15007



Upper groove
Ranura arriba
Quadrillage en haut
P15008

REF	Cooking surface Superficie de cocción Surface de cuisson cm	V	W	Hz	
P15007	47 x 23	230	3.600	50/60	1
P15008	47 x 23	230	3.600	50/60	1

Included on the price
Incluido en el precio
Inclus dans le prix



P181000

12.3 Mixers

Batidoras planetarias
Mélangeurs

Mixers Batidoras planetarias Mélangeurs

Gears and shafts are made of heat-treated alloy steel for long life and quieter operation

Engranajes y ejes de acero de fundición permiten alargar la vida del producto y proporcionan un funcionamiento más silencioso

Engrenages et arbres en acier allié traité à la chaleur pour une longue durée et un fonctionnement plus silencieux

Planetary mixing action
Acción de batido elíptico
Mélangeur planétaire



Thermal overload protection automatically shuts off mixer to protect from damage
Paro automático por sobre calentamiento
Arrêt automatique par la surchauffe

30 minute digital timer with automatic stop and audible shutoff signal
Temporizador digital 30 minutos, con paro automático con señal acústica
Minuterie numérique (30 minutes) à arrêt automatique et signal d'arrêt sonore

Consistent mixing speeds regardless of volume
Velocidades de mezcla constantes independientemente del volumen
Vitesses de mélange uniformes, quel que soit le volume

Safety guard
Protección Seguridad
Protecteur de sécurité

Heavy-duty construction
Construcción extra robusta
Construction robuste

Comes with / Incluye / Livré avec



Wire Wishk
Batidor varilla
Fouet à fil



Dough hook
Gancho para masa
Crochet de pâte



Spatula
Espátula
Spatule



S/Steel mixing bowl
Bol acero inoxidable
Bol mélangeur en acier inoxydable

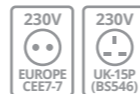

4075502 Countertop Mixers Amasadora sobre mesa Mélangeurs de comptoir

1/3 HP
250 W
3 A
50 Hz



4075503

Digital control panel to make easy speed shifts while unit is running.
Panel de control digital para simplificar el cambio de velocidades mientras la unidad está funcionando.
Panneau de commande numérique pour faciliter les changements de vitesse pendant le fonctionnement de l'appareil

REF	Lts.	W x D x H cm	Speed Velocidad Vitesse	V	Plug Ench.	⊠
4075502	6,6	33,5x45x51,5	5	220-230	EU	1
4075503	6,6	33,5x45x51,5	5	220-230	UK	1
4075602	9,5	33,5x45x54	5	220-230	EU	1
4075603	9,5	33,5 x 45 x 54	5	220-230	UK	1

REF	For / Para / Pour (Lts)	⊠
Wire Wishk / Batidor varilla / Fouet à fil		
XMIX0705	6.6	1
40762	9.5	1
Dough hook / Gancho para masa / Crochet de pâte		
XMIX0704	6.6	1
40763	9.5	1
Spatula / Espátula / Spatule		
XMIX0703	6.6	1
40764	9.5	1
Mixing bowl / Bol acero / Bol mélangeur		
XMIX0702	6.6	1
40761	9.5	1

Slicing machines 123

Corta fiambres
Trancheurs

4075702 Floor-Bench mixers Amasadora de pié Mélangeurs au sol-sur plan de travail



220-230 V
50 Hz



4075702

REF	Lts.	W x D x H cm	Speed Velocidad Vitesse	HP	W	A	Plug Ench.	⊠
4075702	19	52x52x91	3	0,5	370	4	EU	1
4075703	19	52x52x91	3	0,5	370	4	UK	1
4075802	28	64x62x122	3	1,0	750	8	EU	1
4075803	28	64x62x122	3	1,0	750	8	UK	1
4075902	38	68x68x120	3	1,5	1.120	11	EU	1
4075903	38	68x68x120	3	1,5	1.120	11	UK	1

REF	For / Para / Pour (Lts)	⊠
Wire Wishk / Batidor varilla / Fouet à fil		
40766	19	1
40770	28	1
40774	38	1
Dough hook / Gancho para masa / Crochet de pâte		
40767	19	1
40771	28	1
40775	38	1
Spatula / Espátula / Spatule		
40768	19	1
40772	28	1
40776	38	1
Mixing bowl / Bol acero / Bol mélangeur		
40765	19	1
40769	28	1
40773	38	1

P15089 / P15090 / P15091 Electric slicing machine Cortadora eléctrica de fiambres Tranchar électrique



Body: painted aluminium.
Cuerpo: aluminio pintado.
Corps: aluminium peint.

REF	V	Hz	W	Ø Blade Cuchilla / Lame	Slicer thickness Espesor corte / Épaisseur de coupe	W x D x H cm	Kg	⊠
P15089	230	50	120	22	0-9	48 x 40 x 37	14,8	1
P15090	230	50	150	25	0-9	48 x 40 x 37	16,0	1
P15091	230	50	250	30	0-11	59 x 38 x 43	22,6	1



P15089
Ø 22 cm Blade / Cuchilla / Lame



P15090
Ø 25 cm Blade / Cuchilla / Lame



P15091
Ø 30 cm Blade / Cuchilla / Lame

See products on / Ver productos en / Voir produits en page

P. 141

Sanitary gel lubricant
Gel lubricante sanitario
Gel lubrifiant sanitaire



Which warming equipment do you need?

¿Qué mantenedor de temperatura necesitas?
 Quel appareil maintenance de température vous faut-il ?



Rethermalizers *Application: Retherm Chilled Food. Hold Heated Food.*
Rethermalizadores *Aplicación: Retermaliza alimentos fríos. Mantiene calientes los alimentos.*
Ap. de remise en température *Aplicación: Retermaliza alimentos fríos. Mantiene calientes los alimentos.*

	INDUCTION 3D	RETRO	CAYENNE	CAYENNE
	✓	✓	✓	✓
Warmer and rethermalizer <i>Calentadores y rethermalizadores</i> Ap. de remise à température et ap. de maintien à température				
Warmer only <i>Solo calentador</i> Chauffant seulement				
Power (W) <i>Potencia (W)</i> Puissance (W)	800	1.400	800	1.000
Direct contact heating system <i>Calentamiento a través de contacto directo</i> Système de chauffage par contact direct			✓	✓
Water <i>Agua</i> Eau		✓	✓	✓
Low water light <i>Luz indicadora nivel de agua bajo</i> Contrôle du niveau d'eau par voyant lumineux			✓	✓
Induction <i>Inducción</i> Induction	✓			
Capacity (L) <i>Capacidad (L)</i> Capacité (L)	6,6 - 10,4	6,6 - 10,4	6,6 - 10,4	20
Temperature control <i>Control de temperatura</i> Contrôle de température	✓	✓	✓	✓

Warmers *Application: Hold Heated Food.*
Calentadores *Aplicación: Mantiene calientes los alimentos.*
Chaud *Application: Tenir les aliments chauffés.*

	SOUP KETTLE <i>OLLA ELÉCTRICA / MARMITE CHAUD</i>	BAIN MARIE <i>BAÑO MARÍA / BAIN MARIE</i>	CHAFING DISH
	✓	✓	✓
Power (W) <i>Potencia (W)</i> Puissance (W)	400	1200	0
Water <i>Agua</i> Eau	✓	✓	✓
Capacity (L) <i>Capacidad (L)</i> Capacité (L)	10	20	9
Temperature control <i>Control de temperatura</i> Contrôle de température	✓	✓	

12.4 Rethermalizers

Retermalizadores
Appareil de remise en température

INDUCTION 3D

RETHERMALIZER

MIRAGE®



Low power, 3D induction, without the need to use water.
Rapid heating time (50-60 min).
Food does not need to be pre-heated.
Directly from the freezer to the Rethermalizer.
Pre-selection menu and precise temperature regulator.

Inducción 3D de bajo consumo, sin necesidad de utilizar agua.
Tiempo de rethermalización rápido (50-60 min).
Los alimentos no necesitan ser precalentados.
Directamente del congelador al Retermalizador.
Menú de preselección y regulador de temperatura preciso.

Induction 3D basse consommation, sans nécessité d'utiliser de l'eau.
Temps de rethermalisation rapide (50-60 min).
Les aliments n'ont pas besoin d'être préchauffés.
Directement du congélateur au rethermalisateur.
Menu de présélection et régulateur de température précis.

Rethermalizers 124

Retermalizadores
Appareil de remise en température

747-7411 Mirage® Induction Rethermalizers
Retermalizador de inducción Mirage®
Appareil de remise en température à induction Mirage®

CE



800 W
3,5 A
50/60Hz



REF	L	Ø cm	H cm	Prof. cm	Volt. CA / AC	Plug Ench.	☐
7470210	6,6	30,3	34,2	17,6	230	EU	1
7470240	6,6	30,3	34,2	17,6	230	EU	1
7470310	6,6	30,3	34,2	17,6	230	UK	1
7470340	6,6	30,3	34,2	17,6	230	UK	1
74110210	10,4	35,3	34,2	17,6	230	EU	1
74110240	10,4	35,3	34,2	17,6	230	EU	1
74110310	10,4	35,3	34,2	17,6	230	UK	1
74110340	10,4	35,3	34,2	17,6	230	UK	1

Natural / Naturel
 Red / Rojo / Rouge



88184 Induction ready inserts for Mirage® 3D Induction Rethermalizers
Cubetas aptas para Retermalizadores Mirage® 3D
Conteneur pour Appareil de remise de température Mirage® 3D



REF	L	Fits opening Para abertura cm	Prof. cm	☐
88184	6,6	21,6	20,8	6
88204	10,4	26,7	20,8	6

747D-7411D Mirage® Drop-In Induction Rethermalizer
Retermalizador de inducción Mirage® encastrable
Appareil de remise en température à induction encastrable Mirage®

1,8 m

CE



800 W
3,5 A
50/60Hz



REF	L	Ø cm	H cm	Prof. cm	Volt. CA / AC	Plug Ench.	☐
74702D	6,6	30,3	31,3	17,6	230	EU	1
74703D	6,6	30,3	31,3	17,6	230	UK	1
741102D	10,4	35,3	31,3	17,6	230	EU	1
741103D	10,4	35,3	31,3	17,6	230	UK	1

Drop-In / Encast.



47488 Lid with hinge
Tapa con visagra y orificio
Couvercle

CE



REF	For / Para	Ø cm	☐
47488	78184 / 88184	24,0	6
47490	78204 / 88204	28,7	6

12.4 Rethermalizers

Retermalizadores
Appareil de remise en température

Retro



Retro Rethermalizer unit heats products with water, like any bain marie. Heats food from a chilled state to a temperature in less than 90 minutes.

Ceramic base element ensures a fast start-up and consistent performance. Heavy duty exterior body ensures the unit remains cool to the touch while operating. Ladles sold separately.

El Retermalizador Retro calienta los productos con agua, como cualquier baño maría. Calienta la comida fría hasta una temperatura deseada en menos de 90 minutos.

El elemento de base cerámica garantiza un arranque rápido y un rendimiento uniforme. El cuerpo exterior no se calienta durante el uso del Retermalizador. Los cacillos se venden por separado.

L'unité de remise à la température Retro chauffe les produits avec de l'eau, comme tout bain marie. Chauffe les aliments d'un état réfrigéré à une température en moins de 90 minutes.

L'élément de base en céramique garantit un démarrage rapide et une performance homogène. L'extérieur ultra-robuste garantit que l'appareil reste frais au toucher tout en fonctionnant.

Rethermalizers 124

Retermalizadores
Appareil de remise en température

7217 Retro Stock Pot Kettle Rethermalizers
Retermalizadores Estilo Retro
Marmite de remise en température Rétro

CE

Retro

Natural
Naturel

Red
Rojo
Rouge

Blanc cassé
Blanco perla
Pearl white

Black
Negro
Noir



REF	L	CA/AC Volt.	W	A	Plug Ench.	Hz	☐
7217810	6,6	230	1400	6,1	EU	50/60	1
7217910	6,6	230	1400	6,1	UK	50/60	1
7217850	6,6	230	1400	6,1	EU	50/60	1
7217950	6,6	230	1400	6,1	UK	50/60	1
7217855	6,6	230	1400	6,1	EU	50/60	1
7217955	6,6	230	1400	6,1	UK	50/60	1
7217860	6,6	230	1400	6,1	EU	50/60	1
7217960	6,6	230	1400	6,1	UK	50/60	1
7217310	10,4	230	1400	6,1	EU	50/60	1
7217410	10,4	230	1400	6,1	UK	50/60	1
7217350	10,4	230	1400	6,1	EU	50/60	1
7217450	10,4	230	1400	6,1	UK	50/60	1
7217355	10,4	230	1400	6,1	EU	50/60	1
7217455	10,4	230	1400	6,1	UK	50/60	1
7217360	10,4	230	1400	6,1	EU	50/60	1
7217460	10,4	230	1400	6,1	UK	50/60	1

4980 One-Piece Ergo Grip™ Ladles with Kool-Touch® Handles
Cacillos ErgoGrip™ de una sola pieza Kool-Touch®
Louches Ergo Grip™ monobloc avec manche Kool-Touch®



REF	ml	Bowl / Bol Ø cm	Total cm	*cm	☐
4980422	118,3	7,9	33,3	27,6	6
4980622	177,4	8,6	33,6	27,6	6

*Length from bowl bottom to bend in handle
*Largo desde el fondo del porcionador hasta el gancho del asa
*Longueur du fond du bol à la courbure dans le manche

One-piece construction.
Stainless steel.
Plastic-coated handles are heat resistant to 82° C.

Construcción de una sola pieza en acero inoxidable.
Asas revestidas de plástico que resisten el calor hasta 82 °C.

Construction monobloc Inox.
Manches plastifiés résistant à 82 °C.

46527 Lid with hinge
Tapa con visagra y orificio
Couvercle

CE

Retro



REF	Ø cm	☐
46527	24	6

Bain Maries
Baño maría
Bain-marie

Thermoset Fiber-Reinforced Resin Well
Selfinsulating. Maximum energy efficiency. Easy to clean.

Cuerpo de resina reforzada con fibra termofijada auto aislante. Máxima eficiencia energética. Fácil de limpiar.

Compartiment en résine thermodurcie renforcée Isotherme. Rendement énergétique maximal. Nettoyage facile.

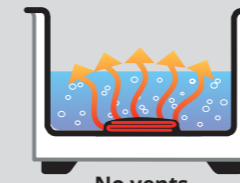

No vents
Sin ventilaciones
Sans ventilation

High efficiency
Alta eficiencia
Très écoénergétique

DIRECT CONTACT HEATING SYSTEM - The ultimate in performance and efficiency
The heating element is in direct contact with the water for the most efficient heat transfer possible. This is coupled with Vollrath's exclusive Thermoset fiber-reinforced resin well, which provides superior insulation for maximum energy efficiency. So much heat is saved that there is no need for vents.

SISTEMA DE CALENTAMIENTO DE CONTACTO DIRECTO - Lo último en rendimiento y eficiencia
La resistencia está en contacto directo con el agua, transfiriendo el calor de una forma más eficiente. Esto se combina con el exclusivo cuerpo de resina reforzada, permitiendo un máximo aislamiento y máxima eficiencia energética. No necesita ventilación.

SYSTÈME DE CHAUFFAGE PAR CONTACT DIRECT - Performance et efficacité maximales
L'élément chauffant est en contact direct avec l'eau afin de permettre un transfert de la chaleur le plus efficace possible. De plus, le compartiment exclusif de Vollrath en résine thermodurcie renforcée offre une insolation supérieure rendant possible un rendement écoénergétique maximum. La conservation de chaleur est telle qu'il est inutile d'utiliser des évents.

Upper rim designed to prevent drips and to drain off the moisture.
Borde superior diseñado para evitar goteos y drenar la humedad.
Bordure supérieure conçue pour éviter l'égouttement et drainer l'humidité.

Dome Heater. Uses up to 25% less energy. Non-stick surface prevents scale build-up for easy cleaning and longer operating life. Cast-in heating element for longer service life and greater energy transfer. Concentrates energy into the well – producing steam quickly.

Calentador con cúpula usa hasta un 25% menos de energía. La superficie antiadherente evita la acumulación de comida, facilitando la limpieza y prolongando la vida útil. Resistencia incrustada que alarga la vida útil y ayuda a difundir mejor el calor. Concentra la energía dentro del recipiente; produce vapor rápidamente.

Élément chauffant avec dôme qui utilise jusqu'à 25 % d'énergie en moins. La surface anti-adhésive empêche l'accumulation de dépôts calcaires pour faciliter le nettoyage et prolonger la durée de vie. Élément chauffant moulé pour prolonger la durée de service et augmenter le transfert d'énergie. Concentre l'énergie dans le compartiment; produit rapidement de la vapeur.

Capillary tube thermostat, provides energy only when it is required to reach the desired temperature.

Termostato de tubo capilar, suministra energía solamente cuando es necesario, para alcanzar la temperatura deseada.

Thermostat à tube capillaire, il fournit de l'énergie que lorsque c'est nécessaire pour atteindre la température souhaitée.

Non-skid Feet
Pies antideslizantes
Pieds antidérapants

Increased Water Capacity. Reduce labor costs. Improve food quality by maintaining maximum moist heat.

Mayor capacidad de agua reducen los costes de mano de obra. Mejoran la calidad de la comida manteniendo el máximo calor húmedo.

Capacité d'eau supérieure ayant pour conséquence une diminution des frais de main-d'oeuvre. Amélioration de la qualité des aliments grâce au maintien d'un maximal de chaleur humide.

Cooler Exterior Concentrates heat inside the well, not to the outside surface and rim.

Exterior más fresco concentra el calor dentro del receptáculo, no en la superficie exterior ni en el reborde.

Extérieur plus frais qui concentre la chaleur à l'intérieur du compartiment et non sur la surface extérieure ou sur le rebord.

Low positioning of electrical cord outlet adapts to the location of the power socket for safe installation. Allows the location to be controlled 360°. Standard cable length of 183 cm.

Cable eléctrico con salida inferior se adapta a la ubicación de la toma de corriente para una instalación segura. Permite controlar la ubicación en 360°. Largo estándar del cable de 183 cm.

Câble d'alimentation muni d'une sortie située à la base. S'adapte à la prise de courant pour une installation sûre. Permet le positionnement des commandes à 360 degrés. Câble d'une longueur standard de 183 cm.



EQUIPMENT
MAQUINARIA
EQUIPEMENT

EQUIPMENT
MAQUINARIA
EQUIPEMENT

124 Bainmarie

Baños maría
Bain-marie



CAYENNE®

72522 Cayenne® Heat'N'Serve Rethermalizer
Olla Retermalizadora Cayenne® Heat'N'Serve
Ap. de remise en temp. Heat 'N Serve ronds Cayenne®

800 W
3,5 A
230 V



HS-11

REF	cm (Ø x H)	L	V	W	Plug Ench.	⊠
72522	32,0 x 24,5	10,4	230	800	EU	1

With inset, hinged cover
Con recipiente interior y tapa con visagra
Avec conteneur et couvercle

47488 / 47490 Lid with hinge
Tapa con visagra y orificio
Couvercle

CE



78204 Insert container
Recipiente interior
Conteneur pour appareil de remise en température Heat 'N Serve ronds Cayenne®

CE



REF	For / Para	Ø cm	AL cm	L	⊠
78204	72522	28,7	20,8	10,4	6

*Not induction-ready insert
*Cubeta no apta para Inducción
*Conteneur non Induction

REF	For / Para	Ø cm	⊠
47488	78184 / 88184	24,0	6
47490	78204 / 88204	28,7	6

Bainmarie 124

Baños maría
Bain-marie

72630 Rethermalizer Cayenne® Heat'N'Serve
72550 full size
Retermalizador Cayenne® Heat'N'Serve
1/1 Gastronorm
Appareils de remise en temp. Cayenne®
Heat'N Serve 1/1 Gastronorme

1.000 W
4,3 A
230 V
50/60 Hz



REF	Well depth / Profundidad cm	Plug / Ench.	⊠
72630	16,8	EU	1
72550	16,8	UK	1

Thermoset fiber reinforced well — self-insulating with maximum energy efficiency. Capillary Tube Thermostat Control

Recipiente de resina reforzada con fibra termofijada aislante. Máxima eficiencia energética. Control de termostato

Compartment en résine thermodurcie renforcée - isotherme pour un rendement énergétique maximal. Thermostat à tube capillaire



P15020 Bain-marie 1/1 Gastronorm / Bain-marie
1/1 Gastronorm with drain valve
Baño maría 1/1 Gastronorm / Baño maría
1/1 Gastronorm con grifo drenaje
Bain-marie 1/1 Gastronorme / Bain-marie
1/1 Gastronorm avec robinet de drainage

CE

+30 °C
+90 °C

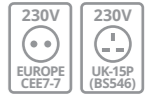

REF	TIPO / TYPE	V	W	Hz	⊠
P15020	A	230	1.200	50/60	1

Without bags
Sin cubetas
Sans bacs

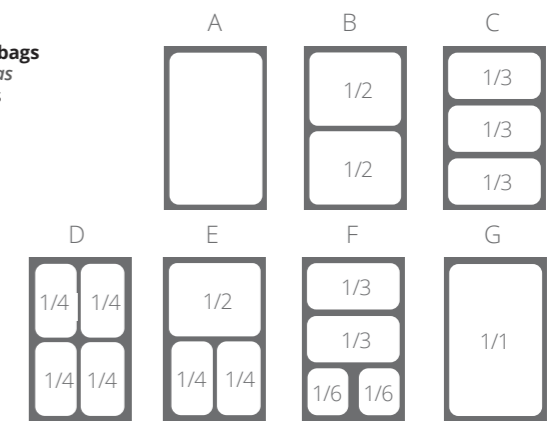

Max H 100 mm

124 Bainmarie

Baños maría
Bain-marie

P688130 Vacuum sealer
Envasadora al vacío
Machine sous vide

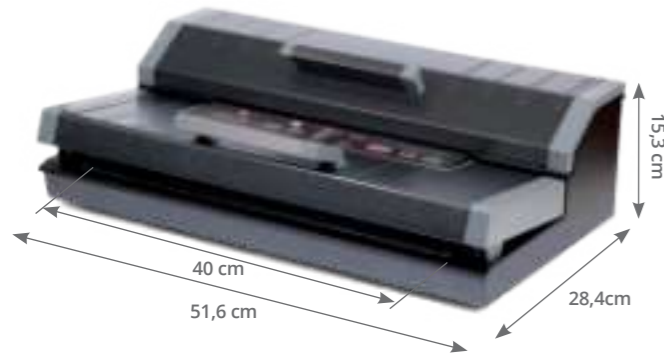

REF	V	W	Hz	Kg	☐
P688130	230	200	50	7,5	1

Compact vacuum sealer.

Food sealed under vacuum can be preserved for much longer periods.

With the absence of oxygen, micro-organisms do not develop.

You can save time by cooking more than you need and keeping the excess in perfect condition for later use.

- 400mm sealing width
- Vacuum function for table pans
- Marinated / Liquids function
- Partial vacuum function
- 20 L/min vacuum pump
- Possibility of using as bag sealer only

Envasadora al vacío compacta.

Los tiempos de conservación de los alimentos al vacío son mucho mayores.

Los microorganismos no se desarrollan ante la ausencia de oxígeno.

Puede ahorrar tiempo al cocinar en exceso y poder conservarlo en perfectas condiciones para un posterior uso.

- 400mm de banda de soldadura
- Función de vacío para cubetas
- Función marinado / Líquidos
- Función vacío parcial
- 20 L/min bomba vacío
- Posibilidad de usar solo como selladora de bolsas

Machine sous vide compacte.

Les durées de conservation des aliments sous vide sont largement supérieures.

Les microorganismes ne se développent pas en raison de l'absence d'oxygène.

Vous pouvez gagner du temps en cuisinant en grande quantité que vous pouvez conserver dans de parfaites conditions pour une consommation ultérieure.

- Bande de soudure de 400 mm
- Fonction sous vide pour bacs
- Fonction marinade / Liquides
- Fonction sous vide partiel
- 20 L/min pompe à vide
- Peut s'utiliser comme scelleuse de sachets

P688133 Vacuum bags
P688134 Bolsas vacío
Sachets sous vide



REF	L m	W cm	☐
P688133	6	30	1
P688134	6	40	1

P910008 Soup kettle
Olla eléctrica para buffet
Marmite buffet chaud



External aluminium body with epoxy coating.

Cuerpo de aluminio con baño epoxy.

Corps en aluminium laque epoxy.



REF	cm	L	☐
P910008	34,5 x 36	10,0	1

Thermostat to regulate the temperature. Resistance 400 W, 1,9 amperes, 230 V single phase, 50/60 Hz. St/Steel lid. Inside pool St/Steel, 10 lts. capacity.

Termostato regulador de temperatura. Resistencia 400 W, 1,9 amperios, 230 V monofase, 50/60 Hz. Tapa de acero inox. Cuba interior de acero inox. con capacidad para 10 litros.

Thermostat pour le réglage de la température. Résistance 400 W, 1,9 ampères, 230 V monophasée, 50/60 Hz. Couverture en acier inox. Cuve intérieure en acier inox. capacité 10 lts.

Heating lamps 124

Lámparas mantenedoras
Lampe chauffante

P15029 Heat shade with lamp
P15030 Lámpara mantenedora de comida caliente
Abat - jour pour lampe chauffante infra-rouge



REF	Ø cm	V	W	Hz	☐
P15029	23	230	250	50/60	1
P15030	23	230	250	50/60	1

Rise&fall cable
Cable extensible
Cable extensible

Delivered with red bulb
Se entrega con bombilla roja
Livraison avec ampoule rouge

Aluminium or copper. With on/off switch. It gives instant direct heat. Provides a penetrating heat without congealing surfaces, gravies, etc. Simple to install. Delivered with bulb (250 W max). Cable with rise and fall mechanism (max. 140 cm).

Aluminio o cobre. Con interruptor. Se pone en funcionamiento rápidamente y proporciona un calor penetrante sin solidificar la superficie de las salsas. Fácil de instalar. Se entrega con lámpara (250 W max). Versión con cable de mecanismo extensible (máx. 140 cm).

Aluminium ou cuivre. Avec interrupteur. Mise en service rapide. Chaleur pénétrante sans coaguler la surface des sauces, etc. Facile à installer. Livraison avec ampoule (250 W max). Avec cable extensible (max. 140 cm).

P688265 Heat shade
Lámpara mantenedora de comida caliente
Abat - jour pour lampe chauffante

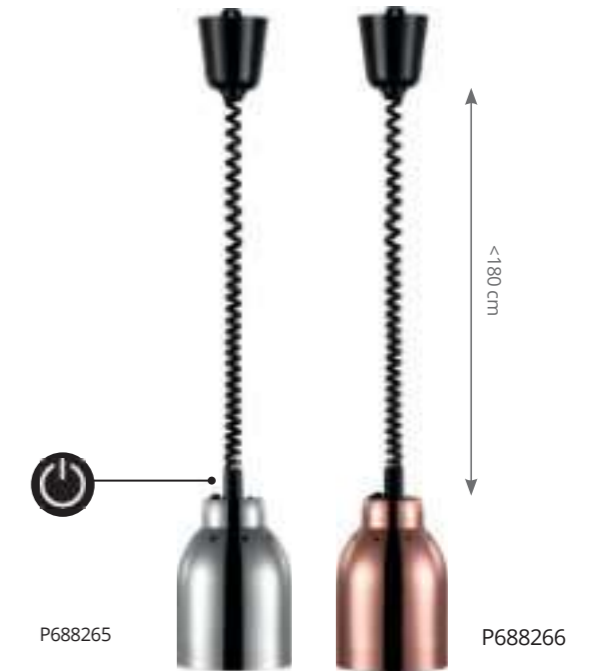

REF	Ø cm	V	W	Hz	☐	
P688265	St/Steel / Inox	16	230	250	50/60	1
P688266	Copper / Cobre / Cuivre	16	230	250	50/60	1

Bulb not included.
Bombilla no incluida.
Ampoule non comprise.

Cable with rise and fall mechanism upto 180 cm.
Cable extensible hasta 180 cm.
Avec cable extensible jusqu'à 180 cm.

P688045 Heat shade
Lámpara mantenedora de comida caliente
Abat - jour pour lampe chauffante



Iron chrome plated with on/off switch. Delivered without bulb.
Cable with rise and fall mechanism upto 180 cm.

Acero acabado brillante con interruptor. Se entrega sin bombilla.
Cable extensible hasta 180 cm.

Acier fini brillant avec interrupteur. Livraison sans ampoule. Avec cable extensible jusqu'à 180 cm.



REF	Ø cm	V	W	Hz	☐
P688045	23	230	250	50/60	4

124 Heating lamps

Lámparas mantenedoras
Lampe chauffante

P688250 Heat shade
Lámpara mantenedora de comida caliente
Abat - jour pour lampe chauffante



Bulb not included.
Bombilla no incluida.
Ampoule non comprise.

REF		Ø cm	V	W	Hz	☐
P688250	St/Steel / Inox	24	230	250	50/60	1
P688251	Copper / Cobre / Cuivre	24	230	250	50/60	1

P508015 Heat shade with table support
Lámpara mantenimiento comida caliente
con soporte mesa
Lampe chauffante avec support



REF	W x D x H cm	V	W	Hz	☐
P508015	22 x 22 x 65	230	250	50/60	1

Appliance adapted to heat and keep warm snacks and ready meals.
Structure is composed by an infrared lamp with a stainless steel base. Delivered with red bulb (250 W).

Lámpara adaptada para mantener caliente todos platos. Estructura compuesta de lámpara infrarrojos con base en acero inoxidable. Bombilla roja (250 W) incluida en el precio.

Lampe adaptée pour maintenir au chaud tous vos plats. Structure composée par lampe infrarouge avec base en inoxydable. Livrée avec ampoule rouge (250 W).

P688260 Heat shade with marble
Lámpara mantenedora de comida caliente con mármol
Abat - jour pour lampe chauffante avec marbre



Bulb not included.
Bombilla no incluida.
Ampoule non comprise.

REF		cm	V	W	Hz	☐
P688260	St/Steel / Inox	50 x 45	70	230	250	50/60
P688261	Copper / Cobre / Cuivre	50 x 45	70	230	250	50/60

P15033 Bulb only
P15034 Bombilla
Ampoule seule



REF	Color / Colour / Couleur	W	☐
P15033	red / rojo / rouge	175	1
P710205	red / rojo / rouge	250	1
P15034	white / blanco / blanc	175	1
P710206	white / blanco / blanc	250	1

Heating lamps 124

Lámparas mantenedoras
Lampe chauffante

Contoured carving station
Estación buffet trinchante
Station de découpage concave

Attractive Carving Station with lamps for additional heat while serving.
On/off lighted switch on base.

Atractiva estación trinchante (para carnes) con lámparas calentadoras. Interruptor iluminado de encendido/apagado en la base.

Station de découpage attrayante disposant de lampes pour plus de chaleur durant le service. Interrupteur lumineux de marche/arrêt sur la base.

2 x 175 W (Ref. P15033 / P15034)

Dual heat lamps.
Lámparas calentadoras dobles.
Deux lampes chauffantes

Spun aluminum shades for heat dissipation
Pantallas de aluminio para disipar el calor
Abat-jour en aluminium repoussé pour dissiper la chaleur

Clear tempered glass customer breath guard
Protección contra aliento con vidrio templado transparente
Pare-haleine en verre trempé transparent

Heavy-duty steel frame, chrome-plated
Marco de acero cromado altamente resistente
Cadre en acier chromé extra-robuste

Rubber feet provide stability and protect tabletop
Pies antideslizantes que ofrecen una mayor estabilidad
Les pieds en caoutchouc stabilisent et protègent la table



Stylish solid surface base & top
Base y parte superior elegantes con superficie lisa
Surface pleine esthétique (base et dessus)

Knife-friendly, dishwasher safe NSF Certified cutting board included
Incluye tabla de corte, apta para Certificación NSF
Planche à découper certifiée NSF incluse; apte pour le lave-vaisselle

Recessed base channels liquids into removable drip pan
La base empotrada canaliza los líquidos hacia una cubeta para goteo retirable
La base renforcée conduit les liquides dans un plateau ramasse-gouttes

4667 Contoured Carving Station
Estación buffet trinchante
Station de découpage concave



Cord
Cable
Cordon
L: 1,8 m.



REF	W x D x H cm	CA/AC Volt.	Plug Ench.	Hz	☐
46671	61 x 55,9 x 68,6	230	EU	50/60	1
46672	61 x 55,9 x 68,6	230	UK	50/60	1

Infrared bulb
Bombilla de infrarrojos
Ampoule infrarouge

2 Infrared bulb included
Incluye 2 bombillas de infrarrojos
Inclus 2 ampoules infrarouges

P15033

12.4 Warming equipment

Mantenedores de temperatura
Maintenance de température

P15073 Heating plate
P15074 Placa caliente
Plaque chauffante



18/10 St/Steel. Adjustable thermostat up to 75 °C. With on / off switch and indicator light.

Fabricada en acero inoxidable 18/10. Termostato regulable hasta 75 °C. Con interruptor central y piloto de control.

Habillage en inox 18/10. Thermostat réglable jusqu'à 75 °C. Interrupteur central et voyant de contrôle.

REF	cm	V	W	Hz	☐
P15073	60 x 40,0	230	600	50/60	1
P15074	53 x 32,5	230	600	50/60	1

P15096 Chocolate fountain
P15097 Fuente Fondue chocolate
Fontaine à chocolat



REF	ml	Levels / Niveles / Niveaux	V	Hz	Ø cm	H cm	W	☐
P15096	700	3	230	50	21	38,0	250	1
P15097	1200	4	230	50	23	45,0	250	1

46110 Universal electric chafing heater
Elemento eléctrico universal para chafing dish
Résistance électrique pour chafers



Sized to fit standard fuel opening.
Dimensiones compatibles con el orificio para combustible estándar.
Dimensions compatibles avec l'orifice pour combustible standard.

REF	For Para	V	W	A	Hz	Plug Ench.	☐
46110	EU	230	120/230	1.0	50/60	EU	1
46115	UK	230	120/230	1.0	50/60	UK	1

P950000 Electric heating unit for chafing dish
Elemento eléctrico para chafing dish
Corps de chauffe pour chafing dish



REF	W	Hz	☐
P950000	240	50/60	1

P15010 Chocolate warmer
Baño maría chocolate
Chauffe-chocolat



REF	Units / Unidades / Unités	Lts	V	W	Hz	☐
P15010	1	3,50	230	250	50/60	1

Hotbanquet trolleys 124

Armarios calientes
Armoires chaudes

New range of heated trolleys for banquets and other catering events, a range that enables you to take the kitchen to customer, guaranteeing maximum quality and the delivery of dishes at temperatures above 65 °C.

Nueva gama de carros calientes para banquetes y catering, que le permitirán acercarse a la cocina allí donde esté el cliente, asegurando la máxima calidad y la entrega de los platos por encima de los 65 °C.

Nouvelle gamme de chariots chauds pour banquets et service traiteur (catering), pour vous permettre de rapprocher la cuisine du lieu où se trouve le client, en garantissant la qualité maximale et la livraison des plats au-dessus de 65 °C.

EVEN CIRCULATION OF HOT AIR
UNIFORMIDAD DE CIRCULACIÓN DEL AIRE CALIENTE
UNIFORMITÉ CIRCULATION AIR CHAUD

The circulation of air is even and constant thanks to a unique system that makes it impossible for the containers to touch the cabinet base or sides.

Circulación uniforme y constante del aire gracias a un sistema único que imposibilita el contacto de las cubetas con el fondo o las paredes.

La circulation d'air chaud est uniforme et constant grâce à un système unique qui empêche que les bacs touchent le fond ou les parois.



Rockwool insulation
Aislamiento en lana de roca
Isolation en laine de roche

+LONG LASTING
Thermal insulation provided by rockwool preventing deformation through heat and lengthening the useful life of the cabinet.

+ENERGY SAVING
Thanks to the extraordinary thermal insulation system, the desired temperature is achieved more quickly and the heat is conserved for longer periods.

+HYGIENE
With the exclusive system of monoblock guides (without welds) cleanliness inside is grater, easier and faster.

+ DURADERO
Aislamiento térmico en lana de roca evitando la deformación con el calor y ampliando la vida útil del armario.

+ AHORRO ENERGÉTICO
Gracias al extraordinario sistema de aislamiento, se consigue el grado de temperatura deseado, con mayor rapidez y permite conservar el calor durante un período de tiempo más prolongado.

+ HIGIÉNICO
Con el sistema de guías monobloc (sin soldaduras) la limpieza interior es mayor, más fácil y rápida.

+DURABLE
Isolation thermique en laine de roca pour éviter la déformation par la chaleur et augmenter la vie utile de l'armoire.

+HYGIÉNIQUE
Grâce au système exclusif de glissières monobloc (sans soudures) le nettoyage intérieur est plus parfait, plus aisé et plus rapide.

+ÉCONOMIE D'ÉNERGIE
Grâce à l'extraordinaire système d'isolation thermique, la température souhaitée s'obtient plus rapidement et cela permet de conserver la chaleur pendant une plus longue période de temps.

124 Hotbanquet trolleys

Armarios calientes
Armoires chaudes

2

CAPACITY / CAPACIDAD / CAPACITÉ

Monoblock guides (without welds) for St/Steel trays and Gastronorm containers 2/1 and 1/1.

Guías monobloc (sin soldaduras) para rejillas acero inoxidable y cubetas Gastronorm 2/1 y 1/1.

Glissières monobloc (sans soudures) pour grilles acier inoxydable et bacs Gastronorm 2/1 et 1/1.

EASY HANDLING / FÁCIL MANEJO / MANIPULATION AISÉE

Back side handles.
Rotating wheels 360°.
Front wheels with brakes

Asas posteriores.
Ruedas pivotantes & 360°.
Dos con freno

Poignées postérieures.
Roues pivotantes 360°.
Roues avant avec freins

3

HEAT BLOCK / BLOQUE CALÓRICO / BLOC CHAUFFANT

Extractable without the need of tools. Thermostat for regulation of temperature 0 °C to 90 °C. Provided with humidification container.

Extraíble sin necesidad de herramientas.
Termostato regulador temperatura 0 °C a 90 °C. Recipiente humidificador integrado.

Amovible sans besoin d'outils. Thermostat régulateur de température 0 °C - 90 °C. Bac humidification intégré.

P810

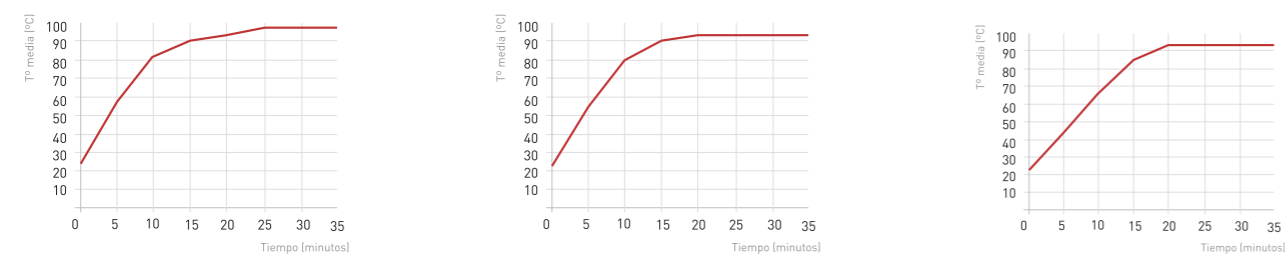

REF	Rails	Dimensions / Medidas	Guías / Glissières	Capacity / Capacidad / Capacité	W	V	Hz	⊠
P81000		GN 2/1		10 GN 2/1 - 20 GN 1/1	3.000	230 V II	50/60	1
P81010		GN 2/1		20 GN 2/1 - 40 GN 1/1	3.000	230 V II	50/60	1
P81020		GN 2/1		40 GN 2/1 - 80 GN 1/1	4.000	230 V II	50/60	1



Hotbanquet trolleys 124

Armarios calientes
Armoires chaudes

P15027 / P15028 Hot cupboards

Calentador de platos
Chauffe - assiettes



+35 °C
+85 °C



Inner sizes / Medidas interiores / Mesures interieures
41 x 38 x 66,5 cm



Inner sizes / Medidas interiores / Mesures interieures
70 x 35 x 80 cm

REF	Capacity plates / Capacidad platos / Capacité assiettes	V	W	Hz	⊠
P15027	60	230	750	50/60	1
P15028	120	230	1.250	50/60	1

Hot cupboards. St/Steel, wholly insulated. With thermostat and switch with indicator light, removable and adjustable shelves. Door with heavy duty hinges. Diameter max. plates 32 cm.

Calentadores de platos. Acero inoxidable, doble pared, completamente aislado térmicamente. Con termostato e interruptor con piloto de control. Estantes interiores regulables y extraíbles. Puertas con bisagras muy reforzadas. Diámetro máximo de los platos de 32 cm.

Chauffe-assiettes. Inox, double paroi, entièrement calorifugée, avec thermostat et interrupteur avec voyant de contrôle, étagères ajustables et amovibles. Porte avec charnières très résistantes. Diamètre max. assiettes 32 cm.

40862 Cubed-glass refrigerated display case

Vitrina de vidrio sobre encimera
Vitrine en verre sur plan de travail.



NEW!



REF	W x D x H cm	V	A	Hz	Plug Ench.	⊠
40862	89,9 x 54 x 93,98	120	3,9	60	USA	1
40863	120 x 54 x 94	120	24,1	60	USA	1

- Digitally controlled thermostat on heated units for precise and consistent settings.
- Dual fans circulate air through unit to ensure even temperature control.
- Double-glaze front for added strength and insulation.

- Termostato con control digital par ajustes precisos y consistentes.
- Los ventiladores dobles permiten la circulación del aire por toda la unidad para garantizar un control uniforme de la temperatura.
- Frente de doble acristalamiento para mayor resistencia y aislamiento.

- Thermostat avec commande numérique pour des réglages précis et cohérents.
- Les doubles ventilateurs permettent la circulation de l'air dans toute l'unité pour assurer un contrôle uniforme de la température.
- Double vitrage pour plus de résistance et d'isolation.

Ice-cream and beverage solutions
Soluciones para la heladería
Solutions pour glaciers

Softice-cream & frozen yogurt

Helado soft y yogur helado
Glace à l'italienne



Stoelting offers commercial-grade gravity and pressure-fed Soft Serve Ice Cream, and Frozen Yogurt Machines in floor and countertop models. Whether you're looking for single flavor, twin twist, or double cylinder designs, we have the ideal equipment for your industry.

Stoelting ofrece la posibilidad de comercializar helados suaves a través de una alimentación por gravedad y presión. Ofrece máquinas de yogur helado de sobremesa y para ubicar en suelo. Dispone de diseños de un solo sabor, doble tirador o doble cilindro; en definitiva, equipos ideales para la industria y servicio de helados y postres fríos.

Stoelting offre la possibilità di commercializzare le gelaterie dolci attraverso un'alimentazione a gravità e pressione. Il propone delle macchine a yogurt glacé de table et à placer sur le sol. Il dispose de conceptions à une seule saveur, d'une poignée ou d'un double cylindre; en bref, un équipement idéal pour l'industrie et un service de crème glacée et de desserts froids.

Series Serie Série	111	131	231	411	431	144	421
Power supply Alimentación Alimentation	Gravity Gravedad Gravité	Gravity Gravedad Gravité	Gravity Gravedad Gravité	Pump Bomba Pompe	Pump Bomba Pompe	Gravity Gravedad Gravité	Pump Bomba Pompe
Flavours Sabores Parfums	1	2+1	2+1	1	2+1	Soft + Milshake	2
Type Tipo Type	Countertop Sobremesa De comptoir	Countertop Sobremesa De comptoir	Floor Suelo Au sol	Floor Suelo Au sol	Floor Suelo Au sol	Countertop Sobremesa De comptoir	Floor Suelo Au sol
CONES CAPACITY CAPACIDAD CONOS CAPACITÉ CONES							
Model Modelo Model	E						
	150-180	290-310	-	-	-		
Model Modelo Model	F / SF					220-240	
	275-300	400-420	400-420	-	-		
Model Modelo Model	O						
	380-420	-	780-820	-	675-700		675-700
Model Modelo Model	U						
	-	-	-	640-660	1.350-1.400		1.350-1.400

***The production capacity may vary depending on the ambient temperature**
**La capacidad de producción puede variar en función de la temperatura ambiental utilizada*
**La capacité de production peut varier en fonction de la température ambiante au moment de l'utilisation*

Shake & Smoothie freezers

Batidos & smoothies helados
Frappés & smoothies glacés



Stoelting's Shake & Smoothie Freezers feature a compact design with high-capacity output. Our equipment will handle high-demand rush hour requirements quietly and efficiently, while giving your profits a boost. Ideally suited for high volume commercial operations, such as fast food locations, drivings, theme parks, institutions, and recreations facilities. Perfect for thin or thick milshakes, frozen beverages, smoothies and frozen cocktails.

Los congeladores Shake & Smoothie de Stoelting presentan un diseño compacto con salida de alta capacidad. Nuestros equipos controlan de manera silenciosa y eficiente los picos de alta demanda, lo que permite ahorrar a la hora que identificar los momentos de más demanda. Ideal para operaciones comerciales de gran volumen en servicios, tales como cadenas de comida rápida, autocines, parques temáticos, instituciones e instalaciones recreativas. Perfecto para batidos finos o espesos, bebidas congeladas, batidos y cócteles congelados.

Les congélateurs Shake & Smoothie de Stoelting présentent un design compact avec une sortie de haute qualité. Nos équipes contrôlent silencieusement et efficacement les pics de demande, ce qui permet d'économiser en identifiant les moments les plus demandés. Idéal pour les opérations commerciales de grands volumes dans les services tels que les chaînes de restauration rapide, les cinémas automatiques, les parcs à thème, les institutions et les installations de loisirs. Parfait pour les smoothies fins ou épais, les boissons surgelées et les cocktails surgelés.

Series Serie Série	112	122	0212	SU412
Power supply Alimentación Alimentation	Gravity Gravedad Gravité	Gravity Gravedad Gravité	Gravity Gravedad Gravité	Gravity Gravedad Gravité
Flavours Sabores Parfums	1	2	1	1
Type Tipo Type	Countertop Sobremesa De comptoir	Countertop Sobremesa De comptoir	Floor Suelo Au sol	Floor Suelo Au sol
LITRES/HOUR LITROS/HORA LITRES/HOUR				
Model Modelo Model	E 45-68	90-136	-	-
Model Modelo Model	F 68-91	136-182	-	-
Model Modelo Model	SO -	-	98	-
Model Modelo Model	SU -	-	-	114

Frozen custard

Heladora custard
Glaces custard



Stoelting Frozen Custard Continuous Flow Freezer Machines have become the standard in the industry for quality and durability. With our Quick-Freeze Technology TM, the barrel freezes custard mix faster than any other machine. This minimizes the size of the ice crystals and ensures the smoothest, creamiest product.

Las máquinas congeladoras de flujo continuo se han convertido en el estándar en la industria de calidad y durabilidad. Con nuestra tecnología TM de congelación rápida, el barril congela la mezcla de crema pastelera de forma más rápida que cualquier otra máquina del mercado. Esto minimiza el tamaño de los cristales de hielo y asegura la consecución de un producto más suave y cremoso.

Les congélateurs à flux continu sont devenus la norme dans l'industrie en matière de qualité et de durabilité. Avec notre technologie de congélation rapide TM, le baril gèle le mélange de crème pâtissière plus rapidement que n'importe quelle autre machine sur le marché. Cela minimise la taille des cristaux de glace

Series Serie Série	101	202	303
Power supply Alimentación Alimentation	Gravity Gravedad Gravité	Gravity Gravedad Gravité	Gravity Gravedad Gravité
Flavours Sabores Parfums	1	2	3
Type Tipo Type	Countertop Sobremesa De comptoir	Floor Suelo Au sol	Floor Suelo Au sol
LITRES/HOUR LITROS/HORA LITRES/HOUR			
Model Modelo Model	CF 19-23	-	-
Model Modelo Model	M -	26-38	-
Model Modelo Model	CC -	42-53	42-53

Batch equipment

Mantecadoras
Turbines à glace



Rugged, reliable batch freezers for Premium Ice Cream, Gelato, Sherbet, Sorbet, and Water Ices. Our Batch Ice Cream Machines are simple to operate, easy to maintain, and built to assure perfect frozen desserts every time.

Congeladores por lotes resistentes y confiables para helados, gelato, sorbete y helados de agua premium. Nuestras máquinas de helados por lotes son fáciles de operar, fáciles de mantener y construidas para asegurar postres congelados perfectos en todo momento.

Congélateurs laitiers robustes et fiables pour la crème glacée, le sorbet et la crème glacée premium. Les machines à crème glacée par lots sont faciles à utiliser, faciles à entretenir et construites pour assurer des desserts congelés parfaits à tout moment.

Series Serie Série	VB1	VB9	VB25
Power supply Alimentación Alimentation	Gravity Gravedad Gravité	Gravity Gravedad Gravité	Gravity Gravedad Gravité
Type Tipo Type	Countertop Sobremesa De comptoir	Countertop Sobremesa De comptoir	Floor Suelo Au sol
CAPACITY L/H	9-10	9-10	20
Work Cycle (min) Ciclo trabajo (min) Cycle de travail (min)	14-18	14-18	12-15

Accesorios

Accesorios
Accessoires



Stoelting also offers accessories for our freezers, such as remote mix pumps to keep mix handling to a minimum, floor stands for converting counter top units to floor models, and mix-in blenders for marvelous mix-ins.

Stoelting también ofrece accesorios para nuestros congeladores, tales como bombas de mezcla remotas para mantener el manejo de mezclas al mínimo, soportes de suelo para convertir unidades de sobremesa en modelos de suelo y licuadoras mezclables para conseguir las mejores mezclas.

Stoelting offre également des accessoires pour nos congélateurs, tels que des pompes de mélange à distance pour maintenir la manipulation des mélanges au même niveau, des supports de sol pour convertir les unités de bureau en modèles de sol et des mixeurs pour obtenir de meilleurs résultats.

Series Serie Série	Mixing blender	CW5	CW2
Power supply Control Alimentation			
Model 521030	Foot Switch	-	-
Model 521035	Mounted Speed Control	-	-
Revolution per minut RPM Type	0-3000	-	-
Capacity Capacidad (L) Capacité	-	5	2

Cold & frozen Beverage dispensers

Bebidas frías y granizadoras
Boissons froides et granités

Stoelting manufactures a wide variety of commercial grade frozen beverage dispensing equipment. These compact and ultra high capacity units are perfect for a variety of high margin specialty drinks, smoothies, juices and frozen slush drinks including granitas, cappuccinos and frozen cocktails.

Stoelting fabrica una amplia variedad de equipos dispensadores de bebidas congeladas de grado comercial. Estas unidades compactas y de ultra alta capacidad son perfectas para una variedad de bebidas especiales de alto margen, batidos, zumos y bebidas congeladas, incluyendo granizados, capuchinos y cócteles congelados.

Stoelting fabrique une grande variété d'équipements de distribution de boissons congelées de qualité commerciale. Ces unités compactes et ultra-haute capacité sont parfaites pour une variété de boissons spéciales à marge élevée, de smoothies, de jus et de boissons surgelées, y compris les granités, les cappuccinos et les cocktails surgelés.

VCBF

Series Serie Série	118-37	D118-37	128	168
				
Power supply Alimentación Alimentation	Gravity Gravedad Gravité	Gravity Gravedad Gravité	Gravity Gravedad Gravité	Gravity Gravedad Gravité
Flavours Sabores Parfums	1	1	2	3
Type Tipo Type	Countertop Sobremesa De comptoir	Countertop Sobremesa De comptoir	Countertop Sobremesa De comptoir	Countertop Sobremesa De comptoir
Capacity per bowl Capacidad por bol (L) Capacité par bol	10	18,93	10	10
BTU/Hr	1100	8000	2550	3630

VCBA

118-37	A118	128	168	257
				
Gravity Gravedad Gravité	Gravity Gravedad Gravité	Gravity Gravedad Gravité	Gravity Gravedad Gravité	Gravity Gravedad Gravité
1	1	2	3	1
Countertop Sobremesa De comptoir	Countertop Sobremesa De comptoir	Countertop Sobremesa De comptoir	Countertop Sobremesa De comptoir	Floor Suelo Au sol
6	7,57	6	6	37,85
830	4500	1900	2550	2600

*Check with your salesteam for larger capacity machines.

*Consulta con tu comercial para máquinas de mayor capacidad

*Consultez votre commercial pour les machines de plus grande capacité

13 Melamine

Melamina y presentación
Melamine et présentation



-  **VOLCANO** 334
-  **STONEHENGE** 335
-  **SIENA** 336
-  **BIANCA** 337
-  **SAHARA** 338
-  **MOON** 339
-  **BUFFETDISPLAY** 340
-  **HIDRAULICA** 341
-  **WOOD** 342

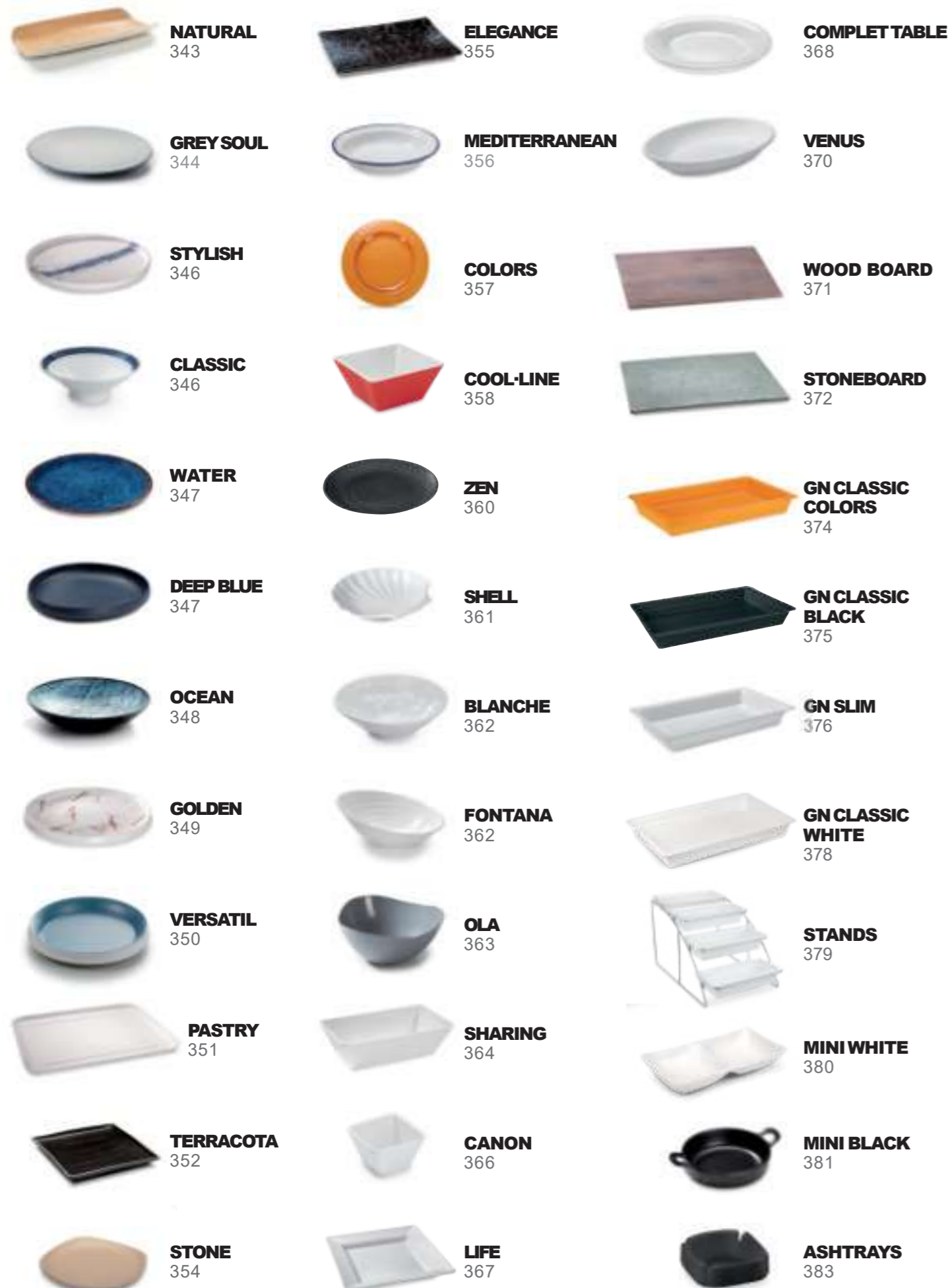

It is highly recommended for table & buffet service for its properties.

Es un material muy utilizado en el servicio de mesa y presentación por sus propiedades.

Très utilisée dans le service de table et buffet par ses propriétés.



Melamine is a synthetic resin which becomes harden and Formed after heating

La melamina es una resina sintética que se endurece y toma forma después de un proceso de calentamiento

La mélamine est une résine Synthétique qui se durcit et prend-forme après un processus spécial de Chauffage

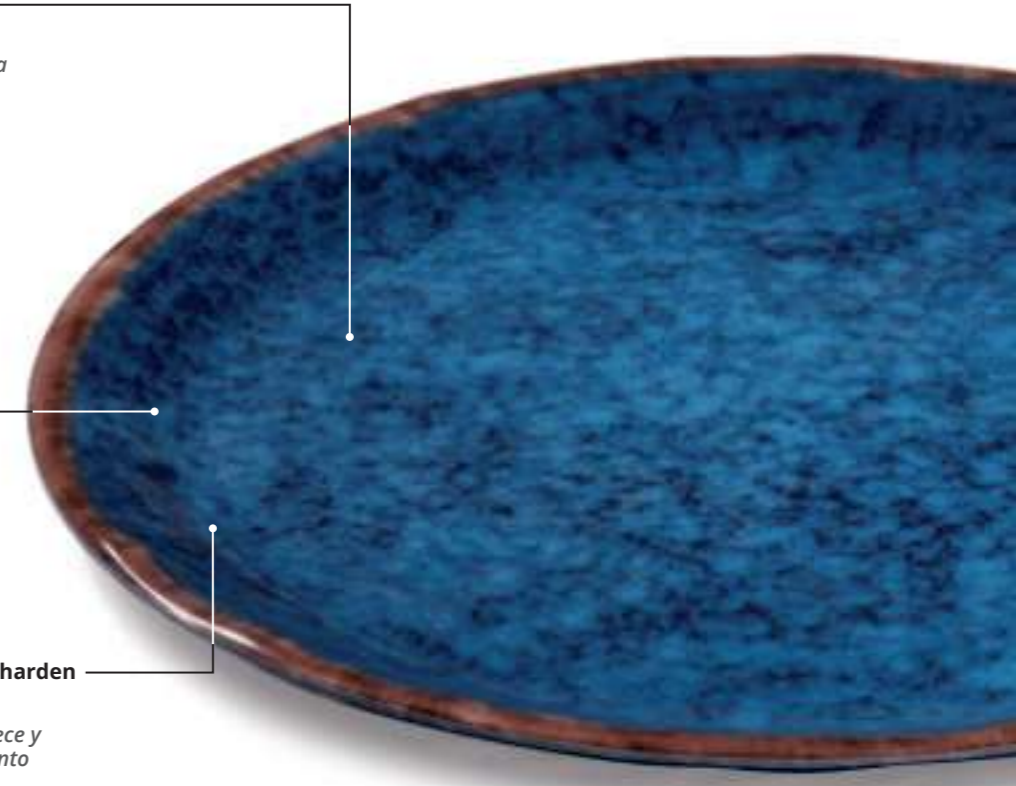

MAIN FEATURES CARACTERÍSTICAS PRINCIPALES CARACTÉRISTIQUES

SGS Food contact approved: certified by SGS
Contacto con alimentos: certificado por SGS
Contact avec aliments: certifié par SGS

+70°C
-20°C Withstands temperatures: -20°C & +70°C
Condiciones de trabajo: entre -20°C y +70°C
Températures entre: -20°C et +70°C

USES USOS USAGES

Not recommended: Microwave
No recomendada: Microondas
Non recommandée: Micro-ondes

Not recommended: Oven
No recomendada: Horno
Non recommandée: Four

Not recommended: Direct flame
No recomendada: Directo al fuego
Non recommandée; Direct au feu

Not recommended: Oil and chemical products
No recomendada: Aceite y productos químicos
Non recommandée: Huile ou produits chimiques

PROPERTIES PROPIEDADES PROPRIÉTÉS

Heat resistant
Resistente al calor
Résistante à la chaleur

Corrosion resistant
Resistente a la corrosión
Résistante à la corrosion

Non-toxic
No tóxico
Non-toxique

Non-odorous
Inodoro
Inodore

Light weight
Ligero
Légère

Free form deformation
Indeformable
Indéformable

Low heat conductivity
Poco conductor del calor
Baisse conductivité de la chaleur

MELAMINE
MELAMINA
MELAMINE

MELAMINE
MELAMINA
MELAMINE



Me
Melamine

NEW!

P22377 Plate
Plato
Assiette



REF		Ø cm	H cm	
P22377		23	2,0	12
P22378		26	2,2	12
P22386		23	2,0	12
P22387		26	2,2	12

P22379 Bowl
Bol
Bol



REF		Ø cm	H cm	
P22379		14	3,5	12
P22380		18	4,5	12
P22388		14	3,5	12
P22389		18	4,5	12

P22381 Deep plate
Plato hondo
Assiette creuse



REF		Ø cm	H cm	
P22381		25	5,7	6
P22390		25	5,7	6

P22382 Plate
Plato
Assiette



REF		Ø cm	H cm	
P22382		15,2	2,7	6
P22384		21,5	3,1	6
P22385		24,0	3,4	4
P22391		15,2	2,7	6
P22393		21,5	3,1	6
P22394		24,0	3,4	4



Me
Melamine

NEW!

P22409 Rectangular tray
Bandeja rectangular
Plateau rectangulaire



REF		W x D x H cm	
P22409		39,1 x 16,5 x 3,2	1

P22410 Oval plate
Plato ovalado
Assiette ovale



REF		W x D x H cm	
P22410		24,1 x 17,2 x 3,5	1

P22411 Display tray
Bandeja presentación
Plateau de présentation



REF		W x D x H cm	
P22411		54 x 27 x 2	1

P22412 Rectangular tray
Bandeja rectangular
Plateau rectangulaire



REF		W x D x H cm	
P22412		40 x 30 x 2,15	1

MELAMINE
MELAMINA
MELAMINE

MELAMINE
MELAMINA
MELAMINE



NEW!

P22413 Gray plate
Plato gris
Assiette grise



REF	Ø cm	H cm	
P22413	22	1,5	1
P22414	27	1,6	1

P22415 Blue plate
Plato azul
Assiette bleue



REF	Ø cm	H cm	
P22415	22	1,5	1
P22416	27	1,6	1

P22417 White plate
Plato blanco
Assiette blanche



REF	Ø cm	H cm	
P22417	22	1,5	1
P22418	27	1,6	1

See products on **P. 357**
Ver productos en / Voir produits en page



NEW!

P22368 Ripple ramekin
Ramekin ondulado
Ramequin ondulé



REF	cm	H cm	ml	
P22368	Ø 6,2	3,5	60	48

P22369 Ripple ramekin
Ramekin ondulado
Ramequin ondulé



REF	cm	H cm	ml	
P22369	Ø 7,8	4,3	120	48

P22370 Ripple serving bowl
Bol ondulado
Bol ondulé



REF	cm	H cm	
P22370	Ø 14	9	12

P22371 Ripple serving bowl
Bol ondulado
Bol ondulé



REF	cm	H cm	
P22371	Ø 20	7	12

P22372 Ripple serving bowl
Bol ondulado
Bol ondulé



REF	cm	H cm	
P22372	Ø 25	15	6



NEW!

P22404 Oval plate
Plato ovalado
Assiette ovale



REF	W x D x H cm	
P22404	21,5 x 11 x 4,5	12

P22405 Oval bowl
Bol ovalado
Bol ovale



REF	W x D x H cm	
P22405	16,5 x 10 x 5,7	12
P22406	20 x 15,5 x 10	12
P22407	26 x 16 x 13,3	6

P22408 Oval bowl
Bol ovalado
Bol ovale



REF	W x D x H cm	
P22408	32,5 x 26,5 x 18	3



NEW!

P22399 Round bowl
Bol redondo
Bol rond



REF	Ø cm	H cm	
P22399	22,5	7	3
P22400	29,0	10	3

P22401 Round bowl
Bol redondo
Bol rond



REF	Ø cm	H cm	
P22401	34,5	7	3

P22402 Buffet display
Expositor buffet
Présentoir buffet



Compatible with
Compatible con P22399, P22400 y P22401
Compatible avec

REF	Ø cm	H cm	
P22402	16,5	10	6
P22403	16,5	18	6



Fitting system with the base
that provides stability

*Sistema de encaje con la base
que aporta estabilidad*

*Système d'assemblage avec la
base qui assure la stabilité*



13 Buffet display

Expositor buffet
Présentoir buffet



NEW!

P22338 Buffet display
Expositor buffet
Présentoir buffet



Compatible with
Compatible con **P22361 P22362 y P22363**
Compatible avec

REF	Ø cm	H cm	
P22366	16,5	10	6
P22367	16,5	18	6

P22338 Display tray
Bandeja presentación
Plateau présentation



REF	Ø cm	H cm	
P22361	22,7	1,5	1
P22362	27,8	1,5	1
P22363	32,7	1,5	1

The three pieces are sold separately
Las tres piezas se venden por separado
Les trois pièces sont vendues séparément

See products on
Ver productos en / Voir produits en page

P. 395

Dome cover
Tapa campana
Couvercle cloche



Fitting system with the base that provides stability
Sistema de encaje con la base que aporta estabilidad
Système d'assemblage avec la base qui assure la stabilité

Hidraulica 13



NEW!

P22373 Display tray 1/1
Bandeja presentación 1/1
Plateau présentation 1/1



REF	GN	W x D x H cm	
P22373	1/1	53 x 32,5 x 1,8	1

P22375 Display tray 1/3
Bandeja presentación 1/3
Plateau présentation 1/3



REF	GN	W x D x H cm	
P22375	1/3	32,5 x 17,6 x 1,8	1

P22374 Display tray 1/2
Bandeja presentación 1/2
Plateau présentation 1/2



REF	GN	W x D x H cm	
P22374	1/2	32,5 x 26,5 x 1,8	1

P22376 Display tray 2/4
Bandeja presentación 2/4
Plateau présentation 2/4



REF	GN	W x D x H cm	
P22376	2/4	53 x 16,2 x 1,8	1

See products on
Ver productos en / Voir produits en page

P. 397

Clear GN lids for presentation
Tapas GN transparentes presentación
Couvercles GN transparents de présentation





NEW!

P22424 Serving board
Tabla presentación
Table de présentation



REF	W x D x H cm	
P22424	37,5 x 14 x 1,5	1

P22426 Serving board
Tabla presentación
Table de présentation



REF	W x D x H cm	
P22426	28 x 15,5 x 1,5	1

P22127 Display plate
Soporte presentación
Présentoir



REF	Ø cm	H cm	
P22127	23,0	1,5	1
P22128	28,0	1,5	1
P22129	32,5	1,5	1

P22425 Serving board
Tabla presentación
Table de présentation



REF	W x D x H cm	
P22425	42 x 18 x 1,6	1

P22427 Serving board
Tabla presentación
Table de présentation



REF	W x D x H cm	
P22427	40,5 x 25,5 x 1,55	1

P2265 Oven oak peel
Pala horno roble
Pelle four chêne



REF	cm	
P22650	Ø 30	6
P22651	53 x 20	6
P22652	61 x 20	6



P22324 Rectangular tray
Bandeja rectangular
Plateau rectangulaire



REF	W x D x H cm	GN	
P22324	32,5 x 26,5 x 4	1/2	1
P22328	32,5 x 26,5 x 4	1/2	1

P22323 Rectangular tray
Bandeja rectangular
Plateau rectangulaire



REF	W x D x H cm	GN	
P22323	32,5 x 17,6 x 4	1/3	1
P22327	32,5 x 17,6 x 4	1/3	1

P22322 Rectangular tray
Bandeja rectangular
Plateau rectangulaire



REF	W x D x H cm	GN	
P22322	53 x 16,5 x 4	2/4	1
P22326	53 x 16,5 x 4	2/4	1

P22325 Leaf plate
Bandeja forma hoja
Plateau forme feuille



REF	W x D x H cm	
P22325	37,5 x 15 x 2	1

MELAMINE
MELAMINA
MELAMINE

MELAMINE
MELAMINA
MELAMINE

13 Grey Soul



Me
Melamine

P22888 Square plate
Plato cuadrado
Assiette carrée



REF	W x D x H cm	
P22888	15 x 15 x 2,00	1
P22889	18 x 18 x 2,00	1
P22891	21 x 21 x 2,05	1

P22892 Triangular plate
Plato triangular
Assiette triangulaire



REF	W x D x H cm	
P22892	20 x 20 x 6,8	1

P22893 Rectangular tray
Bandeja rectangular
Plateau rectangulaire



REF	W x D x H cm	
P22893	21,6 x 11 x 2,5	1
P22894	29 x 11 x 2,5	1

P22896 Snacks or sauce tray
Bandeja snacks o salsas
Plateaux sauces



REF	W x D x H cm	
P22896	6,5 x 6,5 x 2,8	1
P22897	11,5 x 6,5 x 2,8	1

P22898 Slanted round bowl
Bol redondo inclinado
Bol rond incliné



REF	Ø cm	H cm	
P22898	14,5	10,5	1
P22899	17,5	12,2	1

P22308 Tapas dish
Plato tapas
Plat à tapas



REF	Ø cm	H cm	
P22308	14,0	2,5	1
P22309	16,5	2,8	1

Grey Soul 13

Me
Melamine

P22306 Plate
Plato
Assiete



REF	Ø cm	H cm	
P22306	19,0	2,0	1
P22307	21,5	2,5	1

P22303 Round bowl
Bol redondo
Bol rond



REF	Ø cm	H cm	
P22303	14,5	5,5	1
P22304	24,0	6,0	1

P22305 Conical bowl
Bol cónico
Bol conique



REF	Ø cm	H cm	
P22305	12	6,5	1

P22895 Round bowl
Bol redondo
Bol rond



REF	Ø cm	H cm	
P22895	11	4,5	1

P22301 Oval serving dish
Fuente oval
Plat ovale



REF	W x D x H cm	
P22301	29,5 x 18 x 3,5	1
P22302	34,5 x 22 x 4	1

P22422 Rectangular plate
Plato rectangular
Assiette rectangulaire



NEW!

REF	W x D x H cm	
P22422	32,7 x 9 x 5,8	1

P22423 Oval plate
Plato ovalado
Assiette ovale



NEW!

REF	W x D x H cm	
P22423	34,5 x 10,3 x 6 cm	1

13 Stylish



P22333 Plate
Plato
Assiette



REF	Ø cm	H cm	
P22333	20	2,0	1
P22334	27	2,5	1
P22335	31	3,0	1

Water 13



P22318 Plate
Plato
Assiette



REF	Ø cm	H cm	
P22318	25,0	1,5	1
P22319	27,5	1,5	1
P22320	30,0	1,5	1

P22321 Deep dish
Plato hondo
Assiette creuse



REF	W x D x H cm	
P22321	23 x 17,5 x 6,5	1

Classic

P22329 Conical bowl
Bol cónico
Bol conique



REF	Ø cm	H cm	
P22329	17	6	1
P22330	22	8	1
P22331	25	9	1

Deep Blue

P22332 Serving plate
Plato presentación
Assiette présentation



REF	W x D x H cm	
P22332	30 x 28,5 x 4,5	1



Me
Melamine



Me
Melamine

P22316 Round bowl
Bol redondo
Bol rond



REF	Ø cm	H cm	
P22316	17	5	1

P22317 Deep dish
Plato hondo
Assiette creuse



REF	Ø cm	H cm	
P22317	22,5	5	1

P22314 Plate
Plato
Assiette



REF	Ø cm	H cm	
P22314	22	2	1
P22315	27	2	1

P22313 Rectangular tray
Bandeja rectangular
Plateau rectangulaire



REF	cm	H cm	GN	
P22313	53,0 x 32,5	2	1/1	1
P22312	32,5 x 26,5	2	1/2	1
P22310	32,5 x 17,6	2	1/3	1
P22311	53,0 x 16,5	2	2/4	1

P22344 Plate
Plato
Assiete



REF	Ø cm	H cm	
P22344	23,0	3,0	1
P22345	27,5	3,5	1
P22346	32,0	4,0	1

P22347 Serving plate
Plato presentación
Assiette présentation



REF	W x D x H cm	
P22347	29 x 26,5 x 1,5	1

P22886 Serving plate
Plato presentación
Assiette présentation



REF	W x D x H cm	
P22886	25,9 x 16,7 x 2	1

P22348 Oval serving dish
Fuente oval
Plat ovale



REF	W x D x H cm	
P22348	30,5 x 11 x 3	1
P22884	35,5 x 12,8 x 3	1
P22885	40,6 x 14,7 x 3	1

P22887 Plate 2 compartments
Plato 2 compartimentos
Assiette 2 compartiments



REF	W x D x H cm	
P22887	28,4 x 11 x 2,5	1

MELAMINE
MELAMINA
MELAMINE

MELAMINE
MELAMINA
MELAMINE



P22339 Tapas dish
Plato tapas
Plat à tapas



REF	W x D x H cm	☐
P22339	13 x 15,5 x 4	1
P22341	15 x 15 x 2,5	1

P22336 Deep dish
Plato hondo
Assiette creuse



REF	Ø cm	H cm	☐
P22336	25,5	5,5	1

P22342 Rectangular tray
Bandeja rectangular
Plateau rectangulaire



P22340 Plate
Plato
Assiete



REF	Ø cm	H cm	☐
P22340	19,5	3	1

P22337 Oval serving dish
Fuente oval
Plat ovale



REF	W x D x H cm	☐
P22337	23 x 16,5 x 3	1
P22338	28 x 20 x 3	1

REF	W x D x H cm	☐
P22342	31,5 x 23 x 3	1
P22343	33,5 x 13 x 3	1



P23990 Display tray
Bandeja presentación
Plateau présentation



REF	Mod	L mm	H cm	☐
P23990	1/1	530 x 325	1,8	12
P23991	1/2	325 x 265	1,8	24
P23992	1/3	325 x 176	1,8	36
P23993	2/4	530 x 162	1,8	24

P22775 Confectionery tray
Bandeja repostería
Plateau à pâtisserie



REF	H cm	cm	H cm	☐
P22775	2	36,5 x 29,5	2	1
P22778	2	36,5 x 29,5	2	1
P22779	2	36,5 x 29,5	2	1

See products on
Ver productos en / Voir produits en page

P. 397

Clear GN lids for presentation
Tapas GN transparentes presentación
Couvercles GN transparents de présentation



13 Terracota



Terracota 13



P22740 Tapas dish
Plato tapas
Plat à tapas



REF	Ø cm	H cm	
P22740	19,0	4,0	1
P22741	24,0	5,1	1
P22742	28,5	6,5	1
P22743	35,5	6,5	1

P22744 Tapas dish
Plato tapas
Plat à tapas



REF	Ø cm	H cm	
P22744	10,5	3,5	1
P22745	13,0	4,0	1
P22746	15,5	4,5	1

P22700 Conical bowl
Bol cónico
Bol conique



REF	Ø cm	H cm	
P22700	9,5	5,5	1
P22701	11,5	5,5	1
P22702	15,0	6,0	1
P22703	18,0	9,5	1
P22704	20,5	7,5	1
P22705	23,0	8,0	1

P22710 Tapas dish
Plato tapas
Plat à tapas



REF	Ø cm	H cm	
P22710	10,5	3,5	1
P22711	15,5	4,5	1
P22712	18,0	4,5	1

P22750 Square tray
Bandeja cuadrada
Plateau carré



REF	W x D x H cm	
P22750	20,5 x 20,5 x 3	1
P22751	25,5 x 25,5 x 3,5	1
P22752	29 x 29 x 4	1

P22755 Rectangular tray
Bandeja rectangular
Plateau rectangulaire



REF	W x D x H cm	
P22755	21 x 11 x 2	1
P22756	26 x 13 x 3	1

P22760 Snacks or sauce tray
Bandeja snacks o salsas
Plateaux sauces



REF	W x D x H cm	
P22760	29,5 x 9,5 x 3	1

P22770 Serving plate
Plato presentación
Assiette présentation



REF	W x D x H cm	
P22770	22 x 18,5 x 1	1
P22772	44,5 x 35 x 1,5	1

P22999 Black melamine wok
Wok negro de melamina
Wok noir en mélamine



REF	W x D x H cm	
P22999	38 x 30 x 10	1

P22419 6 compartment tray
Bandeja 6 compartimentos
Plateau 6 compartiments



REF	W x D x H cm	
P22419	41 x 7 x 3,8	1



P22824 Round bowl
Bol redondo
Bol rond



REF	Ø cm	H cm	
P22824	11,5	4,0	1
P22823	14,0	5,5	1
P22825	19,0	6,5	1

P22815 Plate
Plato
Assiette



REF	Ø cm	H cm	
P22815	22,5	3,0	1
P22816	25,0	3,0	1
P22817	27,5	3,5	1

P22850 Curved board
Tabla presentación curvada
Planche incurvée préentaion



REF	W x D x H cm	
P22850	20 x 14 x 2	1
P22851	25 x 17,5 x 2,5	1
P22852	30 x 20 x 2,5	1

P22800 Serving board
Tabla presentación
Planche de service



REF	W x D x H cm	
P22800	21 x 12 x 2,5	1
P22801	24 x 14 x 2,5	1
P22802	27 x 18 x 2,5	1
P22803	33 x 19 x 2,5	1



P22782 Oblong display tray
Bandeja exhibición rectangular
Plateau rectangulaire



REF	W x D x H cm	
P22782	35 x 25 x 4	1

P22780 Oblong plate
Fuente rectangular
Plateau rectangulaire



REF	W x D x H cm	
P22780	25 x 16 x 3	1

P22781 Rectangular tray
Bandeja rectangular
Plateau rectangulaire



REF	W x D x H cm	
P22781	32 x 12 x 2,5	1

P22783 Oval serving dish
Fuente oval
Plat ovale



REF	W x D x H cm	
P22783	35 x 15 x 2,5	1

P22784 Leaf plate
Bandeja forma hoja
Plateau forme feuille



REF	W x D x H cm	
P22784	34,5 x 13,5 x 3	1

13 Mediterranean



P22725 Dish
Plato
Assiette



REF	Ø cm	H cm	
P22720	22,0	2,0	1
P22725	27,0	2,0	1

P22726 Deep dish
Plato hondo
Assiette creuse



REF	Ø cm	H cm	
P22726	20,0	3,5	1

P22727 Oblong plate
Fuente rectangular
Plateau rectangulaire



REF	W x D x H cm	H cm	
P22727	20 x 14,5 x 4,5	4,5	1
P22728	23 x 17,5 x 4,5	4,5	1
P22729	27 x 20 x 4,5	4,5	1

P22758 Round bowl
Bol redondo
Bol rond



REF	Ø cm	H cm	
P22758	12,5	7,0	1

P22759 Glass
Vaso
Verre



REF	Ø cm	H cm	
P22759	8,0	9,5	1

Colors 13



P22830 Serving plate
Plato presentación
Assiette présentation



Yellow / Amarillo / Jaune

REF	Ø cm	H cm	
P22830	22	2,5	1
P22833	28	2,5	1

P22834 Serving plate
Plato presentación
Assiette présentation



Grey / Gris / Gris

REF	Ø cm	H cm	
P22834	22	2,5	1
P22835	28	2,5	1

P22838 Serving plate
Plato presentación
Assiette présentation



Orange / Naranja

REF	Ø cm	H cm	
P22838	22	2,5	1
P22839	28	2,5	1

P22844 Serving plate
Plato presentación
Assiette présentation



Red / Rojo / Rouge

REF	Ø cm	H cm	
P22844	22	2,5	1
P22845	28	2,5	1

MELAMINE
MELAMINA
MELAMINE

MELAMINE
MELAMINA
MELAMINE

13 Cool-line



Me
Melamine

Cool-line 13



P22884 Glass
Vaso
Verre

P23800 Mini round casserole with lid
Mini cacerola con tapa
Mini cocotte avec couvercle

P22370 Two tones deep squared bowl
Bol cuadrado hondo dos colores
Bol carré deux couleurs

P22371 Two tones deep squared bowl
Bol cuadrado hondo dos colores
Bol carré deux couleurs



REF	Ø cm	H cm	ml	
P22884A	8,5	9	30	1
P22884N	8,5	9	30	1
P22884G	8,5	9	30	1
P22884R	8,5	9	30	1
P22884B	8,5	9	30	1
P22884NE	8,5	9	30	1

REF	Ø cm	H cm	
P23800A	10	6,5	1
P23800N	10	6,5	1
P23800G	10	6,5	1
P23800R	10	6,5	1

REF	W x D x H cm	
P22370A	9 x 9 x 5,5	1
P22370N	9 x 9 x 5,5	1
P22370G	9 x 9 x 5,5	1
P22370R	9 x 9 x 5,5	1

REF	W x D x H cm	
P22371A	18 x 18 x 8,5	1
P22371N	18 x 18 x 8,5	1
P22371G	18 x 18 x 8,5	1
P22371R	18 x 18 x 8,5	1

P22223 Wood base for 3 mini casseroles
Base de madera para 3 mini cacerolas
Base en bois pour 3 mini cocottes

Wo
Wood



REF	W x D x H cm	
P22223	43 x 15,5 x 5,1	1



IDEA! Suitable for P23800, P23800A, P23800N, P23800G, P23800R.
Compatible con P23800, P23800A, P23800N, P23800G, P23800R.
Adaptable pour P23800, P23800A, P23800N, P23800G, P23800R.

P590007 Lid
Tapa
Couvercle

PP
Polypropylene



Price / Precio / Prix : Pack 6 u

Non-hermetic closure
Cierre no hermético
Fermeture non hermétique

Minimum purchase: pack of 6 units
Compra mínima: pack 6u
Achat minimum : pack de 6 unités

REF	W x D x H cm	
P590007	18 x 18 x 2,5	6



IDEA! Suitable for 18 x 18 deep squared bowl.
Compatible con bol cuadrado hondo 18x18.
Adaptable pour bol carré 18 x 18.



P2290 Dish
Plato
Assiette



REF	Ø cm	H cm	
P22901	19,5	2,8	12
P22902	28,0	2,9	12

P2291 Bowl
Bol
Bol



REF	Ø cm	H cm	
P22911	10,1	4,0	12
P22912	11,5	5,8	12

P2294 Rectangular Tray
Bandeja rectangular
Plateau rectangulaire



REF	W x D x H cm	
P22940	23,4 x 14,7 x 2,5	12

P2297 Noodles bowl
Bol para noodels
Bol pour nouilles



REF	Ø cm	H cm	
P22971	17,3	7,6	12
P22972	25,0	8,7	6

P2296 Sauce bowl
Bol para salsas
Bol pour sauces



REF	Ø cm	H cm	
P22960	11,5	5,5	20

P2295 Dish for bowl
Plato para bol
Assiette pour bol



REF	W x D x H cm	
P22950	15,9 x 12,7 x 2,3	12

IDEA! Suitable for P22950.
Compatible con P22950.
Adaptable pour P22950.

IDEA! Suitable for P22960.
Compatible con P22960.
Adaptable pour P22960.



P22354 Plate
Fuente
Plateau



P22354

REF	W x D x H cm	
P22354	25 x 23,5 x 3	1
P22355	40 x 38,5 x 6,5	1

P22356 Plate
Fuente
Plateau



REF	W x D x H cm	
P22356	35 x 26,5 x 3,5	1
P22357	46 x 35 x 5	1

P22358 Plate
Fuente
Plateau



REF	W x D x H cm	
P22358	28,5 x 27,5	1



Me
Melamine



Me
Melamine

P22420 Rectangular tray
Bandeja rectangular
Plateau rectangulaire



REF	W x D x H cm	
P22420	26,5 x 11 x 2,3	1
P22421	37 x 11 x 2,5	1

P22349 Rectangular tray
Bandeja rectangular
Plateau rectangulaire



REF	W x D x H cm	
P22349	25 x 18 x 3,5	1
P22350	30 x 21,5 x 4	1
P22351	35 x 25 x 4	1

Fontana

P22352 Round bowl
Bol redondo
Bol rond



REF	Ø cm	H cm	
P22352	17,5	5,5	1
P22353	24,0	8,0	1

P22359 Slanted round bowl
Bol redondo inclinado
Bol rond incliné



REF	W x D x H cm	
P22359	35,5 x 32 x 14,5	1
P22360	46 x 40,5 x 18,5	1

P2297 Round bowl
Bol redondo
Bol rond



REF	Ø cm	H cm	
P22973	25	11	1
P22974	28	12	1
P22975	35	15	1

P22169 Oval bowl
Bol oval
Bol ovale



REF	W x D x H cm	
P22169	29 x 16,5 x 15	6

P22170 Leaf plate
Bandeja forma hoja
Plateau forme feuille



REF	W x D x H cm	
P22170	50,5 x 24 x 7	3

P2217 Spin round bowl
Bol torneado
Bol tourné



REF	Ø cm	H cm	
P22171	20,5	9,5	3
P22172	24,5	10,5	3
P22173	28,0	12,0	3

13 Sharing



Me
Melamine

P22037 High oblong plate
Fuente rectangular alta
Plateau rectangular haut



REF	W x D x H cm	
P22037	50 x 20 x 5	3

P22038 High oblong plate
Fuente rectangular alta
Plateau rectangular haut



REF	W x D x H cm	
P22038	35 x 25 x 5	3

P22164 High oblong serving dish
Fuente rectangular alta
Plateau rectangular haut



REF	W x D x H cm	
P22164	25 x 15 x 7	3
P22165	35 x 25 x 7	3
P22166	45 x 30 x 7	2

P22103 5 - Compartment bowl
Bandeja 5 compartimentos
Bol 5 compartiments



IDEA! Central space ideal for sauces and dips.
Espacio central ideal para salsas y dips.
Espace central idéal pour sauces et tartiner.

REF	Ø cm	H cm	
P22103	38	6,5	3

Sharing 13

Me
Melamine

P22501 Oval serving dish
Fuente oval
Plat ovale



REF	W x D x H cm	
P22501	32,5 x 20 x 4	1
P22502	43,5 x 26,5 x 4	1

P2210 Round bowl
Bol redondo
Bol rond



REF	Ø cm	H cm	
P22100	16	9	6
P22101	26	10	6
P22102	36	13	3

P2222 Bamboo displayer with 3 bowls
Expositor bambú con 3 bols
Présentoir bambou avec 3 bols

Wo
Wood

Me
Melamine



REF	L cm	Ø cm	H cm	Lts	
P22220	29,0	11	3,5	0,20	6
P22221	40,0	13	6,0	0,50	6
P22222	49,5	16	8,5	1,10	6

P2216 Conical bowl
Bol cónico
Bol conique



REF	Ø cm	H cm	
P22167	13	8,5	6
P22168	16	10,8	6

P22003 Squared display plate
Bandeja exhibición cuadrada
Plateau carré présentation



REF	W x D x H cm	
P220031	31 x 31 x 4	3
P22003	35 x 35 x 4	3
P220033	42 x 42 x 5	3

P22177 Round plate
Bandeja redonda
Plateau rond



REF	Ø cm	H cm	
P22177	35	3,5	3



P22002 Squared display plate
Bandeja exhibición cuadrada
Plateau carré présentation



REF	W x D x H cm	
P220021	30,5 x 30,5 x 3,5	3
P22002	35,5 x 30,5 x 4	3
P220023	40,5 x 40,5 x 4,5	3

P222 Deep squared bowl
Bol cuadrado hondo
Bol carré



REF	W x D x H cm	
P22211	7 x 7 x 4,2	24
P22200	9 x 9 x 5,5	12
P22201	13 x 13 x 7	6
P22202*	18 x 18 x 8,5	6
P22203	24 x 24 x 10	3
P22204	30 x 30 x 11,5	3

P2200 Squared tray
Fuente cuadrada
Plateau carré



REF	W x D x H cm	
P22001	33,5 x 33,5 x 5,5	3
P22000	37,3 x 37,3 x 2,8	3

P2201 Oblong plate
Fuente rectangular
Plateau rectangulaire



REF	W x D x H cm	
P22012	35,8 x 20,5 x 3,8	3
P22013	44,3 x 22,1 x 4,4	3
P22014	49,5 x 27,2 x 5,6	3
P22015	55,7 x 32,2 x 5,2	3
P22016	71 x 40,5 x 5,3	3

P2220 Two tones deep squared bowl
Bol cuadrado hondo dos colores
Bol carré deux couleurs



REF	W x D x H cm	Red Rojo Rouge	Blue Azul Bleu	Yellow Amarillo Jaune	Green Verde Vert	Black Negro Noir	
P22200	9 x 9 x 5,5	R	A	AM	V	N	12
P22202	18 x 18 x 8,5*	R	A	AM	V	N	6
P22203	24 x 24 x 10	R	A	AM	V	N	3

REF + Color code / REF + Código color / REF + Code couleur

See products on **P. 415**
Ver productos en / Voir produits en page

- * Fits in CUBIC display.
- * Encaja en expositores CUBIC.
- * Adaptable aux présentoirs CUBIC.



P2208 Oblong display tray
Bandeja exhibición rectangular
Plateau rectangulaire



REF	W x D x H cm	
P22085	39 x 15 x 1,5	6
P22086	50 x 18 x 1,8	6

P22099 Bowl - plate
Plato - bol
Plat - bol



REF	Ø cm	H cm	
P22099	38	9	6

P2215 Gastronorm tray
Bandeja gastronorm
Plateau gastronorme



REF	W x D x H cm	
P22150	53 x 32,5 x 2	3
P22151	32,5 x 26,5 x 2	6

P22004 Deep squared bowl
Bol cuadrado
Bol carré



REF	W x D x H cm	
P22004	25 x 25 x 8,8	3
P22005	37,5 x 37,5 x 9	3

13 Complet Table



P2211 Round dish
Plato
Assiette plate



REF	Ø cm	H cm	
P22111	16,0	2,3	12
P22112	20,0	2,3	12
P22113	23,0	2,3	6
P22114	26,5	2,3	6

P22115 Soup plate
Plato sopa
Assiette à soupe



REF	Ø cm	H cm	
P22115	24	3,7	6

P22116 Big salad bowl
Bol grande
Saladier grand



REF	Ø cm	H cm	
P22116	19	5	6

P22182 Oval dish
Plato oval
Assiette ovale



REF	W x D x H cm	
P22182	24,3 x 18,2 x 2,1	6
P22183	30,5 x 23,2 x 2,5	6
P22184	34,2 x 26,8 x 2,7	6

Complet Table 13



P2225 Stackable bowl
Bol cereales encastable
Bol empilable



REF	Ø cm	H cm	
P22250	12	4,5	12
P22251	14	5,5	12

P22117 Small salad bowl
Bol pequeño
Saladier petit



REF	Ø cm	H cm	
P22117	14	6	12

P22178 Cup - Plate
Taza - Plato
Tasse - Assiette



	REF	Size	Ø cm	H cm	Lts	
Cup / Taza Tasse	P22178	S	7,0	4,8	0,10	12
	P22180	L	9,8	6,5	0,25	12
Plate / Plato Assiette	P22179	S	10,3	-	-	12
	P22181	L	14,4	-	-	12

P22118 Stackable mug
Taza apilable
Tasse empilable



REF	Ø cm	H cm	Lts	
P22118	7,5	10	0,30	6

P22033 Slotted spoon
Cuchara perforada
Cuillère ajourée



REF	L cm	
P22033	30	24

P22034 Soup ladle
Cacillo
Louche



REF	L cm	Lts	
P22034	17	0,08	24

MELAMINE
MELAMINA
MELAMINE

MELAMINE
MELAMINA
MELAMINE

13 Venus



P22023 Oval plate
Fuente oval honda
Plateau ovale



REF	W x D x H cm	
P22023	50 x 36 x 6,7	3

P22022 Round bowl
Fuente redonda
Bol rond



REF	Ø cm	H cm	
P22022	36	7	3

P22019 Round bowl
Bol redondo
Bol rond



REF	Ø cm	H cm	
P22019	20	9,0	3
P22020	28	12,5	3

P22174 Slanted round bowl
Bol redondo inclinado
Bol rond incliné



REF	W x D x H cm	Lts	
P22174	21,2 x 20,8 x 10,4	0,60	6
P22175	30 x 29,1 x 13,7	1,60	3
P22176	36 x 34,9 x 16,3	2,85	3

P22090 Round plate presentation
Plato redondo de presentación
Plateau rond présentation



REF	Ø cm	H cm	
P22090	31	2	4

P22364 Round bowl
Bol redondo
Bol rond



REF	Ø cm	H cm	
P22364	22,5	11,5	3
P22365	26,0	14,0	3

Wood board 13



P2260 Oak display plate
Soporte presentación roble
Présentoir chêne



REF	Mod.	cm	
P22600	1/1	53,0 x 32,5	3
P22601	1/2	32,5 x 26,5	6
P22602	1/3	32,5 x 17,6	6
P22603	1/4	26,5 x 16,2	6
P22604	2/4	53,0 x 16,5	6

P2262 Oak serving tray
Bandeja presentación roble
Plateau présentation bois



REF	W x D x H cm	
P22620	30 x 15 x 1,8	12
P22621	30 x 20 x 1,8	12
P22622	40 x 30 x 1,8	6

P2261 Display plate
Soporte presentación
Présentoir



REF	Mod.	cm	Blanco White Blanc	Negro Black Noir	
P22610	1/1	53,0 x 32,5	B	N	3
P22611	1/2	32,5 x 26,5	B	N	4
P22614	2/4	53,0 x 16,5	B	N	6

REF + color code / REF + código color / REF + code couleur

P22664 White wood serving tray
Soporte presentación madera blanca
Plateau présentation bois blanc



REF	Mod.	W x D x H cm	
P22660	1/1	53 x 32,5 x 1	6
P22661	1/2	32,5 x 26,5 x 1	24
P22662	1/3	32,5 x 17,6 x 1	24
P22663	1/4	26,5 x 16,2 x 1	24
P22664	2/4	53 x 16,3 x 1	12

P22690 Slate display plate
Soporte presentación pizarra
Présentoir base ardoise



REF	Mod.	W x D x H cm	
P22690	1/2	32,5 x 26,5 x 1	24
P22691	1/3	32,5 x 17,5 x 1	24
P22692	1/4	26,5 x 16,0 x 0	24

P2264 Slate display plate
Bandeja base pizarra
Présentoir base ardoise

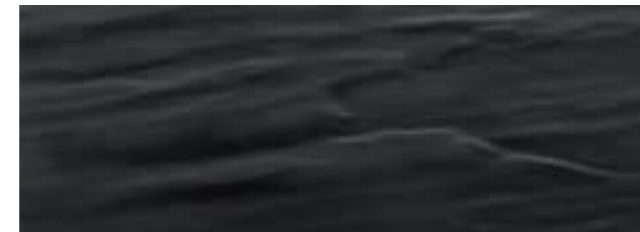

REF	Mod.	cm	
P22640N	1/2	32,5 x 26,5	6
P22641N	1/3	32,5 x 17,5	6
P22642N	1/4	26,5 x 16,0	6

P22161 Slate - granite Display plate
Soporte presentación Pizarra - granito
Presentoir Ardoise - granite



Reversible: 1 slate side - 1 granite side
Reversible: 1 cara pizarra - 1 cara granito
Réversible: 1 face ardoise - 1 face granite



REF	Mod.	W x D x H cm	
P22161	1/1	53,0 x 32,5 x 0,7	3
P22162	1/2	32,5 x 26,5 x 0,7	3

P22124 Display plate
Soporte presentación
Présentoir



REF	Ø cm	H cm	
P22124	23,0	1,5	1
P22125	28,0	1,5	1
P22126	32,5	1,5	1

P22144 Double face slate - bamboo display plate
P22145 Soporte presentación doble cara pizarra - bambú
Présentoir double face bambou - ardoise



Reversible: 1 slate side - 1 bamboo side
Reversible: 1 cara pizarra - 1 cara bambú
Réversible: 1 face ardoise - 1 face bambou

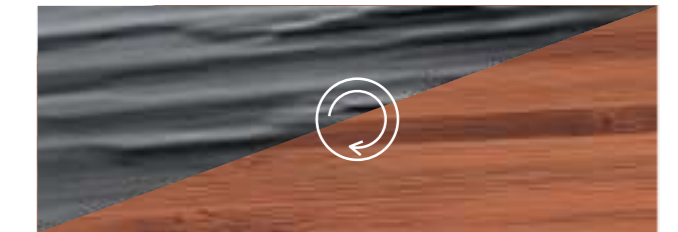

REF	Ø cm	H cm	
P22144	33	1	3
P22145	43	1	3

P22695 Marble display plate
Soporte presentación mármol
Présentoir base marbre



REF	Mod.	W x D x H cm	
P22695	1/1	53,0 x 32,5 x 2	9
P22696	1/2	32,5 x 26,5 x 2	12
P22697	1/3	32,5 x 17,6 x 2	24
P22698*		15 x 15x 9,5	48



GN 1/1 530 x 325 mm

Yellow
Amarillo
Jaune



REF	H mm	
P22866	20	6
P22867	40	3
P22868	65	2

Orange
Naranja
Orange



REF	H mm	
P22863	20	6
P22864	40	3
P22865	65	2

Red
Rojo
Rouge



REF	H mm	
P22869	20	6
P22870	40	3
P22871	65	2

Grey
Gris
Gris



REF	H mm	
P22860	20	6
P22861	40	3
P22862	65	2

GN 1/2 325 x 265 mm

Yellow
Amarillo
Jaune



REF	H mm	
P22878	20	6
P22879	40	3
P22880	65	2

Orange
Naranja
Orange



REF	H mm	
P22875	20	6
P22876	40	3
P22877	65	2

Red
Rojo
Rouge



REF	H mm	
P22881	20	6
P22882	40	3
P22883	65	2

Grey
Gris
Gris



REF	H mm	
P22872	20	6
P22873	40	3
P22874	65	2



GN 1/1 530 x 325 mm



REF	H mm	
P22051	20	6
P22053	40	3
P22009	65	2

GN 2/3 353 x 325 mm



REF	H mm	
P22047	65	3

GN 2/4 530 x 162 mm



REF	H mm	
P22049	65	3

GN 1/3 325 x 175 mm



REF	H mm	
P22011	65	3
P22080	100	3

GN 1/2 325 x 265 mm



REF	H mm	
P22039	20	6
P22041	40	3
P22010	65	3
P22084	100	3

GN 1/4 265 x 162 mm



REF	H mm	
P22043	65	3

GN 1/6 176 x 162 mm



REF	H mm	
P22045	65	6
P22082	100	6



GN 1/1 530 x 325 mm



REF	H mm	
P23030	20	12
P23031	65	6
P23032	100	6

GN 1/2 325 x 265 mm



REF	H mm	
P23033	20	24
P23034	65	12

GN 2/4 530 x 162 mm



REF	H mm	
P23044	20	12
P23045	65	12
P23046	100	12

GN 1/3 325 x 176 mm



REF	H mm	
P23036	20	24
P23037	65	24
P23038	100	12

GN SLIM SLIM PAN
CUBETA LIGERA
BAC LÉGER

ECONOMIC LINE
GAMA ECONÓMICA
GAMME ECONOMIQUE

IDEA! Ideal for cold buffets.
Ideal buffets fríos.
Idéal pour buffets froids

Stackable
Apilable
Empilable

Stylized
Estilizada
Stylisée

CLASSIC
Current pan
Cubeta tradicional
Bac traditionnel

1/1 1/2 1/4 1/3 2/4 1/6

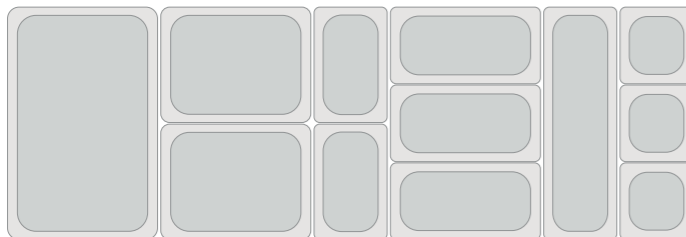

BASE
Strong structure
Estructura robusta
Structure robuste



GN 1/4 265 x 162 mm



REF	H mm	
P23039	20	48
P23040	65	24

GN 1/6 176 x 162 mm



REF	H mm	
P23042	65	24
P23043	100	24

MELAMINE
MELAMINA
MELAMINE

MELAMINE
MELAMINA
MELAMINE

GN 1/1 530 x 325 mm



REF	H mm	
P22052	20	6
P22054	40	3
P22006	65	2

GN 1/2 325 x 265 mm



REF	H mm	
P22040	20	6
P22042	40	3
P22007	65	3
P22083	100	3

GN 2/3 353 x 325 mm



REF	H mm	
P22048	65	3

GN 1/3 325 x 175 mm



REF	H mm	
P22094	20	6
P22008	65	3
P22079	100	3

GN 2/4 530 x 162 mm



REF	H mm	
P22087	20	6
P22050	65	3

GN 1/4 265 x 162 mm



REF	H mm	
P22044	65	3

GN 1/6 176 x 162 mm



REF	H mm	
P22046	65	6
P22081	100	6

P22154 1/1 Gastronorm buffet displayer Expositor buffet para cubetas GN 1/1 Présentoir buffet pour bacs GN 1/1



REF	tipo/type	W x D x H cm	
P22154	1/1	56,5 x 52,5 x 32,5	6

P22156 1/3 Gastronorm buffet displayer Expositor buffet para cubetas GN 1/3 Présentoir buffet pour bacs GN 1/3



Containers not included
Cubetas no incluidas
Bacs non inclus

REF	tipo/type	W x D x H cm	
P22156	1/3	36 x 52,5 x 32,5	6

P22158 4 Cocks system stand Expositor 4 vasijas Présentoir 4 cruches



P22160
Cocks not included
Vasijas no incluidas
Cruches pas incluses

REF	W x D x H cm	
P22158	19 x 52,5 x 32,5	6

P22160 1l crock Vasija 1l Cruche 1l



REF	Ø cm	H cm	
P22160	13	10,5	6

13 Mini White



P22108 Squared bowl
Platillo cuadrado
Bol carré



REF	W x D x H cm	Lts	📦
P22108	10 x 10 x 3,3	0,10	24
P22109	12,5 x 12,5 x 3,5	0,18	24

P22088 Egg cup
Platillo para huevo
Coquetier



REF	W x D x H cm	📦
P22088	11,5 x 11,5 x 2	24

P22119 Snack or sauce melamine tray
Bandeja melamina snacks o salsas
Plateaux mélamine snacks ou sauces



NEW!

2 compartments
2 compartimentos
2 compartiments

REF	W x D x H cm	📦
P22119	17,5 x 8,5 x 3,5	1

P867 Ramekin
Recipiente para salsas
Récipient pour sauces



P22104 Mini square plate
Mini bandeja presentación
Plateau miniature



REF	W x D x H cm	📦
P22104	12,5 x 10,5 x 2	24
P22105	14 x 13 x 2	24
P22106	17 x 14 x 2,5	24

P22890 Small tray
Fuente rectangular
Ravier rectangulaire



Stackable
Apilable
Empilable



REF	W x D x H cm	📦
P22890	13 x 9 x 2	24

P22110 Party spoon
Cuchara degustación
Cuillère amuse bouche



REF	W x D x H cm	📦
P22110	14,5 x 4,5 x 5	60

REF	Ø cm	H cm	📦
P867030	5,8	2,7	12
P867060	7,0	3,7	12
P867090	7,8	4,0	12
P867120	8,5	4,5	12



Mini Black 13

P23840 Mini oval casserole
Mini cacerola oval
Mini casserole ovale



REF	W x D x H cm	L cm	📦
P23840	12 x 8 x 3,5	15,5	96
P23841	21 x 14 x 3,5	26,5	96

P23830 Mini hot plate with handles
Mini parrilla con asas
Mini grill avec poignées



REF	W x D x H cm	L cm	📦
P23830	26 x 16 x 2	32	96

P23825 Mini round fry pan
Mini sartén redonda
Mini poêle ronde



REF	Ø cm	L cm	H cm	📦
P23825	11	16	3,0	96

P23836 Mini round casserole
Mini cacerola redonda
Mini cocotte ronde



REF	Ø cm	L cm	H cm	📦
P23835	11,5	15	3,5	96
P23836	14,5	19	3,5	96

P23824 Mini squared fry pan
Mini sartén cuadrada
Mini poêle carrée



REF	W x D x H cm	L cm	📦
P23824	12,5 x 10,5 x 2	16	96

P23800 Mini round casserole with lid
Mini cacerola con tapa
Mini cocotte avec couvercle



REF	Ø cm	H cm	L cm	📦
P23800	10	6,5	0,25	1
P23810	14	8,0	0,75	1

See colors on
Ver colores en
Voir couleurs
en page

P. 358

13 Mini Black



P23842 Mini casserole
Mini cacerola
Mini cocotte



REF	Ø cm	H cm	
P23842	9	4,5	1

P23843 Mini oval casserole
Mini cacerola oval
Mini cocotte ovale



REF	W x D x H cm	
P23843	18 x 13 x 4	1

P23844 Mini rectangular casserole
Mini cacerola rectangular
Mini casserole rectangulaire



REF	W x D x H cm	
P23844	19,5 x 10 x 5	1

P23845 Mini round fry pan
Mini sartén redonda
Mini poêle ronde



REF	Ø cm	L cm	H cm	
P23845	21,5	30,5	3,0	1

P22120 Snacks or sauce tray
Bandeja snacks o salsas
Plateaux sauces



REF	W x D x H cm	
P22120	17,5 x 8,5 x 3,5	1

P2293 Snacks or sauce tray
Bandeja snacks o salsas
Plateaux sauces



REF	W x D x H cm	
P22920	19 x 8 x 3	12
P22930	9,2 x 6,9 x 3,1	24

Ashtrays 13

Ceniceros
Cendriers



P22035 Squared ashtray. Black
Cenicero cuadrado. Negro
Cendrier carré. Noir



REF	W x D x H cm	
P22035	9 x 9 x 3	1

P22036 Round ashtray. Black
Cenicero redondo. Negro
Cendrier rond. Noir



REF	Ø cm	H cm	
P22036	10	4,5	1

P22030 Windproof ashtray round with lid. Black
Cenicero redondo con tapa. Negro
Cendrier pour l'exterieur avec couvercle. Noir



REF	Ø cm	H cm	
P22030	14,5	6,0	6

P22031 Round dinner ashtray. Black
Cenicero redondo. Negro
Cendrier rond. Noir



BEST SELLER

REF	Ø cm	H cm	
P22031	10	5,0	12

P22185 Conical melamine ashtray. Black
Cenicero cónico melamina. Negro
Cendrier conique. Noir



REF	Ø cm	H cm	
P22185	10	2,7	24

14 Buffet & accessories

Buffet y accesorios

Buffet et accessoires



14.1	DISPLAY STANDS & BASKETS	386
	<i>PRESENTACIÓN Y EXPOSITORES</i>	
	<i>PRÉSENTOIRS ET PRÉSENTOIRS CORBELLES</i>	
14.2	PROTECTION AND COVERS	394
	<i>PROTECCIÓN Y TAPAS / PROTECTION ET COUVERCLES</i>	
14.3	BRONZE COOKWARE	398
	<i>BATERÍA DE COCINA BRONCE / BATTERIE DE CUISINE BRONZE</i>	
14.4	COOL-LINE COLLECTION	400
14.5	SUPERSHAPES	402
	<i>BUFFET PRESENTATION STEAM TABLEPANS</i>	
	<i>CUBETAS PRESENTACIÓN BUFFET / BACS PRÉSENTATION BUFFET</i>	
14.6	MIRAMAR® COOKWARE	406
	<i>BATERÍA DE COCINA PARA PRESENTACIÓN</i>	
	<i>BATTERIE DE CUISINE-PRÉSENTATION</i>	
14.7	CUBIC	412
14.8	CHAFERS & DISPENSERS	428
	<i>CHAFINGS Y DISPENSADORES / CHAFERS ET DISTRIBUTEURS</i>	
14.9	BOWLS & SERVING TRAYS	436
	<i>BOLS & BANDEJAS DE SERVICIO / BOLS & PLATEAUX</i>	
14.10	SERVING TOOLS	440
	<i>UTENSILIOS DE SERVICIO / USTENSILES DE SERVICE BUFFET</i>	
14.11	SIGNS	450
	<i>SEÑALIZACIÓN / SIGNALIZATION</i>	

14.1 Display stands & baskets

Presentación y expositores
Présentoirs et présentoirs corbeilles



NEW!

P598001 One tier flat display stand

Expositor metálico recto de un nivel
Présentoir métallique droit à un niveau



Baskets not included
Cestas no incluidas
Panniers non inclus



REF	W x D x H cm	
P598001	45 x 30 x 20,5	1

P598002 One tier angled display stand

Expositor metálico inclinado de un nivel
Présentoir métallique incliné à un niveau



Baskets not included
Cestas no incluidas
Panniers non inclus



REF	W x D x H cm	
P598002	45 x 30 x 14,5	1

P598003 Three tier flat display stand

Expositor metálico recto de 3 niveles
Présentoir métallique droit 3 niveaux



Baskets not included
Cestas no incluidas
Panniers non inclus



REF	W x D x H cm	
P598003	30 x 24 x 51,5	1

Display stands & baskets 14.1

Presentación y expositores
Présentoirs et présentoirs corbeilles

NEW!

P591006 Rectangular metal wire basket

Cesta metálica rectangular
Panier métallique rectangulaire



Suitable for
Combinable con
Adaptable pour
P598001 / P598002



REF	W x D x H cm	
P591006	45 x 30 x 5	1

P591007 Rectangular metal wire basket

Cesta metálica rectangular
Panier métallique rectangulaire



Suitable for
Combinable con
Adaptable pour
P598003



REF	W x D x H cm	
P591007	30 x 22,5 x 5	1

P595001 Wooden box

Caja de madera
Caisse en bois

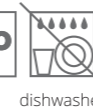

Suitable for
Combinable con
Adaptable pour
P598001 / P598002

Stackable
Apilables
Empilables



REF	W x D x H cm	
P595001	45 x 30 x 5	1
P595002	45 x 30 x 10	1

P595003 Wooden box

Caja de madera
Caisse en bois



Suitable for
Combinable con
Adaptable pour
P598003

Stackable
Apilables
Empilables



REF	W x D x H cm	
P595003	30 x 22 x 5	1
P595004	30 x 22 x 10	1

14.1 Display stands & baskets

Presentación y expositores
Présentoirs et présentoirs corbeilles



NEW!

Available in 3 colours: black, silver and gold in a matt finish.

Stackable.

Suitable for food contact.

Double functionality: tray and riser.

Made from 2 mm thick anodised aluminium providing great strength and toughness.

Disponibles en 3 colores: negro, plata y dorado en acabado mate.

Apilables.

Apta para contacto alimentario.

Doble funcionalidad: bandeja y riser.

Realizado en aluminio adonizado de 2 mm de grosor que ofrece gran robustez y resistencia.

Disponibles en 3 couleurs : noir, argent et doré en finition mate.

Empilables.

Adapté au contact alimentaire.

Double fonctionnalité : plateau et riser.

Fabriqué en aluminium anodisé de 2 mm d'épaisseur, ce qui lui confère une grande robustesse et une grande résistance.

P317500 GN 1/1 buffet tray
Bandeja buffet GN 1/1
Plateau buffet GN 1/1

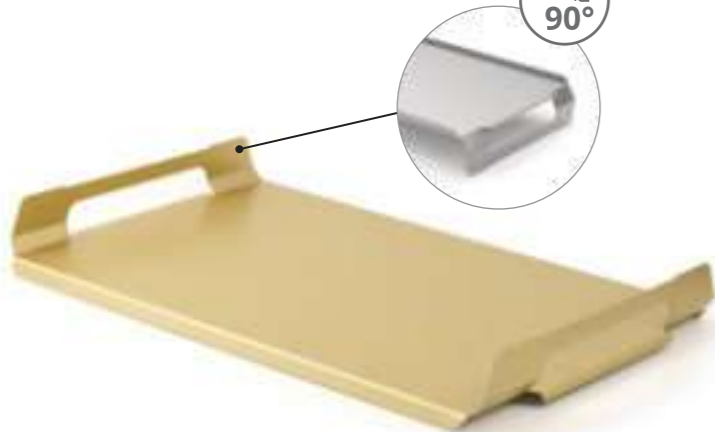

Ref. colour / Ref. color / Ref. couleur couvercle



P317500B / P317500S / P317500G
Adaptable to GN 1/1 trolleys and food transport boxes with guides.

Adaptables a carros GN 1/1 y cajas de transporte de alimentos con guías.

Adaptables aux chariots GN 1/1 et aux caisses de transport de nourriture avec guides.



Click on the top of the handle to stack the trays stable and secure.

Encaje en la parte superior del asa para apilar las bandejas de forma estable y segura.

Enclenchez le dessus de la poignée pour empiler les plateaux de manière stable et sécurisée.

REF	External measures Medidas exteriores Dimensions extérieures W x D x H cm	Usable surface Superficie útil Surface utile cm	
P317500B	53 x 32,5 x 6,5	49,2 x 31	1
P317500S	53 x 32,5 x 6,5	49,2 x 31	1
P317500G	53 x 32,5 x 6,5	49,2 x 31	1

Display stands & baskets 14.1

Presentación y expositores
Présentoirs et présentoirs corbeilles



P317100 Service and buffet trays
Bandejas de servicio y buffet
Plateaux de service et de buffet

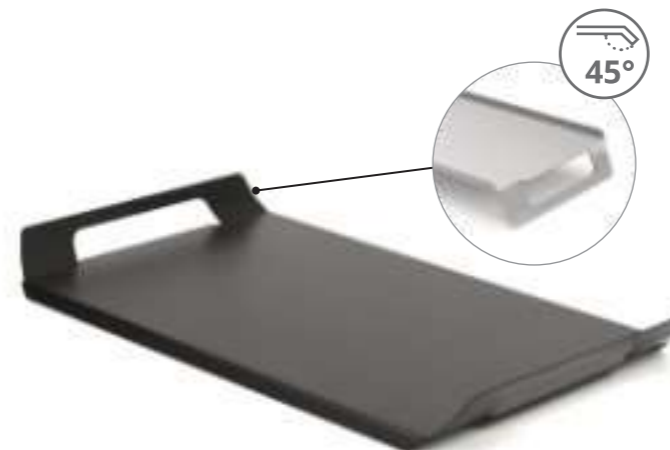

REF	External measures Medidas exteriores Dimensions extérieures W x D x H cm	Usable surface Superficie útil Surface utile cm	
P317100B	53 x 32,5 x 4,6	45,5 x 31	1
P317100S	53 x 32,5 x 4,6	45,5 x 31	1
P317100G	53 x 32,5 x 4,6	45,5 x 31	1

P317200 Service and buffet trays
Bandejas de servicio y buffet
Plateaux de service et de buffet

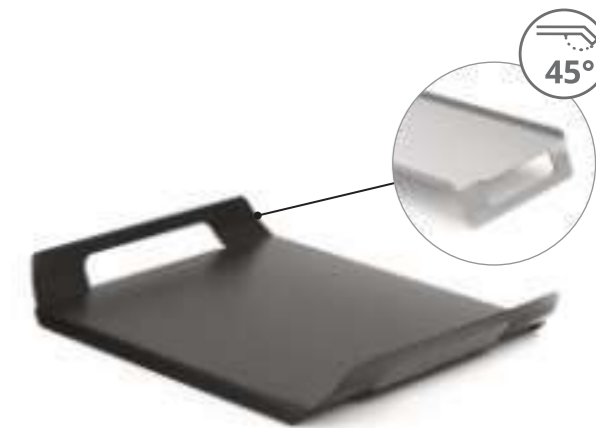

REF	External measures Medidas exteriores Dimensions extérieures W x D x H cm	Usable surface Superficie útil Surface utile cm	
P317200B	43,4 x 32,5 x 4,6	36 x 31	1
P317200S	43,4 x 32,5 x 4,6	36 x 31	1
P317200G	43,4 x 32,5 x 4,6	36 x 31	1

P317300 Service and buffet trays
Bandejas de servicio y buffet
Plateaux de service et de buffet

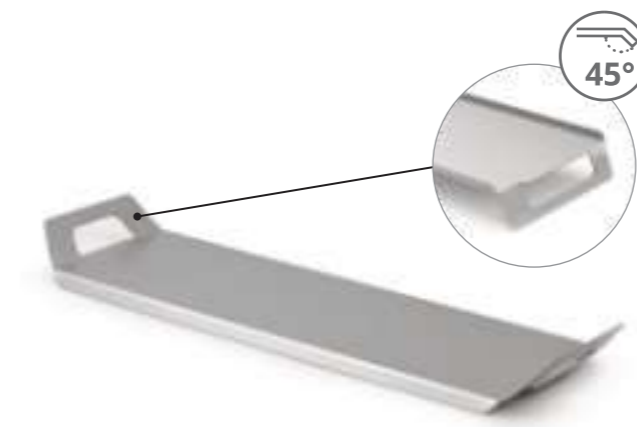

REF	External measures Medidas exteriores Dimensions extérieures W x D x H cm	Usable surface Superficie útil Surface utile cm	
P317300B	51,5 x 18,5 x 4	45,5 x 17	1
P317300S	51,5 x 18,5 x 4	45,5 x 17	1
P317300G	51,5 x 18,5 x 4	45,5 x 17	1

P317400 Service and buffet trays
Bandejas de servicio y buffet
Plateaux de service et de buffet

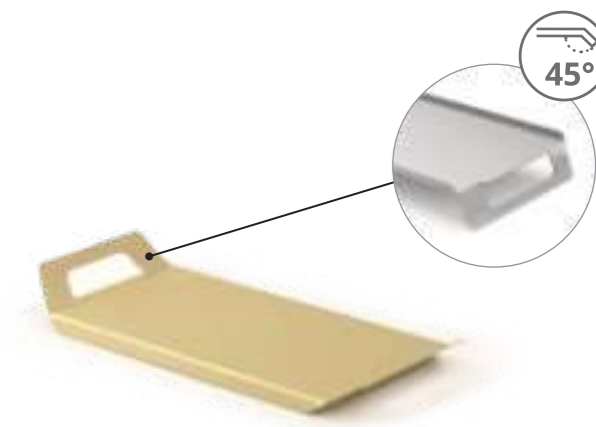

REF	External measures Medidas exteriores Dimensions extérieures W x D x H cm	Usable surface Superficie útil Surface utile cm	
P317400B	39 x 19,5 x 4	33 x 18	1
P317400S	39 x 19,5 x 4	33 x 18	1
P317400G	39 x 19,5 x 4	33 x 18	1

14.1 Display stands & baskets

Presentación y expositores
Présentoirs et présentoirs corbeilles



**BUF
FET**

**BEST
SELLER**



P596110 Black GN wire basket
Cesta rejilla GN negra
Pannier metalique GN noir



1/1

REF	Mod	W x D x H cm	
P596110	1/1	52 x 31,5 x 12	6
P596111	1/1	52 x 31,5 x 16	6

P596120 Black GN wire basket
Cesta rejilla GN negra
Pannier metalique GN noir



1/2

REF	Mod	W x D x H cm	
P596120	1/2	31,5 x 25,5 x 12	6
P596121	1/2	31,5 x 25,5 x 16	6

P596130 Black GN wire basket
Cesta rejilla GN negra
Pannier metalique GN noir



1/3

REF	Mod	W x D x H cm	
P596130	1/3	31,5 x 17 x 12	6
P596131	1/3	31,5 x 17 x 16	6

Suitable for
Compatible con / Adaptable pour



P. 372

P. 373

P. 371

P. 391

Display stands & baskets 14.1

Presentación y expositores
Présentoirs et présentoirs corbeilles



**BUF
FET**

NATURAL
FIBERS



Dos posiciones: derecho y revés.
Two positions: right and reverse.
Deux positions: droit et envers
Zwei Positionen: rechts und rückwärts.



P59511 GN buffet bamboo box
Caja GN bambú buffet
Présentoir GN buffet bambou



1/1

REF	Mod	H cm	
P595110	1/1	10	1
P595111	1/1	20	1

P59512 GN buffet bamboo box
Caja GN bambú buffet
Présentoir GN buffet bambou



1/2

REF	Mod	H cm	
P595120	1/2	10	1
P595121	1/2	20	1

P59513 GN buffet bamboo box
Caja GN bambú buffet
Présentoir GN buffet bambou



1/3

REF	Mod	H cm	
P595130	1/3	10	1
P595131	1/3	20	1

P59510 Tray - Lid for GN buffet bamboo box
Bandeja - Tapa para caja GN bambú buffet
Plateau - Couverture pour présentoir GN buffet bambou



REF	Mod	H cm	
P595100	1/1	2	1
P595200	1/2	2	1
P595300	1/3	2	1

Suitable for
Compatible con / Adaptable pour



P. 371

P. 372

P. 378

P. 397

14.1 Display stands & baskets

Presentación y expositores
Présentoirs et présentoirs corbeilles

Display stands & baskets 14.1

Presentación y expositores
Présentoirs et présentoirs corbeilles



P59711 Buffet displayer
Expositor buffet
Présentoir buffet

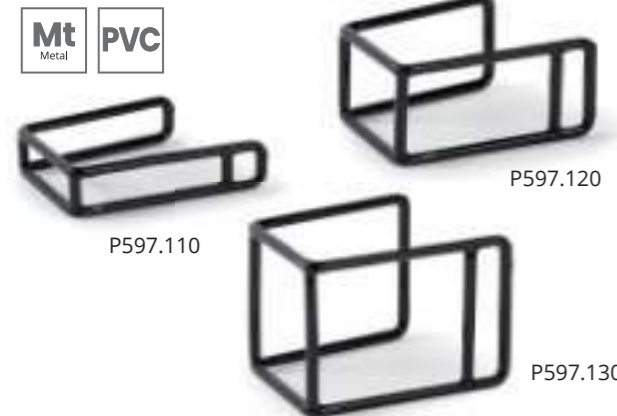

REF	W x D x H cm	
P597110	12,5 x 10,5 x 3	1
P597120	12,5 x 10,5 x 6	1
P597130	12,5 x 10,5 x 9	1

19196 Angled Adaptor Plate
Placa adaptadora angular
Plaque intermédiaire inclinée



Elevates pans to enhance food presentation
Eleva las cubetas para mejorar la presentación de los alimentos
Élévage des bacs pour améliorer la présentation des aliments

REF	W x D x H cm	Type / Tipo	
19196	53 x 32,5 x 7,0	1 GN 1/1 (6°)	2

P597170 Retractable display stand
Expositor buffet extensible
Présentoir buffet rétractable



REF	Max cm	Min cm	H cm Min / Max	
P597170	53 x 32,5	32,5 x 17,6	6,5 / 10	1

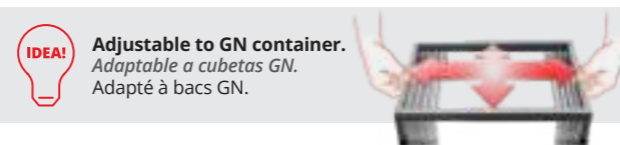

P59714 Buffet displayer
Expositor buffet
Présentoir buffet



REF	Ø A cm	Ø B cm	H cm	
P597140	25	21	10	1
P597150	25	21	20	1
P597160	25	21	30	1

4600960 Set of 3 Square Bent Risers
Juego 3 expositores ángulos redondos
Jeu de 3 socles carrés aux angles arrondis



REF	W x D x H cm	
4600960	(1) 20,3 x 20,3 x 20,3 (2) 20,3 x 19,1 x 15,2 (3) 20,3 x 17,8 x 10,2	1

46009 Set of 3 Square Bent Risers
Juego 3 expositores ángulos redondos
Jeu de 3 socles carrés aux angles arrondis

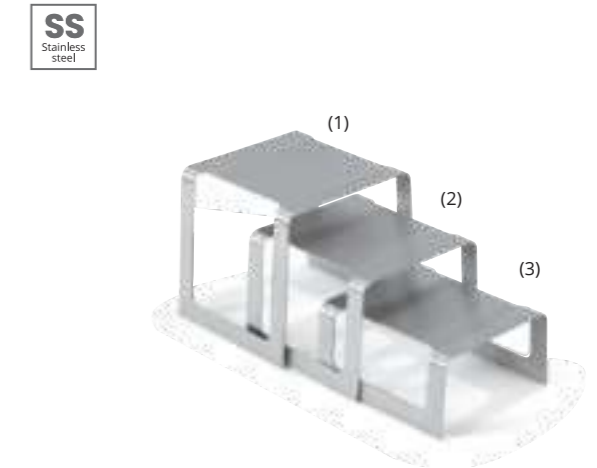

Brushed Stainless Steel
Acero inoxidable pulido
Inox brossé

REF	W x D x H cm	
46009	(1) 20,3 x 20,3 x 20,3 (2) 20,3 x 19,1 x 15,2 (3) 20,3 x 17,8 x 10,2	1

See products on
Ver productos en / Voir produits en page

Round bowl
Bol redondo
Bol rond

P. 363



Display plate
Soporte presentación
Présentoir

P. 373



14.2 Protection and covers

Protección y tapas
Protection et couvercles

P19060 Mobile and ajustable breath guards
Protección Anti-aliendo regulable
Pare-haleine ajustable



REF	W x D x H cm	
P19060	60 x 45 x 38	1
P19090	90 x 45 x 38	1
P19120	120 x 45 x 38	1

Adjustable in tilt and height to adapt to different spaces. Protect exposed foods without losing visibility.

Ajustable en inclinación y altura para adaptarse a diferentes espacios. Protege los alimentos expuestos sin perder visibilidad.

Hauteur et inclinaison réglables pour s'adapter à tous les espaces des buffets. Protège et laisse visible les aliments exposés.

MBA92821 Mobile Acrylic Breath Guards
Protección acrílica Anti-aliendo
Pare-haleine mobiles en acrylique



Bolsa de nylon incluida.
Nylon bag included.
Sac en nylon compris.
Nylontasche nicht enthalten.



REF	W x D x H cm	
MBA92821	121,9 x 49,5 x 40,6	1

Convenient, durable and portable solution to cover food serving areas. Folds down flat and secures with magnetic latches - for ease in transporting. 1 cm thick acrylic panels can be securely fastened in place with easy thumb turns.

Solución para cubrir superficies de alimentos. Paneles acrílicos de 1 cm de grosor. Duradero. De fácil montaje y transporte.

Solution pratique, durable et portable pour couvrir les zones de service des aliments.

Protection and covers 14.2

Protección y tapas
Protection et couvercles

P590008 Dome cover
Tapa campana
Couvercle cloche



REF	Ø cm	H cm	
P590008	21	17,5	1
P590009	26	20,0	1
P590010	31	23,5	1



Fitting system with the base that provides stability

Sistema de encaje con la base que aporta estabilidad

Système d'assemblage avec la base qui assure la stabilité



P22361 Display tray
Bandeja presentación
Plateau présentation



REF	Ø cm	H cm	
P22361	22,7	1,5	1
P22362	27,8	1,5	1
P22363	32,7	1,5	1

P2236 Stand
Stan
Base



Suitable for
Combinable con
Adaptable pour

P22361 / P22362 / P22363

REF	Ø cm	H cm	
P22366	16,5	10	1
P22367	16,5	18	1

NEW!

P590011 Hinged cover
Tapa con visagra
Couvercle articulé



REF	Ø cm	
P590011	23,0	1
P590012	26,5	1

P22364 Bowl
Bol
Bol



REF	Ø cm	
P22364	22,5	1
P22365	26,0	1



IDEA! P590008 + P22361
P590009 + P22362
P590010 + P22363



IDEA! P590011 + P22364
P590012 + P22365

14.2 Protection and covers

Protección y tapas
Protection et couvercles



P598700 Clear round lid for presentation
Tapa redonda transparente presentación
Couvercle rond transparent pour présentation



REF	Ø cm	H cm	
P598700	22	13,5	1
P598800	27	16,5	1

P590005 Round display cabinet
Vitrina redonda
Vitrine ronde



REF	Ø cm	H cm	Base útil / Functional basic Base utile Ø cm	
P590005	38	22	31,5	1
P590006	46	26	37,5	1

P590001 Rectangular display cabinet
Vitrina rectangular
Vitrine rectangulaire



REF	W x D x H cm	Base útil / Functional basic Base utile Ø cm	
P590001	40 x 24,5 x 15,5	34 x 19	1
P590002	50,5 x 30,5 x 18	44 x 24,5	1

P590003 Double display cabinet
Vitrina doble
Vitrine double



REF	W x D x H cm	Base útil / Functional basic Base utile Ø cm	
P590003	40 x 24,5 x 32	2 x (34 x 19)	1
P590004	50,5 x 30,5 x 40	2 x (44 x 24,5)	1

Protection and covers 14.2

Protección y tapas
Protection et couvercles



P904300 Roll-top lid
Tapa roll-top
Couvercle roll-top

1/1



REF	Mod	W x D x H cm	
P904300	1/1	57 x 32,5 x 17,5	1

P590110 Clear GN lids for presentation
Tapas GN transparentes presentación
Couvercles GN transparentes de présentation



P834 GN prectangular lid
Tapa rectangular GN
Couvercle rectangulaire GN

1/1



REF	Mod	W x D x H cm	
P834000	1/1	53 x 32,5 x 10	6

P835 GN dome lid
Campana GN
Dôme de protection GN

1/1



REF	Mod	W x D x H cm	
P835000	1/1	53 x 32,5 x 19	6

Suitable for
Compatible con / Adaptable pour **P. 391**



14.3 Bronze cookware

Batería cocina bronce
Batterie de cuisine bronze



Transparent glass lid with stainless steel rim and black handle.

Tapa de cristal transparente con borde de acero inoxidable y mango en color negro.

Couvercle en verre transparent avec rebord en acier inoxydable et manche noir.

Escape valve for steam

Válvula de salida de vapor
Clapet de sortie de la vapeur

Exterior painted in an elegant bronze colour.

Exterior pintado en elegante color bronce.

Extérieur avec revêtement bronze élégant.

Made of cast aluminium with high resistance to deformation and excellent thermal performance.

Fabricada en aluminio de fundición de gran resistencia a la deformación y con excelentes prestaciones térmicas.

Fabriqué en fonte d'aluminium très résistante à la déformation et doté d'excellentes performances techniques.

Ground base

Fondo torneado
Fond dressé

Elegant, robust, versatile

Elegante, robusta, versátil / Élégante, solide, polyvalente



Bronze cookware 14.3

Batería cocina bronce
Batterie de cuisine bronze

P1520 Rotisserie
Rustidera
Plat à rôtir



REF	W x D x H cm	
P152035B	35 x 25 x 7,5	1
P152935	Transparent lid Tapa transparente / Couvercle transparent	1

P1410 Shallow casserole without lid
Cazuela baja sin tapa
Cocotte sans couvercle



REF	Ø cm	H cm	
P141024B	24	5,8	1
P141028B	28	7,5	1
P141032B	32	8,0	1

P1510 Deep casserole without lid
Cazuela alta sin tapa
Braising sans couvercle



REF	Ø cm	H cm	
P151020B	20	9	1
P151024B	24	10	1
P151028B	28	12	1

P1540 Glass lid with stainless steel rim
Tapa de cristal con borde de acero inoxidable
Couvercle en verre avec rebord en acier inoxydable



REF	Ø cm	
P154020	20	1
P154024	24	1
P154028	28	1
P154032	32	1

14.4 Cool-line

IDEA! Ideal for hot buffet
Ideal para buffet caliente
Idéal pour buffet chaud

P1311 Enamelled steel GN container
Cubeta GN de acero esmaltado
Bac GN en acier émaillé

NEW!



Suitable for all types of temperature-maintaining plates.
Apto para todo tipo de placa mantenedora de temperatura.
Convient à tous types de plaques de maintien en température.

REF	Type Tipo	H cm	☐
P131120	1/1	2,0	1
P131165	1/1	6,5	1
P131220	1/2	2,0	1
P131265	1/2	6,5	1



P4909 Paella pan with lid
Paellera con tapa
Plat à paella avec couvercle



EXCLUSIVE



Ref. colour / Ref. color / Ref. couleur couvercle



REF	Ø cm	H cm	Lts	☐
P490928 + COLOR	28	6	3,7	1
P490932 + COLOR	32	6	4,7	1

See products on
Ver productos en / Voir produits en page **P. 54**

Cookware
Batería de cocina
Batterie de cuisine



See products on
Ver productos en / Voir produits en page **P. 71**

Fry pans
Sartenes
Poêles



Cool-line 14.4



P1106F3 Non-stick sandwich bottom GN container
Cubeta GN antiadherente con fondo difusor
Bac GN anti-adhésive avec fond thermo-diffuseur

PATENTED EXCLUSIVE



IDEA! Ideal for buffet presentations.
Ideal para presentación buffet.
Idéal pour présentation buffet.

Ref	Type Tipo	H mm	Lts	☐
P1106F3A	1/1	6,5	8,30	1
P1106F3N	1/1	6,5	8,30	1
P1106F3R	1/1	6,5	8,30	1
P1106F3G	1/1	6,5	8,30	1
P1106F3	1/1	6,5	8,30	1
P1206F3A	1/2	6,5	4,10	1
P1206F3N	1/2	6,5	4,10	1
P1206F3R	1/2	6,5	4,10	1
P1206F3G	1/2	6,5	4,10	1
P1206F3	1/2	6,5	4,10	1

P1106F3A



Ref. colour / Ref. color / Ref. couleur couvercle



P1106F3R



P1106F3N



P1106F3



P1106F3G



BUFFETACCESSORIES
BUFFETACCESSORIES
BUFFETACCESSORIES

BUFFETACCESSORIES
BUFFETACCESSORIES
BUFFETACCESSORIES

14.5 Super shapes

Buffet presentation steam table pans
Cubetas presentación buffet / Bacs présentation buffet



PATENTED **EXCLUSIVE**

Presentation of food in chafers, heated or refrigerated buffet lines, display cases, and more.

Presentación de las comidas en chafers, líneas buffet calientes o fríos, vitrinas de presentación y más.

Présentation des plats dans les chafers, les lignes de buffet chauffées ou réfrigérées, les présentoirs et bien plus encore.

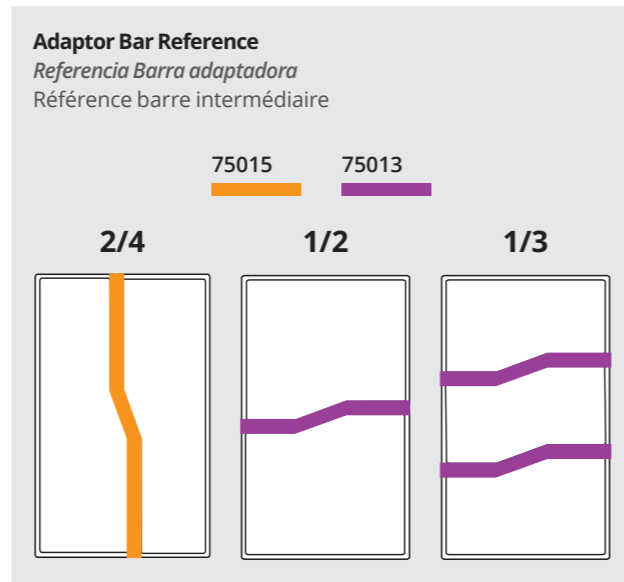

Stackable
Apilable
Empilable



Super shapes 14.5

Buffet presentation steam table pans
Cubetas presentación buffet / Bacs présentation buffet



3101015 Full Oval
Ovalada
Ovale



1/1



REF	W x D x H cm	L	
3101015	53 x 32,5 x 5,1	3,7	6
3101020	53 x 32,5 x 6,5	4,6	6
3101040	53 x 32,5 x 10	7,8	6

3102015 Half Oval
Óvalo
Ovale



1/2

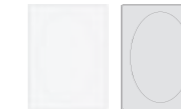

REF	cm	L	
3102015	26,5 x 32,5 x 5,1	1,6	6
3102020	26,5 x 32,5 x 6,5	2,1	6
3102040	26,5 x 32,5 x 10	3,5	6

3101220 Full Hexagon
Hexágono
Hexagonal



1/1



REF	W x D x H cm	L	
3101220	53 x 32,5 x 6,5	5,0	6
3101240	53 x 32,5 x 10	8,8	6

3102220 Full Hexagon
Hexágono
Hexagonal



1/2



REF	W x D x H cm	L	
3102220	26,5 x 32,5 x 6,5	2,1	6

3101120 Full Kidney
Reniforme
Rein



1/1



REF	W x D x H cm	L	
3101120	53 x 32,5 x 6,5	4,8	6

14.5 Super shapes

Buffet presentation steam table pans
Cubetas presentación buffet / Bacs présentation buffet



3102120 Half Kidney
Reniforme
Rein



1/2



REF	W x D x H cm	L	
3102120	26,5 x 32,5 x 6,5	2,1	6

3100020 Long Wild Pan
Wild Pan larga
Wild Pan long



2/4



75015

REF	W x D x H cm	L	
3100020	53 x 16,5 x 6,5	3,5	6
3100040	53 x 16,5 x 8,9	4,8	6

3100220 Short Wild Pan
Wild Pan corta
Wild Pan court



1/2



75013

REF	W x D x H cm	L	
3100220	26,5 x 32,5 x 6,5	3,9	6
3100240	26,5 x 32,5 x 10	6,1	6

3100320 Third Outer Wild Pan
Wild Pan externa
Troisième Wild Pan extérieur



1/3



75013

REF	W x D x H cm	L	
3100320	17,6 x 32,5 x 6,5	2,5	6
3100340	17,6 x 32,5 x 10	3,6	6

3100321 Inner Wild Pan
Wild Pan interna
Troisième Wild Pan intérieur



1/3



75013

REF	W x D x H cm	L	
3100321	17,6 x 32,5 x 6,5	2,5	6
3100341	17,6 x 32,5 x 10	3,6	6

75015 Adaptor Bar
Barra adaptadora
Barre intermédiaire



REF	For / Para / Pour	
75015	3100020 / 3100040	12
75013	3100220 / 3100240 / 3100320 3100321 / 3100340 / 3100341	12

See products on / Ver productos en / Voir produits en page

P. 194

GN St/steel



See products on / Ver productos en / Voir produits en page

P. 203

POLINORM®



14.6 Miramar ®cookware

Batería de cocina para presentación
Batterie de cuisine-Présentation



Cookware goes straight from the kitchen to your buffet in the same vessel.

Variety of cookware items or any menu.

La batería pasa directamente de la cocina a su buffet en el mismo recipiente.

Variación de utensilios de cocina para todo tipo de comidas.

Passez directement de la cuisine au buffet sans changer de plat.
Variété d'articles pour tout type de menu.

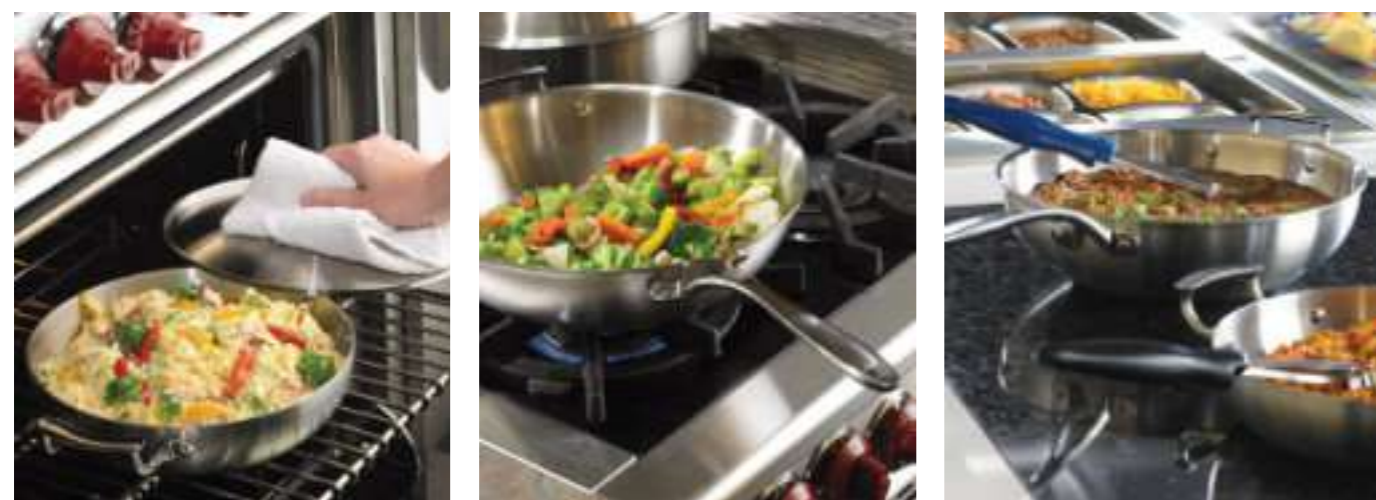

Miramar ®cookware 14.6

Batería de cocina para presentación
Batterie de cuisine-Présentation



Satin-finished interior and exterior

Asas y mangos brillantes
Des poignées ultra-brillantes

Handle design serves as a convenient cover rest

Mangos diseñados para la sujeción de las tapas
La conception des manches et poignées sert de reposecouvercle

Mirror-finished handles

Interior y exterior satinados
Finition satinée à l'intérieur et l'extérieur



Multi-ply
Multimetal
Multi-metal

St/Steel - Inox

Tri-aluminium

St/Steel - Inox

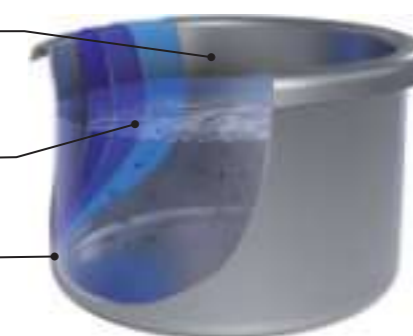

14.6 Miramar® cookware

Batería de cocina para presentación
Batterie de cuisine-Présentation



49410 Casseroles
Cacerola baja con tapa
Faitouts avec couvercle dôme bas



REF	Ø cm	H cm	L	
49410	20,0	9,5	2,9	1
49411	24,1	11,3	4,8	1
49441	25,8	18,9	6,6	1 NEW

49425 Bazier pan
Cacerola baja
Plat à braiser



REF	Ø cm	H cm	L	
49425	30	8,9	6	1

49413 Sauté Pan
Sartén
Sauteuse



REF	Ø cm	H cm	L	
49416	20,3	5,1	1,2	1 NEW
49413	26,0	4,8	2,1	1

49417 French Omelet Pans
Paellera
Poêle à omelette



REF	cm	H cm	L	
49417	20,3 x 20,3	6	1,7	1
49424	26 x 26	6	2,9	1

49418 Stir Fry Pan
Sautex bombeado
Wok/plat de service



REF	Ø cm	H cm	L	
49418	30,2	9,4	4,9	1
49428	32,1	9,2	6,0	1

49430 Sauce Pans
Cazo
Casserole



REF	Ø cm	H cm	L	
49414	15,9	9,5	1,9	1
49430	14,0	6,8	0,9	1 NEW

Miramar® cookware 14.6

Batería de cocina para presentación
Batterie de cuisine-Présentation



49432 Food Pans
Fuente
Plat



REF	W x D x H cm	L	
49432	37,3 x 30 x 5,1	4,4	1 NEW
49435	29,1 x 23,6 x 5,1	2,6	1
49433	37,3 x 30 x 5,1	4,4	1

49431 French Oven with cover
Fuente Horno con tapa
Cocotte avec couvercle



REF	W x D x H cm	L	
49431	363 x 282 x 9,7	6,6	1

8230210 Oval presentation dish
Fuente presentación ovalada
Fontaine de présentation ovale



REF	W x D x H cm	L	
8230210	33,3 x 22,5 x 6,4	1,9	1
8231420	48,4 x 30,2 x 5,1	2,8	1

49420 Oval Au Gratin
Fuente para gratinar
Plat à gratin ovale



* Mirror-finished interior
Acabado brillante
Ultra-brillante

REF	W x D x H cm	L	
49420	25,4 x 19,1 x 5,2	1,7	1
49412*	30,5 x 21,6 x 5,1	2,5	1
49442	40,6 x 22,9 x 5,1	3,5	1 NEW
49445	52,3 x 22,9 x 10,2	6,6	1 NEW

49429 Covers
Tapa
Couvercles



REF	For / Para / Pour	Ø cm	H mm	
49429	49428	35,6	120	1
49426	49418 - 49425	32,4	102	1
49419	49416 - 49417	20,3	51	1
49423	49413 - 49424	27,3	51	1
49427	49430	14,9	51	1 NEW

8231810 Rectangular presentation dish
Fuente presentación rectangular
Fontaine de présentation rectangulaire



REF	W x D x H cm	L	
8231810	33,2 x 27 x 2,5	1,5	1
8230720	33,2 x 27 x 7	3,2	1

14.6 Miramar®cookware

Batería de cocina para presentación
Batterie de cuisine-Présentation

TEMPLATES
PLANTILLAS
GABARITS

Stainless Steel Plain / Acero inox. / Inox
Resin / Resina / Résine
Night Sky / Negro / Bleu nuit

+150°C



8242014 One large and one small round
Plantilla agujeros redondo grande y pequeño
Une grande découpe ronde et une petite découpe ronde



REF	cm		
8242014	53,6 x 32,4		1
8242010	53,6 x 32,4		1

8242314 One large oval
Plantilla agujero oval grande
Une grande découpe ovale



REF	cm		
8242314	53,6 x 32,4		1
8242310	53,6 x 32,4		1

8242414 One large round and one small round
Plantilla agujeros redondo grande y pequeño
Une grande découpe ronde et une petite découpe ronde



REF	cm		
8242414	53,6 x 32,4		1

8242514 Two large round
Plantilla agujeros redondos grandes
2 grandes découpes rondes



REF	cm		
8242514	53,6 x 32,4		1

8242614 One large round
Plantilla agujero redondo grande
Une grande découpe ronde



REF	cm		
8242614	53,6 x 32,4		1
8242610	53,6 x 32,4		1

8242714 One large oval
Plantilla agujero oval grande
Un grand ovale

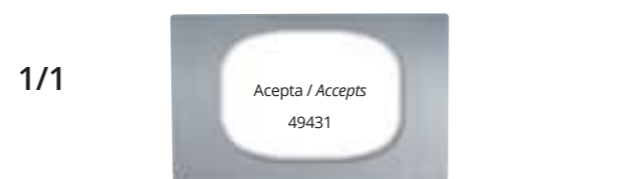

REF	cm		
8242714	53,6 x 32,4		1
8242710	53,6 x 32,4		1

Miramar®cookware 14.6

Batería de cocina para presentación
Batterie de cuisine-Présentation

+150°C

8240016 Solid baseplate
Plantilla sólida
Modèle solide



1/1



REF	cm		
8240016	53,6 x 32,4		1

8242814 One small food pan
Plantilla para fuente
Un petit bac à aliments

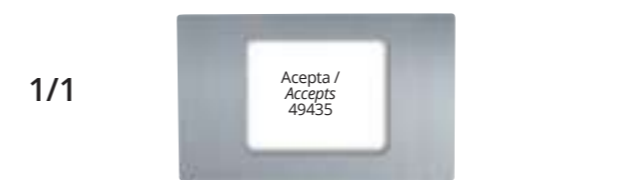

REF	cm		
8242814	53,6 x 32,4		1
8242810	53,6 x 32,4		1

8242914 One large food pan
Plantilla para fuente
Un grand bac à aliments

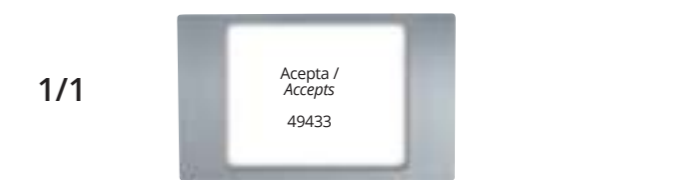

REF	cm		
8242914	53,6 x 32,4		1

8243014 Two small food pans
Plantilla para fuente
Deux petits bacs à aliments



REF	cm		
8243014	53,6 x 32,4		1

8243114 One large and one medium oval
Plantilla agujeros ovales grande y pequeño
Une grande découpe ronde et une moyenne découpe ovale



REF	cm		
8243114	53,6 x 32,4		1

8243214 Two medium oval
Plantilla agujeros redondos medianos
Deux découpes ovales moyennes



REF	cm		
8243214	53,6 x 32,4		1
8243210	53,6 x 32,4		1

14.7 CUBIC®

EXCLUSIVE

PATENT PENDING

Modularity that reflects maximum expression
Modularidad a la máxima expresión
Modularité à son expression maximale

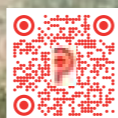

Discover the best buffet display, thanks to its:

- It allows to optimize exhibition space
- It reduces assembly and disassembly time
- Ease of transport and storage
- Elegant and original
- It offers multiple and varied combinations

Descubre la mejor presentación de buffet, porque:

- *Permite optimizar espacio de exposición*
- *Reduce el tiempo de montaje y desmontaje*
- *Facilidad de transporte y almacenaje*
- *Elegante y original*
- *Ofrece múltiples y variadas combinaciones*

Découvrez la meilleure présentation buffet, grâce à son :

- Permet d'optimiser l'espace d'exposition
- Réduit le temps de montage et de démontage
- Facilité de transport et de stockage
- Élégant et original
- Offre des combinaisons multiples et variées



CUBES / CUBO / CUBES

Top cover convertible on mini shelf, stackable, multicombinations, saving space when storing parts, special waterproof treatment.

Con tapa superior transformable en mini estante, apilables entre sí, múltiples combinaciones posibles, ahorro de espacio durante el almacenaje de las piezas, tratamiento hidrófugo especial.

Couvercle transformable en mini rayon, empilables, multiples combinaisons possibles, gain d'espace pour le stockage des composants, traitement hydrofuge spécial.

SHELVES / ESTANTES / TABLETTES

Three lengths: 50, 80 and 100 cm, two depths: 18 and 35 cm, undeformable wood. Special waterproof treatment.

Tres longitudes: 50, 80 y 100 cm, dos profundidades: 18 y 35 cm, madera indeformable. Tratamiento hidrófugo especial.

Trois longueurs: 50, 80 et 100 cm, deux profondeurs: 18 et 35 cm. Bois indéformable. Traitement hydrofuge spécial.



Stackable trays
Bandejas apilables entre sí
Plateaux empilables entre eux

Display buffet cases Muebles presentación buffet Meubles présentation buffet

Suitable for gastronorm sizes
Adaptado a medidas gastronorm
Adaptés aux mesures gastronorme

Made of wood with special waterproof treatment, easy to clean

Fabricados en madera con tratamiento hidrófugo especial, de fácil limpieza

Fabriqué en bois avec un traitement hydrofuge spécial, facile à nettoyer



Wooden buffet serving trolley Carro madera presentación buffet Chariot buffet en bois présentation buffet

Outstanding combination of wood and aluminium
Elegante combinación de madera y aluminio
Combinaison élégante en bois et en aluminium

Suitable for gastronorm sizes
Adaptado a medidas gastronorm
Adaptés aux mesures gastronorme

Possible transformation from an exposer trolley to a presentation table

Posibilidad de convertir el carro expositor en mesa de presentación

Possibilité de transformer le chariot d'exposition en une table de présentation

Wood with special waterproof treatment, easy to clean
Tratamiento hidrófugo especial, de fácil limpieza
Bois avec un traitement hydrofuge spécial, facile à nettoyer



P905504 Presentation kit for 4 square bowls
Conjunto soporte 4 bols cuadrados
Kit support 4 bols carrés

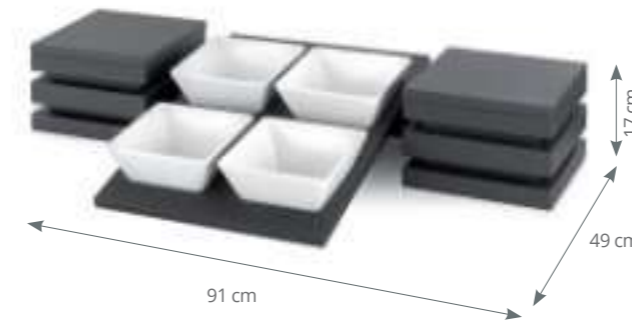

Includes :
2 cubes with lid
1 crossbar 50 cm length
1 displayer for 4 bowls
4 melamine bowls.

Incluye:
2 cubos con tapa
1 travesaño de 50 cm
1 presentador de 4 bols
4 bols de melamina.

Inclus :
2 cubes avec couvercle
1 longeron 50 cm
1 présentoir pour 4 bols
4 bols mélamine.

REF P905504  1

P905506 Presentation kit for 6 square bowls
Conjunto soporte 6 bols cuadrados
Kit support 6 bols carrés



Includes :
2 cubes with lid
1 crossbar 100 cm length
1 displayer for 6 bowls
6 melamine bowls.

Incluye:
2 cubos con tapa
1 travesaño de 100 cm
1 presentador de 6 bols
6 bols de melamina.

Inclus :
2 cubes avec couvercle
1 longeron 100 cm
1 présentoir pour 6 bols
6 bols mélamine.

REF P905506  1

P905516 Two levels presentation kit for 6 square bowls
Conjunto 2 niveles soporte 6 bols
Kit support 6 bols carrés deux niveaux



Includes :
4 cubes with lid
1 crossbar 100 cm length
1 displayer for 6 bowls
6 melamine bowls
1 narrow shelf 100 cm

Incluye:
4 cubos con tapa
1 travesaño de 100 cm
1 presentador de 6 bols
6 bols de melamina
1 estante estrecho de 100 cm

Inclus :
4 cubes avec couvercle
1 longeron 100 cm
1 présentoir pour 6 bols
6 bols mélamine
1 tablette étroite 100 cm

REF P905516  1

P905508 Presentation kit for 8 square bowls
Conjunto soporte 8 bols cuadrados
Kit support 8 bols carrés



Includes :
2 cubes with lid
1 crossbar 80 cm length
2 displayers for 4 bowls
8 melamine bowls

Incluye:
2 cubos con tapa
1 travesaño de 80 cm
2 presentadores de 4 bols
8 bols de melamina

Inclus :
2 cubes avec couvercle
1 longeron 80 cm
2 présentoirs pour 4 bols
8 bols mélamine

REF P905508  1

P905518 Two levels presentation kit for 8 square bowls

Conjunto 2 niveles soporte 8 bols
Kit support 8 bols carrés deux niveaux



Includes :
4 cubes with lid
1 crossbar 80 cm length
2 displayers for 4 bowls
8 melamine bowls
1 narrow shelf 80 cm

Incluye:
4 cubos con tapa
1 travesaño 80 cm
2 presentadores de 4 bols
8 bols de melamina
1 estante estrecho 80 cm

Inclus :
4 cubes avec couvercle
1 longeron 80 cm
2 présentoirs pour 4 bols
8 bols mélamine
1 tablette étroite 80 cm

REF 1
P905518

P905400 Basic two levels presentation kit

Conjunto básico estante 2 niveles
Kit basique présentation 2 niveaux



Includes :
4 cubes with lid
1 wide shelf 100 cm
1 narrow shelf 100 cm

Incluye:
4 cubos con tapa
1 estante ancho 100 cm
1 estante estrecho 100 cm

Inclus :
4 cubes avec couvercle
1 tablette large 100 cm
1 tablette étroite 100 cm

REF 1
P905400

P905310 Two levels presentation kit for 40x40 cm trays

Conjunto 2 niveles bandejas 40x40 cm
Kit présentation 2 niveaux pour plateaux 40x40 cm



Includes :
6 cubes with lid
1 crossbar 100 cm length
2 serving trays 40 x 40 cm
1 narrow shelf 100 cm

Incluye:
6 cubos con tapa
1 travesaño de 100 cm
2 bandejas presentación de 40 x 40 cm
1 estante estrecho de 100 cm

Inclus :
6 cubes avec couvercle
1 longeron 100 cm
2 plateaux présentation 40 x 40 cm
1 tablette étroite 100 cm

REF 1
P905310

P905320 Two trays 60x40 cm presentation kit

Conjunto 2 bandejas 60x40 cm
Kit présentation pour deux plateaux 60x40 cm



Includes :
2 cubes with lid
1 crossbar 100 cm length
2 serving trays 60 x 40 cm

Incluye:
2 cubos con tapa
1 travesaño de 100 cm
2 bandejas presentación de 60 x 40 cm

Inclus :
2 cubes avec couvercle
1 longeron 100 cm
2 plateaux présentation 60 x 40 cm

REF 1
P905320

P905410 "L" shape two levels presentation kit

Conjunto estante dos niveles forma "L"
Kit présentation "L" 2 niveaux

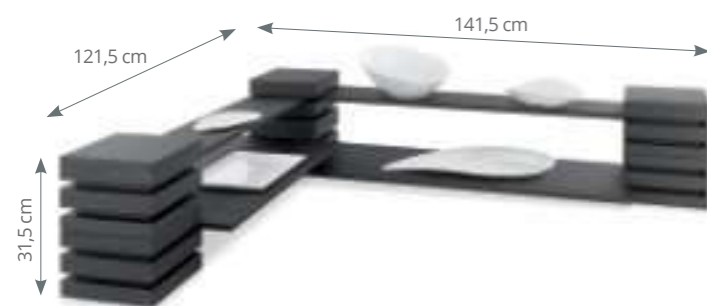

Includes :
6 cubes with lid
1 wide shelf 100 cm
1 narrow shelf 100 cm
1 wide shelf 80 cm
1 narrow shelf 80 cm

Incluye:
6 cubos con tapa
1 estante ancho 100 cm
1 estante estrecho 100 cm
1 estante ancho 80 cm
1 estante estrecho 80 cm

Inclus :
6 cubes avec couvercle
1 tablette large 100 cm
1 tablette étroite 100 cm
1 tablette large 80 cm
1 tablette étroite 80 cm

REF 1
P905410

P905300 Two trays 40x40 cm presentation kit

Conjunto 2 bandejas presentación 40x40 cm
Kit présentation pour deux plateaux 40x40 cm



Includes :
4 cubes with lid
1 crossbar 100 cm length
2 serving trays 40 x 40 cm

Incluye:
4 cubos con tapa
1 travesaño de 100 cm
2 bandejas presentación de 40 x 40 cm

Inclus :
4 cubes avec couvercle
1 longeron 100 cm
2 plateaux présentation 40 x 40 cm

REF 1
P905300

P905340 Two levels for trays 60x40 cm presentation kit

Conjunto 2 niveles para bandejas 60x40 cm
Kit présentation 2 niveaux pour plateaux 60x40 cm



Includes :
6 cubes with tapa
1 travesaño de 100 cm
2 bandejas presentación de 60 x 40 cm
1 estante estrecho de 100 cm

Incluye:
6 cubos con tapa
1 travesaño de 100 cm
2 bandejas presentación de 60 x 40 cm
1 estante estrecho de 100 cm

Inclus :
6 cubes avec couvercle
1 longeron 100 cm
2 plateaux présentation 60 x 40 cm
1 tablette étroite 100 cm

REF 1
P905340

P904790 Three levels 2/3 GN stand

Expositor GN 2/3, tres niveles
Présentoir 3 niveaux pour GN 2/3



Includes / Incluye / Inclus :
3 GN containers 2/3 20 mm
3 cubetas GN 2/3 20 mm
3 bags GN 2/3 20 mm

REF **W x D x H cm** 1
P904790 65 x 38 x 59

P904350 GN skewer serving tray
Bandeja GN presentación pinchos
Plateau GN présentation piques



GN 1/1

Includes:
wooden tray
oak melamine tray
interior skewer stand

Incluye:
bandeja madera
bandeja melamina roble
soporte interior pinchos

Inclus:
plateau bois
plateau mélamine chêne
support intérieur piques

REF	W x D x H cm	Holes Agujeros Ø cm	Piques Pinchos	
P904350	53,9 x 33,5 x 7,7	0,4	84	1

P904155 Buffet wine cooler
Enfriador botellas buffet
Rafráichisseur bouteilles



GN 1/1

Includes:
wooden tray
1/1 GN pan 150 mm

Incluye:
bandeja madera
cubeta GN 1/1 150 mm

Inclus:
plateau bois
bac GN 1/1 150 mm

REF	W x D x H cm	
P904155	57 x 37 x 14,5	1

P904850 1/1 GN wooden table + cutting board
Mesita buffet GN 1/1 + taco madera
Table GN 1/1 en bois + planche à découper



REF	W x D x H cm	
P904850	53 x 32,5 x 12	1

P904810 Low wooden table + cutting board
Mesita buffet baja + taco madera
Table basse en bois + planche à découper



REF	W x D x H cm	
P904810	32,5 x 22 x 12	1
P904820	32,5 x 22 x 16,5	1

P904804 Cutting board for wooden table
Taco madera para mesita buffet
Planche à découper pour table en bois



REF	W x D x H cm	
P904804 ¹	29,2 x 18,7 x 22	1
P904809 ²	49,7 x 29,2 x 22	1

(1) For / Para / Pour P904810 / P904820
(2) For / Para / Pour P904850

P904720 Napkin and tea & sugar bags dispenser
Servilletero y dispensador bolsas te y azúcar
Distributeur serviettes et des saquettes
thé & sucre



REF	W x D x H cm	
P904720	22 x 22 x 5,5	1
P904725	22 x 22 x 5,5	1

P904721 Tea & sugar bag holder
Soporte bolsas te y azúcar
Support pour saquettes de thé & sucre



For / Para / Pour ref. P904.720

REF	W x D x H cm	
P904721	19,8 x 19,8 x 4,9	1

P20072 Methacrylate holder
Portamenús metacrilato
Porte-menus méthacrylate



REF	cm	
P20072	6 x 6	1



See products on / Ver productos en / Voir produits en page

P. 485

Stainless steel plate covers
Tapas Acero inoxidable para platos
Inox couvercles à assiette





ROOM SERVICE

P904780 Cutlery-holder tray
Bandeja porta-cubiertos
Plateau porte-couverts



GN 1/1



Stackables.
Apilables.
Empilables.

4 compartments
4 compartimentos
4 compartiments
303 x 115 mm

REF	W x D x H cm	
P904780	53,9 x 33,5 x 7,7	1

P904740 Serving tray
Bandeja presentación
Plateau présentation



Stackables.
Apilables.
Empilables.

REF	W x D x H cm	
P904740	40 x 40 x 6,5	1

P904760 Serving tray
Bandeja servicio y presentación
Plateau service et présentation



Stackables.
Apilables.
Empilables.



Room service tray.
Perfecta para servicio de habitaciones.
Plateau idéal pour service de chambre.

REF	W x D x H cm	
P904760	60 x 40 x 6,5	1

P904711 1/1 GN serving tray
Bandeja servicio y presentación GN 1/1
Plateau service et présentation GN 1/1



GN 1/1

Stackables.
Apilables.
Empilables.

1/1 Gastronorm container not included.
No incluye cubeta gastronorm 1/1.
Bac gastronorme 1/1 non inclus.

REF	W x D x H cm	
P904711	53,9 x 33,5 x 7,7	1

P904600 Wooden cube with lid
Cubo con tapa madera
Cube en bois avec couvercle

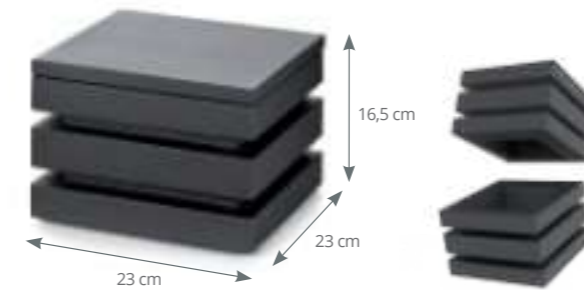

REF		
P904600		1

P904660 Wooden lid
Tapa madera
Couvercle en bois



REF		
P904660		1

P904650 Wooden narrow shelf
Estante madera estrecho
Tablette en bois étroite

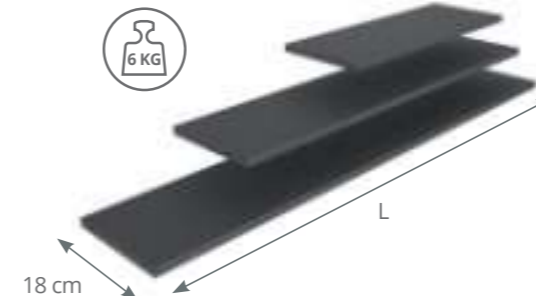

REF	L cm	
P904650	50	1
P904680	80	1
P904610	100	1

P904652 Wooden wide shelf
Estante madera ancho
Tablette en bois large

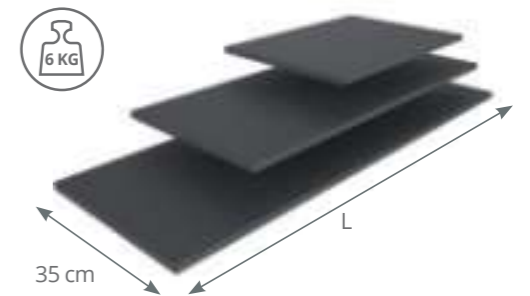

REF	L cm	
P904652	50	1
P904682	80	1
P904612	100	1

P904937 Displayer for 4 melamine bowls
Presentador 4 bols melamina cuadrados
Présentoir 4 bols mélamine

For square bowls
Para bols cuadrados
Pour bols carrés
180 x 180
REF. P22.202



REF	W x D x H cm	
P904937	37,5 x 50 x 1,5	1

P904975 Displayer for 6 melamine bowls
Presentador 6 bols melamina cuadrados
Présentoir 6 bols mélamine

For square bowls
Para bols cuadrados
Pour bols carrés
180 x 180
REF. P22.202



REF	W x D x H cm	
P904975	75 x 50 x 1,5	1

P904950 Crossbar buffet trays
Travesaño soporte bandejas
Longerons pour plateaux buffet



P904165 Perforated buffet display
Buffet perforado
Buffet perforé



Includes: Wooden frame perforated 1/1 GN pan 65 mm gastronorm pan 1/1 20 mm roll-top lid.
Incluye: Marco madera bandeja perforada GN 1/1 65 mm cubeta GN 1/1 20 mm cúpula roll-top.
Inclus: Cadre en bois bac GN 1/1 65 mm perforé bac GN 1/1 20 mm couvercle roll-top

REF	W x D x H cm	
P904165	57 x 37 x 31	1

P904113 Triple buffet display
Buffet triple
Buffet triple



Includes: Wooden frame 3 units 1/3 GN pans 65 mm GN pan 1/1 20 mm roll-top lid.
Incluye: Marco madera 3 cubetas GN 1/3 65 mm cubeta GN 1/1 20 mm cúpula roll-top.
Inclus: Cadre en bois 3 bacs GN 1/3 65 mm bac GN 1/1 20 mm couvercle roll-top.

REF	W x D x H cm	
P904113	57 x 37 x 31	1

P904200 Wooden frame
Marco madera
Cadre en bois



P904120 Standard buffet display
Buffet estandar
Buffet standard



Includes: Wooden frame 2u. 1/1 GN 1/1 20 mm roll-top lid.
Incluye: Marco madera 2 u. cubeta GN 1/1 20 mm cúpula roll-top.
Inclus: Cadre en bois 2 u. bacs GN 1/1 20 mm couvercle roll-top

REF	W x D x H cm	
P904120	57 x 37 x 31	1

P904140 Cheese buffet display
Buffet quesos
Buffet fromage



Includes: Wooden frame wooden cutting board GN pan 1/1 20 mm roll-top lid.
Incluye: Marco madera bandeja corte madera cubeta GN 1/1 20 mm cúpula roll-top.
Inclus: Cadre en bois planque à découper en bois bac GN 1/1 20 mm couvercle roll-top.

REF	W x D x H cm	
P904140	57 x 37 x 31	1

REF	W x D x H cm	
P904200	57 x 37 x 14,5	1

P904400 Isothermal mat
Tapete isotérmica
Tapis isotherme



REF	W x D x H cm	
P904400	47 x 26 x 20	250

P904160 Melamine slate buffet displayer
Buffet pizarra melamina
Mélamine buffet ardoise



Includes: Wooden frame melamine slate board 1/1 GN container 20 mm.
Incluye: Marco madera tabla pizarra melamina cubeta GN 1/1 20 mm.
Inclus: Cadre en bois plaque ardoise en mélamine bac GN 1/1 20 mm

REF	W x D x H cm	
P904160	57 x 37 x 14,5	1

P904146 Wooden bread cutting board
Cortador pan madera
Plaque à découper pain en bois



REF	W x D x H cm	
P904146	52 x 31,5 x 20	1

P904500 Cooling plate
Placa enfriadora
Plaque réfrigérante



● - 12 °C



Adjustable to 1/1 GN pan.
Adaptable a cubeta GN 1/1.
Adaptable à bac GN 1/1.

REF	W x D x H cm	
P904500	47,5 x 27,7 x 3	5

P904145 Bread buffet display
Buffet pan
Buffet pain



Includes: Wooden frame bread cutting board 1/1 GN container 20 mm.
Incluye: Marco madera cortador pan madera cubeta GN 1/1 20 mm.
Inclus: Cadre en bois plaque à découper pain en bois bac GN 1/1 20 mm

REF	W x D x H cm	
P904145	57 x 37 x 14,5	1

P904142 Wooden bread cutting board
Cortador pan madera
Plaque à découper pain en bois



GN 1/1

REF	W x D x H cm	
P904142	53 x 32,5 x 2	1

BUFFETACCESSORIES
BUFFETACCESORIOS
BUFFETACCESSOIRES

BUFFETACCESSORIES
BUFFETACCESORIOS
BUFFETACCESSOIRES

EXCLUSIVE



BUFFET TROLLEY WITH POSSIBLE TRANSFORMATION FROM AN EXPOSITOR TROLLEY TO A PRESENTATION TABLE
CARRO BUFFET CON POSIBILIDAD DE CONVERTIR EL CARRO EXPOSITOR EN MESA DE PRESENTACIÓN
CHARIOT BUFFET AVEC POSSIBILITÉ DE CONVERTIR LE CHARIOT D'EXPOSITION EN UNE TABLE DE PRÉSENTATION



***Two cover are included on the price**
**Dos tapas incluidas en precio*
**Deux tablettes comprises dans le prix*
P90492

Cover for 1/1 GN insert not included on the price
Tapa individual encaje GN 1/1 no incluida en precio
Tablette de bac GN 1/1 non comprise dans le prix
P90493

P90490 Black buffet trolley for 4 1/1 GN inserts
Carro buffet negro 4 GN 1/1
Chariot buffet noir pour 4 bacs GN 1/1



REF	Type / Tipo	
P90490*	4 X GN 1/1	1
P90492	Tapa / Cover / Tablette	1
P90493	Tapa / Cover / Tablette 1/1	1

Outstanding combination of wood and aluminium

Elegante combinación de madera y aluminio
Combinaison élégante en bois et en aluminium



Wood with special waterproof treatment, easy to clean
Madera con tratamiento hidrófugo especial, de fácil limpieza
Bois avec un traitement hydrofuge spécial, facile à nettoyer

Reinforcement bar
Barra refuerzo nivel inferior
Barre de renforcement

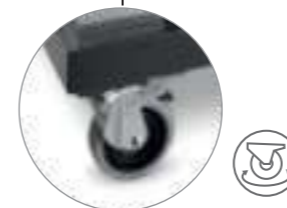

Soundproof and revolving castors
Ø 125 mm, with brakes
Ruedas giratorias e insonoras de Ø 125 mm, con freno
Roulettes insonores et pivotantes de Ø 125 mm, avec freins



Delivered flatpacked between 3 to 5 minutes assembly
Se suministran desmontados entre 3 a 5 minutos de montaje
Livrés démontés entre 3 et 5 minutes de montage



Suitable for gastronorm sizes
Adaptado a medidas gastronorm
Adapté aux mesures gastronorme

TREND **Wooden-aluminium trolley 2 shelves**
Carro madera-aluminio 2 estanterías
Chariot en bois-aluminium 2 plateaux



REF	Colour	
P80220	Negro / Black / Noir	1

P80219 **Wooden gueridon trolley**
Gueridón o carro auxiliar madera
Chariot guéridon en bois

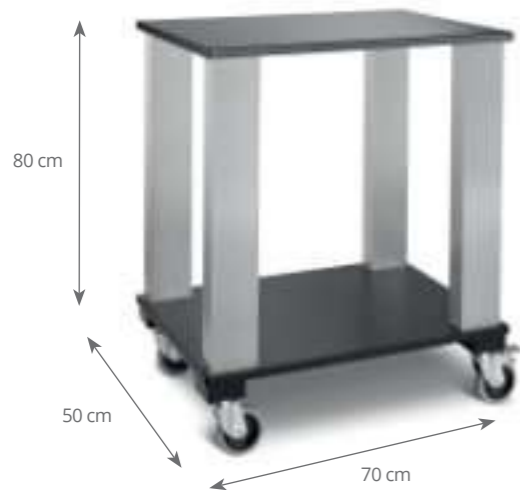

REF	Colour	
P80219	Negro / Black / Noir	1

P80216 **Oak melamine gueridon trolley**
Carro guerdón melamina roble
Chariot guéridon mélamine roure



REF		
P80216		1

P90813 **Cutlery dispenser trolley**
Carro porta-cubiertos
Chariot porte couverts



Trays, dishes, GN containers and cutlery dispenser not included
No incluye porta-cubiertos, cubetas GN, platos ni bandejas
Ramasse-couverts, bacs GN, assiettes, et plateaux pas compris

REF		
P908132		1
P90813		1

P90814 **Cutlery bin**
Porta-cubiertos
Ramasse-couverts

EXCLUSIVE

4 x 1/3 GN
H max. 6,5 cm



GN containers not included
No incluye cubetas GN
Bacs GN non inclus

REF	W x D x H mm	
P908142	710 x 335 x 155	1
P90814	710 x 335 x 155	1

14.8 Chafers & dispensers

Chafings y dispensadores
Chafers et distributeurs



An elegant yet versatile chafer with a low profile design for the best food presentation.

Glass top version allows viewing of food without opening chafer - maintaining food quality.

Removable cover with baffle, "stay put" hinge design holds cover in closed, 45° or 90° position.

Reinforced bracket with rubber table feet for longer life and to keep chafer in place.

Dripless cover and pans keep condensation off of food and tabletop.

Available with mirror-finished stainless steel or porcelain food pans.

Un elegante y versátil chafer con un diseño de perfil bajo para una mejor presentación.

Modelo con parte superior de vidrio que permite ver la comida sin abrir el chafer - manteniendo la calidad del alimento.

Tapa removible con bisagra de cierre lento. Tres ángulos de apertura, cerrada, 45° ó 90°.

Soporte reforzado con piés antideslizantes que permite una mayor estabilidad.

La tapa y cubeta con sistema anti-goteo mantienen la condensación fuera del alimento.

Se presenta con cubetas de acero inoxidable brillante o de porcelana.

Un chafer élégant à la fois polyvalent et discret pour la meilleure présentation des plats.

Le modèle muni d'un couvercle en verre permet de voir le contenu sans ouvrir le chafer - tout en préservant la qualité des aliments.

Couvercle amovible équipé d'un déflecteur et d'une charnière bloquante qui permet de maintenir le couvercle fermé, à 45° ou à 90°.

Support renforcé avec des pieds de table en caoutchouc afin d'offrir une durée de vie plus longue et un meilleur maintien des chafers.

Le couvercle antigouttes et les bacs empêchent la condensation des aliments et de la table.

Disponibles avec bac à aliments en inox ultra-brillant ou en porcelaine.

4644010 Rectangular chafing dish with crystal lid
Chafing dish rectangular con tapa de cristal
Chauffe-plat rectangulaire avec couvercle en verre

SS Stainless steel
Cr Crystal
induction

NEW!



REF	W x D x H cm	
4644010	58,4 x 46,5 x 19,8	1

4644020 Square chafing dish with crystal lid
Chafing dish cuadrado con tapa de cristal
Chauffe-plat carré avec couvercle en verre

SS Stainless steel
Cr Crystal
induction

NEW!



REF	W x D x H cm	
4644020	46,4 x 46,4 x 17	1

Chafers & dispensers 14.8

Chafings y dispensadores
Chafers et distributeurs

46132 Square chafing dish
Chafing dish cuadrado
Chauffe-plat carré

SS Stainless steel
induction

NEW!



REF	W x D x H cm	
46132	39,2 x 41,3 x 20,3	1

46134 Glass top S/S chafer with S/S trim
Chafing dish cuadrado con tapa cristal
Chafer inox à couvercle en verre

SS Stainless steel
Cr Crystal
induction



REF	W x D x H cm	L	
46134	392 x 176 x 412	5,8	1

46124 Glass top S/S chafer with S/S trim
Chafing dish redondo con tapa cristal
Chafer inox à couvercle en verre

SS Stainless steel
Cr Crystal
induction

NEW!



Details in Golden colour.
Detalles en color dorado.
Détails en couleur dorée.

REF	Ø cm	H cm	L	
46124	39,4	8	5,8	1

46125 Glass top S/S chafer with S/S trim
Chafing dish redondo con tapa cristal
Chafer inox à couvercle en verre

SS Stainless steel
Cr Crystal
induction



REF	Ø cm	H cm	L	
46125	39,4	8	5,8	1

46131 Food pan
Fuente interior redonda
Bac à aliments

SS Stainless steel



REF	cm	L	
46131	39,4 x 7	5,6	1
46861	39,4 x 7	3,8	1 NEW

46137 Food pan
Fuente interior cuadrada
Bac à aliments

SS Stainless steel



REF	W x D x H cm	L	
46137	39,2 x 7,1 x 39,2	6,3	1

14.8 Chafers & dispensers

Chafings y dispensadores
Chafers et distributeurs



P3875 Rectangular chafing dish roll top lid
Chafing dish rectangular con tapa roll top
Chafing dish rectangulaire avec couvercle roll top



Stand, water pan, insert, lid and St/Steel handles.
With 2 burners.

Soporte, recipiente, cubeta, tapa y asas de chapa en acero inox.
Con 2 quemadores.

Support, récipient, bac, couvercle et poignées en acier inox.
Avec 2 brûleurs.

REF	W x D x H cm	L	
P387500	74 x 45 x 41	9,0	1

P8975 Round chafing dish roll top lid
Chafing dish redondo tapa roll top
Chafing dish rond avec couvercle roll top

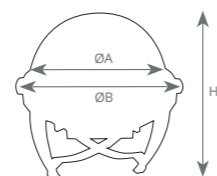

Max. opening: 180°.
Apertura máxima: 180°.
Ouverture maximale: 180°.

REF	ØA cm	ØB cm	H cm	
P897500	35	51,5	48,5	1

Chafers & dispensers 14.8

Chafings y dispensadores
Chafers et distributeurs



46080 Oblong roll top chafer
Chafer apaisado con tapa roll top
Couvercle roll top rectangulaire chauffe-plat



NEW!

Stand, water pan, insert, lid and St/Steel handles.
With 2 burners.

Soporte, recipiente, cubeta, tapa y asas de chapa en acero inox.
Con 2 quemadores.

Support, récipient, bac, couvercle et poignées en acier inox.
Avec 2 brûleurs.

REF	W x D x H cm	
46080	65,6 x 44,5 x 46,7	1

P387 Chafing dish with roll top lid
Chafing dish con tapa roll top
Chafing dish avec couvercle "roll top"



Stand, water pan, insert, lid and St/Steel handles.
With 2 burners.

Soporte, recipiente, cubeta, tapa y asas de chapa en acero inox.
Con 2 quemadores.

Support, récipient, bac, couvercle et poignées en acier inox.
Avec 2 brûleurs.

REF	W x D x H cm	L	
P387065	65 x 38 x 39	9,5	1

P379 Chafing dish with lid
Chafing dish con tapa
Chafing dish avec couvercle



Stand, water pan, insert, lid and St/Steel handles.
With 2 burners.

Soporte, recipiente, cubeta, tapa y asas de chapa en acero inox.
Con 2 quemadores.

Support, récipient, bac, couvercle et poignées en acier inox.
Avec 2 brûleurs.

REF	W x D x H cm	L	
P379065	65 x 35 x 34	9,5	1

46095 Gravy/sauce chafer
Chafer de salsas
Réchauffeur de sauce



NEW!

REF	W x D x H cm	
46095	31,8 x 29,2 x 37,8	1

46070 Round roll top chafer
Chafer redondo con tapa roll top
Couvercle roll top chauffe-plat



NEW!

REF	W x D x H cm	
46070	49,2 x 48 x 46,5	1

P3795 Economical chafing dish with lid
Chafing dish económico con tapa
Chafing dish économique avec couvercle



Stand, water pan, insert, lid and St/Steel handles.
With 2 burners.

Soporte, recipiente, cubeta, tapa y asas de chapa en acero inox.
Con 2 quemadores.

Support, récipient, bac, couvercle et poignées en acier inox.
Avec 2 brûleurs.

REF	W x D x H cm	L	
P379500	65 x 35 x 32	9	1

14.8 Chafers & dispensers

Chafings y dispensadores
Chafers et distributeurs

P950000 Electric heating unit for chafing dish
Elemento eléctrico para chafing dish
Corps de chauffe pour chafing dish

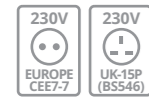

For / Para / Pour:
P387500, P897500, P387065, P379065, P379500

REF	W	
P950000	240	1

P962 Hot tray warmer
Calentador de platos o bandejas
Réchaud



P3722 Burner holder for chafing dish
Contenedor para combustible de chafing dish
Porte-brûleur pour chafing dish



Adaptable. REF:
P379, P387, P898, P8991

REF		
P372200		24

P3871 Chafing dish fuel
P3872 Fuel para chafing dish
Fuel pour chafing dish



REF	cm	Length / Duración Durée	
P387100	65 x 55	3 h	75
P387200	83 x 60	6 h	60

46110 Universal electric chafer heater
Elemento eléctrico universal para chafing dish
Résistance électrique pour chafers

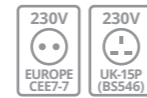

Sized to fit standard fuel opening.
Dimensiones compatibles con el orificio para combustible estándar.
Dimensions compatibles avec l'orifice pour combustible standard.

REF	For / Para	V	W	A	Ench. Plug	
46110	EU	230	120/230	1.0	EU	1
46115	UK	230	120/230	1.0	UK	1

REF	Burners / Quemadores Brûleurs	W x D x H cm	
P962002	2	370 x 175 x 70	10
P962003	3	430 x 175 x 70	10

St/Steel with aluminium cover plate.
Inox con placa base de aluminio.
Inox avec plaque couvercle en aluminium.

2 or 3 burners.
2 ó 3 quemadores.
2 ou 3 brûleurs.

P685 Chafing dish fuel barrel
Fuel para chafing dish
Bidón fuel chafing dish



No soot. No smell
Sin hollín. Sin olor
Pas de suie. Inodore

REF	L	KG	
P685004	5	5	3

Thanks to its special formula no storage or transport restriction are involved. Resealable. Non spill - Non drip. Non flammable. Non combustible. Non toxic fuel. Easy open & close. Container does not become hot to touch. Does not evaporate if left uncapped.

Gracias a su fórmula especial no hay ninguna restricción especial por almacenaje o transporte. No gotea ni se derrama. No se evapora si se deja abierto. Puede guardarse si no se consume todo. No inflamable. No tóxico. Fácil de abrir y cerrar. La lata no se calienta. Fácil de encender una vez apagada.

Grâce à sa formule spéciale il n'y a pas de restriction pour le stockage et le transport. Hermétique. Non inflammable. Non combustible. Non toxique. Facile à ouvrir et fermer. On peut le garder si on ne le consomme pas tout. Facile à allumer une fois éteint.

Chafers & dispensers 14.8

Chafings y dispensadores
Chafers et distributeurs



P903 Cooling plate
Placa enfriadora
Plaque réfrigérante



REF	Type / Tipo	cm	
P903001	1/1	53 x 32,5	4
P903002	1/2	32,5 x 26,5	6

For an easy and hygienic presentation of cold food. Simple place in the freezer. Minimum 4 hour under -4°C. Tolerance under 23°C: 5-6h.

Para una presentación fácil e higiénica de alimentos fríos en los buffets. En el congelador: Mínimo 4h por debajo de los -4 °C. Aguanta 5-6h con temperaturas por debajo de los 23 °C.

Pour une présentation hygienique et facile des aliments froids sur les buffets. Au congélateur. Minimum 4h à des températures inférieures à -4 °C. Résistance à des températures inférieures à 23 °C: 5-6h.

78710 Bain maries
Baño maría
Bain-marie



REF	Ø cm	H cm	L	
78710	10,5	14,5	1,20	6
78720	12,5	17,0	1,90	6
78725	15,5	10,0	1,90	6
78730	15,5	18,5	3,30	6
78740	16,5	19,5	4,00	6
78760	18,5	22,0	5,70	6

14.8 Chafers & dispensers

Chafings y dispensadores
Chafers et distributeurs



4609 Coffee urn
Urna de café
Boîte à café

NEW!



REF	W x D x H cm	
46093	31,6 x 34,3 x 50,3	1
46094	39,4 x 41,8 x 54,5	1

46285 Cold beverage server
Dispensador de bebidas frías
Distributeur boisson froide

NEW!



REF	W x D x H cm	
46285	20,3 x 28 x 53,3	1

4635810 Somerville cold beverage server
Dispensador de bebidas frías-Somerville
Distributeur de boisson froide Somerville

NEW!



REF	W x D x H cm	
4635810	24,6 x 29 x 64	1

4635110 Somerville milk dispenser
Dispensador de leche-Somerville
Distributeur de lait Somerville

NEW!



REF	W x D x H cm	
4635110	20,3 x 32,7 x 41,4	1

Chafers & dispensers 14.8

Chafings y dispensadores
Chafers et distributeurs

P8992 Juice dispenser St/Steel
Dispensador de zumos - acero inox
Distributeur à jus - acier inox



REF	L	
P899200	8	1

P8993 St/Steel milk dispenser
Dispensador de leche - acero inox
Distributeur à lait - acier inox



REF	L	
P899300	8	1

4635210 Double Cereal Dispenser
Dispensador de cereales doble
Distributeur à céréales double



REF	W x D x H cm	L (x2)	
4635210	31 x 22 x 60	3,8	1

T3660 D-Lux cereal dispenser
Dispensador de cereales D-Lux
Distributeur à céréales D-Lux



REF	W x D x H cm	L	
T3660	25,4 x 35,6 x 68,6	8	1

BUFFET/ACCESSOIRES
BUFFET/ACCESÓRIOS
BUFFET/ACCESSOIRES

BUFFET/ACCESSOIRES
BUFFET/ACCESÓRIOS
BUFFET/ACCESSOIRES

14.9 Bowls & serving trays

Bols & bandejas de servicio
Bols & plateaux

18/10
Stainless steel

Double wall insulated serving bowls that allows keeping the food temperature, whether cold or hot.

Construcción aislante de pared doble que permite conservar la temperatura de los alimentos, ya sean fríos o calientes.

Construction d'isolation à double paroi qui permet de maintenir la température de la nourriture, froide ou chaude.



Will not TRANSPIRE. Requires no preheating or chilling
No transpiran. No es necesario precalentar o enfriar
Pas de condensation sur les parois. N'exige aucun préchauffage ou refroidissement

Insulating walls that keep food at service temperature
Paredes aislantes que mantienen los alimentos a la temperatura de servicio
Construction isolant qui garde les aliments à la température de service



COLD RETENTION: Double wall insulated bowls TEST PROTOCOL, 2004
RETENCIÓN DEL FRÍO: Bols aislantes de doble pared PROTOCOLO DE PRUEBA, 2004
RÉTENTION DU FROID: Construction d'isolation à double paroi PROTOCOLE D'ESSAI, 2004

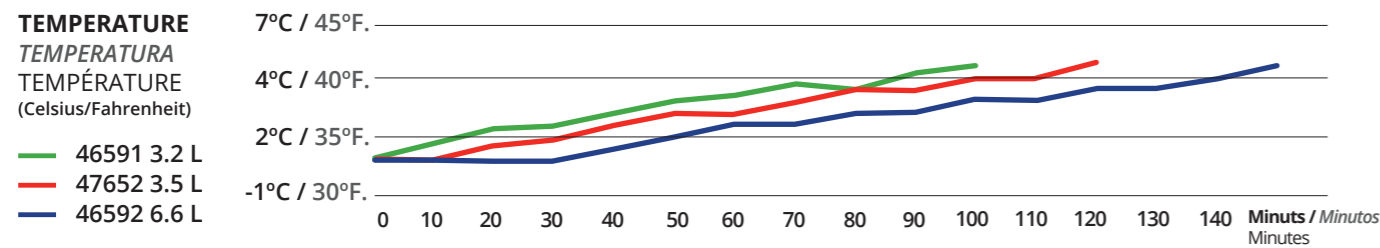

- | | | |
|--|--|--|
| <p>1. Potato salad was placed in different bowls. Filling ¾ of the capacity of the bowl.</p> <p>2. Initial temperature of the food 0.6°C; ambient temperature 20.6°C.</p> <p>3. The temperature in the centre of the salad was recorded every 10 minutes.</p> <p>4. The test concluded when the food reached a temperature of 5°C.</p> | <p>1. Se colocó ensalada de patatas en diversos bols, llenando ¾ de la capacidad del bol.</p> <p>2. Temperatura inicial de la comida 0,6°C; temperatura ambiente 20,6°C.</p> <p>3. Cada 10 minutos se registró la temperatura en el centro de la ensalada.</p> <p>4. La prueba concluyó cuando la comida alcanzó una temperatura de 5°C.</p> | <p>1. La salade de pommes de terre a été placée dans différents bols. Remplissage ¾ de la capacité du bol.</p> <p>2. La température initiale de l'aliment 0,6°C; température ambiante 20,6°C.</p> <p>3. La température au centre de la salade a été enregistrée toutes les 10 minutes.</p> <p>4. Le test s'est terminé lorsque la nourriture a atteint une température de 5°C.</p> |
|--|--|--|

Bowls & serving trays 14.9

Bols & bandejas de servicio
Bols & plateaux

18/10
Stainless steel

46590 Round colored double wall bowls
Bol colores redondo doble pared
Bols ronds de service à double paroi isothermes en couleurs



REF	Ø cm	H cm	L	Box
46590 + COLOR	18,4	10,3	1,6	6
46591 + COLOR	24,1	12,9	3,2	6
46592 + COLOR	30,0	16,5	6,6	3

46584 Angled beehive bowls
Bol inclinado doble pared
Bols nid d'abeilles à paroi inclinée



REF	Ø cm	H cm	L	Box
46584	18,8	13,9	0,95	6
46585	24,0	17,3	1,7	6
46586	30,0	20,9	3,5	2
46582	35,0	23,9	4,7	2

46587 Beehive style double-wall serving bowls
Bol estridado redondo doble pared
Bol à bande rond double paroi

NSF
Mirror finished
Acero inoxidable brillante
Polissage brillant



REF	Ø cm	H cm	L	Box
46587	14,4	7,6	0,7	6
46590	18,4	10,3	1,6	6
46591	24,1	12,9	3,2	6
46592	30,0	16,5	6,6	3
46569	35,0	17,5	9,6	2

47632 Square colored double wall bowls
Bol colores cuadrado doble pared
Bols carrés de service à double paroi isothermes en couleurs



REF	cm	H cm	L	Box
47632 + COLOR	18,4 x 18,4	8,7	1,7	12
47634 + COLOR	21,6 x 21,6	10,8	3,0	6
47635 + COLOR	25,8 x 25,8	13,0	4,9	4

47619 Double-wall square beehive serving bowls
Bol estriado cuadrado doble pared
Bol lis carré double paroi



REF	W x D x H cm	L	Box
47619	13,9 x 13,9 x 7	0,7	6
47632	18,5 x 18,5 x 8,9	1,7	12
47634	21,8 x 21,8 x 10,8	3,0	6
47635	24,4 x 24,4 x 13,1	4,9	4
47637	29,9 x 29,9 x 15	7,8	3

46665 Beehive style double-wall serving bowls
Bol redondo doble pared con aro brillante
Bol bande brillant rond double paroi

NSF
Body mat finished.
Rim mirror finished.
Cuerpo pulido satinado.
Borde superior pulido brillante.
Finition corps satinée.
Finition bande brillante.



REF	Ø cm	H cm	L	Box
46665	14,4	7,6	0,7	6
46666	18,4	10,3	1,6	6
46667	24,1	12,9	3,2	6

14.9 Bowls & serving trays

Bols & bandejas de servicio
Bols & plateaux

18/10
Stainless
steel

Satin-finished rim and mirror-finished interior creates a visual contrast that accentuates the food product

Borde con acabado satinado e interior brillante, creando una elegante contraste visual

Le rebord satiné et l'intérieur ultra-brillant crée un contraste visuel qui met en valeur les plats

82093 Rectangular Stainless Steel serving trays
Bandeja servicio rectangular acero inoxidable
Plateau service rectangulaire

46221 Curved tray
Bandeja curva
Plateau incurvé



REF	cm	
82093	30,5 x 22,9	3
82094	45,7 x 25,4	3
82095	53,3 x 30,5	3

REF	cm	
46221	19,1 x 19,1	1

P3174 Economical oval serving dish with rolled edge
Fuente oval borde vuelto económica
Plat ovale à bords ronds économique

P317 Oval serving dish with rolled edge
Fuente oval borde vuelto
Plat ovale à bords ronds

Mirror finished
Pulido brillante
Polissage brillant

Satin finished
Pulido satinado
Polissage satiné



REF	cm	
P317425	25 x 17,5	60
P317430	30 x 21,0	60
P317435	35 x 24,0	60
P317440	40 x 26,5	40
P317445	45 x 29,5	30
P317450	50 x 34,0	24

REF	cm	
P317025	25 x 17,2	1
P317030	30 x 20,2	1
P317035	35 x 23,3	1
P317040	40 x 26,7	1
P317045	45 x 29,2	1
P317050	50 x 31,2	1

Bowls & serving trays 14.9

Bols & bandejas de servicio
Bols & plateaux

P907 St/Steel soup tureen with stand
Sopera inox con base
Soupière inox avec pied

P927 Acrylic round salad bowl
Ensaladera acrílica redonda
Saladier rond acrylique

SS
Stainless
steel

Ac
Acrylic

Mirror finished
Pulido brillante
Polissage brillant



REF	Ø cm	L	
P907024	24	2,50	6
P907026	26	3,50	6

REF	Ø cm	H cm	
P927000	25,8 x 15,8	15,8	6

P928 Acrylic Squared salad bowl
Ensaladera acrílica cuadrada
Saladier carré acrylique

Ac
Acrylic

REF	W x D x H cm	
P928000	28,5 x 28,5 x 12,4	12
P928001	14,7 x 14,7 x 7	48



See products on / Ver productos en / Voir produits en page

P. 388

Bandejas de servicio y buffet
Bandejas de servicio y buffet
Plateaux de service et de buffet





Serving tools 14.10

Utensilios de servicio
Ustensiles de service buffet

CLASSIC LINE



P361 One piece ladle
Cacillo monobloc
Louche monobloc



REF	Ø cm	L cm	L	📦
P361000	9	30	0,10	120

P362 One piece skimmer
Espumadera monobloc
Écumoire monobloc



REF	Ø cm	L cm	L	📦
P362000	11	33,5	10,40	120

P363 One piece turner
Espátula monobloc
Spatule monobloc



REF	L cm	📦
P363000	32	120

P364 One piece serving spoon
Cuchara de servicio monobloc
Cuillère de service monobloc



REF	L cm	📦
P364000	31	120

P365 One piece fork
Tenedor monobloc
Fourchette monobloc



REF	L cm	📦
P365000	32	120

P366 One piece sauce ladle
Cacillo salsas monobloc
Cuillère à sauces monobloc



REF	Ø cm	L cm	L	📦
P366000	7	28	0,10	120

P367 One piece salad spoon
Cuchara ensalada monobloc
Cuillère à salade monobloc



REF	L cm	📦
P367000	30	72

P368 Carving knife
Cuchillo cocina
Couteau à pâtisserie



REF	L cm	📦
P368000	28,5	240

P369 Cake server
Pala pasteles
Pelle à gâteau



REF	L cm	📦
P369000	22	120

14.10 Serving tools

Utensilios de servicio
Ustensiles de service buffet



ERGO LINE



Mirror polishing.
Pulido brillante.
Polissage brillant.

P3611 One piece ladle
Cacillo monobloc
Louche monobloc



REF	Ø cm	L cm	L	
P361100	9,5	32	0,15	48

P3621 One piece skimmer
Espumadera monobloc
Écumoire monobloc



REF	Ø cm	L cm	L	
P362100	11	35	7,15	48

P3631 One piece turner
Espátula monobloc
Spatule monobloc



REF	L cm	
P363100	37	48

P3641 One piece serving spoon
Cuchara de servicio monobloc
Cuillère de service monobloc



REF	L cm	
P364100	34,5	48

P3651 One piece fork
Tenedor monobloc
Fourchette monobloc



REF	L cm	
P365100	37	48

P3671 Spaghetti server
Cuchara para spaghetti
Cuillère à spaghetti



REF	L cm	
P367100	35	48

P3691 Cake server
Pala pasteles
Pelle à gâteau



REF	L cm	
P369100	31	48

Serving tools 14.10

Utensilios de servicio
Ustensiles de service buffet



COMET LINE



Mat satiny finished.
Pulido satinado mate.
Poli satiné mat.

P341 One piece ladle. 18% cr. St/Steel
Cacillo monobloc. Acero inox 18% cr.
Louche monobloc. inox 18% cr.



REF	Ø cm	L cm	L	
P341000	8,5	28	0,10	120

P342 One piece skimmer. 18% cr. St/Steel
Espumadera monobloc. inox 18% cr.
Écumoire monobloc. inox 18% cr.



REF	Ø cm	L cm	
P342000	11	33	120

P343 One piece turner. 18% cr. St/Steel
Espátula monobloc. inox 18% cr.
Spatule monobloc. inox 18% cr.



REF	L cm	
P343000	33	120

P344 One piece fork. 18% cr. St/Steel
Tenedor monobloc. inox 18% cr.
Fourchette monobloc. inox 18% cr.



REF	L cm	
P344000	30	120

P345 One piece spoon. 18% cr. St/Steel
Cuchara monobloc. inox 18% cr.
Cuillère monobloc. inox 18% cr.



REF	L cm	
P345000	34	120

48144 Steak knife black plastic handle
Cuchillo chuletero, mango plástico negro
Couteau Steak manche noir plastique



REF	Blade / Hoja / Lame L cm	Total L cm	
48144	12,4	25,1	12

Price / Precio / Prix: Pack 12 u

48148 Steak knife riveted wooden handle
Cuchillo chuletero, mango plástico mader
Couteau Steak manche bois plastique



REF	Blade / Hoja / Lame L cm	Total L cm	
48148	12,7	25,1	12

Price / Precio / Prix: Pack 12 u

14.10 Serving tools

Utensilios de servicio
Ustensiles de service buffet

SS
Stainless
steel

NEW!

46905 Ladle with one spout
Cacillo con un pico lateral
Louche avec bec latéral



REF	L cm	
46905	28,71	12

46907 Ladle with one spout
Cacillo con un pico lateral
Louche avec bec latéral



REF	L cm	ml	
46907	32	59,15	12

46909 Ladle
Cacillo
Louche



REF	L cm	
46909	32	12

46936 Pastry server
Servidor de pasteles
Pelle de service



REF	L cm	
46936	28	12

46952 Serving spoon
Cuchara de servicio
Cuillère de service



REF	L cm	
46952	29,5	12

46960 Slotted serving spoon
Cuchara perforada para servir
Cuillère à fente de service



REF	L cm	
46960	30,5	12

6440 Spoon
Cuchara
Cullière



REF	L cm	
64403	33,60	12
64404	33,60	12
64406	39,37	12
64407	39,37	12

VOLLRATH

444

pujadas

Serving tools 14.10

Utensilios de servicio
Ustensiles de service buffet

SS
Stainless
steel

Ny
Nylon



P33621 Ladle
Cacillo
Louche

REF	L cm	Lts	
P33621	35	0,08	1

P33622 Serving spoon
Cuchara de servicio
Cuillère de service



REF	L cm	
P33622	35	1

P33623 Slotted spoon
Cuchara perforada
Cuillère à fente



REF	L cm	
P33623	35	1

P33624 Turner
Espátula
Patule



REF	L cm	
P33624	35	1

P33625 Spaghetti server
Cuchara para spaghetti
Cuillère à spaghetti



REF	L cm	
P33625	35	1

VOLLRATH

445

pujadas



BUFFETACCESSOIRES
BUFFETACCESSOIOS
BUFFETACCESSOIRES

BUFFETACCESSOIRES
BUFFETACCESSOIOS
BUFFETACCESSOIRES

14.10 Serving tools

Utensilios de servicio
Ustensiles de service buffet



dishwasher

P33801 Serving spoon
Cuchara de servicio
Cuillère de service



REF	L cm	
P33801	30,5	1

P33802 Slotted spoon
Cuchara perforada
Cuillère à fente



REF	L cm	
P33802	30,5	1

P33803 Turner
Espátula
Spatule



REF	L cm	
P33803	30,5	1

P33804 Spaghetti server
Cuchara para spaghetti
Cuillère à spaghetti



REF	L cm	
P33804	30,5	1

P33805 One piece fork
Tenedor de mesa
Fourchette



REF	L cm	
P33805	30,5	1

P33806 Serving tong
Pinza de servicio
Pince de service



REF	L cm	
P33806	28	1

P33807 Bread spoon
Pinza de pan
Pince à pain



REF	L cm	
P33807	25,5	1

P33808 Salad hands
Servidor de ensalada
Serveur salade



Pack: 2 u.

REF	L cm	
P33808	17,5	1

P33809 Knife
Cuchillo
Couteau



REF	L cm	
P33809	17,5	1

Serving tools 14.10

Utensilios de servicio
Ustensiles de service buffet



P358 Coloured BPA Free utility tong
Pinza buffet BPA Free color
Pince buffet SANS BPA en couleurs



REF 358 + L + COLOR



REF	L cm	Clear Transp.	White Blanco Blanc	Red Rojo Rouge	Black Negro Noir	
P358	23	0	1	2	7	1

46938 Buffet tong
Pinza buffet
Pince à buffet



REF	L cm	
46938	30,5	6

46926 Serving tong
Pinza servicio
Pince de service



REF	L cm	
46926	21	12

4698 Spaghetti tong
Pinza espaguete
Pince à spaghetti

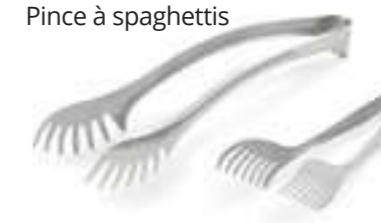

REF	L cm	
46988	23,0	12
46989	29,2	12

14.10 Serving tools

Utensilios de servicio
Ustensiles de service buffet



P359 Serving tong
Pinza de servicio
Pince de service



REF **P359000** L cm 24 1

P353 Salad tong
Pinza ensalada
Pince à salade



REF **P353000** L cm 26,5 120

46928 Bread tong
Pinza pan
Pince à pain



REF **46928** L cm 23,5 12

P606 Bread tong
Pinza pan
Pince à pain



REF **P606000** L cm 25 72

P605 Pasta tong
Pinza pasta
Pince à pâtes



REF **P605000** L cm 24 120

P351 Spaghetti tong
Pinza spaghetti
Pince à spaghetti



REF **P351000** L cm 19 120

P352 Cake tong
Pinza repostería
Pince à gâteau



REF **P352000** L cm 18 120

P617 Tong with ring
Pinza anillas
Tong with ring



REF **P617017** L cm 17 100

Serving tools 14.10

Utensilios de servicio
Ustensiles de service buffet



P618 Burger tong
Pinza hamburguesa
Pince à "burger"



REF **P618000** L cm 24 1

46929 Pastry tong
Pinza pastelería
Pince à pâtisserie



REF **46929** L cm 20 24



P615 Nut cracker
Cascanueces
Casse-noix



REF **P615000** L cm 16,5 120

P902 Butcher's tong
Pinza charcutería
Pince à charcuterie



REF **P902000** L cm 10,5 x 5 1

P389 Aluminium lobster cracker
Pinza para mariscos en aluminio
Casse-pattes en aluminium



REF **P389000** L cm 14 144

14.11 Signs

Señalización
Signalization

P19117 Barrier with retractable belt

Poste con cinta retráctil
Poteau dérouleur à sangle

SS
Stainless steel

Painted negro
Black-painted
Peint noir

BEST SELLER



REF	H cm	Kg	
P19117	90	7	2

P19114 Barrier with retractable belt

Poste con cinta retráctil
Poteau dérouleur à sangle

SS
Stainless steel

Mirror Polished.
Pulido brillante.
Polissage brillant.

Detachable head.
Cabezal removible.
Tête amovible.



REF	Colour / Color / Couleur	H cm	L cm	Kg	
P19114N	●	94	200	9	1
P19114A	●	94	200	9	1
P19114R	●	94	200	9	1

P19118 Information sign

Panel información
Panneau information

SS
Stainless steel

For barrier
Para poste
Pour poteau
P19.117



REF	cm	
P19118	22 x 46	10

P19115 Spare head

Recambio cabezal
Rechange de sangle

SS
Stainless steel

For barrier
Para poste
Pour poteau
P19.114



REF	Colour / Color / Couleur	L cm	
P19115N	●	200	12
P19115A	●	200	12
P19115R	●	200	12

P19116 Information sign

Panel información
Panneau information

SS
Stainless steel

For barrier
Para poste
Pour poteau
P19.114



REF	cm	
P19116	21,8 x 32	10

P19100 St/Steel barrier

Poste separación acero inoxidable
Poteau acier inoxydable

SS
Stainless steel

P19100
Mirror Polished.
Pulido brillante.
Polissage brillant.

P19101
Golden coated.
Baño dorado.
Doré.

Belt not included
Cordón no incluido
Cordon non inclus

Ref. P19100

Ref. P19101



REF	H cm	Kg	
P19100	95	10,5	2
P19101	100	10,5	2

P19105 Belt with chromium-plated ends

Cordón con ganchos cromados
Cordon à crochets chromés

Te
Textile



REF	Colour / Color / Couleur	L cm	
P19105	●	150	18
P19107	●	150	18
P19103	●	150	18

P19106 Belt with golden ends

Cordón con ganchos dorados
Cordon à crochets dorés

Te
Textile



REF	Colour / Color / Couleur	L cm	
P19106	●	150	18
P19104	●	150	18

Signs 14.11

Señalización
Signalization

Produced from special plastic completely anti-scratch material. Solid wood frame double-lacquered. Rain and sunproof. Writing-surfaces specially designed for using water based chalkmarkers.

Fabricadas con un material plástico especial que no se raya. Marcos de madera resistentes al agua y al sol. Pizarras especialmente diseñadas para el uso de tizas o rotuladores con base de agua. Fabriqués avec un matériel plastique spécial anti-rayures. Cadres en bois massif. Résistants à la pluie et au soleil. Tableaux spécialement conçus pour l'utilisation des craies ou marqueurs avec base à eau.

P21000/ P21001 Caballete - Duo

Wo
Wood

PI
Plastic



REF	W cm	H cm	
P21000	75	135	1
P21001	55	85	1

P21003 Caballete - Uno

Wo
Wood

PI
Plastic



REF	W cm	H cm	
P21003	55	85	1

P2100 Universal

Wo
Wood

PI
Plastic



REF	W cm	H cm	
P21005	50	60	5

P2101 Lucky

Wo
Wood

PI
Plastic

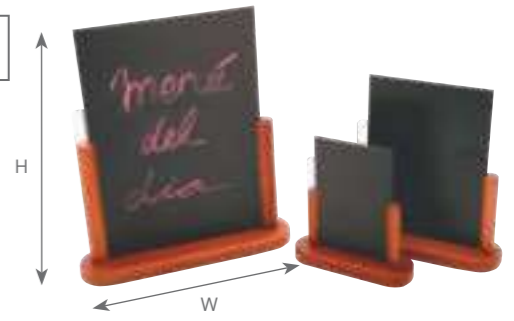

REF	W cm	H cm	
P21015	10	15	36
P21016	15	21	24
P21017	21	30	10

P2102 Basic

PI
Plastic



REF	W cm	H cm	
P21027	10	15	200
P21028	15	23	100

P21020-26 Chalkmarker

Marcador tiza
Marqueur

PI
Plastic

Widths 2-6 mm
Grueso 2-6 mm
Épaisseur 2-6 mm



REF	Colour / Color / Couleur	
P21020	White / Blanco / Blanc	500

15 Tableservice

Servicio de mesa
Arts de table

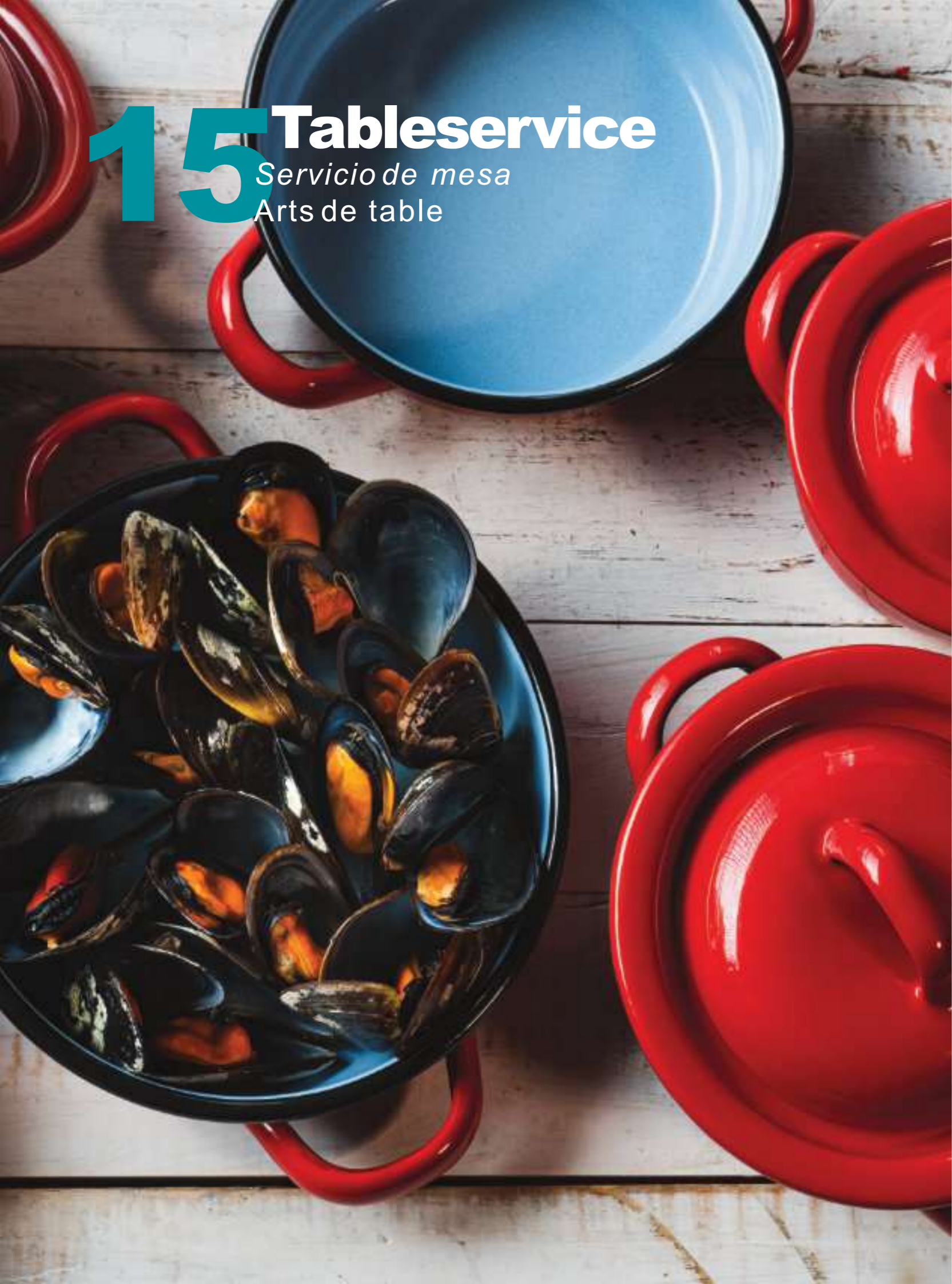

15.1 MINIATURES 454

MINIATURAS / MINIATURES

Stainlesssteel / Acero inoxidable / Acier inoxidable	454
Enamelledsteel / Acero esmaltado / Acier émaillé	458
Cast aluminium / Aluminio de fundición / Fonte d'aluminium	459
Cast iron / Hierro fundido / Fonte émaillée	460

15.2 TABLEPRESENTATION 462

PRESENTACIÓN DE MESA / PRÉSENTATION TABLE

Wood / Madera / Bois	462
Taco and sandwich tray / Tacos y bocadillos presentación Présentation de Tacos et sandwichs	463
Tin plates display / Llaunas presentación / Plateaux inox présentation	464
Slates / Pizarras / Ardoises	466
Natural bamboo / Bambú natural / Bambou naturel	468
Baskets and bread baskets / Paneras y cestas / Paniers et corbeilles	470
Placemats / Mantel individuales / Sets de table	478

15.3 TABLESERVICE 479

SERVICIO DE MESA / SERVICE DE TABLE

Flared sauce cups / Salseras / Saucières	479
Table accessories / Complementos de mesa / Accessoires de table	480
Menu holders / Portamenús / Porte-menus	484
Food & table service / Servicio de mesa / Arts de table	485

15.1 Stainless steel miniatures

Miniaturas acero inoxidable
Miniatures acier inoxydable



P24714 Mini round frying pan

Mini sartén redonda
Mini poêle ronde

NEW!



REF	Ø cm	H cm	📦
P24714	12,0	3,5	6
P24715	15,5	4,5	6

P24716 Mini round saucepan

Mini cazo redondo
Mini casserole ronde

NEW!



REF	Ø cm	H cm	📦
P24716	10,5	5	6
P24717	12,0	6	6

P24718 Mini square frying pan

Mini sartén cuadrada
Mini poêle carrée

NEW!



REF	W x D x H cm	📦
P24718	12 x 12 x 3,5	6
P24719	14 x 14 x 3,5	6

Stainless steel miniatures 15.1

Miniaturas acero inoxidable
Miniatures acier inoxydable



P24706 Mini saucepan

Mini cazo
Mini casserole

NEW!



REF	Ø cm	H cm	📦
P24706	7	4,5	12
P24707	9	5,0	6

P24711 Mini saucepan. Copper color

Mini cazo. Color cobre
Mini casserole. Couleur cuivre

NEW!



REF	Ø cm	H cm	📦
P24711	7	4,5	12
P24712	9	5,0	6

P24708 Mini wok

Mini wok
Mini wok

NEW!



REF	Ø cm	H cm	📦
P24708	10	3	6

P24713 Mini wok. Copper color

Mini wok. Color cobre
Mini wok. Couleur cuivre

NEW!



REF	Ø cm	H cm	📦
P24713	10	3	6

P24704 Mini frying pan

Mini sartén
Mini poêle

NEW!



REF	Ø cm	H cm	📦
P24704	11	3,0	6
P24705	12	3,5	6

P24709 Mini frying pan. Copper color

Mini sartén. Color cobre
Mini poêle. Couleur cuivre

NEW!



REF	Ø cm	H cm	📦
P24709	11	3,0	6
P24710	12	3,5	6

15.1 Stainless steel miniatures

Miniaturas acero inoxidable
Miniatures acier inoxydable



P24410 Mini rectangular roasting pan
Mini rustidera rectangular
Mini rôtissoire rectangulaire



REF	W x D x H cm	
P24410	14,5 x 9,5 x 7,5	12

P24411 Mini square roasting pan
Mini rustidera cuadrada
Mini rôtissoire carrée



REF	W x D x H cm	
P24411	11,5 x 11,5 x 7,5	12

P2440 Mini bucket
Mini cubo
Mini seau



REF	Ø cm	H cm	L	
P24407	7,5	6,5	0,15	72
P24409	9,0	8,5	0,32	72

Stainless steel miniatures 15.1

Miniaturas acero inoxidable
Miniatures acier inoxydable



P24415 Serving cup
Vaso para servir
Tasse de service



REF	Ø cm	H cm	
P24415	8,5	8,5	12

P24412 Hammered serving cup
Vaso para servir hammered
Tasse de service martelée



REF	Ø cm	H cm	
P24412	8,5	8,5	12

P24413 Hammered serving cup. Copper color
Vaso para servir hammered. Color cobre
Tasse de service martelée Couleur cuivre



dishwasher



REF	Ø cm	H cm	
P24413	8,5	8,5	12

P24414 Hammered serving cup. Black color
Vaso para servir hammered. Color negro
Tasse de service martelée Couleur noire



dishwasher



REF	Ø cm	H cm	
P24414	8,5	8,5	12

15.1 Enamelled steel miniatures

Miniaturas acero esmaltado
Miniatures acier émaillé



P99801 Casserole with lid
Cazuela con tapa
Cocotte avec couvercle



NEW!



REF	Ø cm	H cm	
P998010	10	6,0	1
P998012	12	4,0	1
P998014	14	4,5	1

P99901 Shallow casserole without lid
Cazuela baja sin tapa
Cocotte sans couvercle



NEW!



REF	Ø cm	H cm	
P999012	12	6,5	1
P999014	14	7,0	1

P995 Enamelled steel paella pan
Paellera acero esmaltado
Plat à paella acier émaillé



REF	Ø cm	
P995010	10	1
P995016	15	1

P997 Deep enamelled fry pan with handles
Sartén honda esmaltada con asas
Poêle haute avec anses



REF	Ø cm	Lts	
P997014	14	0,4	1
P997016	16	0,5	1

Cast aluminium miniatures 15.1

Miniaturas aluminio de fundición
Miniatures fonte d'aluminium



Made of cast aluminium with high resistance to deformation and excellent thermal performance.

Non-stick interior coating.

Fabricada en aluminio de fundición de gran resistencia a la deformación y con excelentes prestaciones térmicas.

Revestimiento interior antiadherente.

Fabriqué en fonte d'aluminium très résistante à la déformation et doté d'excellentes performances techniques.

Revêtement intérieur antiadhésif.

P151100 Mini black casserole with lid
Mini cazuela negra con tapa
Mini cocotte noire avec couvercle



NEW!

Wooden base included
Base de madera incluida.
Base en bois incluse



REF	Ø cm	H cm	
P151100	10	5	1

P151200 Mini black oval casserole with lid
Mini cazuela oval negra con tapa
Mini cocotte ovale noire avec couvercle



NEW!

Wooden base included
Base de madera incluida.
Base en bois incluse



REF	W x D x H cm	
P151200	13 x 10,5 x 5	1

P151300 Mini white casserole with lid
Mini cazuela blanca con tapa
Mini cocotte blanche avec couvercle



NEW!

Wooden base included
Base de madera incluida.
Base en bois incluse



REF	Ø cm	H cm	
P151300	10	5	1

P151400 Mini white oval casserole with lid
Mini cazuela oval blanca con tapa
Mini cocotte ovale blanche avec couvercle



NEW!

Wooden base included
Base de madera incluida.
Base en bois incluse



REF	W x D x H cm	
P151400	13 x 10,5 x 5	1

P141 Shallow casserole without lid
Cazuela baja sin tapa
Cocotte sans couvercle



REF	Ø cm	H cm	
P141014	14	4,0	1
P141016	16	5,0	1
P141020	20	5,5	1

P151 Deep casserole without lid
Cazuela alta sin tapa
Braisière sans couvercle



Ground base
Fondo torneado
Fond dressé



REF	Ø cm	H cm	
P151012	12	8,5	1
P151014	14	8,5	1
P151016	16	8,0	1

15.1 Castiron miniatures

Miniaturas hierro fundido
Miniatures fonte émaillée



Enamelled cast iron miniatures perfect for individual service and presentations.

Miniaturas en hierro fundido y esmaltado interior, perfectas para servicio individual y presentación.

Miniatures en fonte émaillée (à l'intérieur) idéales pour le service individuel et la présentation.



P23500 Mini fry pan
Mini sartén
Mini poêle ronde



REF	Ø cm	L cm	H cm	
P23500	10,5	16	2,6	12

P23501 Mini fry pan
Mini sartén
Mini poêle ronde



REF	Ø cm	L cm	H cm	
P23501	13,5	21	2,5	12

P23502 Mini deep fry pan
Mini sartén alta
Mini poêle ronde haute



REF	Ø cm	L cm	H cm	
P23502	14	23,5	3,8	12

P23503 Mini squared fry pan
Mini sartén cuadrada
Mini poêle carrée



REF	W x D x H cm	L cm	
P23503	13,6 x 13,6 x 3,6	23,3	12

Cast iron miniatures 15.1

Miniaturas hierro fundido
Miniatures fonte émaillée



P23504 Mini oblong fry pan
Mini sartén rectangular
Mini poêle rectangulaire



REF	W x D x H cm	L cm	
P23504	12,7 x 10,5 x 2,5	18	12

P23508 Oval casserole
Cacerola oval
Mini casserole ovale



REF	W x D x H cm	Lts	
P23508	21,5 x 15,5 x 6,5	0,60	8

P23505 Mini round casserole with lid
Mini cacerola con tapa
Mini cocotte avec couvercle



REF	Ø cm	L cm	H cm	Lts	
P23505	10	13	7,5	0,20	12

P23507 High round casserole with lid
Cacerola alta con tapa
Cocotte haute avec couvercle



REF	Ø cm	H cm	Lts	
P23507	14	9,5	0,70	8

P23506 Mini oval pan with lid
Mini fuente oval con tapa
Mini plateau ovale avec couvercle



REF	W x D x H cm	L cm	
P23506	12 x 8 x 5	15,5	12

P23509 High mini oval pan with lid
Mini fuente oval alta con tapa
Mini plateau ovale haut avec couvercle



REF	W x D x H cm	Lts	
P23509	12,5 x 9,3 x 7,5	0,25	12

15.2 Wood serving boards

Tablas de madera
Planches en bois

Wo
Wood



P41008 Wood serving boards
Tablas de madera
Planches en bois

NEW!



REF	cm	
P41008	28 x 30,5	1

P41009 Wood serving boards
Tablas de madera
Planches en bois

NEW!



REF	cm	
P41009	40,5 x 30,5	1

P41010 Wood serving boards
Tablas de madera
Planches en bois

NEW!



REF	cm	
P41010	51,8 x 20,3	1

VOLLRATH

P41011 Wood serving boards
Tablas de madera
Planches en bois

NEW!



REF	cm	
P41011	36 x 17,5	1

462

pujadas

Taco and sandwich tray 15.2

Tacos y bocadillos presentación
Présentation de Tacos et sandwichs



P41001 Taco tray. 2-3 compartments
Soporte tacos. 2-3 compartimentos
Plateau à Tacos 2-3 compartiments

SS
Stainless
steel



REF	W x D x H cm	
P41001	21 x 10,2 x 5	1

VOLLRATH

P41002 Taco tray. 4-5 compartments
Soporte tacos. 4-5 compartimentos
Plateau à Tacos 4-5 compartiments

SS
Stainless
steel



REF	W x D x H cm	
P41002	36 x 10,2 x 5	1

463

pujadas

P41004 Taco tray with wooden base
Soporte tacos con base de madera
Plateau à tacos avec base en bois

SS
Stainless
steel

Wo
Wood



REF	W x D x H cm	
P41004	44 x 10,8 x 6,5	1

P. 479

Ramekin / Sauce container
Recipiente para salsas
Récipient pour sauces



VOLLRATH

P41003 Sandwich tray. 7 compartments
Soporte bocadillos. 7 compartimentos
Plateau à sandwichs. 7 compartiments

SS
Stainless
steel



REF	W x D x H cm	
P41003	44 x 10,8 x 6,5	1

463

pujadas

15.2 Tin plates display

Llaunas presentación
Plateaux inox présentation



P296415 Stainless steel tray with handles

Llauna inox con asas
Plaque inox avec anses



REF	Base cm	Total W x D x H cm	
P296415	22 x 14	25,5 x 14 x 1,5	1
P296430	22 x 14	25,5 x 14 x 3	1
P296515	26,5 x 23	30 x 23 x 1,5	1
P296530	26,5 x 23	30 x 23 x 3	1
P296615	32 x 24	35,5 x 24 x 1,5	1
P296630	32 x 24	35,5 x 24 x 3	1
P296715	32 x 18	35,5 x 18 x 1,5	1
P296730	32 x 18	35,5 x 18 x 3	1

P296300 Cork base

Base de corcho
Base en liège



dishwasher

REF	W x D x H cm	Suitable for Compatible con Adaptable pour	
P296300	30 x 19 x 3	P296415 - P296430	1
P296400	34,5 x 28 x 3	P296515 - P296530	1
P296500	40 x 29 x 3	P296615 - P296630	1
P296600	40 x 23 x 3	P296715 - P296730	1



IDEA! Ideal for table top service
Ideal para servir en mesa
Idéal pour service de table

Tin plates display 15.2

Llaunas presentación
Plateaux inox présentation

P29680 Stainless steel presentation spatula

Pala presentación en inox
Pelle de présentation en inox



REF	Base cm	Total W x D x H cm	
P29680	23 x 16	38,6 x 16 x 11,5	1

P2965001 Triangular tray

Llauna triangular
Plaque triangulaire



REF	W x D x H cm	
P2965001	29 x 29 x 1,5	1

P29610 Sheet pan with wooden tray with handle

Llauna bandeja presentación rectangular con mango
Plateau de présentation avec manche



REF	Llauna W x D x H cm	Total W x D x H cm	
P29610	22 x 14 x 2	34 x 18 x 3	6

P29600 Sheet pan with wooden tray

Llauna bandeja presentación rectangular
Plateau de présentation



REF	Llauna W x D x H cm	Total W x D x H cm	
P29600	29,5 x 19,5 x 2	33 x 23 x 3	6

P1950 1/1 GN sheet pan

Llauna bandeja gastronorm 1/1 presentación
Plateau GN 1/1 de présentation



GN 1/1



REF	Llauna W x D x H cm	Total L cm	
P195000	48 x 32 x 2	52,5	6

P296 Round sheet pan with wooden tray

Llauna bandeja presentación redonda
Plateau rond de présentation

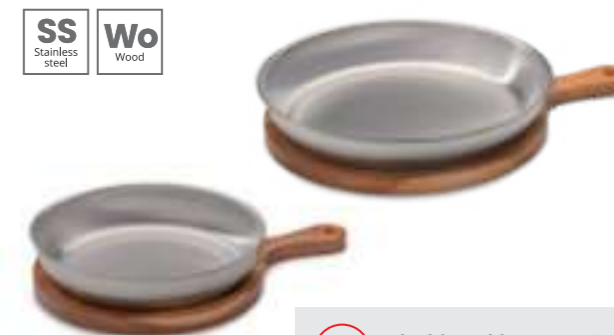

REF	Llauna Ø cm	H cm	Total L cm	H cm	
P29620	20	4,5	31	5,5	6
P29630	26	4,5	37	5,5	6



IDEA! Ideal for table top service
Ideal para servir en mesa
Idéal pour service de table

15.2 Slates

Pizarras
Ardoises



SI
Slate

Wo
Wood



dishwasher

Natural, elegant and exclusive presentation of cold or hot plates.

Presentación natural, elegante y exclusiva de platos fríos o calientes.

Présentation naturelle, élégante et exclusive de plats froids ou chauds.

P28600 Slate and acacia board

Tabla pizarra y acacia
Plateau ardoise et bois



REF	W x D x H cm	
P28600	33 x 23 x 1,5	1

P28610 Slate and acacia board

Tabla pizarra y acacia
Plateau ardoise et bois



REF	W x D x H cm	L cm	
P28610	26 x 18 x 1,5	34	1

P28620 Slate and acacia board

Tabla pizarra y acacia
Plateau ardoise et bois



REF	Ø cm	L cm	H cm	
P28620	21,0	31	1,5	1
P28621	26,5	37	1,5	1

See products on

Ver productos en / Voir produits en page

P. 92

Display tray

Bandeja presentación
Plateau présentation



Slates 15.2

Pizarras
Ardoises

SI
Slate

P28202 Slate serving tray
Pizarra presentación
Ardoise presentation

BEST
SELLER



Polished edges
Cantos pulidos
Coins biseautés

Rubber feet
Pies espumados
Pieds mousse

4-5 mm
Thickness
Espesor
Epaisseur



REF	cm	
P28202	20 x 20	24
P28252	25 x 25	16
P28303	30 x 30	12
P28302	30 x 20	16
P28403	40 x 30	10

P28501 Slate serving tray
Pizarra presentación
Ardoise presentation



REF	cm	
P28501	25 x 25	1
P28502	30 x 30	1
P28503	30 x 20	1
P28504	40 x 30	1

P28505 Slate serving tray
Pizarra presentación
Ardoise presentation



REF	Ø cm	
P28505	20	1
P28506	30	1

Natural edges
Cantos naturales
Coins naturels

Rubber feet
Pies espumados
Pieds mousse

Rough surface
Superficie rústica
Surface rustique

5-6 mm
Thickness
Espesor
Epaisseur

15.2 Natural bamboo

Bambú natural
Bambou naturel



NATURAL
FIBERS

Natural bamboo presentation range for the most demanding hotels and restaurants.

Gama presentación bambú natural para los más exigentes.

Gamme de présentation bambou naturel plus exigeants.



P10051 Bamboo sushi board
Tabla bambú presentación sushi
Planche bamboú présentation sushi



REF	W x D x H cm	
P100511	24 x 15 x 3	24
P100512	27 x 18 x 3	24

P10052 Curved bamboo sushi board
Tabla curvada bambú sushi
Planche incurvée bambou présentation sushi



REF	W x D x H cm	
P100520	21 x 12 x 2,5	36
P100521	24 x 15 x 3	24
P100522	27 x 18 x 3	24

P10060 Sushi boat presentation
Barco presentación sushi
Bateau présentation sushi



REF	W x D x H cm	
P100600	50 x 20 x 31	6
P100601	70 x 25,5 x 45	8

Natural bamboo 15.2

Bambú natural
Bambou naturel



P10054 Round bamboo steamer
Vaporeira bambú redonda
Cuit vapeur bambou rond



Without lid
Sin tapa
Sans couvercle

REF	Ø cm	H cm	
P100540	10	4,0	50
P100541	13	5,0	224
P100542	15	5,0	144
P100543	21	5,0	72
P100544	27	5,5	44

P10055 Round steamer lid
Tapa vaporeira redonda
Couvercle cuit vapeur rond



REF	Ø cm	H cm	
P100550	10	3,0	500
P100551	13	3,5	272
P100552	15	3,5	204
P100553	21	4,0	102
P100554	27	4,0	60

P10053 Sushi rectangular tray
Bandeja rectangular presentación sushi
Plateau rectangulaire présentation sushi



REF	W x D x H cm	
P100530	33 x 22,5 x 8	6
P100531	42 x 32 x 8,5	6

P10057 Bamboo tong
Pinza bambú
Pince bambou



REF	L cm	
P100570	20,0	780
P100571	25,5	504
P100572	30,0	444

15.2 Baskets and breadbaskets

Paneras y cestas
Paniers et corbeilles

Mt
Metal



P876001 Metal cone basket
Cesta cono metal
Panier métal cône

Mt
Metal

NEW!



REF	cm	H cm	
P876001	13 x 13	18	1

P876002 Metal cone basket 1 ramekin
Cesta cono metal 1 ramekin
Panier métal cône 1 ramequin

Mt
Metal

NEW!

Ramekin not included
Ramekin no incluido
Ramequin non inclus

Ramekin compatible
Compatible con ramekin
Compatible ramequin
P41007, P41013, P41014,
P41016, P41017, P41019 y
P41020

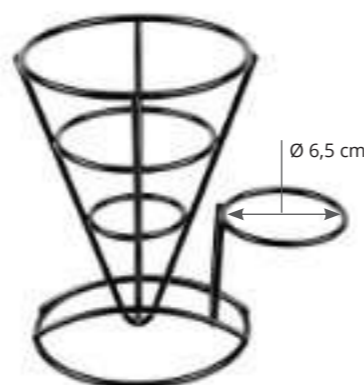

REF	cm	H cm	
P876002	19 x 13	18	1

P876003 Metal cone basket 2 ramekins
Cesta cono metal 2 ramekines
Panier métal cône 2 ramequins

Mt
Metal

NEW!

Ramekin not included
Ramekin no incluido
Ramequin non inclus

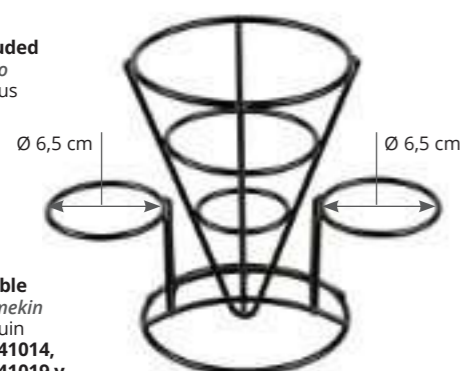

Ramekin compatible
Compatible con ramekin
Compatible ramequin
P41007, P41013, P41014,
P41016, P41017, P41019 y
P41020

REF	cm	H cm	
P876003	25 x 13	18	1

See products on
Ver productos en / Voir produits en page

P. 479

Ramekins
Ramekins
Ramequins



Baskets and breadbaskets 15.2

Paneras y cestas
Paniers et corbeilles

Mt
Metal

P591001 Round metal basket
Cesta metal redonda
Panier métal rond

Mt
Metal

NEW!



REF	Ø cm	H cm	
P591001	26,5	5	1

P591002 Oval metal basket
Cesta metal ovalada
Panier métal ovale

Mt
Metal

NEW!



REF	W x D x H cm	
P591002	22,5 x 15 x 4,5	1

P591003 Rectangular metal basket
Cesta metal rectangular
Panier métal rectangulaire

Mt
Metal

NEW!



REF	W x D x H cm	
P591003	23 x 10 x 4,5	1

P591004 Rectangular metal basket
Cesta metal rectangular
Panier métal rectangulaire

Mt
Metal

NEW!



REF	W x D x H cm	
P591004	23 x 17,5 x 4,5	1

P591005 Round metal basket
Cesta metal redonda
Panier métal rond

Mt
Metal

NEW!



REF	Ø cm	H cm	
P591005	20,5	13	1

Baskets and breadbaskets 15.2

Paneras y cestas
Paniers et corbeilles



P100816 Brown bread basket
Cesta pan marrón
Corbeille à pain marron

Washable
Se puede lavar
Peuvent se laver



P100807

REF	W x D x H cm	
P100816	13,0 x 13,0 x 15	12
P100807	17,5 x 17,5 x 15	12
P100836	26,5 x 26,5 x 12	12

P100808 Grey bread basket
Cesta pan gris
Corbeille à pain gris

Washable
Se puede lavar
Peuvent se laver



P100808



P100838

REF	W x D x H cm	
P100808	13,0 x 13,0 x 15	12
P100827	17,5 x 17,5 x 15	12
P100838	26,5 x 26,5 x 12	12



P100817 Black bread basket
Cesta pan negra
Corbeille à pain noir

Washable
Se puede lavar
Peuvent se laver



P100826

REF	W x D x H cm	
P100817	13,0 x 13,0 x 15	12
P100826	17,5 x 17,5 x 15	12
P100837	26,5 x 26,5 x 12	12

15.2 Baskets and breadbaskets

Paneras y cestas
Paniers et corbeilles



P100740 Bread basket
Cesta pan
Corbeille à pain



P100740

REF	W x D x H cm	
P100740	29 x 29 x 47,5	12

P100741 Bread basket
Cesta pan
Corbeille à pain



P100741

P100742

REF	W x D x H cm	
P100741	36 x 30 x 21 / 39	6
P100742	Ø 29 x 21 / 39	6

P10074 Bread basket
Cesta pan
Corbeille à pain



P100780

REF	Ø cm	H cm	
P100780	35	35	12

P10075 Slated bread basket
Cesta redonda inclinada
Corbeille ronde inclinée



REF	Ø cm	H cm	
P100754	36	10 / 20	6
P100755	40	13 / 23	6

P10076 Slated rectangular basket
Cesta rectangular inclinada
Corbeille rectangulaire inclinée



REF	W x D x H cm	
P100760	40 x 28 x 6 / 10	12
P100761	58 x 38 x 8 / 12	6

P10077 Two compartment rectangular basket
Cesta rectangular dos compartimentos
Corbeille rectangulaire deux compartiments



REF	W x D x H cm	
P100770	49 x 31 x 10 / 14,3	6

Baskets and breadbaskets 15.2

Paneras y cestas
Paniers et corbeilles



P10079 Round basket
Cesta redonda
Corbeille ronde



REF	Ø cm	H cm	
P100792	24	5,5	60

P10080 Round basket
Cesta redonda
Corbeille ronde



P100804

P100803

P100805

REF	Ø cm	H cm	
P100803	18	6,0	48
P100804	23	6,0	48
P100805	25	6,0	48

P10081 Round basket
Cesta redonda
Corbeille ronde



REF	Ø cm	H cm	
P100813	18,5	6,0	84
P100814	23	6,0	84

P10082 Round basket
Cesta redonda
Corbeille ronde



REF	Ø cm	H cm	
P100820	18,5	6,0	84
P100821	23	6,0	84

P10090 Oval basket
Cesta oval
Corbeille ovale



REF	W x D x H cm	
P100900	30 x 23,5 x 7,5	36

15.2 Baskets and breadbaskets

Paneras y cestas
Paniers et corbeilles



P10084 Rectangular basket
Cesta rectangular
Corbeille rectangulaire



REF	W x D x H cm	
P100840	21,5 x 18 x 8	84
P100841	26 x 20 x 7,5	48

P10085 Rectangular basket
Cesta rectangular
Corbeille rectangulaire



REF	W x D x H cm	
P100851	40 x 28,5 x 7	24

P10086 Rectangular basket
Cesta rectangular
Corbeille rectangulaire



REF	W x D x H cm	
P100860	37 x 27 x 7	24
P100861	46 x 34 x 7	24
P100862	46 x 34 x 12	12

P10087 Rectangular basket
Cesta rectangular
Corbeille rectangulaire



REF	W x D x H cm	
P100871	42 x 30 x 7	24

P10088 Oval basket
Cesta oval
Corbeille ovale



REF	W x D x H cm	
P100880	18 x 12 x 6,5	60
P100881	23,5 x 15 x 7	60
P100882	28 x 14,5 x 7,5	36

P10089 Oval basket
Cesta oval
Corbeille ovale



REF	W x D x H cm	
P100890	19 x 13 x 7	48
P100891	25 x 15 x 8	60
P100892	29 x 19 x 10	60

Baskets and breadbaskets 15.2

Paneras y cestas
Paniers et corbeilles



P10093 Cutlery dispenser
Cesta para cubiertos
Corbeille à couverts



REF	W x D x H cm	
P100931	30 x 11 x 7	96
P100932	30 x 11 x 7	96

P10094 Cutlery dispenser
Cesta para cubiertos
Corbeille à couverts



REF	Ø cm	H cm	
P100940	13	14	36

P10095 Rectangular buffet basket
Cesta buffet rectangular
Corbeille rectangulaire buffet



GN 1/1



* Lid
Tapa
Couvercle

REF	cm	Total H cm	Base H cm	
P100950	53 x 31,5	26,0	8,5	12
P100951	53 x 31,5	26,0	8,5	12
P100955*				6

P10096 Round buffet basket
Cesta buffet redonda
Corbeille ronde buffet



* Lid
Tapa
Couvercle

REF	Ø cm	H cm	
P100960	40	30	24
P100965*			6

15.2 Place mats

Manteles individuales
Sets de table

PVC

Place mats made of PVC + polyester.
To clean please use a damp sponge or cloth.

Manteles individuales fabricados en PVC + poliéster. Para su limpieza se aconseja usar una esponja o trapo húmedo.

Sets de table fabriqués en PVC + polyester.
Nettoyer à l'aide d'une éponge ou un chiffon humide.

P92605 DECO place mats
Manteles individuales DECO
Sets de table DECO

PVC

REF	cm	
P926051	45 x 30	20
P926052	45 x 30	20
P926053	45 x 30	20

PACK 6 u.

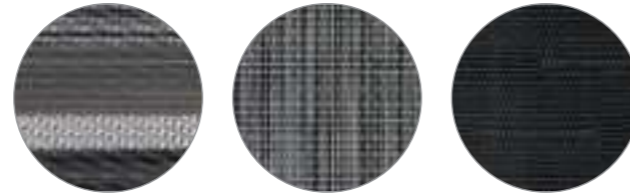

Brown&Black Lines
Lineas marrones-negras
Lignes marrons et noirs
P926051

Brown&Black
Marrón-negro
Marron et noir
P926052

Black
Negro
Noir
P926053

P9260 Place mat fine band
Mantel individual trama fina
Set de table maille fine

REF	cm	
P926006	45 x 30	20
P926007	45 x 30	20
P926008	45 x 30	20
P926009	45 x 30	20



Brown
Marrón
Marron
P926006



Coffee
Café
Café
P926007



Black&White
Negro-Blanco
Noir et blanc
P926008



Green
Verde
Vert
P926009

P926 Place mat wide band
Mantel individual trama gruesa
Set de table maille épaisse

REF	cm	
P926002	45 x 30	20
P926003	45 x 30	20
P926004	45 x 30	20
P926005	45 x 30	20
P926010	45 x 30	20
P926011	45 x 30	20
P926012	45 x 30	20



Orange
Naranja
P926002



Brown&Silver
Marrón-Plata
Marron et Argent
P926010

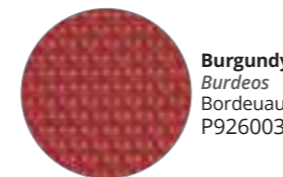

Burgundy
Burdeos
Bordeaux
P926003



Brown&Gold
Marrón-Dorado
Marron et Doré
P926011



Black
Negro
Noir
P926004



Silver
Plateado
Argent
P926012



Brown&Black
Marrón-Negro
Marron et noir
P926005

Flared sauce cups 15.3

Salseras
Saucières

P4100 Ramekin / Sauce container
Recipiente para salsas
Récipient pour sauces

SS
Stainless steel

NEW!



PACK 12 u.

REF	Ø cm	H cm	ml	
P41005	6,2	2,75	45	12
P41006	5,8	4,50	75	12
P41007	7,4	5,20	135	12

P4101 Ramekin / Sauce container
Recipiente para salsas
Récipient pour sauces

PET

NEW!



PACK 12 u.

REF		Ø cm	H cm	ml	
P41012	white	6,0	3,5	45	12
P41013	blanco	7,0	3,5	60	12
P41014	blanc	7,5	4,0	90	12
P41015	black	6,0	3,5	45	12
P41016	negro	7,0	3,5	60	12
P41017	noir	7,5	4,0	90	12
P41018	transparent	6,0	3,5	45	12
P41019	transparente	7,0	3,5	60	12
P41020	transparent	7,5	4,0	90	12

P623 Snack bowl set or sauce bowl set
Portasalados o portasalsas
Ensemble bols pour snacks ou sauces

SS
Stainless steel



REF	UNI.	Ø cm/U	ml/U	
P623003	3	9	200	25

P333 Gravy boat
Salsera
Saucière

SS
Stainless steel



REF	L	
P333010	0,10	72
P333020	0,20	36
P333035	0,35	24

15.3 Table accessories

Complementos de mesa
Accessoires de table



P638003 Table caddy. 3 Compartments
Caddy de mesa. 3 Compartimentos
Caddy de table. 3 compartiments

Galvanised steel
Acero galvanizado
Acier galvanisé

Wooden handle
Asa de madera
Manche en bois



dishwasher



REF	W x D x H cm	📦
P638003	26 x 10 x 12	6

P638004 Table caddy. 4 Compartments
Caddy de mesa. 4 Compartimentos
Caddy de table. 4 compartiments

Galvanised steel
Acero galvanizado
Acier galvanisé

Wooden handle
Asa de madera
Manche en bois



dishwasher



REF	W x D x H cm	📦
P638004	26 x 18 x 12	6

Table accessories 15.3

Complementos de mesa
Accessoires de table

P96700 Pepper mill-salt mill. Wooden
Molinillos pimienta y sal. Madera
Moulin à poivre et sel. Bois



REF	H cm	📦
P967007	12,5	1
P967008	15,0	1
P967009	19,5	1

P967 Pepper mill-salt mill. Acrylic
Molinillos pimienta y sal. Acrílico
Moulin à poivre et sel. Acrylique



REF	Type / Tipo	H cm	📦
P967001	A	15,5	48
P967002	A	20,0	48
P967003	A	23,0	48
P967004	B	15,5	48
P967005	B	20,0	48
P967006	B	23,0	48

P630 Number card holder
Soporte para número "banquete"
Support numéro "banquet"



REF	H cm	📦
P630010	10	50
P630020	20	50
P630030	30	50
P630040	40	50

P632 Table number
Número de mesa
Numéro de table

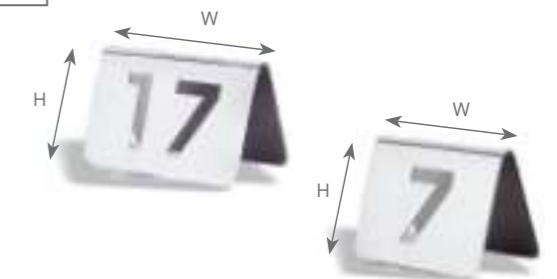

N. 1 - N. 30 ** number with 2 digits. * number with 1 digit.
** número de 2 dígitos. * número de 1 dígito.
** numero de 2 chiffres. * numero d'un seul chiffre.

REF	W x H cm	📦
P63200 + NUM*	6,4 x 5,6	1
P6320 + NUM**	7,6 x 5,6	1

P633 "Reserved" table sign
Placa "Reservado"
Plaque "reserve"



REF	Text	W x H cm	📦
P633000	RESERVADO	10 x 5	300
P633002	RESERVED	10 x 5	200
P633003	RESERVE	10 x 5	310

P634 "Non-smoking" sign
Placa "Prohibido fumar"
Plaque "Défense de fumer"



REF	W x H cm	📦
P634000	7,6 x 5,6	100

15.3 Table accessories

Complementos de mesa
Accessoires de table

P969 Stand for tray
Soporte elevador
Support pour plateau



REF	Ø cm	H cm	
P969000	25 / 20	19,0	12

P968 Carry-skewers
Porta pinchos
Porte-brochettes



REF	Ø cm	H cm	
P968000	22	46	1

P8621 Non slip oval serving tray
Bandeja oval antideslizante
Plateau antidérapant forme ovale



Black color
Color negro
Couleur noir

REF	cm	
P862100	68 x 56	6

P9681 Skewer
Pincho
Brochette



Price 12 units box.
Precio caja 12 unidades.
Prix colis 12 unités.

REF	L cm	
P968125	25	1
P968130	30	1
P968135	35	1

P874 Bill spike
Pinchanotas
Epingle porte-tickets



REF	Ø cm	H cm	
P874000	9	22	50

P863 Large tray holder
Soporte para bandejas de gran tamaño
Support pour grands plateaux



Serving tray not included.
No incluye bandeja.
Plateau non inclus.

REF	W x D x H cm	
P863000	47 x 47 x 76,5	6

Table accessories 15.3

Complementos de mesa
Accessoires de table



P650 St/Steel table-tidy
Papelera sobremesa acero inox
Receptacle à déchets de table



REF	Ø cm	H cm	
P650000	12	21	36

P638 Water ashtray
Cenicero de agua
Cendrier à eau



REF	Ø cm	H cm	
P638000	11	5,5	100

P625 Table crumber
Pala recogemigas
Pelle ramasse-miettes

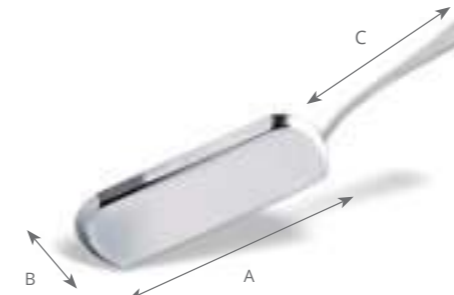

REF	A x B x C cm	
P625000	18 x 7 x 12,5	144

P357 Napkin holder
Servilletero
Porte-serviettes



REF	H x W x D cm	
P357000	13 x 9,8 x 10	72

P639 Deep ashtray
Cenicero hondo
Cendrier profond



REF	H x W x D cm	
P639000	2,5 x 12,5 x 12,5	200

See products on
Ver productos en / Voir produits en page

P. 383

Melamine
Melamina
Mélamine



15.3 Menu holders

Portamenús
Porte-menus

- Made of PVC.
- Pockets on each back cover.
- For DIN A4 and DIN A5 sheets.

- Fabricado en PVC.
- Bolsillos en contratapa interior.
- Para hojas DIN A4 y DIN A5.

- Fabriqué en PVC.
- Poches avec couverture intérieure.
- Pour feuilles DIN A4 et DIN A5.

P2004 Elegance menu holder

Portamenús Elegance
Porte-Menus Elegance

PVC



Up to 10 pages: cover back + 4 double inner pages + back cover front.

Para 10 páginas: 4 fundas dobles + 2 laterales.

Pour 10 pages: 4 feuilles plastiques doubles + 2 latérales.

REF	cm	Colour / Color	
P20041	33 x 24	Burdeos / Burgundy / Bordeaux	1
P20042	33 x 24	Negro / Black / Noir	1

P636 Menu holder

Portamenús
Porte-menu de table

SS
Stainless steel



REF	H cm	
P636000	2	200

P20066 Bill Holder

Porta facturas
Porte-addition



REF	W x H cm	Colour / Color	
P20066	24,5 x 17	Negro / Black / Noir	1
P20069	20 x 13,5	Negro / Black / Noir	1

P20050 Elegance Bill holder

Porta blocs Elegance
Porte-addition Elegance

PVC



REF	cm	Colour / Color	
P20050	23 x 13	Negro / Black / Noir	72

P637 Bill holder

Platillo cambio
Porte-addition

SS
Stainless steel



REF	cm	
P637000	15,5 x 11	200
P637100	21,5 x 12,5	120

P635 Card holder

Portatarjetas
Porte-cartes

SS
Stainless steel

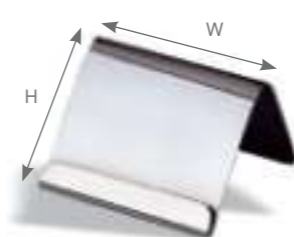

REF	W x H cm	
P635000	6,2 x 5,2	500

Food & table service 15.4

Servicio de mesa
Arts de table

Plate Covers

Tapas para platos
Couvercles à assiette

Plate covers keep food at its ideal serving temperature for improved customer satisfaction. Hemmed finger hole.

Las tapas para platos mantienen la comida a la temperatura ideal para servir. Se ofrecen con orificio central.

Les couvre-assiettes maintiennent les aliments à la température idéale de service pour améliorer la satisfaction du client. Trou ourlé pour passer le doigt.



62300 Stainless Steel Plate Covers

Tapas Acero inoxidable para platos
Inox couvercles à assiette

SS
Stainless steel

Stackable
Apilable
Empilable



Satin-finish keeps covers looking better longer
El acabado satinado mantiene más tiempo el buen aspecto de las tapas
Fini satin pour un attrait durable

REF	For / Para / Pour Ø cm	H cm	
62300	22,9 - 23,2	5,9	12
62301	23,3 - 23,5	5,9	12 NEW
62303	24,0 - 24,1	5,9	12
62305	24,6 - 24,8	5,9	12 NEW
62309	25,9 - 26,0	5,9	12 NEW
62311	26,5 - 26,7	5,9	12 NEW
62312	26,8 - 27,0	5,9	12
62313	27,1 - 27,3	5,9	12
62314	27,5 - 27,6	5,9	12 NEW
62315	27,8 - 27,9	5,9	12
62318	28,1 - 28,3	5,9	12
62321	29,1 - 29,2	5,9	12
62322	29,4 - 29,5	7,1	12 NEW
62323	29,7 - 29,8	7,1	12 NEW
62325	30,3 - 30,5	7,1	12 NEW
62326	30,6 - 30,8	5,9	12
62327	31,0 - 31,1	7,1	12 NEW
62328	31,3 - 31,4	7,1	12 NEW

918 Plastic Plate Covers

Tapas plástico para platos
Plastique couvercles à assiette

PC
Polycarbonate

+ 93°C

Stackable
Apilable
Empilable

Clear
Transparente
Transparent

Dishwasher
Lavavajillas
Lave-vaisselle



REF	For / Para / Pour Ø cm	H cm	
918-13	21,6 - 23,2	6,7	12
1078-13	26,7 - 27,0	7,0	12
1100-13	28	7,2	12 NEW
1200-13	30,50	7,2	12 NEW

Ask about other available sizes
Consultar otras medidas disponibles
Consulter autres dimensions disponibles

16 Bar & coffee

Bar y cafetería
Bar et cafétéria



16.1 BEVERAGE TROLLEY 488

CARRO BEBIDAS/ CHARIOT BOISSONS

Cocktailrolley/Carro cocktail / Chariot cocktail	488
Liquortrolley/Carro licor / Chariot à liqueurs	490

16.2 BAR 491

Wine Buckets/ Cubiteras / Seaux à champagne	491
Cocktail Service/ Cocteleria / Cocktail	496
Bar Mats/ Alfombras para bar / Tapis de bar	498
Condiment Dispensers/ Distribuidor de condimentos / Distributeur de condiments	499
Wine Complements/ Complementos de vino / Accessoires de vin	500
Trays/ Bandejas / Plateaux	501

16.3 TEA & COFFEE SERVICE 502

TÉ Y CAFETERÍA / THÉ ET CAFÉTÉRIA

Planet	502
Cosmos	504
Atlantis	504
Tea Pots/ Teteras / Théières	505

16.4 BEVERAGE SERVICE 506

SERVICIO DE BEBIDAS/ SERVICE À BOISSONS

Servers/ Servidores / Verseuses	506
Pitchers/ Jarras / Pichets	508

16.5 LIDS AVERS AND CUP DISPENSERS 510

DISPENSADORES DE TAPAS Y VASOS
DISTRIBUTEUR DE COUVERCLES ET GOBELETS

16.1 Cocktail trolley

Carro cocktail / Chariot cocktail

Trolley with an innovative and versatile design, with multiple storage spaces and a large work area.

Carro de diseño innovador y versátil, con múltiples espacios de almacenaje y una amplia zona de trabajo.

Chariot au design innovant et polyvalent, avec de multiples espaces de rangement et un grand espace de travail.

Carbon steel structure with anti-rust coating and satin black paint.

Estructura de acero al carbono con recubrimiento antioxidante y pintura negra satinada.

Structure en acier au carbone avec revêtement antioxydant et peinture noire satinée.

NEW!



It can be customized with a logo.
Se puede personalizar con logo.
Personnalisable avec logo.

Elements of the work area in stainless steel.

Elementos del área de trabajo en acero inoxidable.

Éléments de la zone de travail en acier inoxydable.

Solid anti-humidity board with oak finish.

Tablero macizo antihumedad acabado roble.

Panneau massif anti-humidité finition chêne.

Drawer with metal runners

Cajón con guías metálicas

Tiroir avec guides métalliques



Revolving casters, two with brakes
Ruedas giratorias, dos con frenos
Roues giratoires, deux avec freins

5 rails for hanging glasses

5 railes para colgar copas
5 rails pour suspendre les verres



2 speed rails

Cocktail trolley 16.1

Carro cocktail

Chariot cocktail

Elements included:

Elementos incluidos:

Éléments inclus :

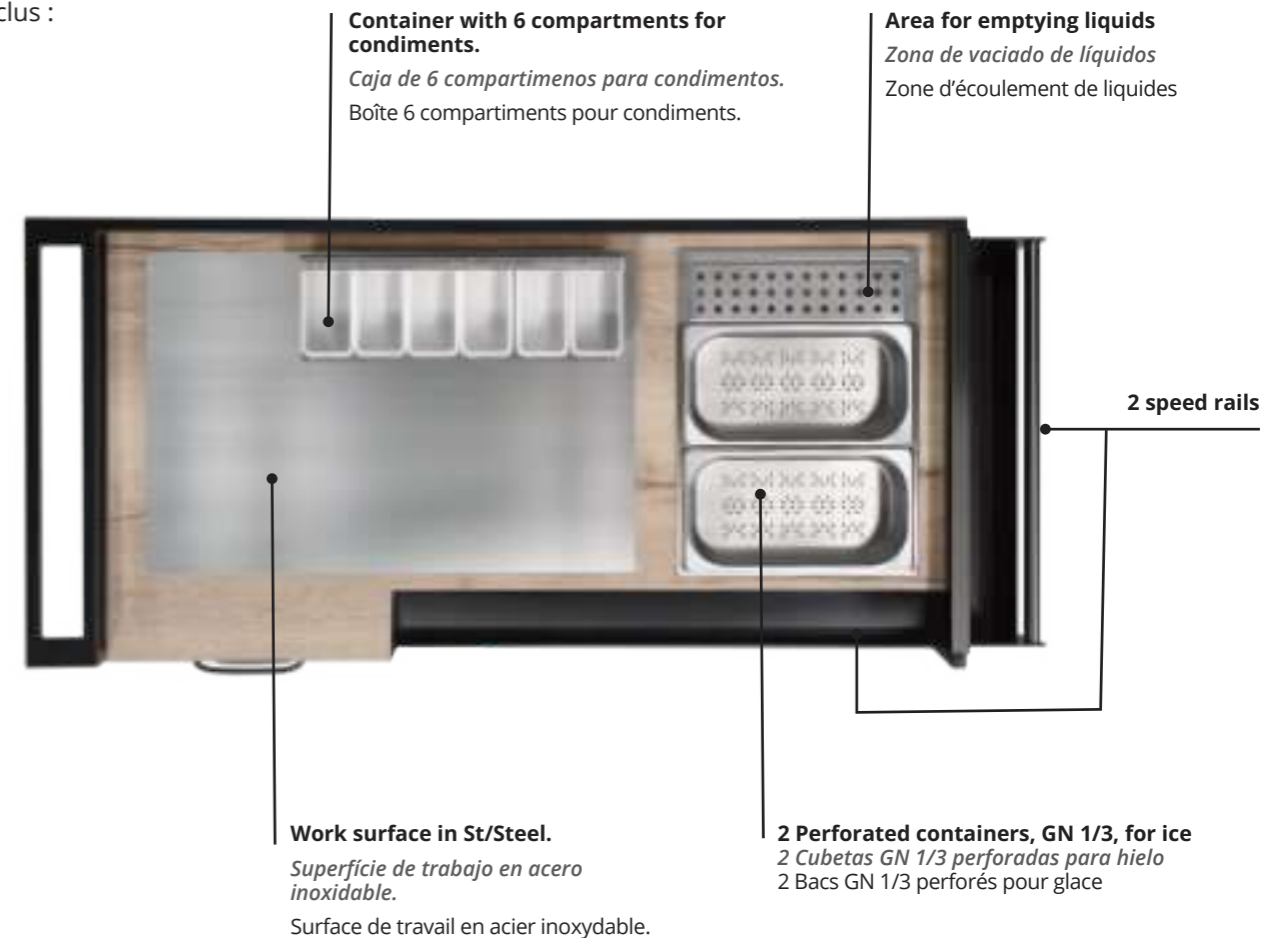

Container with 6 compartments for condiments.

Caja de 6 compartimentos para condimentos.
Boîte 6 compartiments pour condiments.

Area for emptying liquids

Zona de vaciado de líquidos
Zone d'écoulement de liquides

2 speed rails

Work surface in St/Steel.

Superficie de trabajo en acero inoxidable.

Surface de travail en acier inoxydable.

2 Perforated containers, GN 1/3, for ice

2 Cubetas GN 1/3 perforadas para hielo
2 Bacs GN 1/3 perforés pour glace

P90910 Cocktail trolley with stainless steel work module

Carro cocktail con área de trabajo

Chariot à cocktails avec zone de travail



REF
P90910

W x D x H cm
132,5 x 63 x 98,5

1

P90911 Hanging bottle rack

Botellero colgante

Porte-bouteilles suspendu



Maximum 3 per trolley
Máximo 3 por carro.
Maximum 3 par chariot.

REF
P90911

W x D x H cm
59,5 x 12 x 23,5

1

16.1 Liquor trolley

Carro licor
Chariot à liqueurs



NEW!

Carbon steel structure with anti-rust coating and satin black paint.

Estructura de acero al carbono con recubrimiento antioxidante y pintura negra satinada.

Structure en acier au carbone avec revêtement antioxydant et peinture noire satinée.

REF	W x D x H cm	
P90930	91,5 x 63 x 98	1

3 speed rails

Solid anti-humidity board with oak finish.

Tablero macizo antihumedad acabado roble.

Panneau massif anti-humidité finition chêne.

3 rails for hanging glasses

3 railes para colgar copas
3 rails pour suspendre les verres

Area for rocks glasses.
20-glass capacity.

Zona para vasos de licor.
Capacidad para 20 vasos.
Zone pour verres à liqueur.
Capacité pour 20 verres.

Shelves for mixers

Estanterías para mixers
Étagères pour mixers



Wine Buckets 16.2

Cubiteras
Seaux à champagne



P972 Champagne bucket
Cubo champán
Seau à champagne

SS
Stainless steel



dishwasher

NEW!



REF	Ø cm	H cm	Colour / Color	
P972201	21	20	Gold / oro / or	1
P972202	21	20	Black / negro / noir	1
P972203	21	20	Copper / cobre / cuivre	1

Sophistication and durability
Sofisticación y durabilidad
Sophistication et durabilité

Elevate the presentation of your drinks. Add a touch of sophistication with these ice buckets made from stainless steel, painted in stylish colours on the outside.

Eleva la presentación de tus bebidas. Añade un toque de sofisticación con estas cubiteras realizadas en acero inoxidable y pintadas en elegantes colores por la parte exterior.

Sublimez la présentation de vos boissons. Apportez une note de sophistication aux seaux à glace en acier inoxydable avec revêtements extérieurs élégants.

P976 Hammered champagne bucket with handles
Cubo champán hammered con asas
Seau à champagne martelé avec poignées

SS
Stainless steel

NEW!



REF	Ø cm	H cm	
P976210	21	20	1

47620 Champagne bucket with fixed handles
Cubo champán con asas fijas
Seau à champagne à poignées fixes

SS
Stainless steel

NEW!



REF	Ø cm	H cm	
47620	21	19,7	1

16.2 Wine Buckets

Cubiteras
Seaux à champagne



P311F71 Conical champagne bucket with rings
Cubo champán cónico con anillas
Seau à champagne conique à anneaux



REF	Ø cm	H cm	
P311071	20	19,5	1

P311F2 Champagne bucket with fixed handles
Cubo champán con asas fijas
Seau à champagne à poignées fixes



REF	Ø cm	H cm	
P311002	18	19	1

P311F6 Champagne bucket with rings
Cubo champán con anillas
Seau à champagne à anneaux



REF	Ø cm	H cm	
P311006	18	19	1

P326 Champagne bucket two bottles
Cubo champán dos botellas
Seau à champagne deux bouteilles



REF	Ø cm	H cm	
P326000	25	22	1

P9762 Conical champagne bucket with handles
Cubo champán cónico con asas
Seau à champagne conique avec poignées



REF	Ø cm	H cm	
P976200	21	20	24

P9763 Conical champagne bucket with rings
Cubo champán cónico con anillas
Seau à champagne conique à anneaux



REF	Ø cm	H cm	
P976300	19	19	24

Wine Buckets 16.2

Cubiteras
Seaux à champagne



P312 Ice bucket with separative disk
Cubo para hielo con disco separador
Seau à glaçons avec disque de séparation



REF	Ø cm	H cm	
P312000	11	13	50

P974 Double wall insulated cooler
Enfriador isotérmico doble pared
Rafraîchisseur isotherme double paroi



REF	Ø cm	H cm	
P974000	10,5	20	24

P310 Ice cube bowl
Cubitera tipo ensaladera
Vasque



REF	Ø cm	H cm	Lts	
P310000	40	24,5	13	1

P327 Ice cube bowl
Cubitera tipo ensaladera
Vasque



REF	Ø cm	H cm	Lts	
P327000	35	25	10	1

P3110 St/Steel bucket-holder stand
Pie portacubos acero inox
Pied porte-seau

* Suitable for references
Compatible con los modelos
Compatible avec les références
P311.F2, P311.F6, P311.F71

** For 2 bottles bucket
Para cubitera 2 botellas
Pour seau à champagne
2 bouteilles



REF	Ø cm	H cm	
P311004*	18	67,5	1
P311020**	22	69,0	1

47611 St/Steel bucket-holder stand
Pie portacubos acero inox
Pied porte-seau



REF	Ø cm	H cm	
47611	19,5	60	1

16.2 Wine Buckets

Cubiteras
Seaux à champagne



dishwasher

P988400 Plastic champagne bucket
Cubitera de plástico
Seau à champagne



REF	Ø cm	H cm	
P988400	21	21,5	6

P988500 Bi-color plastic champagne bucket
Cubitera bicolor plástico
Seau à champagne bicolore



REF	Ø cm	H cm	
P988500	19	21	1

P988600 Oval plastic champagne bucket
Cubitera ovalada plástico
Seau à champagne ovale



REF	W x D x H cm	
P988600	32,5 x 23,5 x 22	1

P988700 Plastic champagne bucket
Cubitera de plástico
Seau à champagne



REF	Ø cm	H cm	
P988700	19,5	21	1

VOLLRATH

494

pujadas

Wine Buckets 16.2

Cubiteras
Seaux à champagne

P988900 Oval plastic champagne bucket
Cubitera ovalada plástico
Seau à champagne ovale



REF	W x D x H cm	
P988900	44,5 x 41,5 x 25	1

P9881 Conical acrylic champagne bucket
Cubitera cónica acrílica
Seau à champagne conique



REF	Ø cm	H cm	
P988100	20	18,5	12

P9882 Oval acrylic champagne bucket
Cubitera ovalada acrílica
Seau à champagne ovale



*3 BOTTLES
*3 BOTELLAS
*3 BOUTEILLES

REF	W x D x H cm	
P988200	27 x 20 x 20	12
P988300*	35 x 26 x 27	6

P646 Champagne bucket holder
Soporte de mesa para cubo champán
Support de table pour seau à champagne



VOLLRATH

495

P990 Wine cooler
Manta enfriadora
Rafrichisseur

Reversible:
burgundy and silver

Reversible:
burdeos y plata

Réversible:
bordeaux et argenté



REF	cm	
P990000	35 x 18	55

Suitable with all champagne bucket but:
Compatible con todos los modelos de cubos champán excepto con:
Compatible avec tous les modèles sauf :
ref. P326

REF	Ø cm	cm	
P646000	18	52 x 17	4

pujadas

16.2 Cocktail Service

Cocteleria
Cocktail



P330 Shaker

Coctelera
Shaker



REF	H cm	Lts	
P330035	18,0	0,35	72
P330050	20,5	0,50	72
P330070	23,5	0,70	48

46793 Bar shaker

Coctelera
Shaker



Mirror-finished stainless steel. Reinforced bases
Acero inoxidable brillante. Bases reforzadas
Acier inoxydable ultra-brillant. Bases renforcées

REF	Ø cm	H cm	ml	
46793	9,2	17,8	900	12
46791	8,64	11,4	455	12

48070 Malt cup

Vaso para malteado
Verre à milkshake



NEW!

Reinforced base. Ideal for malts, milkshakes, ice cream and more.
Bases reforzadas. Ideal para maltas, batidos, helados y más.
Bases renforcées. Idéal pour les malts, les milkshakes, la crème glacée et plus encore.

REF	Ø cm	H cm	ml	
48070	10,2	17,1	900	12

See products on [P. 457](#)
Ver productos en / Voir produits en page



Cocktail Service 16.2

Cocteleria
Cocktail



P388 Ice tong

Pinza hielo
Pince à glace



REF	L cm	
P388018	18,5	100

47104 Ice tong

Pinza hielo
Pince à glace



REF	L cm	
47104	15,9	12

46790 Bar scoop

Cuchara de bar
Pelle à bar



NEW!

Sturdy handle provides a comfortable, reliable grip.
El mango resistente proporciona un agarre cómodo y fiable.
La poignée robuste offre une prise en main confortable et fiable.

REF		
46790		24

46787 Cocktail strainer

Colador para cócteles
Passoire à cocktail

NEW!

Four prongs provide stability.
Removable spring ensures easy and efficient cleaning.

Las cuatro puntas ofrecen estabilidad. El resorte extraíble garantiza una limpieza fácil y eficiente.

Quatre broches assurent la stabilité. Le ressort amovible assure un nettoyage facile et efficace.



REF	W x D cm	
46787	11,5 x 15,7	12

P319 Cocktail spoon

Cuchara batidora
Cuillère à cocktail



REF	L cm	
P319000	26,5	300
P319100	28,0	360

P3181 Cocktail strainer

Colador gusanillo
Passoire à cocktail

Four prongs provide stability.
Removable spring ensures easy and efficient cleaning

Las cuatro puntas ofrecen estabilidad. El resorte extraíble garantiza una limpieza fácil y eficiente.

Quatre broches assurent la stabilité. Le ressort amovible assure un nettoyage facile et efficace.



REF	Ø cm	W x D cm	
P318100	7,6	11,7 x 15	144

P616 Lemon squeezer

Exprime limones
Presse citron



REF	Ø cm	
P616000	17	144

P399 Jigger

Dosificador licor
Mesure à cocktail



REF	Ø cm	H cm	ml	
P399000	A 3,7 B 4,1	A 2,8 B 5,7	25 50	200

16.2 Barmats

Alfombras para bar
Tapis de bar

P26100 Bar mat
Alfombra de bar para escurrido de copas
Tapis égouttoir pour verres



They can be connected with each other forming bigger surfaces
Se pueden conectar unas con otras formando mayores superficies
Avec système de liaison pour composer une surface plus grande

REF	W x D x H cm	
P26100	30 x 30 x 1,20	1

2331 Service mat
Alfombra bar rectangular
Tapis de service



Flexible thermoplastic rubber
Caucho termoplástico flexible
Caoutchouc thermoplastique flexible

REF	W x D x H cm	
2331-99	45,7 x 30,5 x 1,3	6

3616 Bar keep
Botella bar
Bouteille de bar



Includes:
1 neck + 1 jar + 1 lid + 6 assorted colored spouts.

El juego incluye:
1 cuello + 1 jarra + 1 tapa + 6 picos estándar de diversos colores.

Le kit comprend:
1 goulot + 1 récipient + 1 couvercle
+ assortiment de 6 becs verseurs standard en couleurs.

REF	Lts	cm	
3616	0,47	25,7 x 9,20	12
3632	0,95	34,0 x 9,50	12
3648	1,40	38,1 x 16,5	6
3664	1,90	34,90 x 12,7	6
3628	3,80	43,2 x 14,0	6

Condiment dispensers 16.2

Dispensador de condimentos
Distributeur de condiments

4741-06 Condiment Bar Dispenser. Black
Caja condimentos negra
Boîte à condiments



4741-06



4743-06

REF	W x D x H cm	Lts	Compart.	
4741-06	30,5 x 15,2 x 11,4	1,9	4	1
4743-06	45,7 x 15,2 x 15,6	2,8	6	1

- Not dishwasher safe.
- Transparent polycarbonate lid with automatic closure.
- The lid design increases the capacity and allows the item to be filled.
- Lids with holes allow utensils to be stored inside with the lid closed.
- Chiller plates are located on the bottom, keeping the condiments cool.

- No aptos para lavavajillas.
- Tapa policarbonato transparente con cierre automático.
- El diseño de la tapa aumenta la capacidad y permite llenar el artículo.
- Las tapas con orificios permiten mantener el utensilio dentro con la tapa cerrada.
- Las placas enfriadoras se colocan en la parte inferior, manteniendo los condimentos fríos.

- Pas adapté pour lave-vaisselle.
- Couvercle en polycarbonate transparent avec fermeture automatique.
- La conception du couvercle augmente la capacité et permet de remplir l'article.
- Les couvercles avec orifices permettent de garder l'ustensile à l'intérieur avec le couvercle fermé.
- Les plaques de refroidissement sont placées sur la partie inférieure, en conservant les condiments froids.

4747 Cooling plate for condiment holder
Placa enfriadora para caja condimentos
Plaque réfrigérante pour Boîte à condiments



REF	W x D x H cm	
4747	13,2 x 11,4 x 2,9	6

P3994 Condiment holder
Caja condimentos
Condiments



REF	W x D x H cm	L / Compart.	
P399400	30 x 14 x 8,5	0,45 x 4	12
P399500	38 x 14 x 8,5	0,45 x 5	12
P399600	45 x 14 x 8,5	0,45 x 6	12

16.2 Wine complements

Complementos de vino
Accessoires de vin

P985 Bottle stopper
Tapón botella
Bouchon bouteille



REF	Ø cm	H cm	
P985000	3	5,5	200

46622 Bottle coaster
Base para botellas
Sous-bouteille



NEW!

REF	Ø cm	
46622	15,6	24

46789 Waiter's corkscrew
Sacacorchos camarero
Tire-bouchon limonadier



NEW!

REF	L cm	
46789	11,7	12

P9845 Wall-mounted corkscrew
Sacacorchos de pared
Tire-bouchon mural



VOLLRATH

500

P983 Ring stop drop
Anillo anti-goteo
Stop gouttes



REF	Ø cm	H cm	
P983000	4	2	1

P984 Double-lever corkscrew
Sacacorchos doble palanca
Tire-bouchon double levier

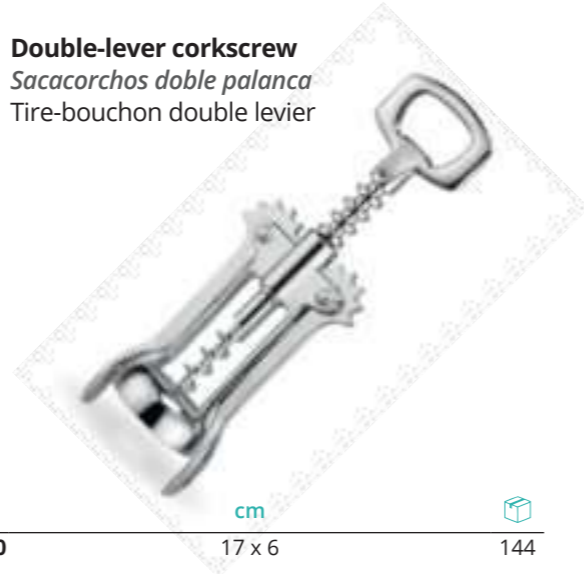

REF	cm	
P984100	17 x 6	144

47602 Pulltap's™ Kellnermesser corkscrew
Sacacorchos camarero Pulltap's™
Tire-bouchon de serveur Pulltap's™



PATENTED

Double lever
Palanca doble
Double levier

Five turn Teflon® coated forged steel. Internal cutting blade.
Acero forjado revestido de Teflon®. Hoja de corte interior.
Acier forgé revêtu de Teflon® cinq tours. Lame coupante intérieure.

REF	Spirale / Espiral cm	L cm	
47602	5,1	11,7	10

REF	W x D x H cm	
P984500	8 x 26 x 32	6

pujadas

Trays 16.2

Bandejas
Plateaux

P619 St/Steel round serving tray
Bandeja camarero en acero inox
Plateau limonadier en acier inox



Mirror finished
Pulido brillante
Polissage brillant



REF	Ø cm	
P619002	35	1
P619000	40	1

P956 Non slip serving tray
Bandeja camarero antideslizante
Plateau de service antidérapant



Black and brown colour
Color Negro i marrón
Couleur noir et marron



REF	Ø cm	
P956035	35	12
P956040	40	12
P956135	35	12
P956140	40	12

VOLLRATH

501

1474 Non-Skid Trays
Bandeja camarero antideslizante
Plateau de service antidérapant

Non-slip
Antideslizante
Antidérapant

Black
Negro
Noir



REF	Ø cm	
1474-0606	35,6	12
1476-0606	40,6	12

1612 Anti-Skid Mat Tray Accessories
Mantel antideslizante
Tapis antidérapant



REF	cm	
1612-06	41 x 31,8	12
1420-01	Ø 31,8	12

NEW

pujadas



P8920B White creamer
Lechera blanca
Crémière blanche



REF	Lts	
P892015B	0,15	1
P892035B	0,35	1
P892060B	0,60	1

P8920N Black creamer
Lechera negra
Crémière noire



REF	Lts	
P892015N	0,15	1
P892035N	0,35	1
P892060N	0,60	1

P8920R Red creamer
Lechera roja
Crémière rouge



REF	Lts	
P892015R	0,15	1
P892035R	0,35	1
P892060R	0,60	1



P890 Tea pot with filter
Tetera con filtro
Théière avec filtre



REF	Lts	
P890025	0,25	72
P890035	0,35	36
P890060	0,60	36

P891 Coffee pot with filter
Cafetera con filtro
Cafetière avec filtre



REF	Lts	
P891035	0,35	36
P891060	0,60	36
P891100	1,00	36

P892 Creamer
Lechera
Crémière



REF	Lts	
P892015	0,15	72
P892025	0,25	72
P892035	0,35	36
P892060	0,60	36
P892100	1,00	36
P892150	1,50	24
P892200	2,00	24

P893 Sugar bowl with lid
Azucarero con tapa
Sucrier avec couvercle



REF	Lts	
P893025	0,25	72
P893035	0,35	72

16.3 Cosmos

P885 Tea pot with filter
Tetera con filtro
Théière avec filtre



REF	Lts	
P885025	0,25	108
P885040	0,40	36
P885060	0,60	36

P886 Coffee pot with filter
Cafetera con filtro
Cafetière avec filtre



REF	Lts	
P886035	0,35	36

P887 Creamer
Lechera
Crémère



REF	Lts	
P887015*	0,15	72
P887025*	0,25	72
P887060	0,60	36
P887100	1,00	24

* Special handle design for refs. P887015 and P887025 for a better handling.
Diseño especial asas refs. P887015 y P887025 para facilitar el manejo.
Spécial design pour anses ref. P887015 et P887025 des améliorer la prise en main.

Atlantis

SS
Stainless
steel

P880 Tea pot with filter
Tetera con filtro
Théière avec filtre



REF	Lts	
P880035	0,35	50
P880050	0,50	50

P881 Coffee pot with filter
Cafetera con filtro
Cafetière avec filtre



REF	Lts	
P881100	1,00	1

P882 Creamer
Lechera
Crémère



REF	Lts	
P882015	0,15	50
P882035	0,35	50
P882100	1,00	50

Tea pots 16.3

Teteras
Théières



P23003 "Japan" tea pot
Tetera "Japón"
Théière "Japon"

CI
Cast
Iron



Cast iron.
Hierro fundido.
Fonte en fer.

Enameled inside.
Esmaltado interior.
Intérieur émaillé.



With St/Steel filter.
Con filtro de acero inoxidable.
Avec filtre en acier inoxydable.

REF	Filter / Filtro / Filtre Ø cm	Lts	
P23003	7,0	0,35	12
P23004	8,0	0,80	8

P23015 "Kenya" tea pot
Tetera "Kenya"
Théière "Kenya"

CI
Cast
Iron



Cast iron.
Hierro fundido.
Fonte en fer.

Enameled inside.
Esmaltado interior.
Intérieur émaillé.



With St/Steel filter.
Con filtro de acero inoxidable.
Avec filtre en acier inoxydable.

REF	Filter / Filtro / Filtre Ø cm	Lts	
P23015	7,0	0,30	12

P23008 "Nipon" tea pot
Tetera "Nipon"
Théière "Nipon"

CI
Cast
Iron



Cast iron.
Hierro fundido.
Fonte en fer.

Enameled inside.
Esmaltado interior.
Intérieur émaillé.



With St/Steel filter.
Con filtro de acero inoxidable.
Avec filtre en acier inoxydable.

REF	Filter / Filtro / Filtre Ø cm	Lts	
P23008	7,0	0,30	12
P23009	8,0	0,60	8

P896 Coffee maker - herbal tea jug
Jarra para infusiones
Pot à infusions

SS
Stainless
steel

Cr
Crystal



+100°C

To remove the glass it is
necessary to unscrew.
Para sacar el cristal es
necesario desatornillar.
Pour enlever le verre il est
nécessaire de dévisser.

REF	Lts	
P896003	0,35	30
P896008	0,80	24

16.4 Servers

Servidores
Verseuses



Servers 16.4

Servidores
Verseuses

P894 Airpot thermo inox with feeder
Termo con dosificador
Verseuse à pompe



Rotative base.
Base rotativa.
Fond rotatif.

Inner side in St/Steel
Interior en acero inoxidable
Intérieur en acier inoxydable

REF	Lts	
P894003	3,00	6
P894004	4,00	6
P894005	5,00	6

P896 Airpot thermo inox with feeder
Termo inox con dosificador
Verseuse à pompe thermo inox



Rotative base.
Base rotativa.
Fond rotatif.

Inner side in St/Steel
Interior en acero inoxidable
Intérieur en acier inoxydable

REF	Lts	
P896001	1,9	1
P896002	3,0	1

P337 Luxe insulated coffee pot
Jarra termo luxe
Pichet isolant luxe

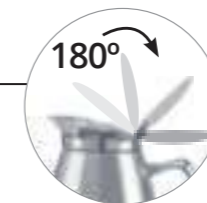

Inner side in St/Steel
Interior en acero inoxidable
Intérieur en acier inoxydable

IDEA! Ideal for dishwasher.
Ideal para lavavajillas.
Ideal pour lave-vaisselle.

REF	Lts	
P337030	0,30	12
P337060	0,60	12
P337090	0,90	12
P337150	1,50	12
P337200	2,00	12

P895 Vacuum jug
Servidor termo
Verseuse thermo



Inner side in St/Steel
Interior en acero inoxidable
Intérieur en acier inoxydable



REF	Lts	
P895006	0,60	6
P895010	1,00	6
P895015	1,50	6
P895020	2,00	6

P898 Thermo jug
Jarra termo
Pichet isotherme



dishwasher



Inner side in glass
Interior en vidrio
Intérieur en veurre

REF	Colour / Color	Lts	
P898001		1	1
P898002		1	1

52172 Hot-N-Cold **SWIRLSERVE®**
Servidor termo Hot-N-Cold
Pichet isotherme Hot-N-Cold



dishwasher

microwave



Looks like porcelain
Aspecto cerámico
Ressemble à la
porcelaine



With orange, brown, and white tabs allow easy differentiation.
Con pestañas de color naranja, marrón o blanca que permiten
diferenciar fácilmente.
Avec pousoirs orange, marron ou blanc pour une meilleure
différenciation.

REF	Colour / Color	Lts	
52172		0,60	12
52162		0,60	12
52170		1,25	12
52160		1,25	12
52174		1,90	6
52164		1,90	6

16.4 Pitchers

Jarras
Pichets



Pitchers

Jarras
Pichets

46599 Server without lid
Jarra bombada con retén
Pichet bombé avec retenu



REF	Lts	
46599	1,8	1

P335 Server without lid
Jarra bombada con retén
Pichet bombé avec retenu



REF	Lts	
P335002	1,8	20

Pitchers 16.4

Jarras
Pichets

P6464 Server
Jarra
Pichet



Tube for ice
Tubo para hielo
Tube pour les glaçons



Ideal for juices.
Ideal para zumos.
Idéal pour des jus.

REF	Lts	
P646400	1,9	6

P6442 Server
Jarra
Pichet

EXCLUSIVE



Made of SAN.
Fabricada en SAN.
Fabriquée en SAN.

+80°C



REF	Lts	
P644200	1,00	12
P644240	1,40	12
P644275	1,75	12

P6463 Polypropylene lid for stackable Server
Tapa polipropileno para jarra apilable
Couvercle polypropylène pour pichet empilable



REF	Color / Colour	Lts	
P646300	Blue	1	24
P646310	Grey	1	24
P646301	Blue	2	12

P649 Carafe tritan
Jarra agua tritan
Carafe en tritan



EXCLUSIVE



REF	Lts	
P649050	0,50	1
P649100	1,00	1

P646 Stackable polycarbonate server without lid
Jarra policarbonato apilable sin tapa
Pichet polycarbonate empilable sans couvercle



REF	Color / Colour	Lts	
P646100	White	1	24
P646103	Blue	1	24
P646105	Green	1	24
P646200	White	2	24

Fits only on the stackable polycarbonate servers P646.
Sólo para jarra policarbonato apilable sin tapa P646.
Adaptables uniquement sur les pichets polycarbonate empilables P646.

16.5 Lidsavers and cupdispensers

Dispensadores de tapas y vasos
Distributeur de couvercles et gobelets



LIDSAVER™ 3

SANITARY SOLUTIONS

- Sanitary dispensing system helps eliminate contamination from excess handling.
- Keeps operations clean and tidy, addressing major consumer concerns about health and well-being.

SOLUCIONES HIGIÉNICAS

- El sistema de dispensado higiénico previene la contaminación por manipulación excesiva.
- Mantiene las operaciones limpias y ordenadas y responde a las inquietudes de los consumidores en cuanto a salud y bienestar.

SOLUTIONS HYGIÉNIQUES

- Ce système de distribution hygiénique empêche la contamination causée par une manipulation excessive.
- Maintient les locaux propres et ordonnés, répondant ainsi aux principaux soucis des clients en ce qui concerne la santé et le bien-être.

CUSTOMER BENEFITS

- A welcome environment that is clean and tidy.
- Noticeably more hygienic service fosters customer goodwill.
- Simple-to-use design allows customers to fill beverages and put on a lid using only one hand.

BENEFICIOS PARA LOS CLIENTES

- Un ambiente agradable, limpio y ordenado.
- Un servicio notablemente más higiénico fomenta la buena voluntad de los clientes.
- El diseño fácil de usar permite a los clientes llenar bebidas y poner la tapa usando una sola mano.

AVANTAGES POUR LE CLIENT

- Un cadre accueillant, propre et ordonné.
- Un service de toute évidence plus hygiénique dope les ventes.
- Utilisation simple et facile qui permet aux clients de remplir leur gobelet de boisson et de mettre le couvercle d'une seule main.

COST SAVINGS

- Fewer wasted lids adds up to more savings.
- Counters are kept free of stacks of new lids and messy rejected lids, requiring less labor for cleanup.

AHORROS

- Menos pérdidas de tapas significan más ahorro.
- Los mostradores se mantienen libres de pilas de tapas nuevas y tapas rechazadas, desordenadas, lo cual se traduce en menos trabajo de limpieza.

ÉCONOMIES

- Moins de couvercles gaspillés, ce qui se traduit par plus d'économies.
- Les comptoirs ne sont pas encombrés par des piles de couvercles neufs et des couvercles usagés et sales, ce qui demande moins de main-d'oeuvre pour le nettoyage.

UP TO 30% COST SAVINGS

AHORRAR HASTA UN 30% DE LOS COSTES
ÉCONOMISEUR DE 30% DES COÛTS



VOLLRATH

510

pujadas

Lidsavers and cupdispensers 16.5

Dispensadores de tapas y vasos
Distributeur de couvercles et gobelets



Lidsaver™ 3

Assembly Montaje Montage

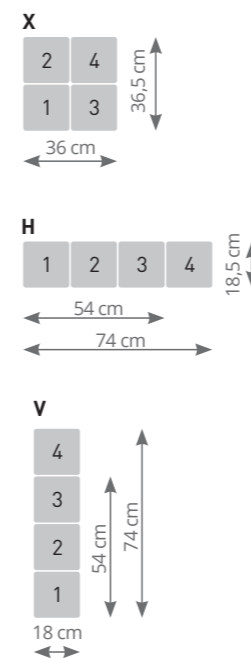

T1 (L)

Lids / Tapas / Couvercles
LS03 K / LS03 M

Model / Modelo	Code / Código
Berry™ DLT1310 Domed	AB
Berry™ DLT1310SS	AC
Berry™ DLT1402 Domed	AD
Berry™ DLT1402SS	AE
Berry™ DLT1408 Domed	AF
Berry™ DLT1408SS	AG
Dart® 16EL	AJ
Dart® 16LCDH	AK
Dart® 16RCL	AL
Dart® 16SL	AM
Dart® 20SL	AN
Dart® 20SLR	AO
Dart® 32SL	AP
Dart® 32SLR	AQ
Dixie® 9542	AR
Dixie® 955	JY
Dixie® TP9542	AS
Dixie® TP9550	JZ
International Paper LCRS 32	AT
International Paper LCTS 44	AU
Sweetheart® LGX12R	AY
Solo® 626	AZ
Solo® DL626	BB
Solo® DLR642	BC
Solo® LD16A	BD

T2 (C)

Cup dispenser
Dispensador vaso
Distributeur de gobelets

REF	Code / Código	Type / Tipo
INC-80	A	Plastic / Plástico Plastique
CADJ-3	D	St/Steel / Inox

T3 (S)

Straw dispenser
Dispensador de pajitas
Distributeur de pailles

REF	Code / Código
S1	S

T4 (P)

Condiment pocket
Apartado para condimentos
Casier à condiments

REF	Code / Código
P1	P

For other lid models, consult your dealer.
Para otros modelos de tapa, consultar a su comercial.
Pour d'autres modèles de couvercles, consulter votre agent.

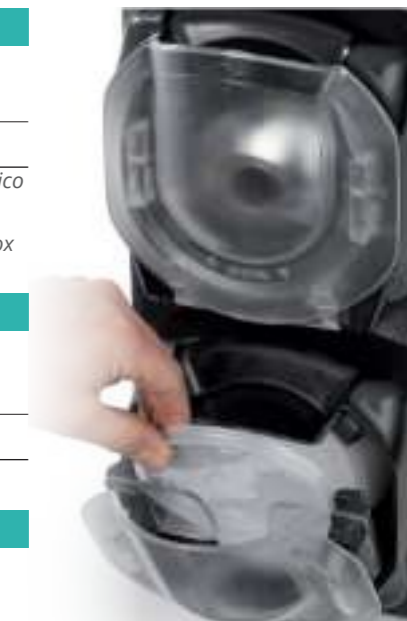

LS03 K Lids and cups dispenser display Mueble dispensador tapas y vasos Meuble distributeur couvercles et gobelets

REF + TYPE + CODE K4V-LLCC-AB-AD-A-A



REF	Tipo / Type	Code / Código
K1	L	T1
K2H	LL	T1 + T1
K2V	LC	T1 + T2
	LP	T1 + T4
	LLL	T1 + T1 + T1
K3H	LCC	T1 + T2 + T2
K3V	LCS	T1 + T2 + T3
	LCP	T1 + T2 + T4
	LCCC	T1 + T2 + T2 + T2
K4H	LCCS	T1 + T2 + T2 + T3
K4V	LCCP	T1 + T2 + T2 + T4
	LLCC	T1 + T1 + T2 + T2
	LCCC	T1 + T2 + T2 + T2
K4X	LCCS	T1 + T2 + T2 + T3
	LCCP	T1 + T2 + T2 + T4
	LLCC	T1 + T1 + T2 + T2

VOLLRATH

511

LS03 M Vertical lids dispenser display Mueble dispensador tapas vertical Meuble distributeur couvercles vertical

REF + CODE M2V-LL-AB-AE



REF	Code / Código	H cm
M1-L	+T1	18,5
M2V-LL	+T1 + T1	36,5
M3V-LLL	+T1 + T1 + T1	54,0
M4V-4L	+T1 + T1 + T1 + T1	74,0

pujadas

16.5 Lidsavers and cupdispensers

Dispensadores de tapas y vasos
Distributeur de couvercles et gobelets

KDS Lids and cups dispenser organizer display
Mueble dispensador tapas y vasos con organizador
Meuble distributeur couvercles et gobelets avec organisateur



REF	Code / Código	H cm	📦
K1LLDS	T1	42,5	1
K2VLCLDS	T1 + T2	60,5	1
K2VLLDS	T1 + T1	60,5	1
K3VLLCLDS	T1 + T2 + T2	78,5	1

Lidsaver™ 3 MINI

T5 (L)

Lids / Tapas / Couvercles
LS03 J / LS03 M

Type / Tipo	Code Código
Dart® Solo® P150	M9
Dart®/Solo® PL2	N1
Natureworks Inego PLA 3.085/310	YQ
International Paper LCM-12S	D9
International Paper LCWS12	XE
International Paper LCRS 12	EQ
International Paper LHSL-8	XK
Pactiv YLP10C	ZD
Solo® L10BL	ST
Solo® PL4	ZN
Solo® TL3-8	IT
Solo®TLRN38	ZM
Sweetheart® DLX8R	GV
SUP-10D	YT
Quick 6 Oz. BIS-H	YH
WinCup® 6L STYROLID	VG

For other lid models, consult your dealer.
Para otros modelos de tapa, consultar a su comercial.
Pour d'autres modèles de couvercles, consulter votre agent.

LS03 Lids In-counter dispenser
Dispensador encastrable tapas
Distributeur encastrable couvercles

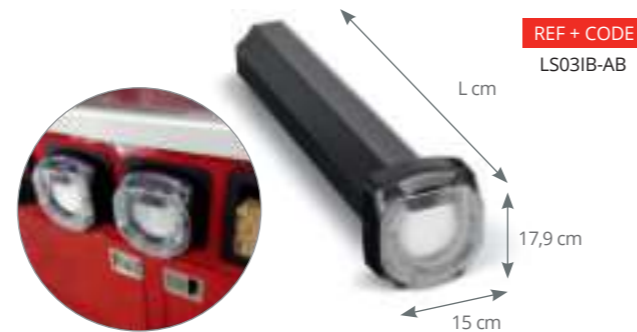

REF	Code Código	Posicions Posiciones	L cm	For / Para / Pour cm	📦
LS03IB	T1	H	58,5	8,3 - 9,5	1
LS03IVB	T1	V	58,5	8,3 - 9,5	1
LS03PB	T1	H	58,5	9,7 - 12,1	1
LS03PVB	T1	V	58,5	9,7 - 12,1	1
LS03IS18B	T1	H	45,5	8,3 - 9,5	1
LS03PS18B	T1	H	45,5	9,7 - 12,1	1

LS03 J Mini lid dispenser display
Mueble dispensador mini tapas
Meuble distributeur mini couvercles



REF	Type / Tipo	Code / Código	B x H cm
J1	L	T5	13,5 x 19,1
J2V	LL	T5 + T5	13,5 x 36,0
J2H	LL	T5 + T5	28,5 x 19,1
J3V	LLL	T5 + T5 + T5	13,5 x 52,5

LS03 M Mini lid In-counter dispenser
Dispensador encastrable mini tapas
Distributeur encastrable mini couvercles



REF	Code / Código	Posicions Posiciones	L cm	📦
LS03MS18B	T5	H	45,5	1
LS03MVS18B	T5	V	45,5	1

For / Para / Pour : 4,4 - 8,3 cm

Lidsavers and cupdispensers 16.5

Dispensadores de tapas y vasos
Distributeur de couvercles et gobelets

RSCL Lids and cups dispenser
Dispensador vasos y tapas
Distributeur gobelets et couvercles



REF	L cm	Ø cm	For / Para / Pour cm	📦
RSCL-4	38	101,5	-	1
LD2-2	11	65,0	10,5	1
LD3-2	13	65,0	12,4	1
PLC-1	8	65,5	5,7 - 7,3	1
PLC-2	9,5	65,5	7,3 - 8,9	1
PLC-3	11	65,5	8,9 - 10,5	1

INC / CADJ Cup dispenser
Dispensador vaso
Distributeur de gobelets



REF	L cm	Ø cm	For / Para / Pour cm	📦
INC-80	58,5	13,5	5,7 - 12,1	1
INC-80S18	46,0	13,5	5,7 - 12,1	1
CADJ-1	56,0	13,5	6,4 - 8,9	1
CADJ-2	56,0	14,5	7,6 - 9,8	1
CADJ-3	56,0	17,5	7,6 - 11,7	1

3825 Straw dispenser
Dispensador de pajitas
Distributeur de pailles



REF	W x D x H cm	📦
3805-06	31 x 36,7 x 17,8	1
3820-28	32 x 14 x 18	1

NEW!

16.5 Lidsavers and cupdispensers

Dispensadores de tapas y vasos
Distributeur de couvercles et gobelets

G58807 Countertop dispenser
Dispensador de mostrador
Distributeur de comptoir



4 adjustable cup dispenser
4 T-lid holder
1 straw holder
Dispensador ajustable de 4 tazas
Soporte para 4 tapas en T
1 portapajillas
4 distributeurs de gobelets réglables
4 porte-couvercle en T
1 porte-pailles

REF	W x D x H cm	
G58807	36,2 x 62,5 x 80,5	1

4830-06 Three-tier self-serve dispenser
Dispensador autoservicio de tres niveles
Distributeur libre-service à trois niveaux



REF	W x D x H cm	
4830-06	14,3 x 30 x 35	1

4842 Self-Serve dispenser system
Dispensador auto-servicio
Système distributeur libre-service



CTCL-4B Four-compartment countertop cup and lid organizer
Organizador de sobremesa de vasos y tapas con cuatro compartimentos
Présentoir de comptoir à quatre compartiments pour gobelets et couvercles



REF	W x D x H cm	
CTCL-4B	15,4 x 57,2 x 53,3	1

CTFWH-8B Eight compartment flatware organizer
Organizador de cubiertos de 8 compartimentos
Range-couverts à 8 compartiments



REF	W x D x H cm	
CTFWH-8B	25,6 x 46 x 43,7	1

IDEA! Ideal for flatware, tea, condiment packets, salt, pepper, and products with high-volume usage.
Ideal para cubiertos, te, condimentos, sal, pimienta y para todo tipo de productos de mucha rotación.
Idéal pour couverts, thé, condiments, sel, poivre et toute sorte de produits à usage intensif.

REF	Color / Colour	W x D x H cm	
4806-01	■	13 x 28,5 x 11	1 NEW
4806-06	■	13 x 28,5 x 11	1
4842-01	■	14,3 x 40,6 x 35,2	1 NEW

Lidsavers and cupdispensers 16.5

Dispensadores de tapas y vasos
Distributeur de couvercles et gobelets

CTNO Condiment dispensers
Dispensadores de condimentos
Distributeurs de condiments

*Adjustable compartments
Divisores ajustables
Compartiments réglables



REF	W x D x H cm	Capacity Capacidad Capacité	Napkin / Servilletas Serviettes cm	
CTNO-06*	24,5 x 49,0 x 38,5	100	12,5 x 16,5 11,5-12,5 x 16,5	1

LDS Condiment dispensers
Dispensador de condimentos
Distributeur de condiments



REF	W x D x H cm	
CFIFO-4	42,2 x 25,6 x 42	1 NEW
LDS-4CUP*	29,5 x 53,5 x 51,5	1
CTC-3X2V**	29 x 27 x 41,5	1
LDS-3	18,4 x 61 x 24,4	1 NEW

* For lids and cups
Para tapas y vasos
Pour couvercles et gobelets
Ø 12 cm

**Adjustable dividers
Divisores ajustables
Séparateurs réglables

Index

Índice
Index

english

ITEM	PAGE	ITEM	PAGE
ADAPTOR BAR	192, 195	CAST IRON MINIATURE	460-461
ADJUSTABLE DISH CADDY	261	CATERING BAGS	216, 217
AIR POT	506	CAYENNE®	312-313
ANGLED ADAPTOR PLATE	329	CAYENNE® WARMERS & RETHERMALIZERS	310-314
ANTIMICROBIAL	102, 103	CENTURY	58, 59
ANTI-SKID MAT TRAY ACCESSORIES	501	CEREAL DISPENSER	435
APPLE CORER	138	CHAFERS	428-431
ASHTRAY	383, 483	CHAFERS ACCESSORIES	429, 432, 434
BAIN MARIE	50, 313, 318, 433	CHAFERS, ECONOMY	431
BAKERY DISPLAY CASES	396, 397	CHAFERS, INTRIGUE®	429
BAR KEEP	498, 500	CHALKMARKERS	451
BAR KEEP®	498	CHAMPAGNE BUCKET	491, 492, 494, 495
BAR MATS	498	CHAMPAGNE STOPPER	500
BAR SCOOP	497	CHARCOAL OVEN	29-31
BARRIER	450	CHECK MINDER	124
BASE FOR BURNER	85	CHIMNEY	28
BASKET, BREAD	473-477	CHINESE COLANDER	116
BASKET, WIRE	390	CHIP BAGGER	111
BEVERAGE TROLLEY	489, 490	CHOCOLATE FOUNTAIN	318
BILL SPIKE	482	CLEAR GN LIDS	341, 397
BIRD NEST MOULD	100	CLEARING TROLLEY	245, 246
BLACK FIRST	80	CLIP TAGS228, 234, 235, 239, 240	
BLACK PRO	78-79	COCKTAIL SERVICE	496, 497
BLACK SERIES	60	COCKTAIL SPOON	497
BLACK STEEL SPANISH PAELLA PAN	84	COCKTAIL STRAINER	497
BLACKBOARDS	451	COFFE MAKER	505
BOILER	154	COFFE POT	502-505
BOWL	221, 334, 337-339, 344-346, 348, 353-354, 356, 359-360, 362-363, 365-370, 380, 395, 437	COLANDER	115-116
BOWLS, ANGLED BEEHIVE	437	COLANDER	117
BOWLS, DOUBLE WALL INSULATED SERVING	221, 437	COLOR COOKWARE	55
BPA FREE GASTRONORM PAN	204, 205	COMPLETE KITS OF SHELVING	268-277
BREATH GUARDS, MOBILE	394	CONDIMENT HOLDER	499
BREATH GUARDS, MOBILE ACRYLIC	394	CONFECTIONERY FUNNEL	162
BRONZE COOKWARE	400	CONICAL SAUCEPAN	46, 50, 59
BRUSH	159	CONTACT GRILL	301
BUCKET WITH BASE	146	COOL • LINE	55, 71
BUCKET-HOLDER STAND	495	COOLING PLATE	433
BUCKET-HOLDER STAND	493	CORKSCREW	500, 502
BUFFET CUBIC. BUFFET TROLLEY	425-427	COUNTER-TOP DISPENSER	258, 427
BUFFET CUBIC. CUBES & SHELVES	421	COUNTERTOP MIXERS	302
BUFFET CUBIC. DISPLAY CASE	419, 422, 423	COUSCUS SET	51
BUFFET DISPLAY	339, 340, 395	COVERS, PLASTIC PLATE	485
BUFFET FUEL	432	COVERS, PLATE	485
BUFFET STATION	317	CREAMER	502-504
BUFFET WINE COOLER. CUBIC	418	CRÊPE MAKER	294
BUTTER SPREADER	114	CUBE CUTTER	135
CAKE DIVIDER	160	CUBED-GLASS DISPLAY CASES	321
CAKE MOULD	163-165, 169, 182	CUP	221, 369
CAKE SERVER	114, 442, 444	CUTLERY BIN	223
CAKE STAND	161	CUTLERY DISPENSER FOR SERVING TROLLEY	246
CAN OPENER	138	CUTTING BOARD	140-142
CARAMEL CREAM MOULD	169	CUTTING BOARD TABLE	140-142
CARAMELIZER	160	CUTTING BOARD VIOLET	142
CARD HOLDER	484	DELIVERY BACKPACKS	218-219
CARRY-SKEWERS	35, 482	DICER & SLICER	129, 130
CASSEROLE	60	DISHES	221, 334-336, 338, 344-350, 353-357, 360-361, 368, 370
CASSEROLE BLACK SERIES	60	DISHES, COLORED	336, 357
		DISPENSER AND DISPOSABLE COVERS	250

Index

Índice
Index

english

ITEM	PAGE	ITEM	PAGE
DISPENSERS	162, 434, 435	GASTRONORM STAND	198, 223, 379, 417
DISPENSING SOLUTIONS	510-515	GASTRONORM VIOLET	208
DISPLAY CABINET	402	GLASS	221, 356, 457, 496
DISPLAY COOKWARE	408-411	GLOVES	149
DISPLAY SLATES	466-467	GN BAMBOO BOX	391
DISPLAY STANDS	386, 391-393	GN HERMETIC LID	33, 197
DISPLAY TRAY	335, 340, 341, 345, 351, 371, 380, 395, 420, 467	GN HERMETIC LID EASY OPEN	197
DISPLAYER MELAMINE BOWLS. CUBIC	421	GN PASTRY PAN	154
DOUBLE CUTTER	158, 166-168	GN TRANSPORT TROLLEY	250-252, 258
DOUBLE FAST-FOOD TRAY TROLLEY	256	GRANITE-SLATE DISPLAYER	373
DOUBLE WALL INSULATED COOLER	493	GRATER	120-121
DREGDERS	123	GRAVY BOAT	479
DROP-IN	289, 293	GRID GN	92
EGG RING119		GRID PASTRY	88
EGG SLICER	138	GRILL	79, 80
ELECTRIC HEATING UNIT FOR CHAFING DISH	432	GRILL	27-37
ELECTRIC SLICING MACHINE	303	GRILLBOX LID	28
ELEGANCE	355	GRIPPER	28, 95, 99, 111, 113-114, 144, 342, 442, 444, 465, 497
ENAMELLED GAS BURNIER	85	HEART RING MOULD	168
ENAMELLED STEEL MINATURES	458	HEATING LAMPS	315-317
ENAMELLED STEEL PAELLA PAN	84	HEATING PLATE	318
EPP BOX	213	HEMISPHERICALD MOULD	155
FAST-FOOD TURNER113		HEXAGON MOULD	168
FISH SCALER	124	HOOK	118
FISH TURNER	99, 113	HOT CUPBOARD	321
FLAP IDENTIFICATION	227	HOT TRAY WARMER	257, 321
FLAP-RACK®	227, 228	HOT-PLATE WITH HANDLES	79
FLARED SAUCE CUPS	479	ICE BUCKET	493
FLATWARE BASKET	237	ICE CREAM CONTAINERS	153
FOOD PAN155, 201, 318, 345, 349-350, 355, 365, 370, 409, 429, 438, 461		ICE CREAM CUP	153
		ICE CREAM SCOOP	152
		ICE-CREAM CHURN	326
FOOD-PROCESSORS302-303		ICE-CREAM PARLOUR	150-151, 322-327
FORK	101, 103, 441-443, 446	INDUCTION HOB'S	284-293
FRENCH FRY CUTTER	131	INFORMATION SIGN450	
FRENCH STYLE SAUCEPAN	49	INOX-PRO46-53	
FRUIT & VEGETABLE SLICER	133	INSTITUTIONS	220-223
FRY PAN "LYONNAISE"	83	INSULATED COFFE POT	507
FRY PAN ALUMINIUM	73-76	ISOTHERMAL TRAY	256
FRY PAN BLACK SERIES	78	JIGGER	497
FRY PAN BLINIS	76	JUICE DISPENSER	435
FRY PAN CAST ALUMINIUM	78-80	KITCHEN BOWL	155
FRY PAN COOL • LINE	71	KITCHEN TIMER ALARM	147
FRY PAN CRÊPE	79, 80	KITS. CUBIC	415-417
FRY PAN DEEP ENAMELLED WITH HANDLES	84	KNIFE	441, 443, 446
FRY PAN IDEA	72	KNIVE / WHEEL (SPARE PART)	138
FRY PAN MULTIMETAL	69	LADLE	98, 369, 441-445
FRY PAN PUJADAS	1921	LARGE TRAY HOLDER	482
FRY PAN ST/STEEL	70-72	LEMON SQUEEZER.	497
FRY PANS	62-83, 408	LID FOR BREAKFAST CUP	221
FRYER	295	LID FOR COOKWARE	33, 49, 399
FUNNEL	118, 162	LID GN	33, 197, 203, 205, 207-208
GASTRONORM CONTAINERS (MELAMINE)	374-378	LID INOX-PRO	49
GASTRONORM CONTAINERS (POLYCARBONATE)	202-203	LID RACKS	236
GASTRONORM CONTAINERS (POLYPROPYLENE)	206-207	LIDSAVER®	510-515
GASTRONORM ENAMELLED STEEL	399	LOBSTER CRACKER	449
GASTRONORM FOR DEFROST TROLLEY	254	MANDOLINES	139
GASTRONORM SANDWICH BOTTOM	189, 199, 401	MANUAL FOOD PROCESSORS	129-139
GASTRONORM ST/STEEL	194-197		

Index

Índice
Index

english

ITEM	PAGE	ITEM	PAGE
MARBLE OBLONG DISPLAY PLATE	373	PLACE MATS	478
MATS	149	PLASTIC CHAMPAGNE BUCKET	494-495
MEASURING CUP	145, 146	PLATE COVERS	485
MEASURING CUPS	145	PLATING TONGS	107
MEASURING JUG	146	POLINORM® LID	197, 203, 205, 207
MEASURING JUG	146	POLYCARBONATE TUBE	174
MEASURING SCOOP	144	POLYPROPYLENE BASKETS	474-477
MEASURING SPOON	144, 145	PORTION CONTROL DISPENSER	162
MEAT BEATER	119	POT-GRABBER	149
MEDITERRANEAN	356	PUJADAS 1921. ULTRALIGHT WEIGHT CAST IRON INDUCTION	81
MELAMINE FOR PRESENTATION	334-383	PVC RIBBON	168
MELAMINE MINIATURES	380-382	RACK (BIG TRAYS)	240
MELAMINE SLIM	376-377	RACK (CLOSED SYSTEM)	234, 235
MENU HOLDER	484	RACK (DISHES)	238-240
METAL WIRE BASKET	471	RACK (FLATWARE)	236, 237, 477
METALLIC BRUSH	124	RACK (ISOTHERMAL TRAYS)	240
MICRO-WAVES	294	RACK (OPENED SYSTEM)	230-233
MILK DISPENSER	434, 435	RACK (UNIVERSAL)	236
MINIATURE CAST ALUMINIUM	459	RAMEKIN	145, 337, 380, 463, 477, 479, 480
MIRAGE®	292-293, 306-309	RECTANGLE FOR BAKING SHEETS	90
MIRAGE® 3D INDUCTION	306-307	RETHEMALIZER RETRO	308-309
MIRAGE® INDUCTION WARMER	293	RETHEMALIZERS	306-313
MIRAMAR®	408-411	RICE COOKER	294
MIRAMAR® DISPLAY COOKWARE	406-409	RING	167
MIXERS	302, 303	RING STOP DROP	500
MIXING PADDLE	124	ROAST PAN	88
MOULDS "FLEXIPAN"	175-181	ROLLING PIN	158-159
MULTIMETAL	50, 77	SALAD BOWL	439
NAPKIN HOLDER	419, 483, 515	SALAD CUTTER	132
NAPKIN HOLDER. CUBIC	419	SALT MILL	481
NATURAL BAMBOO & WOOD	468, 469	SANITARY GEL LUBRICANT	139, 303
NON SLIP SERVING TRAY	482, 501	SAUCE PAN ALUMINIUM	59
NON-SMOKING SING	481	SAUCE PAN COOL • LINE	55
NON-STICK SILICONE MAT	95	SAUCE PAN INOX-PRO ST/STEEL	49-50
NUMBER CARD HOLDER	481	SAUCE POT ALUMINIUM	58
NUT CRACKER	449	SAUCE POT COOL • LINE	55
OIL POURER	124	SAUCE POT ST/STEEL INOX-PRO	48
ONION CUTTER	133	SAUTÉ PAN ALUMINIUM	59
OVAL MOULD	165, 168	SAUTÉ PAN INOX-PRO	50
OVAL SERVING DISH	345, 349-350, 355, 365, 370, 438, 461	SCALE	147
OVAL SERVING TRAY	482	SCOOP	152, 155, 497
OVEN MITT	149	SCRAPER	113-114
OVENS	29-31, 294	SERVER	507
PAELLA PAN ALUMINIUM	73	SERVER, POLYCARBONATE	509
PAELLA PAN INOX-PRO ST/STEEL	48	SERVING PADDLE	342, 465
PAN BAND	198	SERVING BOARD	342
PASTA COLANDER	52	SERVING TOOLS	440-449
PASTRY BAGS	170	SERVING TRAY	388, 389, 501
PASTRY MOULDS	163-165, 167-169, 177-189	SERVING TRAY. CUBIC	416-418, 420
PASTRY TORCH	160	SHAKER	496
PEPPER MILL	481	SHELVING	268-277
PERFORATED BOTTOMS GASTRONORM	195, 196, 203, 205, 254	SIEVES	161
PIZZA BAGS	214, 215	SILICONE MOULDS	182-185
PIZZA BAKING SHEETS	93	SILICONE MOULDS 600 X 400	184-185
PIZZA MOULD	93	SKEWER	28, 482
PIZZA PAN	93, 94	SKEWER SERVING SUPPORT. CUBIC	418
PIZZA PEEL	95	SKEWER SUPPORT. CUBIC	419
PIZZA WHEEL	113	SKIMMER	99, 100, 441-444

Index

Índice
Index

english

ITEM	PAGE	ITEM	PAGE
SNACK BOWL SET	344, 352, 360, 380, 382, 479	TROLLEY (ALUMINIUM SERVING)	245
SOUP KETTLE	314	TROLLEY (DEFROST WITH RAIL)	254
SOUP TOUREEN	439	TROLLEY (DISASSEMBLED SERVING TROLLEY)	248
SPATULA	99, 112, 113, 157, 441-446	TROLLEY (DISASSEMBLED WITH RAIL)	251-253
SPECIAL TROELLYS	257-261	TROLLEY (GUERIDON)	426
SPOODLE®	102-103, 105	TROLLEY (INOX SERVING)	246-249, 255
SPOON	100, 101, 103-105, 157, 369, 380, 441-446	TROLLEY (PLASTIC)	244, 245, 260, 261
SPOONS	441-443, 444-446	TROLLEY (RAIL)	250-257
SQUEEZE DISHER	104	TROLLEY (STACKABLE)	251, 252
SQUEEZE DISPENSER	122, 123	TROLLEY (WOODEN)	425-427
ST/STEEL SELF-SERVICE TRAY	222	TROLLEY FOR DISHWASER RACKS	259-260
STAINLESS STEEL MINIATURES	454-456	TROLLEY FOR HEAVY LOADS	259
STAINLESS STEEL PLATE COVERS	485	TROLLEY WITH WORKING TOP	258
STAND FOR CHINESE COLANDER OR FUNN	116	TUBE	171-174
STAND FOR CUTTING BOARDS	202	T-VERSION	228-233
STAND FOR GN CONTAINERS	198, 379	UNIVERSAL STOPPER	500
STAND FOR GN LIDS	202	VEGETABLE SCRAPER	140
STEAM POT INOX-PRO	52	VEGETABLE SIEVE	118
STOCK POT ALUMINIUM	56-59	VERSATIL MACHINE	135
STOCK POT COOL • LINE	52	VERSATILE MANUAL PROCESSOR	137
STOCK POT INOX-PRO	48, 44	VINYL RACK COVER	261
STOCK POT WITH TAP	52	VIOLET COLLECTION	208
STONE	354	WALL-MOUNTED COWKSCREW	502
SUGAR BOWL	503	WARMERS	313, 314
SUPER PAN® 3	201	WATER PITCHER	508-509
SUPER PAN® SUPER SHAPES	200-201	WEDGER	134
SUPPORT FOR CUTLERY DISPENSER	223, 237, 257, 420, 427	WHISK	156
SUPPORT FOR PASTRY BAGS	170	WHITE WOOD SERVING TRAY	371
TABLE CADDY	480	WINE BUCKETS	491, 492, 494, 495
TABLE CRUMBER	483	WINE COMPLEMENTS	500
TABLE NUMBER	481	WINE COOLER	495
TABLE SING "RESERVED"	481	WIRE SKIMMER	100
TABLE-TIDY	483	WOK (ST/STEEL)	72
TEA POT	503, 504-505	WOK BLAC SERIES	79
TEA POT WITH FILTER	504	WOK MULTIMETAL	77
TEA&SUGAR BAGS DISPENSER. CUBIC	419	WOK STEEL	83
TEAR MOULD	168	WOK STEEL PRO	81
TEMPLATES	41, 410-411	WOOD SERVING BOARDS	462
TERRACOTA	352-353	WOODEN BOX	387
THERMOMETER	147-148		
THREE LEVELS STAND. CUBIC	417		
TIN PLATES DISPLAY	464-465		
TOASTER	296-300		
TOMATOES SLICER	137		
TONG	35, 95, 107-110, 168, 446, 447-449, 469, 497		
TONG. BUTCHER'S	449		
TONG. CAKE	448		
TONG. UTILITY	108-109, 447		
TONGS, SERVING	447		
TRAY	89-92, 220, 222-223, 335, 340-341, 343-344, 350-355, 360, 362, 364-367, 371-372, 380, 382		
TRAY (FAST-FOOD)	222		
TRAY (GASTRONORM)	89, 367, 465		
TRAY (NON-STICK ALUMINIUM)	89, 91		
TRAY (PASTRY)	90-92, 351		
TRAYS, FIBERGLASS	222		
TRIANGLE CAKE MOULD	169		
TRIBUTE	45, 69		

Index

Índice
Index

español

ARTÍCULO	PÁGINA	ARTÍCULO	PÁGINA
ABRELATAS INDUSTRIAL	138	BUFFET CUBIC. MUEBLE EXPOSITOR	419, 422, 423
ALCUZA	124	CACEROLA ALUMINIO	58
ALFOMBRA DE BAR PAR ESCURRIR COPAS	498	CACEROLA COOL • LINE	55
ALFOMBRAS	149	CACEROLA INOX-PRO	48
ANILLO ANTI-GOTEO	500	CACILLO	98, 369, 441-445
ANTIMICROBIAL	102, 103	CADDY DE MESA	480
APLASTACARNES	119	CAFETERA502-505	
ARAÑA	100	CAJA CONDIMENTOS	499
ARMARIO CALIENTE	321	CAJA DE MADERA	387
ARO	167	CAJA GN BAMBU	391
ASADOR GRILL	79, 80	CAJA PPE	213
AZUCARERO	503	CALDERO	154
BALANZA	147	CALENTADOR DE PLATOS	257, 321
BAMBÚ NATURAL & MADERA	468, 469	CALENTADOR INDUCCIÓN MIRAGE	293
BANDA SELLADORA SILICONA	198	CALENTADORES	313, 314
BANDEJA	89-92, 220, 222-223, 335, 340-341, 343-344, 350-355, 360, 362, 364-367, 371-372, 380, 382	CARRO BEBIDAS	489, 490
BANDEJA ALUMINIO ANTIADHERENTE	89, 91	CARRO CON GUIAS	250-257
BANDEJA AUTO-SERVICE ACERO INOX	222	CARRO CON GUIAS, DESMONTABLE	251-253
BANDEJA FAST-FOOD	222	CARRO CON GUIAS, ENCASTRABLE	251, 252
BANDEJA GASTRONORM	89, 367, 465	CARRO CON SUPERFICIE DE TRABAJO	258
BANDEJA ISOTÉRMICA	256	CARRO DE MADERA	425-427
BANDEJA OVAL	482	CARRO DE PLÁSTICO	244, 245, 260, 261
BANDEJA PASTELERÍA	90-92, 351	CARRO DE SERVICIO DESMONTABLE	248
BANDEJA PORTACUBIERTOS	223	CARRO DE SERVICIO EN ALUMINIO	245
BANDEJA PRESENTACIÓN	...335, 340, 341, 345, 351, 371, 380, 395, 420, 467	CARRO DE SERVICIO INOXIDABLE	246-249, 255
BANDEJA SERVICIO	388, 389, 501	CARRO DESCONGELACIÓN	254
BANDEJAS ANTI-DESGLIZANTES	482, 501	CARRO DESEMBARACE	245, 246
BANDEJAS FIBRA DE VIDRIO	222	CARRO DOBLE PARA BANDEJAS FAST-FOOD	256
BANDEJAS PARA PIZZA	93	CARRO GASTRONORM DESCONGELACIÓN	254
BANDEJAS. CUBIC	416-418, 420	CARRO GUERIDON	426
BAÑO MARÍA	50, 313, 318, 433	CARRO PARA CARGAS PESADAS	259
BAR KEEP®	498	CARRO PARA CESTAS	259-260
BARRA DE NOTAS	124	CARRO PARA PLATOS AJUSTABLE	261
BASE PIZZA	93, 94	CARRO PORTA CUBETAS GASTRONORM	250-252, 258
BATERÍA BRONCE	400	CARRO PORTACUBIERTOS	258, 427
BATERIA COLOR	55	CARROS ESPECIALES	257-261
BATERÍA MIRAMAR®	406-409	CASCANUECES	449
BATERIA PRESENTACIÓN	408-411	CAYENNE®	312-313
BATIDOR	156	CAZO ALUMINIO	59
BATIDORA SOBRE MESA	302	CAZO BOMBEADO	46, 50, 59
BATIDORAS PLANETARIAS	302, 303	CAZO COOL • LINE	55
BLACK FIRST	80	CAZO INOX-PRO	49-50
BLACK PRO	78-79	CAZO TIPO FRANCÉS	49
BLACK SERIES	60	CAZOS DE MEDIDAS	145
BOL..221, 334, 337-339, 344-346, 348, 353-354, 356, 359-360, 362-363, 365-370, 380, 395, 437		CAZUELA ALUMINIO FUNDICIÓN	60
BOL DOBLE PARED	221, 437	CAZUELA BLACK SERIES	60
BOL ESTRIDADO INCLINADO	437	CEDAZO	161
BOLSAS DE CATERING	216, 217	CENICERO	383, 483
BOLSAS PARA PIZZAS	214, 215	CENTURY	58, 59
BOQUILLA	171-174	CEPILLO METÁLICO	124
BOQUILLA POLICARBONATO	174	CESTA GRANDES BANDEJAS	240
BOTELLA BAR	498, 500	CESTA METAL	471
BRASA	27-37	CESTA PAN	473-477
BUFFET CUBIC. CARRO BUFFET	425-427	CESTA PARA BANDEJAS ISOTÉRMICAS	240
BUFFET CUBIC. CUBOS Y ESTANTES	421	CESTA PARA CUBIERTOS	236, 237, 477
		CESTA REJADA	390
		CESTA UNIVERSAL	236
		CESTAS ABIERTAS	230-233

VOLLRATH

520

pujadas

Index

Índice
Index

español

ARTÍCULO	PÁGINA	ARTÍCULO	PÁGINA
CESTAS CERRADAS	234, 235	DOSIFICADOR LICOR	497
CESTAS PARA PLATOS	238-240	ELEGANCE	355
CESTAS POLIPROPILENO	474-477	ELEMENTO ELÉCTRICO CHAFING DISH	432
CESTILLO PARA CUBIERTOS	237	EMBUDO	118, 162
CHAFING , ACCESORIOS	429, 432, 434	EMBUDO DOSIFICADOR	162
CHAFING DISH	428-431	ENFRIADOR BOTELLAS BUFFET. CUBIC	418
CHAFING DISHEES ECONOMICOS	431	ENFRIADOR ISOTÉRMICO	493
CHAFING DISHES INTRIGUE	429	ENSALADERA ACRÍLICA	439
CHAMPAÑERA	491, 492, 494, 495	ESCAMADOR	124
CHAMPAÑERA, COMPLEMENTOS	500	ESCURRIDERA	117
CHIMENEA	28	ESPÁTULA	99, 112, 113, 157, 441-446
CINTA PVC PARA MOUSSE	168	ESPÁTULA PARA UNTAR	114
CLIP DE IDENTIFICACIÓN	228, 234, 235, 239, 240	ESPECIEROS	123
COCTEL	496, 497	ESPUMADERA	99, 100, 441-444
COCTELERA	496	ESTACION BUFFET TRINCHANTE	317
COLADOR115-116		ESTANTERÍAS	268-277
COLADOR CHINO	116	EXPOSITOR BOLLERIA	396, 397
COLADOR GUSANILLO	497	EXPOSITOR BUFFET	339, 340, 395
COLAPASTAS	52	EXPOSITOR DE TARTAS	161
COLECTIVIDADES	220-223	EXPOSITOR GASTRONORM	198, 223, 379, 417
CONJUNTOS COMPLETOS DE ESTANTERIAS	268-277	EXPOSITOR TRES NIVELES. CUBIC	417
CONJUNTOS. CUBIC	415-417	EXPOSITORES	386, 391-393
COOL • LINE	55, 71	EXPRIME LIMONES	497
COPA HELADO	153	FLANERO	169
CORTADOR / DESCORAZONADOR MANZANAS	138	FLAP IDENTIFICACIÓN	227
CORTADOR DE CEBOLLAS	133	FLAP-RACK®	227, 228
CORTADOR DE LECHUGA	132	FONDOS PERFORADOS GASTRONORM	195, 196, 203, 205, 254
CORTADOR DE PATATAS FRITAS	131	FREIDORA295	
CORTADOR EN CUBOS	135	FUEL PARA CHAFING DISH	432
CORTADOR SECCIONADOR	134	FUENTE. 155, 201, 318, 345, 349-350, 355, 365, 370, 409, 429, 438, 461	
CORTADOR TOMATES	137	FUENTE FONDUE CHOCOLATE318	
CORTADORA ELÉCTRICA DE FIAMBRES	303	FUENTE HONDA CÓNICA	155
CORTADOR-REBANADOR	129, 130	FUENTE OVAL	345, 349-350, 355, 365, 370, 438, 461
CORTAHUEVOS	138	FUNDA PROTECTORA DE VINILO	261
CORTAPASTAS	158, 166-168	GANCHO	118
CRÉPERA	294	GASTRONORM ACERO ESMALTADO	399
CUBERTERO PARA CARRO SERVICIO	246	GASTRONORM FONDO DIFUSOR	189, 199, 401
CUBETA GASTRONORM SIN BPA	204, 205	GASTRONORM INOXIDABLE	194-197
CUBETAS HELADERÍA	153	GASTRONORM MELAMINA	374-378
CUBITERA DE PLÁSTICO	494-495	GASTRONORM POLICARBONATO	202-203
CUBO CHAMPÁN	491, 492, 494, 495	GASTRONORM POLIPROPILENO	206-207
CUBO CON BASE	146	GASTRONORM VIOLET	208
CUBO HIELO	493	GEL LUBRICANTE SANITARIO	139, 303
CUCHARA	100, 101, 103-105, 157, 369, 380, 441-446	GN PASTRY PAN	154
CUCHARA BATIDORA	497	GRILL DE CONTACTO	301
CUCHARA MEDIDORA	144, 145	GUANTES PROTECCIÓN	149
CUCHARA SERVICIO	441-443, 444-446	HELADERÍA	150-151, 322-327
CUCHILLA/RODILLO DE RECAMBIO	138	HERVIDOR DE ARROZ	294
CUCHILLO	441, 443, 446	HORNOS	29-31, 294
CUSCUSERA	51	HORNOS DE BRASA	29-31
DISPENSADOR A PRESIÓN	122, 123	INDUCCIÓN 3-D MIRAGE	306-307
DISPENSADOR BOLSAS TE Y AZÚCAR. CUBIC	419	INOX-PRO46-53	
DISPENSADOR CON CONTROL DE PORCIONES	162	INSERTOS289, 293	
DISPENSADOR DE CEREALES	435	JARRA	507
DISPENSADOR DE ZUMOS	435	JARRA AGUA	508-509
DISPENSADOR LECHE	434, 435	JARRA DE MEDIDAS	146
DISPENSADOR Y FUNDAS DESECHABLES	250	JARRA MEDIDORA	146
DISPENSADORES	162, 434, 435	JARRA PARA INFUSIONES	505

VOLLRATH

521

pujadas

Index

Índice

Index

ARTÍCULO	PÁGINA	ARTÍCULO	PÁGINA
JARRA POLICARBONATO	509	PALA	28, 95, 99, 111, 113-114, 144, 342, 442, 444, 465, 497
JARRA TERMO	507	PALA CHIPS	111
LÁMPARAS MANTENEDORAS	315-317	PALA FAST-FOOD	113
LECHERA	502-504	PALA HIELO	497
LIBRADOR	152, 155, 497	PALA MEDIDORA	144
LIDSAVER®	510-515	PALA PASTELES	114, 442, 444
LLAUNAS PRESENTACIÓN	464-465	PALA PESCADO	99, 113
MANDOLINAS	139	PALA PIZZA	95
MANGAS PASTELERAS	170	PALA PRESENTACIÓN	342, 465
MANOPLA	149	PANEL INFORMACIÓN	450
MANTA ENFRIADORA	495	PAÑO SILICONA	149
MANTECADORA	326	PAPELERA SOBREMESA	483
MANTEL ANTIDESLIZANTE PARA BANDEJA	501	PARRILLA PLANA CON ASAS ALUMINIO	79
MANTELES INDIVIDUALES	478	PASAPURÉS	118
MARCADOR DE TARTAS	160	PERFILES DIVISORIOS	192, 195
MARCADORES TIZA	451	PIE CON PORTACUBOS	493
MARCOS PARA BANDEJAS	90	PINCEL	159
MEDITERRANEAN	356	PINCHANOTAS	482
MELAMINA PRESENTACIÓN	334-383	PINCHO / BROCHETA	28, 482
MELAMINA SLIM	376-377	PINCHOS. SOPORTE PRESENTACIÓN. CUBIC	418
MESA DE CORTE	140-142	PINZA	35, 95, 107-110, 168, 446, 447-449, 469, 497
MICRO-ONDAS	294	PINZA BUFFET	108-109, 447
MINIATURAS ACERO ESMALTADO	458	PINZA CHARCUTERÍA	449
MINIATURAS ALUMINIO FUNDICIÓN	459	PINZA PARA MARISCO	449
MINIATURAS HIERRO FUNDIDO	460-461	PINZA REPOSTERÍA	448
MINIATURAS INOXIDABLE	454-456	PINZA SERVICIO	447
MINIATURAS MELAMINA	380-382	PINZAS PARA EMPLATAR	107
MIRAGE®	292-293, 306-309	PIZARRAS	451
MIRAMAR®	408-411	PIZARRAS PRESENTACIÓN	466-467
MOCHILA DE REPARTO	218-219	PLACA “RESERVADO”	481
MOLDE CAKE	163-165, 169, 182	PLACA ADAPTADORA ANGULAR	329
MOLDE FORMA CORAZÓN	168	PLACA CALIENTE	318
MOLDE FORMA LÁGRIMA	168	PLACA ENFRIADORA	433
MOLDE HEXAGONAL	168	PLACA PROHIBIDO FUMAR	481
MOLDE HUEVO	119	PLACAS INDUCCIÓN	284-293
MOLDE MEDIA CAÑA	169	PLANTILLAS	41, 410-411
MOLDE NIDO	100	PLATOS	221, 334-336, 338, 344-350, 353-357, 360-361, 368, 370
MOLDE OVAL	165, 168	PLATOS COLORES	336, 357
MOLDE PARA PIZZA	93	PORCIONADOR APRETABLE	104
MOLDE SEMIESFÉRICO	155	PORTA CUBIERTOS	223, 237, 257, 420, 427
MOLDES “FLEXIPAN”	175-181	PORTA PINCHOS	35, 482
MOLDES DE SILICONA	182-185	PORTAMENÚS	484
MOLDES PASTELERÍA	163-165, 167-169, 177-189	PORTASALADOS / PORTASALSAS	344, 352, 360, 380, 382, 479
MOLDES SILICONA 600 X 400	184-185	PORTATARJETAS	484
MOLINILLO PIMIENTA	481	POSTE SEPARACIÓN	450
MOLINILLO SAL	481	PRESENTADOR BOLS MELAMINA. CUBIC	421
MULTIMETAL	50, 77	PRESENTADOR CUBETAS GN	198, 379
NÚMERO MESA	481	PROCESADOR DE ALIMENTOS	302-303
OLLA ALUMINIO	56-59	PROCESADOR VERSÁTIL MANUAL	137
OLLA CON GRIFO	52	PROCESADORES MANUALES DE ALIMENTOS	129-139
OLLA COOL • LINE	52	PROTECTOR ACRÍLICO ANTI-ALIENTO	394
OLLA ELÉCTRICA	314	PROTECTOR ANTI-ALIENTO	394
OLLA INOX-PRO	48, 44	PUJADAS 1921. HIERRO DE FUNDICIÓN ULTRALIGERO INDUCCIÓN	81
PAELLERA ACERO ESMALTADO	84	QUEMADOR ELÉCTRICO	160
PAELLERA ALUMINIO	73	RACIONADOR DE HELADO	152
PAELLERA INOX-PRO	48	RALLADOR	120-121
PAELLERA VALENCIANA	84	RASQUETA	113-114
PAELLERO ESMALTADO GAS	85	REBANADORA DE FRUTAS Y VERDURAS	133

español

español

ARTÍCULO	PÁGINA	ARTÍCULO	PÁGINA
RECIPIENTE PARA SALSAS	145, 337, 380, 463, 477, 479, 480	TAPA GRILLBOX	28
RECOGEMIGAS	483	TAPA HERMÉTICA GN	33, 197
RECOGEVERDURAS	140	TAPA HERMÉTICA GN EASY OPEN	197
REJILLAS GN	92	TAPA INOX PARA PLATOS	485
REJILLAS PASTELERÍA	88	TAPA INOX-PRO	49
RELOJ DE COCINA DIGITAL	147	TAPA PARA CESTA	236
REMO	124	TAPA PLATOS	485
RETERMALIZADOR	306-313	TAPA PLATOS PLÁSTICO	485
RETERMALIZADOR RETRO	308-309	TAPA POLINORM®	197, 203, 205, 207
RETERMALIZADORES / CALENTADORES ALIMENTOS	310-314	TAPA TAZA DESAYUNO	221
RODILLO	158-159	TAPAS GN TRANSPARENTES	341, 397
RULETA CORTAPIZZAS	113	TAPAS PARA PLATOS	485
RUSTIDERA	88	TAPETE DE SILICONA	95
SACACORCHOS	500, 502	TAPÓN CHAMPÁN	500
SACACORCHOS DE PARED	502	TAPÓN UNIVERSAL	500
SALSERA	479	TAZA	221, 369
SALSERA BORDE ONDULADO	479	TAZA MEDIDORA	145, 146
SARTÉN “LIONESA”	83	TENEDOR	101, 103, 441-443, 446
SARTÉN ACERO INOXIDABLE	70-72	TERMO CON DOSIFICADOR	506
SARTÉN ALUMINIO	73-76	TERMÓMETRO	147-148
SARTÉN ALUMINIO FUNDICIÓN	78-80	TERRACOTA	352-353
SARTÉN BLACK PRO	78	TETERA	503, 504-505
SARTÉN CRÊPES	79, 80	TETERA CON FILTRO	504
SARTÉN HONDA ESMALTADA CON ASAS	84	TOSTADORA	296-300
SARTÉN IDEA	72	TRIBUTE	45, 69
SARTÉN MULTIMETAL	69	TRÍPODE PAELLERO	85
SARTÉN PARA BLINIS	76	T-VERSION	228-233
SARTÉN STEEL PRO	81	UTENSILIOS DE SERVICIO	440-449
SARTENES	62-83, 408	VAPORERA INOX-PRO	52
SARTENES COOL • LINE	71	VASO	221, 356, 457, 496
SAUTEX ALUMINIO	59	VERSATIL MACHINE	135
SAUTEX INOX-PRO	50	VIOLET COLLECTION	208
SERVILLETERO	419, 483, 515	VITRINAS DE VIDREO	321
SERVILLETERO. CUBIC	419	VITRINAS PRESENTACIÓN	402
SOLUCIONES DE DISPENSADO	510-515	WOK ACERO	83
SOPERA	439	WOK BLACK SERIES	79
SOPLETE COCINA	160	WOK INOX	72
SOPORTE MÁRMOL EXHIBICIÓN	373	WOK MULTIMETAL	77
SOPORTE PARA BANDEJAS DE GRAN TAMAÑO	482	WOK STEEL PRO	81
SOPORTE PARA CHINO O EMBUDO	116		
SOPORTE PARA CUBO CHAMPÁN	495		
SOPORTE PARA MANGAS PASTELERAS	170		
SOPORTE PARA NÚMEROS	481		
SOPORTE PARA PINCHOS. CUBIC	419		
SOPORTE PARA TABLAS DE CORTE	202		
SOPORTE PRESENTACIÓN MADERA BLANCA	371		
SOPORTE PRESENTACIÓN PIZARRA-MÁRMOL	373		
SOPORTE TAPAS GN202			
SPOODLE®	102-103, 105		
STONE	354		
SUPER PAN® 3	201		
SUPER PAN® SUPER SHAPES	200-201		
TABLA DE CORTE	140-142		
TABLA DE CORTE VIOLET	142		
TABLA PRESENTACIÓN	342		
TABLAS DE MADERA	462		
TAPA BATERIA	33, 49, 399		
TAPA GN	33, 197, 203, 205, 207-208		

Index

Índice

Index

Index

Índice

Index

français

ARTICLE	PAGE	ARTICLE	PAGE
ANTIMICROBIEN	102, 103	CASSEROLES DOSEUR	145
APLATISSEUR	119	CAYENNE®	312-313
APPAREILS ET DE MAINTIEN EN TEMP.	313, 314	CAYENNE® RÉCHAUDS ET APPAREILS DE REMISE EN TEMPÉRATURE ..	310-314
APPAREILS MANUELS DE TRANSFORMATION DES ALIMENTS .129-139		CENDRIER	383, 483
ARAIGNÉE	100	CENTURY	58, 59
ARDOISES PRÉSENTATION	466-467	CERCLE	167
ARMOIRE CHAUD	321	CHAFERS	428-431
ASSIETTES	221, 334-336, 338, 344-350, 353-357, 360-361, 368, 370	CHAFERS INTRIGUE	429
ASSIETTES, COULEUR	336, 357	CHAFERS, ACCESSOIRES POUR	429, 432, 434
BAC À ALIMENTS ..155, 201, 318, 345, 349-350, 355, 365, 370, 409, 429, 438, 461		CHAFING DISH ECONOMIQUE	431
BAC GASTRONORME SANS BPA	204, 205	CHARIOT À CHARGES LOURDES	259
BAC GN ACIER ÉMAILLÉ	400	CHARIOT À DÉGIVRAGE	254
BAIN-MARIE	50, 313, 318, 433	CHARIOT À GLISSIÈRES	250-257
BALANCE	147	CHARIOT À GLISSIÈRES, DÉMONTABLE	251-253
BAMBOU NATUREL & BOIS	468, 469	CHARIOT À GLISSIÈRES, EMBOÎTABLE	251, 252
BANDE À SILICONE	198	CHARIOT À PLASTIQUE	244, 245, 260, 261
BAR KEEP®	498	CHARIOT AJUSTABLE	261
BARRE INTERMÉDIAIRE	192, 195	CHARIOT AVEC PLAN DE TREVALL	258
BARRE PORTE-BONS	124	CHARIOT DE DÉBARASSAGE	245, 246
BASSINE	154	CHARIOT DE SERVICE DÉMONTABLE	248
BASSINE PÂTISSIÈRE	155	CHARIOT DE SERVICE EN ALUMINIUM	245
BATTERIE À COULEURS	55	CHARIOT DOUBLE POUR PLATEAUX FAST-FOOD	256
BATTERIE BRONZE	399	CHARIOT EN BOIS	425-427
BATTERIE DE CUISINE / PRÉSENTATION	408-411	CHARIOT GUERIDON	426
BLACK FIRST	80	CHARIOT POUR PANIERS À VAISSELLE	259-260
BLACK PRO	78-79	CHARIOT TRANSPORT BAC GN	250-252, 258
BLACK SERIES	60	CHARIOTS DE SERVICE INOXYDABLE	246-249, 255
BOIS BLANVC, PLATEAU	371	CHARIOTS SPÉCIAUX	257-261
BOÎTE À CONDIMENT	499	CHEMINÉE	28
BOÎTE EN BOIS	387	CHINOIS À GAZE	116
BOÎTE PPE	213	CLIP D'IDENTIFICATION	228, 234, 235, 239, 240
BOL...221, 334, 337-339, 344-346, 348, 353-354, 356, 359-360, 362-363, 365-370, 380, 395, 437		COCKTAIL	496, 497
BOL POUR SNACKS	344, 352, 360, 380, 382, 479	COCOTTE	60
BOLS DE SERVICE ISOTHERMES À DOUBLE PAROI	221, 437	COCOTTE BLACK SERIES	60
BOLS NID D'ABEILLES À PAROI INCLINÉE	437	COCOTTES FONTE ALUMINIUM	459
BOUCHON À CHAMPAGNE	500	COLLECTIVITÉS	220-223
BOUCHON UNIVERSEL	500	CONTENEUR POUR SERVIETTES	419, 483, 515
BOUEILLE DE BAR	498, 500	COOL • LINE	55, 71
BRAISE	27-37	CORBEILLE PAIN	473-477
BROCHETTE	28, 482	CORBEILLES POLYPROPYLENE	474-477
BROSSE METALLIQUE	124	CORPS DE CHAUFFE POUR CHAFING DISH	432
BRÛLER ÉMAILLÉ	85	COUPE À GLACE	153
BUFFET CUBIC. CHARIOT BUFFET	425-427	COUPE EN CUBES	135
BUFFET CUBIC. CUBES ET TABLETTES	421	COUPE FRITES	131
BUFFET CUBIC. MEUBLE PRÉSENTOIR	419, 422, 423	COUPE FRYTES	137
CADDY DE TABLE	480	COUPE-OEUF	138
CAFETIÈRE	502-505	COUPE-ONIONS	133
CANNETTE ISOLANTE	507	COUPE-SALADE	132
CARAMÉLISER	160	COUP-FRUIT ET LÉGUMES	133
CASSE-NOIX	449	COUSCOUSSIER	51
CASSE-PATTES	449	COUTEAU	441, 443, 446
CASSEROLE ALUMINIUM	59	COUTEAU / ROULEAU (PIÈCE DE RECHNGE)	138
CASSEROLE BOMBÉE	46, 50, 59	COUTEAU À BEURRE	114
CASSEROLE COOL • LINE	55	COUVER-ASSIETTES EN PLASTIQUE	485
CASSEROLE FORME FRANÇAISE	49	COUVERCLE BATTERIE	33, 49, 399
CASSEROLE INOX-PRO	49-50	COUVERCLE GN	33, 197, 203, 205, 207-208
		COUVERCLE GRILLBOX	28

VOLLRATH

524

pujadas

Index

Índice

Index

français

ARTICLE	PAGE	ARTICLE	PAGE
COUVERCLE HERMET	33, 197	GANTS	149
COUVERCLE HERMET EASY OPEN	197	GARTRONORME POUR CHARIOT DÉGIVRAGE	254
COUVERCLE INOX-PRO	49	GASTRONORM INOXYDABLE	194-197
COUVERCLE POLINORM®	197, 203, 205, 207	GASTRONORME (MELAMINE)	374-378
COUVERCLE POUR COUPELLE DESSERT	221	GASTRONORME (POLYCARBONATE)	202-203
COUVERCLE POUR PANIER	236	GASTRONORME (POLYPROPYLENE)	206-207
COUVERCLES À ASSIETTE	485	GASTRONORME AVEC FOND THERMO-DIFFUSEUR	189, 199, 401
COUVERCLES À ASSIETTE	485	GASTRONORME VIOLET	208
COUVERCLES GN TRANSPARENTS	341, 397	GEL LUBRIFIANT SANITAIRE	139, 303
COUVRE-ASSIETTES INOX	485	GLACES	150-151, 322-327
CREMIÈRE	502-504	GN PASTRY PAN	154
CRÉPIÈRE	294	GOUTTIÈRE	169
CROCHET	118	GRILL	79, 80
CUILLÈRE	100, 101, 103-105, 157, 369, 380, 441-446	GRILL DE CONTACT	301
CUILLÈRE À COCKTAIL	497	GRILL PLAT AVEC POIGNÉES	79
CUILLÈRE À GLACE	152	GRILLE GN	92
CUILLÈRES À MESURER	144, 145	GRILLE PÂTISSERIE	88
CUILLÈRES À SERVIR	441-443, 444-446	HUILIÈRE	124
CUISEUR À RIZ	294	INOX-PRO	46-53
CUIT-PÂTES	52	KITS PRÉPARÉS DE ÉTEGÈRE	268-277
CUIT-VAPEUR INOX-PRO	52	KITS. CUBIC	415-417
DEMI-SPÉRIQUE	155	LAMPE CHAUFFANTE	315-317
DISTRIBUER À JUS	435	LIDSAVER®	510-515
DISTRIBUTEUR À LAIT	434, 435	LOUCHE	98, 369, 441-445
DISTRIBUTEUR À PRESSION	122, 123	MANDOLINES	139
DISTRIBUTEUR CONTRÔLE DE LA PARTIE	162	MARMITE ALUMINIUM	56-59
DISTRIBUTEUR DE CÉRÉALES	435	MARMITE BUFFET	314
DISTRIBUTEUR DES SAQUETTES THÉ & SUCRE. CUBIC	419	MARMITE COOL • LINE	52
DISTRIBUTEUR ET HOUSSES JETABLES	250	MARMITE INOX-PRO	48, 44
DISTRIBUTEUR SERVIETTES. CUBIC	419	MARMITE TRAITEUR AVEC ROBINET	52
DISTRIBUTEURS	162, 434, 435	MARMITES DE REMISE EN TEMPÉRATURE	306-313
DIVISEUR	134	MARMITES DE REMISE EN TEMPÉRATURE RÉTRO	308-309
DOSEUR À PRESSER	104	MARQUEURS	451
DOUILLE	171-174	MEDITERRANEAN	356
ECAILEUR	124	MELAMINE POUR PRÉSENTATION	334-383
ECUMOIRE	99, 100, 441-444	MÉLAMINE SLIM	376-377
EGOUTTOIRS POUR BACS GASTRONORME	195, 196, 203, 205, 254	MÉLANGEURS	302, 303
ELEGANCE	355	MÉLANGEURS DE COMPTOIR	302
ENCASTRÉE	289, 293	MESURE À COCKTAIL	497
ENTONNOIR	118, 162	MINIATURE FONTE ÉMAILLÉE	460-461
ENTONNOIR DOSEUR	162	MINIATURES ACIER ÉMAILLÉ	458
EPINGLE PORTE-TICKETS	482	MINIATURES ACIER INOXYDABLE	454-456
ETAGÈRES	268-277	MINIATURES MÉLAMINE	380-382
FAITOUT ALUMINIUM	58	MINUTEUR DE CUISINE	147
FAITOUT COOL • LINE	55	MIRAGE®	292-293, 306-309
FAITOUT INOX-PRO	48	MIRAGE® 3D INDUCTION	306-307
FLAP IDENTIFICATION	227	MIRAGE® INDUCTION WARMER	293
FLAP-RACK®	227, 228	MIRAMAR®	408-411
FONTAIN À CHOCOLAT	318	MIRAMAR® BATTERIE DE CUISINE / PRÉSENTATION	406-409
FOUET	156	MOULE À CAKE	163-165, 169, 182
FOUR À BRAISE	29-31	MOULE À FLAN	169
FOUR À MICRO-ONDES	294	MOULE À FLAN ÉVASSÉ	479
FOURCHETTE	101, 103, 441-443, 446	MOULE À NID	100
FOURS	29-31, 294	MOULE À OEUF	119
FRITEUSE	295	MOULE À PIZZA	93
FUEL POR CHAFING DISH	432	MOULE COEUR	168
GABARITS	41, 410-411	MOULE HEXAGONE	168
GANT À FOUR	149	MOULE LARME	168

VOLLRATH

525

pujadas

Index

Índice
Index

français

ARTICLE	PAGE	ARTICLE	PAGE
MOULE OVALE	165, 168	PLAQUE À PIZZA	93, 94
MOULES "FLEXIPAN" 175-181		PLAQUE À RÔTIR	88
MOULES À SILICONE 600 X 400	184-185	PLAQUE ALUMINIUM ANTI-ADHESIF	89, 91
MOULES DE SILICONE	182-185	PLAQUE CHAUFFANTE	318
MOULES PÂTISSERIE 163-165, 167-169, 177-189		PLAQUE GASTRONORME	89, 367, 465
MOULIN À LÉGUMES	118	PLAQUE INTERMÉDIAIRE INCLINÉE	329
MOULINS À POIVRE	481	PLAQUE RÉFRIGÉRANTE	433
MOULINS À SEL	481	PLAQUES À PIZZA	93
MULTIMÉTAL	50, 77	PLAQUES INDUCTION	284-293
NUMÉRO DE TABLE	481	PLAT À PAELLA ACIER ÉMAILLÉ	84
OICHET À EAU	508-509	PLAT À PAELLA ALUMINIUM	73
OUVRE-BOÎTES	138	PLAT À PAELLA EN TÔLE ACIER	84
PALETTE	99, 112, 113, 157, 441-446	PLAT À PAELLA INOX-PRO	48
PALETTE À FISH	99, 113	PLAT OVALE	345, 349-350, 355, 365, 370, 438, 461
PALETTE FAST-FOOD	113	PLATEAU	89-92, 220, 222-223, 335, 340-341, 343-344, 350-355, 360, 362, 364-367, 371-372, 380, 382
PANIER EN MÉTAL	471	PLATEAU DE PRESENTATION	342
PANIER FERMÉES	230-233	PLATEAU DE SERVICE	388, 389, 501
PANIER OUVERTS	234, 235	PLATEAU DE SERVICE ANTI-DÉRRAPANT	482, 501
PANIER POUR ASSITTES	238-240	PLATEAU FAST-FOOD	222
PANIER POUR COUVERTS	236, 237, 477	PLATEAU FORME OVALE	482
PANIER POUR PLATEAUX	240	PLATEAU ISOTHERMIC	256
PANIER POUR PLATEAUX ISOTHERMES	240	PLATEAU MARBRES NOIR	373
PANIER UNIVERSEL	236	PLATEAU PRÉSENTATION....	335, 340, 341, 345, 351, 371, 380, 395, 420, 467
PANIER, MÉTALIQUE	390	PLATEAU PRÉSENTATION. CUBIC	416-418, 420
PANNEAU INFORMATION	450	PLATEAU SELF-SERVICE ACIER INOX	222
PARE-HALEINE MOBILES	394	PLATEAUX EN FIBRE DE VERRE	222
PARE-HALEINE MOBILES EN ACRYLIQUE	394	PLATEAUX INOX PRÉSENTATION	464-465
PASSOIRE À COCKTAIL	497	POCHES PÂTISSIÈRES	170
PASSOIRE À POIGNÉES	117	POÊLE "LYONNAISE"	83
PASSOIRE À QUEUE	115-116	POÊLE À BLINIS	76
PELLE	28, 95, 99, 111, 113-114, 144, 342, 442, 444, 465, 497	POÊLE À CRÊPES	79, 80
PELLE À ENFOURNER	95	POÊLE ACIER INOXYDABLE	70-72
PELLE À FARINE	152, 155, 497	POÊLE ALUMINIUM	73-76
PELLE À FRITES	111	POÊLE ALUMINIUM FONTÉ	78-80
PELLE À GÂTEAU	114, 442, 444	POÊLE BLACK SERIES	78
PELLE À LÉGUMES	140	POÊLE COOL • LINE	71
PELLE GLAÇON	497	POÊLE HAUTE AVEC ANSES	84
PELLE MESURE	144	POÊLE IDEA	72
PELLE PRÉSENTATION	342, 465	POÊLE MULTIMÉTAL	69
PETIT PANIER POUR LES COUVERTS	237	POÊLE PUJADAS 1921	81
PICHET	507	POÊLES	62-83, 408
PICHET GRADUÉ	146	POLUCARBONATE DOUILLE	174
PICHET POLYCARBONATE	509	PORTE-BROCHETTES	35, 482
PIED PORTE-SEAU	493	PORTE-CARTES	484
PIED POUR BRÛLEUR	85	PORTE-MENU	484
PINCE	35, 95, 107-110, 168, 446, 447-449, 469, 497	POT À INFUSIONS	505
PINCE À GÂTEAU	448	POT MESUREUR	146
PINCE À VIANDE	449	POTEAU	450
PINCE BUFFET	108-109, 447	PRÉSENTOIR	386, 391-393
PINCE DE SERVICE	447	PRÉSENTOIR 3 NIVEAUX. CUBIC	417
PINCEAU	159	PRÉSENTOIR BACS GASTRONORME	198, 223, 379, 417
PINCES POUR PRÉSENTATION	107	PRÉSENTOIR BOLS MÉLAMINE. CUBIC	421
PIQUES SUPPORT PRÉSENTATION. CUBIC	418	PRÉSENTOIR BUFFET	339, 340, 395
PLANCHE À DÉCOUPER	140-142	PRÉSENTOIR DE TARTES	161
PLANCHE À DÉCOUPER VIOLET	142	PRÉSENTOIR GN BAMBOU	391
PLAQUE "DÉFENSE DE FUMER" 481		PRÉSENTOIR GRANITE-ARDOISE	373
PLAQUE "RESERVÉ" 481			
PLAQUE À PÂTISSERIE	90-92, 351		

Index

Índice
Index

français

ARTICLE	PAGE	ARTICLE	PAGE
PRESSE CITRON	497	SUPPORT POUR POCHE PÂTISSIER	170
PROCESSEUR VERSATILE ET MANUEL	137	SUPPORT RAMASSE-COUVERTS	223, 237, 257, 420, 427
PROTECTRICE EN VINYLE	261	TABLE À DÉCOUPER	140-142
PUJADAS 1921. FONTE ULTRALÉGER INDUCTION	81	TABLE EN BOIS	462
RACLETTE 113-114		TABLEAUX	451
RAMASSE-COUVERTS	223	TAMIS	161
RAMASSE-COUVERTS POUR CHARIOT SERVICE	246	TAPIS	149
RAMASSE-MIETTES	483	TAPIS ANTIDÉRAPANT	501
RAMEQUIN	145, 337, 380, 463, 477, 479, 480	TAPIS DE BAR	498
RÂPE	120-121	TASSE	221, 369
RECEPTALBE À DÉCHETS	483	TASSE GRADUÉE	145, 146
RÉCHAUD	257, 321	TCHARIOT BOISSON	489, 490
RÉCIPIENT À GLACE	153	TERRACOTA	352-353
RECTANGLE POUR PLAQUES INOX	90	THÉIÈRE	503, 504-505
REFRAÎCHISSEUR	495	THÉIÈRE AVEC FILTRE	504
REFRAÎCHISSEUR BOUTEILLES. CUBIC	418	THERMOMÈTRE	147-148
REFRAÎCHISSEUR ISOTHERME	493	TIRE-BOUCHONS	500, 502
ROBOT MULTIFUNCTION	302-303	TIRE-BOUCHONS MUR	502
ROULEAU	158-159	TOASTEUR	296-300
ROULETTE À PÂTES	158, 166-168	TOILE DE CUISSON	95
ROULETTE À PIZZA	113	TORCHE À CARAMÉLISER	160
RUBAN PÂTISSIER	168	TORCHON EN SILICONE	149
SACS À DOS DE LIVRAISON	218-219	TRANCHES ET CUBES	129, 130
SACS À PIZZAS	214, 215	TRANCHEUR ÉLECTRIQUE	303
SACS DE TRAITEUR	216, 217	TRIBUTE	45, 69
SALADIER	439	TURBINE À GLACE	326
SAUCIÈRE	479	T-VERSION	228-233
SAUPOUDREUSES	123	USTENSILS DE SERVICE	440-449
SAUTEUSE ALUMINIUM	59	VERRE	221, 356, 457, 496
SAUTEUSE INOX-PRO	50	VERSATIL MACHINE	135
SEAU À CHAMPAGNE	491, 492, 494, 495	VERSEUSE À POMPE	506
SEAU Á CHAMPAGNE EN PLASTIQUE	494-495	VIDE / COUPE POMMES	138
SEAU À CHAMPAGNE, COMPLEMENTS	500	VIOLET COLLECTION	208
SEAU À GLAÇONS	493	VITRINES À PÂTISSERIES	396, 397
SEAU AVEC BASE	146	VITRINES EN VERRE	321
SEAUX À VIN	491, 492, 494, 495	VITRINES PRÉSENTATION	402
SÉPARATEUR DE PORTIONS	160	WOK ACIER	83
SETS DE TABLE	478	WOK BLACK SERIES	79
SHAKER	496	WOK INOX	72
SOLUTIONS DE DISTRIBUTION	510-515	WOK MULTIMÉTAL	77
SOUPIÈRE	439	WOK STEEL PRO	81
SPATULE GÉANTE	124		
SPOODLE®	102-103, 105		
STATIONS POUR BUFFET	317		
STONE	354		
STOP GOUTTES	500		
SUCRIER	503		
SUPER PAN® 3	201		
SUPER PAN® SUPER SHAPES	200-201		
SUPPORT À PIQUES. CUBIC	419		
SUPPORT DE TABLE POU SEAUX	495		
SUPPORT NUMÉRO	481		
SUPPORT POUR BACS GN	258, 427		
SUPPORT POUR BACS GN	198, 379		
SUPPORT POUR COUVERCLES GN	202		
SUPPORT POUR ENTONNOIR OU CHINOIS	116		
SUPPORT POUR GRANDS PLATEAUX	482		
SUPPORT POUR PLANCHES À DÉCOUPER	202		

Numerical index

Índice numérico
Index numérique

REF.	PAG.	REF.	PAG.	REF.	PAG.	REF.	PAG.	REF.	PAG.
0644N	137	19196	392	40770	303	46656	145	47157	152
0654	137	2208-13	122	40771	303	46657	145	47158	152
1009-01	228	2212-13	122	40772	303	46658	145	47159	152
1009-02	228	2224-13	122	40773	303	46659	145	47160	152
1009-03	228	2331-99	498	40774	303	46661	145	47161	152
1009-04	228	26120-13	123	40775	303	46665	437	47169	152
1009-05	228	26240-13	123	40776	303	46666	437	47170	152
1009-06	228	26320-13	123	40862	321	46667	437	47171	152
1009-08	228	2803-18	162	40863	321	46671	317	47172	152
1009-19	228	2808-13	122	434	132	46672	317	47200	152
1009-32	228	2812-13	122	435	132	46787	497	47274	152
1078-13	485	2908-13	123	4400N	132	46789	500	47275	152
1100-13	485	2912-13	123	4408	132	46790	497	47276	152
1200-13	485	306	134	44572	144	46791	496	47277	152
1400	139	308	134	45603-1	131	46793	496	47278	152
1420-01	501	3100020	404	45749-1	131	46861	429	47279	152
1474-0606	501	3100040	404	45750-1	131	4689760	105	47309	108
1476-0606	501	3100220	404	45751-1	131	4689815	105	47312	108
15000	130	3100240	404	46009	393	4689830	105	47316	108
15001	130	3100320	404	4600960	393	4689840	105	47322	110
15002	130	3100321	404	46070	431	4689850	105	47325	111
15005	130	3100340	404	46080	431	4689860	105	47326	110
15006	130	3100341	404	46093	434	4689960	105	47370	104
15007	130	3101015	403	46094	434	46905	444	47371	104
15016	130	3101020	403	46095	431	46907	444	47372	104
15017	130	3101040	403	46110	318	46909	444	47390	104
15050	130	3101120	403	46110	432	46926	447	47391	104
15052	130	3101220	403	46115	318	46928	448	47392	104
15053	130	3101240	403	46115	432	46929	449	47393	104
15054	130	3102015	403	46124	429	46936	444	47394	104
15055	130	3102020	403	46125	429	46938	447	47395	104
15058	130	3102040	403	46131	429	46952	444	47396	104
15059	130	3102120	404	46132	429	46960	444	47397	104
15060	130	3102220	403	46134	429	46988	447	47398	104
15061	130	3316-13	122	46137	429	46989	447	47399	104
15062	130	3324-13	122	46221	438	47002	156	47400	104
15063	130	3332-13	122	46285	434	47003	156	47401	104
15064	130	3616	498	4635110	434	47004	156	47402	104
15065	130	3628	498	4635210	435	47005	156	47403	104
15067	130	3632	498	4635810	434	47025	144	47404	104
15068	130	3648	498	4644010	428	47026	144	4741-06	499
15069	130	3664	498	4644020	428	47027	144	4743-06	499
15070	130	3805-06	513	46527	309	47028	144	4747	499
15072	130	3820-28	513	46569	437	47029	144	47488	307
15073	130	400N	132	46582	437	47031	144	47488	312
15076	130	401N	132	46584	437	47046	111	47490	307
15078	130	402NC	132	46585	437	47049	111	47490	312
15081	130	403NH	133	46586	437	47054	144	47602	500
15082	130	4075502	302	46587	437	47058	144	47611	493
15083	130	4075503	302	46588	144	47104	497	47619	437
15085	130	4075602	302	46589	145	47118	145	47620	491
15086	130	4075603	302	46590	437	47119	145	47632	437
15103	137	4075702	303	4659015	437	47139	104	4763215	437
15104	137	4075703	303	4659050	437	47140	104	4763250	437
15105	137	4075802	303	4659060	437	47141	104	4763260	437
15113	137	4075803	303	46591	437	47142	104	47634	437
15114	137	4075902	303	4659115	437	47143	104	4763415	437
15115	137	4075903	303	4659150	437	47144	104	4763450	437
15149	139	40761	302	4659160	437	47145	104	4763460	437
15209	137	40762	302	46592	437	47146	104	47635	437
15601	133	40763	302	4659215	437	47150	152	4763515	437
15604	133	40764	302	4659250	437	47151	152	4763550	437
1612-06	501	40765	303	4659260	437	47152	152	4763560	437
1697	260	40766	303	46599	508	47153	152	47637	437
1811	135	40767	303	46622	500	47154	152	47703	131
1812	135	40768	303	46654	145	47155	152	47713	131
1823	135	40769	303	46655	145	47156	152	47714	131

Numerical index

Índice numérico
Index numérique

REF.	PAG.	REF.	PAG.	REF.	PAG.	REF.	PAG.	REF.	PAG.
47715	131	49417	408	55477	129	6422655	103	700-4	134
4780610	110	49418	408	55478	129	6422865	103	702111	45
4780620	109	49419	409	55479	129	6432120	103	702115	45
4780630	109	49420	409	55480	129	6432220	103	702125	45
4780640	109	49423	409	55481	129	6432230	103	702135	45
4780650	109	49424	408	55482	129	6432335	103	702145	45
4780660	109	49425	408	55483	129	6432420	103	704	134
4780670	109	49426	409	55484	129	6432445	103	706	134
4780910	110	49427	409	55485	129	6433120	103	708	134
4780912	110	49428	408	55486	129	6433220	103	712	134
4780920	109	49429	409	55490	129	6433230	103	7217310	309
4780922	110	49430	408	55491	129	6433335	103	7217350	309
4780930	109	49431	409	55492	129	6433445	103	7217355	309
4780940	109	49432	409	55493	129	6433480	103	7217360	309
4780950	109	49433	409	55494	129	6433620	103	7217410	309
4780960	109	49435	409	595027502	293	6433655	103	7217450	309
4780970	109	49441	408	595027503	293	6433865	103	7217455	309
4780980	109	49442	409	595087502	293	64403	444	7217460	309
4781210	110	49445	409	595087503	293	64404	444	7217810	309
4781212	110	4961-1301	123	59601	289	64406	444	7217850	309
4781220	109	4961-1308	123	59602	289	64407	444	7217855	309
4781222	110	4961-13191	123	59641	293	6512-06	515	7217860	309
4781230	109	4961-1332	123	59642	293	6535-13	515	7217910	309
4781240	109	4980120	98	59650	289	6706CC	93	7217950	309
4781250	109	4980230	98	59651	289	6706HC	93	7217955	309
4781260	109	4980335	98	606N	134	6706N	93	7217960	309
4781270	109	4980422	309	62300	485	6708CC	93	72522	312
4781280	109	4980445	98	62301	485	6708HC	93	72550	313
4781610	110	4980622	309	62303	485	6708N	93	72630	313
4781612	110	4980655	98	62305	485	6709CC	93	74110210	307
4781620	109	4980865	98	62309	485	6709N	93	74110240	307
4781622	110	500N	133	62311	485	6710CC	93	741102D	307
4781630	109	501N	133	62312	485	6710N	93	74110310	307
4781640	109	509	133	62313	485	6712CC	93	74110340	307
4781650	109	511	133	62314	485	6712N	93	741103D	307
4781660	109	52160	507	62315	485	671307	68	7470210	307
4781670	109	52162	507	62318	485	671308	68	7470240	307
4790910	110	52164	507	62321	485	671310	68	74702D	307
4791210	35	52170	507	62322	485	671312	68	7470310	307
4791210	110	52172	507	62323	485	671314	68	7470340	307
4791610	35	52174	507	62325	485	6714CC	93	74703D	307
4791610	110	5220	92	62326	485	6714HC	93	75013	404
47933	155	5223	92	62327	485	6714N	93	75015	404
47934	155	5228	92	62328	485	6716CC	93	7512-06	515
47935	155	52291	260	6412120	103	6716HC	93	77519	45
47938	155	52640	237	6412230	103	6716N	93	77520	45
47943	155	52641	237	6412335	103	68296	146	77521	45
4806-01	514	52642	237	6412420	103	68297	146	77522	45
4806-06	514	52643	237	6412445	103	68351	146	77523	45
48070	496	5283520	105	6412520	103	68352	146	77760	45
4808820	112	5283620	105	6412655	103	691407	69	77761	45
4808920	112	5283720	105	6412865	103	691408	69	78204	312
48144	443	5283920	105	64130	101	691410	69	78710	433
48148	443	5284120	112	64132	101	691412	6		

Numerical index

Índice numérico
Index numérique

REF.	PAG.	REF.	PAG.	REF.	PAG.	REF.	PAG.	REF.	PAG.
8242010	410	90212	200	CT4-23080003	297	M1-L-T1	511	P100861	476
8242014	410	90213	201	CT4-230DUAL	296	M2V-LL-T1-T1	511	P100862	476
8242310	410	90222	200	CT4H-230950	296	M3V-LLL-T1-T1-T1	511	P100871	476
8242314	410	90223	201	CTC-3X2V	515	M4V-4L-T1-T1-T1-T1	511	P100880	476
8242414	410	90242	200	CTCL-4B	514	MBA92821	394	P100881	476
8242514	410	90243	201	CTFWH-8B	514	N-0001B	198	P100882	476
8242610	410	90252	200	CTNO-06	515	N-0002B	198	P100890	476
8242614	410	90262	200	G58807	514	N-0003B	198	P100891	476
8242710	410	90263	201	HPI4-260002	288	N-0006B	198	P100892	476
8242714	410	90282	200	HPI4-260003	288	P1	511	P100900	475
8242810	411	90302	201	HPI4-260004	288	P100003P	198	P100931	477
8242814	411	90312	201	HPI4-300002	288	P100004P	198	P100932	477
8242914	411	90322	201	HPI4-300003	288	P100005P	198	P100940	477
8243014	411	90342	201	HPI4-300004	288	P100006P	198	P100950	477
8243114	411	90352	201	HPI4-380002	288	P100008P	198	P100951	477
8243210	411	90362	201	HPI4-380003	288	P100511	468	P100955	477
8243214	411	90382	201	HPI4-380004	288	P100512	468	P100960	477
8243314	411	90402	201	INC-80	511	P100520	468	P100965	477
86100	222	90412	201	INC-80	513	P100521	468	P103322	59
86101	222	90422	201	INC-80S18	513	P100522	468	P104318	59
86103	222	90442	201	J1-L-T5	512	P100530	469	P104320	59
86104	222	90452	201	J2H-LL-T5-T5	512	P100531	469	P104324	59
86105	222	90462	201	J2V-LL-T5-T5	512	P100540	469	P106320	59
86106	222	90482	201	J3V-LLL-T5-T5-T5	512	P100541	469	P106324	59
86107	222	90502	200	K1-L	511	P100542	469	P109035	117
86108	222	90512	200	K1LLDS-T1	512	P100543	469	P109040	117
86109	222	90522	200	K2H-LC-T1-T2	511	P100544	469	P109045	117
86110	222	90542	200	K2H-LL-T1-T1	511	P100550	469	P109050	117
86111	222	90552	200	K2H-LP-T1-T4	511	P100551	469	P110000	197
86113	222	90562	200	K2V-LCLDS-T1-T2	512	P100552	469	P110004	197
86114	222	90622	201	K2V-LC-T1-T2	511	P100553	469	P110004A	33
86115	222	90642	201	K2VLLDS-T1-T1	512	P100554	469	P110004EO	197
86116	222	90662	201	K2V-LL-T1-T1	511	P100570	469	P110005	197
86117	222	90682	201	K2V-LP-T1-T4	511	P100571	469	P1100BF	205
86118	222	90922	201	K3H-LCC-T1-T2-T2	511	P100572	469	P1100C1	203
86119	222	90942	201	K3H-LCP-T1-T2-T4	511	P100600	468	P1100C1	207
86120	222	918-13	485	K3H-LCS-T1-T2-T3	511	P100601	468	P1100P1	197
86121	222	93100	201	K3H-LLL-T1-T1-T1	511	P100740	474	P1100P1	203
86123	222	93110	201	K3V-LCLDS-T1-T2-T2	512	P100741	474	P1100P1	205
86124	222	93200	201	K3V-LCC-T1-T2-T2	511	P100742	474	P1100P1	207
86125	222	93300	201	K3V-LCP-T1-T2-T4	511	P100754	474	P1100P2	197
86126	222	93400	201	K3V-LCS-T1-T2-T3	511	P100755	474	P1100P2	203
86127	222	93500	201	K3V-LLL-T1-T1-T1	511	P100760	474	P1100P3	197
86128	222	93600	201	K4H-LCCC-T1-T2-T2-T2	511	P100761	474	P1100P3	203
86129	222	93900	201	K4H-LCCP-T1-T2-T2-T4	511	P100770	474	P1100P4	197
88184	307	95160	146	K4H-LCCS-T1-T2-T2-T3	511	P100780	474	P1100P4	203
88204	307	95320	146	K4H-LLCC-T1-T1-T2-T2	511	P100792	475	P1100P5	197
90002	200	95640	146	K4V-LCCC-T1-T2-T2-T2	511	P100803	475	P1100P5	203
90012	200	97004	245	K4V-LCCP-T1-T2-T2-T4	511	P100804	475	P1100P6	208
90013	201	97005	245	K4V-LCCS-T1-T2-T2-T3	511	P100805	475	P110101	154
9002	92	97006	245	K4V-LLCC-T1-T1-T2-T2	511	P100807	473	P110101	194
90022	200	97007	245	K4X-LCCC-T1-T2-T2-T2	511	P100808	473	P110201	194
90023	201	97168	249	K4X-LCCP-T1-T2-T2-T4	511	P100813	475	P110202	196
90042	200	97181	247	K4X-LCCS-T1-T2-T2-T3	511	P100814	475	P110401	194
90043	201	97208	249	K4X-LLCC-T1-T1-T2-T2	511	P100816	473	P110402	196
90052	200	99710	237	LD2-2	513	P100817	473	P110551	194
90053	201	ADC-4	261	LD3-2	513	P100820	475	P110552	196
90062	200	ADP	261	LDS-3	515	P100821	475	P110651	194
90063	201	CADJ-1	513	LDS-4CUP	515	P100826	473	P110652	196
90082	200	CADJ-2	513	LS03IB-T1	512	P100827	473	P1106BF	204
90102	200	CADJ-3	511	LS03IS18B-T1	512	P100836	473	P1106C1	202
90112	200	CADJ-3	513	LS03IVB-T1	512	P100837	473	P1106F1	199
90122	200	CFIFO-4	515	LS03MS18B-T5	512	P100838	473	P1106F3	401
90142	200	CT2-23035002	297	LS03MVS18B-T5	512	P100840	476	P1106F3A	401
90162	200	CT2-23035003	297	LS03PB-T1	512	P100841	476	P1106F3G	401
90182	200	CT4-2301000	297	LS03PS18B-T1	512	P100851	476	P1106F3N	401
90202	200	CT4-23080002	297	LS03PVB-T1	512	P100860	476	P1106F3R	401

Numerical index

Índice numérico
Index numérique

REF.	PAG.	REF.	PAG.	REF.	PAG.	REF.	PAG.	REF.	PAG.
P1106P1	206	P118335	58	P121501	194	P1300P1	197	P1400C1	203
P111001	194	P118340	58	P121502	196	P1300P1	203	P1400C1	207
P111002	196	P118345	58	P1215BF	204	P1300P1	205	P1400P1	197
P1110BF	204	P118350	58	P1215C1	202	P1300P1	207	P1400P1	203
P1110C1	202	P118360	58	P1215P1	206	P1300P2	197	P1400P1	205
P1110F1	199	P120000	197	P1215P6	208	P1300P2	203	P1400P1	207
P1110F2	199	P120004	197	P122001	194	P1300P3	197	P1400P2	197
P1110P1	206	P120004A	33	P122002	196	P1300P3	203	P1400P2	203
P111111	195	P120004EO	197	P122004	88	P1300P4	197	P1400P3	197
P111501	194	P120005	197	P122050	88	P1300P4	203	P1400P3	203
P111502	196	P120018	74	P122060	88	P1300P5	197	P1400P4	197
P1115BF	204	P120020	74	P1220BF	204	P1300P5	203	P1400P4	203
P1115C1	202	P120022	74	P1220C1	202	P1300P6	208	P1400P5	197
P1115F1	199	P120024	74	P1220P1	206	P130201	194	P1400P5	197
P1115F2	199	P120026	74	P122222	195	P130202	196	P1400P1	203
P1115P1	206	P120028	74	P123040	91	P130401	194	P140651	195
P1115P6	208	P120032	74	P123060	91	P130402	196	P1406BF	204
P112001	194	P120036	74	P123140	91	P130651	194	P1406C1	202
P112002	196	P120040	74	P123160	91	P130652	196	P1406P1	207
P112002	204	P120040	205	P123260	91	P1306BF	204	P141001	195
P1120C1	202	P1200C1	203	P124024	75	P1306C1	202	P141014	60
P1120P1	206	P1200C1	207	P124028	75	P1306P1	207	P141014	459
P112324	59	P1200P1	197	P124032	75	P131001	194	P141016	60
P112328	59	P1200P1	203	P124036	75	P131002	196	P141016	459
P112332	59	P1200P1	205	P124040	75	P131022	76	P141020	60
P112335	59	P1200P1	207	P125000	195	P131026	76	P141020	459
P112340	59	P1200P2	197	P125038	76	P1310BF	204	P141024	60
P112345	59	P1200P2	203	P1250BF	205	P1310C1	202	P141024B	399
P112350	59	P1200P3	197	P1250C1	203	P1310P1	207	P141028	60
P112360	59	P1200P3	203	P127024	75	P131120	400	P141028B	399
P113035	88	P1200P4	197	P127028	75	P131165	400	P141032	60
P113040	88	P1200P4	203	P127032	75	P131220	400	P141032B	399
P113050	88	P1200P5	197	P127040	75	P131265	400	P141036	60
P113060	88	P1200P5	203	P128018	74	P131501	194	P141040	60
P113070	88	P1200P6	208	P128020	74	P131502	196	P1410BF	204
P114040	88	P120101	154	P128022	74	P1315BF	204	P1410C1	202
P114050	88	P120101	194	P128024	74	P1315C1	202	P1410P1	207
P114060	88	P120201	194	P128026	74	P1315P1	207	P14126	239
P114070	88	P120401	194	P128028	74	P1315P6	208	P14126F1	239
P114540	88	P120651	194	P128032	74	P132001	194	P141501	195
P114545	88	P120652	196	P128036	74	P132002	196	P1415BF	204
P115000	195	P1206BF	204	P128040	74	P132040	91	P1415C1	202
P115000	254	P1206C1	202	P128124	75	P132060	91	P1415P1	207
P1150BF	205	P1206F1	199	P128128	75	P1320C1	202	P142000	80
P1150C1	203	P1206F3	401	P128132	75	P1320P1	207	P142001	195
P115320	58	P1206F3A	401	P128224	75	P132140	91	P142100	79
P115324	58	P1206F3G	401	P128228	75	P132160	91	P145000	195
P115340	58	P1206F3N	401	P128232	75	P132260	91	P1450BF	205
P116324	58	P1206F3R	401	P128324	75	P132365	89	P1450C1	203
P116328	58	P1206P1	206	P128328	75	P132560	89	P148020	75
P116332	58	P120820	75	P128332	75	P135000	195	P148024	75
P116335	58	P120824	75	P128424	75	P1350BF			

Numerical index

Índice numérico
Index numérique

REF.	PAG.	REF.	PAG.	REF.	PAG.	REF.	PAG.	REF.	PAG.
P15004	301	P160004	197	P19100	450	P203024	50	P214016	49
P15005	301	P1600BF	205	P191001	195	P204020	50	P214018	49
P15006	301	P1600C1	203	P19101	450	P204024	50	P214020	49
P15007	301	P1600C1	207	P19103	450	P204028	50	P214022	49
P15008	301	P1600P1	197	P19104	450	P204030	50	P214024	49
P15010	318	P1600P1	203	P19105	450	P204032	50	P215000	195
P150128	79	P1600P1	205	P19106	450	P204035	50	P215000	254
P15020	313	P1600P1	207	P19107	450	P204040	50	P216016	48
P15027	321	P1600P2	197	P1910BF	205	P205020	48	P216018	48
P15028	321	P1600P2	203	P1910C1	203	P205024	48	P216020	48
P15029	315	P1600P3	197	P1910P1	207	P205028	48	P216024	48
P15030	315	P1600P3	203	P19114A	450	P205030	48	P216028	48
P15033	316	P1600P4	197	P19114N	450	P205032	48	P216030	48
P15034	316	P1600P4	203	P19114R	450	P205035	48	P216032	48
P15035	294	P1600P5	197	P19115A	450	P205040	48	P216035	48
P15038	299	P1600P5	203	P19115N	450	P205045	48	P216040	48
P15039	299	P1600P6	208	P19115R	450	P205050	48	P216045	48
P15040	300	P160651	195	P19116	450	P205060	48	P216050	48
P15041	300	P1606BF	205	P19117	450	P209016	49	P216060	48
P15042	299	P1606C1	203	P19118	450	P209018	49	P217016	48
P15070	295	P1606P1	207	P19120	394	P209020	49	P217018	48
P15071	295	P161001	195	P19126	239	P209020A	33	P217020	48
P15072	290	P161034	60	P19126F1	239	P209024	49	P217024	48
P15073	318	P161038	60	P193918	76	P209024A	33	P217028	48
P15074	318	P1610BF	205	P193920	76	P209028	49	P217030	48
P15075	294	P1610C1	203	P193922	76	P209028A	33	P217032	48
P15077	291	P1610P1	207	P193924	76	P209030	49	P217035	48
P15078	290	P161501	195	P193926	76	P209032	49	P217040	48
P15079	291	P1615BF	205	P193928	76	P209032A	33	P217045	48
P15081	294	P1615C1	203	P193932	76	P209035	49	P217050	48
P15089	303	P1615P1	207	P193936	76	P209040	49	P217060	48
P15090	303	P1615P6	208	P195000	465	P209045	49	P218016	48
P15091	303	P162001	195	P200012	49	P209050	49	P218018	48
P15096	318	P1650BF	205	P200014	49	P209060	49	P218020	48
P15097	318	P166032	81	P200016	49	P21000	451	P218024	48
P151012	60	P169020	81	P200018	49	P21001	451	P218028	48
P151012	459	P169024	81	P200020	49	P21003	451	P218030	48
P151014	60	P169028	81	P200022	49	P21005	451	P218032	48
P151014	459	P169030	81	P200024	49	P21015	451	P218035	48
P151016	60	P170020	61	P200028	49	P21016	451	P218040	48
P151016	459	P170024	61	P200116	49	P21017	451	P218045	48
P151020	60	P170028	61	P200120	49	P21020	451	P218050	48
P151020B	399	P171024	61	P200320	50	P210201	194	P218060	48
P151024	60	P171028	61	P200324	50	P210202	196	P22000	367
P151024B	399	P173016	61	P20041	484	P21027	451	P22001	367
P151028	60	P190000	197	P20042	484	P21028	451	P220018	70
P151028B	399	P1900BF	205	P20050	484	P210401	194	P22002	366
P151032	60	P1900C1	203	P20066	484	P210402	196	P220020	70
P15105	239	P1900C1	207	P20069	484	P210651	194	P220021	366
P15105F1	239	P1900P1	197	P20072	419	P210652	196	P220022	70
P151100	459	P1900P1	203	P201016	49	P211001	194	P220023	366
P151200	459	P1900P1	205	P201018	49	P211002	196	P220024	70
P151300	459	P1900P1	207	P201020	49	P21105	239	P220026	70
P151400	459	P1900P2	197	P201024	49	P21105F1	239	P220028	70
P152025	88	P1900P2	203	P201028	49	P211501	194	P22003	365
P152030	88	P1900P3	197	P201032	49	P211502	196	P220031	365
P152035	88	P1900P3	203	P20115	239	P212001	194	P220032	70
P152035B	399	P1900P4	197	P20115F1	239	P212002	196	P220033	365
P152935	399	P1900P4	203	P202016	49	P213018	71	P220036	70
P153025	79	P1900P5	197	P202018	49	P213020	71	P22004	367
P153034	79	P1900P5	203	P202020	49	P213022	71	P220040	70
P153050	79	P19060	394	P202024	49	P213024	71	P22005	367
P154020	399	P190651	195	P202028	49	P213026	71	P22006	378
P154024	399	P1906BF	205	P202032	49	P213028	71	P22007	378
P154028	399	P1906C1	203	P203016	50	P213032	71	P22008	378
P154032	399	P1906P1	207	P203018	50	P213036	71	P22009	375
P160000	197	P19090	394	P203020	50	P213040	71	P22010	375

Numerical index

Índice numérico
Index numérique

REF.	PAG.	REF.	PAG.	REF.	PAG.	REF.	PAG.	REF.	PAG.
P22011	375	P22117	369	P22250	369	P22362	395	P22420	362
P22012	367	P22118	369	P22251	369	P22363	340	P22421	362
P22013	367	P22119	380	P22301	345	P22363	395	P22422	345
P22014	367	P22120	382	P22302	345	P22364	370	P22423	345
P22015	367	P22124	373	P22303	345	P22364	395	P22424	342
P22016	367	P22125	373	P223035	52	P22365	370	P22425	342
P22019	370	P22126	373	P22304	345	P22365	395	P22426	342
P22020	370	P22127	342	P223040	52	P22366	340	P22427	342
P22022	370	P22128	342	P22305	345	P22366	395	P22501	365
P22023	370	P22129	342	P22306	345	P22367	340	P22502	365
P22030	383	P22144	373	P22307	345	P22367	395	P22600	371
P22031	383	P22145	373	P22308	344	P22368	337	P22601	371
P22033	369	P22150	367	P22309	344	P22369	337	P22602	371
P22034	369	P22151	367	P22310	348	P22370	337	P22603	371
P22035	383	P22154	379	P22311	348	P22370A	359	P22604	371
P22036	383	P22156	379	P22312	348	P22370G	359	P22610B	371
P22037	364	P22158	379	P22313	348	P22370N	359	P22610N	371
P22038	364	P22160	379	P22314	348	P22370R	359	P22611B	371
P22039	375	P22161	372	P22315	348	P22371	337	P22611N	371
P22040	378	P22162	372	P22316	348	P22371A	359	P22614B	371
P22041	375	P22164	364	P22317	348	P22371G	359	P22614N	371
P22042	378	P22165	364	P22318	347	P22371N	359	P22620	371
P22043	375	P22166	364	P22319	347	P22371R	359	P22621	371
P22044	378	P22167	365	P22320	347	P22372	337	P22622	371
P22045	375	P22168	365	P22321	347	P22373	341	P22640N	372
P22046	378	P22169	363	P22322	343	P22374	341	P22641N	372
P22047	375	P22170	363	P22323	343	P22375	341	P22642N	372
P22048	378	P22171	363	P22324	343	P22376	341	P22650	342
P22049	375	P22172	363	P22325	343	P22377	334	P22651	342
P22050	378	P22173	363	P22326	343	P22378	334	P22652	342
P22051	375	P22174	370	P22327	343	P22379	334	P22660	371
P22052	378	P22175	370	P22328	343	P22380	334	P22661	371
P22053	375	P22176	370	P22329	346	P22381	334	P22662	371
P22054	378	P22177	365	P22330	346	P22382	334	P22663	371
P22079	378	P22178	369	P22331	346	P22384	334	P22664	371
P22080	375	P22179	369	P22332	347	P22385	334	P22690	372
P22081	378	P22180	369	P22333	346	P22386	334	P22691	372
P22082	375	P22181	369	P22334	346	P22387	334	P22692	372
P220820	71	P22182	368	P22335	346	P22388	334	P22695	373
P220824	71	P22183	368	P22336	350	P22389	334	P22696	373
P220828	71	P22184	368	P22337	350	P22390	334	P22697	373
P22083	378	P22185	383	P22338	350	P22391	334	P22698	373
P220832	71	P22200	366	P22339	350	P22393	334	P22700	353
P22084	375	P22200A	366	P22340	350	P22394	334	P22701	353
P22085	367	P22200AM	366	P22341	350	P22399	339	P22702	353
P22086	367	P22200N	366	P22342	350	P22400	339	P22703	353
P22087	378	P22200R	366	P22343	350	P22401	339	P22704	353
P22088	380	P22200V	366	P22344	349	P22402	339	P22705	353
P22090	370	P22201	366	P22345	349	P224023	52	P22710	353
P22094	378	P22202	366	P22346	349	P224026	52	P22711	353
P22099	367	P22202A	366	P22347	349	P22403	339	P22712	353
P22100	365	P22202AM	366	P22348	349	P22404	338	P22720	356
P22101	365	P22202N	366	P22349	362	P22405	338	P22725	356
P22102	365	P22202R	366	P22350	362	P22406	338	P22726	356
P22103	364	P22202V	366	P22351	362	P22407	338	P22727	356
P22104	380	P22203	366	P22352	362	P22408	338	P22728	356
P22105	380	P22203A	366	P2					

Numerical index

Índice numérico
Index numérique

REF.	PAG.	REF.	PAG.	REF.	PAG.	REF.	PAG.	REF.	PAG.
P22755	352	P22885	349	P23500	460	P24705	455	P301165	98
P22756	352	P22886	349	P235000	195	P24706	455	P301206	98
P22758	356	P22887	349	P23501	460	P24707	455	P301208	98
P22759	356	P22888	344	P23502	460	P24708	455	P301210	98
P22760	352	P22889	344	P23503	460	P24709	455	P301212	98
P22770	353	P22890	380	P23504	461	P24710	455	P301214	98
P22772	353	P22891	344	P23505	461	P24711	455	P301216	98
P22775	351	P22892	344	P23506	461	P24712	455	P302108	99
P22778	351	P22893	344	P23507	461	P24713	455	P302110	99
P22779	351	P22894	344	P23508	461	P24714	454	P302112	99
P22780	355	P22895	345	P23509	461	P24715	454	P302114	99
P22781	355	P22896	344	P23800	381	P24716	454	P302116	99
P22782	355	P22897	344	P23800A	358	P24717	454	P302118	99
P22783	355	P22898	344	P23800G	358	P24718	454	P302120	99
P22784	355	P22899	344	P23800N	358	P24719	454	P302210	99
P22800	354	P22901	360	P23800R	358	P248028	52	P302212	99
P22801	354	P22902	360	P23810	381	P248032	52	P302214	99
P22802	354	P22911	360	P23824	381	P248035	52	P302216	99
P22803	354	P22912	360	P23825	381	P248040	52	P303016	116
P22815	354	P22920	382	P23830	381	P248045	52	P303018	116
P22816	354	P22930	382	P23835	381	P26000	149	P303020	116
P22817	354	P22940	360	P23836	381	P26001	149	P303022	116
P22823	354	P22950	360	P23840	381	P26100	498	P303024	116
P22824	354	P22960	360	P23841	381	P28202	467	P303026	116
P22825	354	P22971	360	P23842	382	P28252	467	P303200	116
P22830	357	P22972	360	P23843	382	P28302	467	P303265	98
P22833	357	P22973	363	P23844	382	P28303	467	P306035	154
P22834	357	P22974	363	P23845	382	P28403	467	P307020	154
P22835	357	P22975	363	P239036	77	P28501	467	P307025	154
P22838	357	P22999	353	P239136	77	P28502	467	P307030	154
P22839	357	P230000	197	P239236	72	P28503	467	P307035	154
P22844	357	P23003	505	P239336	72	P28504	467	P307040	154
P22845	357	P23004	505	P239436	77	P28505	467	P307045	154
P22850	354	P23008	505	P239536	77	P28506	467	P307050	154
P22851	354	P23009	505	P239990	351	P28600	466	P307060	154
P22852	354	P230101	154	P23991	351	P28610	466	P307070	154
P22860	374	P230101	194	P23992	351	P28620	466	P307125	154
P22861	374	P23015	505	P23993	351	P28621	466	P307130	154
P22862	374	P230201	194	P240040	51	P29600	465	P307140	154
P22863	374	P230202	196	P240050	51	P2960001	28	P307150	154
P22864	374	P23030	377	P240401	194	P29610	465	P308030	117
P22865	374	P23031	377	P240651	194	P29620	465	P308035	117
P22866	374	P23032	377	P241001	194	P29630	465	P308040	117
P22867	374	P23033	377	P241040	51	P296415	464	P308045	117
P22868	374	P23034	377	P241050	51	P296430	464	P308050	117
P22869	374	P23036	377	P241501	194	P2965001	465	P309040	88
P22870	374	P23037	377	P242024	51	P296515	464	P309050	88
P22871	374	P23038	377	P242028	51	P296530	464	P309060	88
P22872	374	P23039	377	P242032	51	P296615	464	P310000	493
P22873	374	P23040	377	P242035	51	P296630	464	P311002	492
P22874	374	P230401	194	P243024	51	P296715	464	P311004	493
P22875	374	P230402	196	P243028	51	P296730	464	P311006	492
P22876	374	P23042	377	P243032	51	P29680	465	P311020	493
P22877	374	P23043	377	P243035	51	P300024	117	P311071	492
P22878	374	P23044	377	P244024	52	P300030	117	P312000	493
P22879	374	P23045	377	P244028	52	P300325	117	P313025	118
P22880	374	P23046	377	P244032	52	P300335	117	P313030	118
P22881	374	P230651	194	P244035	52	P300340	117	P313126	118
P22882	374	P230652	196	P24407	456	P30084	239	P313132	118
P22883	374	P231001	194	P24409	456	P30084F1	239	P314110	99
P22884	349	P231002	196	P24410	456	P301108	98	P314112	99
P22884A	358	P231501	194	P24411	456	P301109	98	P314210	99
P22884B	358	P231502	196	P24412	457	P301110	98	P314212	99
P22884G	358	P232001	194	P24413	457	P301112	98	P314300	99
P22884N	358	P232002	196	P24414	457	P301114	98	P315010	99
P22884NE	358	P234020	50	P24415	457	P301116	98	P315012	99
P22884R	358	P234024	50	P24704	455	P301118	98	P315015	99

Numerical index

Índice numérico
Index numérique

REF.	PAG.	REF.	PAG.	REF.	PAG.	REF.	PAG.	REF.	PAG.
P315017	99	P325018	115	P350435	161	P373024	115	P41006	479
P315020	99	P325020	115	P350440	161	P373028	115	P41007	479
P316025	156	P326000	492	P350530	161	P374013	115	P41008	462
P316030	156	P327000	493	P350535	161	P374015	115	P41009	462
P316035	156	P328020	120	P350630	161	P374018	115	P41010	462
P316040	156	P328023	120	P350635	161	P374020	115	P41011	462
P316045	156	P328600	120	P350730	161	P374026	115	P41012	479
P316050	156	P330035	496	P350735	161	P375010	114	P41013	479
P316125	156	P330050	496	P351000	448	P375030	115	P41014	479
P316130	156	P330070	496	P352000	448	P375035	115	P41015	479
P316135	156	P331039	152	P353000	448	P375061	114	P41016	479
P316140	156	P331044	152	P354025	156	P375070	114	P41017	479
P316145	156	P331050	152	P354030	156	P375110	114	P41018	479
P316150	156	P331056	152	P354035	156	P376037	100	P41019	479
P317025	438	P331059	152	P354040	156	P376137	100	P41020	479
P317030	438	P331066	152	P354045	156	P377037	100	P44073	240
P317035	438	P331070	152	P354050	156	P377137	101	P44073F1	240
P317040	438	P332010	153	P355007	169	P379065	431	P454012	53
P317045	438	P332095	153	P355008	169	P379500	431	P454014	53
P317045	438	P333010	479	P355009	169	P380000	113	P454016	53
P317100B	389	P333020	479	P356020	155	P381008	113	P454018	53
P317100G	389	P333035	479	P356024	155	P381010	113	P456016	53
P317100S	389	P334050	124	P356028	155	P382000	113	P456020	53
P317200B	389	P334100	124	P356032	155	P383000	113	P456024	53
P317200G	389	P335002	508	P357000	483	P384000	113	P456028	53
P317200S	389	P33621	445	P358024	108	P385020	112	P457016	53
P317300B	389	P33622	445	P358029	108	P385026	112	P457020	53
P317300G	389	P33623	445	P358040	108	P385030	112	P457024	53
P317300S	389	P33624	445	P358230	447	P385500	114	P457028	53
P317400B	389	P33625	445	P358231	447	P386000	113	P458024	53
P317400G	389	P337030	507	P358232	447	P387065	431	P458028	53
P317400S	389	P337060	507	P358237	447	P387100	432	P459018	72
P317425	438	P337090	507	P358241	108	P387200	432	P459020	72
P317430	438	P337150	507	P358242	108	P387500	430	P459024	72
P317435	438	P337200	507	P358243	108	P388018	497	P459028	72
P317440	438	P33801	446	P358244	108	P389000	449	P459032	72
P317445	438	P33802	446	P358245	108	P390000	138	P460018	76
P317450	438	P33803	446	P358246	108	P390100	138	P460020	76
P317500B	388	P33804	446	P358247	108	P391000	120	P460024	76
P317500G	388	P33805	446	P358301	108	P392065	98	P460026	76
P317500S	388	P33806	446	P358302	108	P393080	156	P460028	76
P318005	89	P33807	446	P358303	108	P393100	156	P460030	76
P318040	90	P33808	446	P358304	108	P393125	156	P460032	76
P318060	90	P33809	446	P358305	108	P394008	100	P490014A	55
P318100	497	P340000	222	P358306	108	P394012	100	P490014G	55
P318211	89	P341000	443	P358307	108	P395038	101	P490014N	55
P319000	497	P342000	443	P358404	108	P397247	101	P490014R	55
P319100	497	P343000	443	P358407	108	P397347	101	P490016A	55
P320083	239	P343400	107	P359000	448	P398024	157	P490016G	55
P32083F1	239	P343600	107	P361000	441	P398035	157	P490016N	55
P322101	121	P343700	107	P361100	442	P398042	157	P490016R	55
P322102	121	P343800	107	P362000	441	P398125	157	P490220A	71
P322103	121	P344000	443	P362100	442	P398135	157	P490220G	71
P322104	121	P345000	443	P363000	441	P398140	157	P490220N	71
P322201	121	P347020	116	P363100	442	P398225	157	P490220R	71
P322202	121	P347024	116	P364000	441	P398235	157	P490224A	71
P322203	121	P348008							

Numerical index

Índice numérico
Index numérique

REF.	PAG.	REF.	PAG.	REF.	PAG.	REF.	PAG.	REF.	PAG.
P490624A	55	P5090E5F1	235	P590008	395	P619002	501	P646310	509
P490624G	55	P5090F1	234	P590009	395	P620001	111	P646400	509
P490624N	55	P5091	230	P590010	395	P621000	111	P649050	509
P490624R	55	P5091F1	234	P590011	395	P623003	479	P649100	509
P490628A	55	P5160	230	P590012	395	P625000	483	P650000	483
P490628G	55	P5160E1	232	P590110	397	P630010	481	P685004	432
P490628N	55	P5160E1F1	235	P590120	397	P630020	481	P688045	315
P490628R	55	P5160E2	232	P590130	397	P630030	481	P688065	291
P490632A	55	P5160E2F1	235	P590240	397	P630040	481	P688085	294
P490632G	55	P5160E3	232	P591001	471	P63052	240	P688087	294
P490632N	55	P5160E3F1	235	P591002	471	P63052F1	240	P688130	314
P490632R	55	P5160E4	232	P591003	471	P632001	481	P688133	314
P490724A	55	P5160E4F1	235	P591004	471	P632002	481	P688134	314
P490724G	55	P5160E5	232	P591005	471	P632003	481	P688250	316
P490724N	55	P5160E5F1	235	P591006	387	P632004	481	P688251	316
P490724R	55	P5160F1	234	P591007	387	P632005	481	P688260	316
P490728A	55	P5161	230	P595001	387	P632006	481	P688261	316
P490728G	55	P5161F1	234	P595002	387	P632007	481	P688265	315
P490728N	55	P5250	230	P595003	387	P632008	481	P688266	315
P490728R	55	P5250E1	232	P595004	387	P632009	481	P7000	268
P490732A	55	P5250E1F1	235	P595100	391	P632010	481	P7001	268
P490732G	55	P5250E2	232	P595110	391	P632011	481	P7002	268
P490732N	55	P5250E2F1	235	P595111	391	P632012	481	P7003	268
P490732R	55	P5250E3	232	P595120	391	P632013	481	P7004	268
P490928A	55	P5250E3F1	235	P595121	391	P632014	481	P7004R	274
P490928A	400	P5250E4	232	P595130	391	P632015	481	P7005	268
P490928G	55	P5250E4F1	235	P595131	391	P632016	481	P7005R	274
P490928G	400	P5250E5	232	P595200	391	P632017	481	P7006	268
P490928N	55	P5250E5F1	235	P595300	391	P632018	481	P7006R	274
P490928N	400	P5250F1	234	P596110	390	P632019	481	P7007	268
P490928R	55	P5251	230	P596111	390	P632020	481	P7008	268
P490928R	400	P5251F1	234	P596120	390	P632021	481	P7009	268
P490932A	55	P5360	231	P596121	390	P632022	481	P7010	268
P490932A	400	P5360E1	233	P596130	390	P632023	481	P7011	268
P490932G	55	P5360E1F1	235	P596131	390	P632024	481	P7012	268
P490932G	400	P5360E2	233	P597110	392	P632025	481	P7013	268
P490932N	55	P5360E2F1	235	P597120	392	P632026	481	P7014	268
P490932N	400	P5360E3	233	P597130	392	P632027	481	P7015	268
P490932R	55	P5360E3F1	235	P597140	393	P632028	481	P7016	268
P490932R	400	P5360E4	233	P597150	393	P632029	481	P7017	268
P5000	236	P5360E4F1	235	P597160	393	P632030	481	P7018	268
P5001	236	P5360E5	233	P597170	392	P633000	481	P7019	268
P5002	236	P5360E5F1	235	P598001	386	P633002	481	P7020	268
P5003	236	P5360F1	234	P598002	386	P633003	481	P702026	163
P5004	237	P5361	231	P598003	386	P634000	481	P702028	163
P5015	260	P5361F1	234	P598700	396	P635000	484	P7021	268
P5017	260	P5490	231	P598800	396	P636000	484	P7022	268
P5018	237	P5490E1	233	P603012	146	P637000	484	P702230	163
P5019	237	P5490E1F1	235	P603015	146	P637100	484	P7023	268
P501F1	227	P5490E2	233	P604001	146	P638000	483	P7024	268
P501F2	227	P5490E2F1	235	P604002	146	P638003	480	P7025	268
P501F3	227	P5490E3	233	P604500	145	P638004	480	P7026	268
P501F4	227	P5490E3F1	235	P605000	448	P639000	483	P7027	268
P501F5	227	P5490E4	233	P606000	448	P640000	244	P7028	268
P501F6	227	P5490E4F1	235	P607000	95	P641100	244	P7029	268
P5062	236	P5490E5	233	P607100	95	P642000	244	P7030	268
P508015	316	P5490E5F1	235	P609010	147	P643000	244	P703020	164
P5090	230	P5490F1	234	P609200	147	P644200	509	P703024	164
P5090E1	232	P5491	231	P609705	147	P644240	509	P703028	164
P5090E1F1	235	P5491F1	234	P610000	138	P644275	509	P703032	164
P5090E2	232	P590001	396	P611000	147	P646000	495	P7031	268
P5090E2F1	235	P590002	396	P611001	111	P646100	509	P7032	268
P5090E3	232	P590003	396	P615000	449	P646103	509	P7033	268
P5090E3F1	235	P590004	396	P616000	497	P646105	509	P7034	268
P5090E4	232	P590005	396	P617017	448	P646200	509	P7035	268
P5090E4F1	235	P590006	396	P618000	449	P646300	509	P7036	268
P5090E5	232	P590007	359	P619000	501	P646301	509	P7037	268

Numerical index

Índice numérico
Index numérique

REF.	PAG.	REF.	PAG.	REF.	PAG.	REF.	PAG.	REF.	PAG.
P7038	268	P7094	272	P7146R	274	P720010	165	P7258	272
P7039	268	P7095	272	P7147	268	P720012	165	P7259	272
P7040	268	P7096	272	P7147R	274	P7201	270	P7260	272
P704024	163	P7097	272	P7148	268	P7202	270	P7261	272
P704030	163	P7098	272	P7149	268	P7203	270	P7262	272
P7041	268	P7099	272	P7150	268	P7204	270	P7263	272
P7042	268	P7100	272	P715006	165	P7205	270	P7264	272
P7043	268	P710020	164	P7151	268	P7206	270	P7265	272
P7044	268	P710024	164	P7152	268	P7207	270	P7266	272
P7045	268	P710028	164	P7153	268	P7208	270	P7267	272
P7046	268	P7101	272	P7154	268	P7209	270	P7268	272
P7047	270	P7102	272	P7155	268	P7210	270	P7269	272
P7048	270	P710205	316	P7156	268	P721005	165	P7270	272
P7049	270	P710206	316	P7157	268	P721006	165	P7271	272
P7050	270	P7103	272	P7158	268	P721007	165	P7272	272
P705024	94	P7104	272	P7159	268	P721008	165	P7273	272
P705028	94	P7105	272	P7160	268	P721010	165	P7274	272
P705032	94	P7106	272	P7161	268	P7211	270	P7275	272
P7051	270	P7107	272	P7162	268	P7212	270	P7276	272
P7052	270	P7108	272	P7163	268	P7213	270	P7277	272
P7053	270	P7109	272	P7164	268	P7214	270	P7278	272
P7054	270	P7110	272	P7165	268	P7215	270	P7279	272
P7055	270	P711010	164	P7166	268	P7216	270	P7280	272
P7056	270	P711012	164	P7167	268	P7217	270	P7281	272
P7057	270	P711020	164	P7168	268	P7218	270	P7282	269
P7058	270	P711024	164	P7169	268	P7219	270	P7283	269
P7059	270	P711028	164	P7170	268	P7220	270	P7284	269
P7060	270	P711032	164	P717008	165	P722000	165	P7285	269
P706039	163	P7111	272	P717010	165	P7221	270	P7286	269
P7061	270	P7112	272	P7171	268	P7222	270	P7287	269
P7062	270	P7113	272	P7172	268	P7223	270	P7288	269
P7063	270	P7114	272	P7173	268	P7224	270	P7289	269
P7064	270	P7115	272	P7174	268	P7225	270	P7290	269
P7065	270	P7116	272	P7175	268	P7226	270	P7291	269
P7066	270	P7117	272	P7176	268	P7227	270	P7292	269
P7067	270	P7118	272	P7177	268	P7228	270	P7293	269
P7068	270	P7119	272	P7178	268	P7229	270	P7294	269
P7069	270	P7120	272	P7179	268	P7230	270	P7295	269
P7070	270	P712022	164	P7180	268	P723024	164	P7296	269
P707039	163	P7121	272	P718006	165	P723028	164	P7297	269
P7071	270	P7122	272	P718008	165	P7231	270	P7298	269
P7072	270	P7123	272	P718010	165	P7232	270	P7299	269
P7073	270	P7124	272	P718011	165	P7233	270	P7300	269
P7074	270	P7125	272	P7181	268	P7234	270	P7301	269
P7075	270	P7126	272	P7182	268	P7235	272	P7302	269
P7076	270	P7127	272	P7183	268	P7236	272	P7303	269
P7077	270	P7128	272	P7184	268	P7237	272	P7304	269
P7078	270	P7129	272	P7185	268	P7238	272	P7305	269
P7079	270	P7130	272	P7186	268	P7239	272	P7306	269
P7080	270	P713075	165	P7187	268	P7240	272	P7307	269
P708008	164	P7131	272	P7188	270	P7241	272	P7308	269
P708022	164	P7132	272	P7189	270	P7242	272	P7309	269
P708024	164	P7133	272	P7190	270	P7243	272	P7310	269
P7081	270	P7134	272	P7191	270	P7244	272	P7311	269
P7082	270	P7135	272	P7192	270	P7245	272	P7312	269
P7083	270	P7136	272	P7193	270	P7246	272	P7313	269
P7084	270	P7137	272	P7194	270	P7247	272	P7314	269
P7085	270								

Numerical index

Índice numérico
Index numérique

REF.	PAG.	REF.	PAG.	REF.	PAG.	REF.	PAG.	REF.	PAG.
P7324	269	P7388	273	P7455	269	P7522	273	P7590	276
P7325	269	P7389	273	P7456	269	P7523	273	P7591	276
P7326	269	P7390	273	P7457	269	P7524	273	P7592	276
P7327	269	P7391	273	P7458	269	P7525	273	P7593	276
P7328	269	P7392	273	P7459	269	P7526	273	P7594	276
P7329	271	P7393	273	P7460	269	P7527	273	P7595	276
P7330	271	P7394	273	P7461	269	P7528	273	P7596	276
P733000	166	P7395	273	P7462	269	P7529	273	P7597	276
P7331	271	P7396	273	P7463	269	P7530	273	P7598	276
P7332	271	P7397	273	P7464	269	P7531	273	P7599	276
P7333	271	P7398	273	P7465	269	P7532	273	P7603	274
P7334	271	P7399	273	P7466	269	P7533	273	P7604	274
P7335	271	P7400	273	P7467	269	P7534	273	P7605	274
P7336	271	P7401	273	P7468	269	P7535	273	P7606	274
P7337	271	P7402	273	P7469	269	P7536	273	P7607	274
P7338	271	P7403	273	P7470	271	P7537	273	P7608	274
P7339	271	P7404	273	P7471	271	P7538	273	P7609	274
P7340	271	P7405	273	P7472	271	P7539	273	P7610	274
P7341	271	P7406	273	P7473	271	P7540	273	P7611	274
P7342	271	P7407	273	P7474	271	P7541	273	P7612	274
P7343	271	P7408	273	P7475	271	P7542	273	P7613	274
P7344	271	P7409	273	P7476	271	P7543	273	P7614	274
P7345	271	P7410	273	P7477	271	P7544	273	P7615	274
P7346	271	P7411	273	P7478	271	P7545	273	P7616	274
P7347	271	P7412	273	P7479	271	P7546	273	P7617	274
P7348	271	P7413	273	P7480	271	P7547	273	P7618	274
P7349	271	P7414	273	P7481	271	P7548	273	P7628	275
P7350	271	P7415	273	P7482	271	P7549	273	P7629	275
P7351	271	P7416	273	P7483	271	P7550	273	P7630	275
P7352	271	P7417	273	P7484	271	P7551	273	P7631	275
P7353	271	P7418	273	P7485	271	P7552	273	P7632	275
P7354	271	P7419	273	P7486	271	P7553	273	P7633	275
P7355	271	P7420	273	P7487	271	P7554	273	P7634	275
P7356	271	P7421	273	P7488	271	P7555	273	P7635	275
P7357	271	P7422	273	P7489	271	P7556	273	P7636	275
P7358	271	P7423	269	P7490	271	P7557	273	P7637	275
P7359	271	P7424	269	P7491	271	P7558	273	P7638	275
P7360	271	P7425	269	P7492	271	P7559	273	P7639	275
P736030	94	P7426	269	P7493	271	P7560	273	P7640	275
P736034	94	P7427	269	P7494	271	P7561	273	P764008	155
P7361	271	P7428	269	P7495	271	P7562	273	P764010	155
P7362	271	P7429	269	P7496	271	P7563	273	P764012	155
P7363	271	P7430	269	P7497	271	P7565	277	P7641	275
P7364	271	P7431	269	P7498	271	P7566	277	P7642	275
P7365	271	P7432	269	P7499	271	P7567	277	P7643	275
P7366	271	P7433	269	P7500	271	P7568	277	P76430	275
P7367	271	P7434	269	P7501	271	P7569	277	P7646	276
P7368	271	P7435	269	P7502	271	P7570	277	P7647	276
P7369	271	P7436	269	P7503	271	P7571	277	P765020	168
P7370	271	P7437	269	P7504	271	P7572	277	P765024	168
P7371	271	P7438	269	P7505	271	P7573	277	P768006	168
P7372	271	P7439	269	P7506	271	P7574	277	P768008	168
P7373	271	P7440	269	P7507	271	P7575	277	P769008	168
P7374	271	P7441	269	P7508	271	P7576	277	P769010	168
P7375	271	P7442	269	P7509	271	P7577	277	P769018	168
P7376	273	P7443	269	P7510	271	P7578	277	P769020	168
P7377	273	P7444	269	P7511	271	P7579	277	P769022	168
P7378	273	P7445	269	P7512	271	P7580	277	P771025	168
P7379	273	P7446	269	P7513	271	P7581	277	P777540	90
P7380	273	P7447	269	P7514	271	P7582	277	P777548	90
P7381	273	P7448	269	P7515	271	P7583	277	P777560	90
P7382	273	P7449	269	P7516	271	P7584	277	P778040	90
P7383	273	P7450	269	P7517	273	P7585	276	P778048	90
P7384	273	P7451	269	P7518	273	P7586	276	P778060	90
P7385	273	P7452	269	P7519	273	P7587	276	P779017	90
P7386	273	P7453	269	P7520	273	P7588	276	P779021	90
P7387	273	P7454	269	P7521	273	P7589	276	P779026	90

Numerical index

Índice numérico
Index numérique

REF.	PAG.	REF.	PAG.	REF.	PAG.	REF.	PAG.	REF.	PAG.
P779060	90	P80260	246	P80970	251	P846025	146	P85200	27
P780006	167	P80270	246	P81000	320	P846050	146	P85201	28
P780008	167	P80280	246	P810004	171	P846100	146	P85220	27
P780010	167	P80282	247	P810006	171	P846200	146	P85222	28
P781006	167	P80290	246	P810008	171	P846300	146	P85223	28
P781008	167	P80300	246	P810010	171	P848008	160	P85230	33
P781010	167	P803000	159	P810012	171	P848014	160	P85231	33
P782008	167	P80310	246	P810014	171	P849000	170	P85232	33
P782010	167	P80320	246	P81010	320	P850000	34	P853004	174
P782012	167	P80330	248	P81020	320	P850001	183	P853006	174
P782014	167	P80340	248	P811004	171	P850002	183	P853008	174
P782016	167	P80350	248	P811006	171	P850003	183	P853010	174
P782018	167	P80360	248	P811008	171	P850004	183	P853012	174
P782020	167	P80374	246	P811010	171	P850005	183	P853014	174
P782022	167	P80380	258	P811012	171	P850006	183	P854006	174
P782024	167	P80390	258	P811014	171	P850007	183	P854008	174
P782026	167	P804000	159	P811016	171	P850012	183	P854010	174
P782028	167	P80430	250	P812003	171	P850017	183	P854012	174
P782075	167	P80440	252	P812005	171	P850018	183	P854014	174
P783006	167	P80460	253	P812007	171	P850022	183	P854016	174
P783008	167	P80470	251	P812009	171	P850023	183	P855000	174
P783010	167	P80480	252	P812011	171	P850024	183	P856000	174
P783012	167	P80500	253	P813016	171	P850025	183	P857000	174
P783014	167	P805000	158	P813020	171	P850026	183	P859101	177
P783016	167	P80510	252	P814000	172	P850027	183	P859102	177
P783018	167	P80520	251	P815006	172	P850028	183	P859103	177
P783020	167	P80540	258	P815009	172	P850031	183	P859104	177
P783022	167	P80550	258	P815012	172	P850033	183	P859105	177
P783024	167	P80560	258	P815015	172	P850101	34	P859106	179
P783026	167	P80570	259	P816011	171	P850102	34	P859107	179
P783028	167	P80580	259	P817005	171	P850104	34	P859109	177
P783030	167	P80590	259	P817006	171	P850124	182	P859110	177
P784020	169	P80610	250	P817008	171	P850128	182	P859111	177
P784025	169	P80620	250	P818000	124	P850222	182	P859113	176
P784030	169	P80630	250	P820000	172	P850424	182	P859114	178
P784035	169	P80641	250	P821000	172	P850426	182	P859115	176
P784040	169	P80670	250	P822000	173	P85050B	29	P859116	180
P785006	167	P80680	246	P823000	173	P85050CP	30	P859117	180
P785008	167	P80700	223	P824000	173	P85050R	29	P859119	181
P785010	167	P807000	158	P830001	162	P85050SS	29	P859120	181
P788025	169	P80710	223	P830002	162	P850528	182	P859122	178
P788050	169	P80720	223	P830003	162	P85090B	29	P859123	178
P789025	169	P80730	223	P830004	162	P85090CP	30	P859124	178
P789050	169	P80740	258	P830005	162	P85090MP	31	P859125	178
P796000	166	P80750	259	P833001	95	P85090MPR	31	P859126	178
P796100	166	P80760	259	P833002	95	P85090MT	31	P859129	180
P798040	170	P80770	259	P833003	95	P85090MTR	31	P859130	178
P798055	170	P80780	258	P834000	397	P85090R	29	P859132	176
P798056	170	P80790	257	P835000	397	P85090SS	29	P859134	176
P798065	170	P80810	254	P836110	160	P851001	30	P859135	176
P800030	170	P80811	254	P836120	160	P851002	30	P859139	176
P800035	170	P80813	254	P836147	160	P851003	30	P859141	176
P800040	170	P80814	254	P836200	160	P851004	35	P859142	176
P800045	170	P80840	253	P836215	160	P851005	35	P859143	176
P800050	170	P80850	253	P837003	161	P851006	35	P859144	177
P800055	170	P80870	253	P837005	161	P851007	35	P859150	177
P800060	170	P80880	253	P837007	161	P851040	170	P859151	177
P800065	170	P80900	245	P839000	158	P851046	170	P859152	177
P800070	170	P80910	256	P840000	158	P851050	170	P859153	

Numerical index

Índice numérico
Index numérique

REF.	PAG.	REF.	PAG.	REF.	PAG.	REF.	PAG.	REF.	PAG.
P859172	178	P882035	505	P904350	418	P911201	141	P921001	221
P859184	178	P882100	505	P904400	423	P911202	141	P922000	221
P859185	178	P885025	504	P904500	423	P911301	141	P922100	221
P859186	179	P885040	504	P904600	420	P911302	141	P923000	221
P859189	179	P885060	504	P904610	421	P911303	141	P923001	221
P859190	179	P886035	504	P904612	421	P911304	141	P924001	221
P859191	179	P887015	504	P904650	421	P911305	141	P924002	221
P859192	179	P887025	504	P904652	421	P911306	141	P924002A	221
P859195	179	P887060	504	P904660	420	P911401	141	P924002R	221
P859196	179	P887100	504	P904680	421	P911402	141	P924002V	221
P859197	179	P890025	503	P904682	421	P911403	141	P925001	256
P859198	179	P890035	503	P904711	420	P911404	141	P925002	256
P859200	180	P890060	503	P904720	419	P911405	141	P926002	478
P859201	180	P891035	503	P904721	419	P911406	141	P926003	478
P859202	181	P891060	503	P904725	419	P911407	142	P926004	478
P859203	181	P891100	503	P904740	420	P911408	141	P926005	478
P859204	181	P892015	503	P904760	420	P911501	142	P926006	478
P859205	181	P892015B	502	P904780	420	P911502	142	P926007	478
P859206	180	P892015N	502	P904790	417	P911503	142	P926008	478
P859207	180	P892015R	502	P904804	418	P911504	142	P926009	478
P859210	180	P892025	503	P904809	418	P911505	142	P926010	478
P859211	180	P892035	503	P904810	418	P911506	142	P926011	478
P859212	180	P892035B	502	P904820	418	P911507	142	P926012	478
P859219	178	P892035N	502	P904850	418	P911508	142	P926051	478
P859900	184	P892035R	502	P90490	425	P911601	142	P926052	478
P859901	184	P892060	503	P90492	425	P911602	142	P926053	478
P859902	184	P892060B	502	P90493	425	P911603	142	P926300	464
P859903	184	P892060N	502	P904937	421	P911604	142	P926400	464
P859904	184	P892060R	502	P904950	421	P911605	142	P926500	464
P859905	184	P892100	503	P904975	421	P911606	142	P926600	464
P859907	185	P892150	503	P904980	421	P911607	142	P927000	439
P859908	185	P892200	503	P904990	421	P911608	142	P928000	439
P859909	185	P893025	503	P905015	119	P911701	141	P928001	439
P859910	185	P893035	503	P905300	416	P911801	141	P929025	94
P859911	185	P894003	506	P905310	417	P911802	141	P929028	94
P861045	222	P894004	506	P905320	417	P911803	141	P929030	94
P861053	222	P894005	506	P905340	417	P911804	141	P929036	94
P862100	482	P895006	507	P905400	416	P911805	141	P929040	94
P863000	482	P895010	507	P905410	416	P911806	141	P937000	135
P867030	380	P895015	507	P905504	415	P911808	141	P938000	138
P867060	380	P895020	507	P905506	415	P911901	142	P940000	124
P867090	380	P896001	506	P905508	415	P911902	142	P940090	124
P867120	380	P896002	506	P905516	415	P911903	142	P940120	124
P868001	122	P896003	505	P905518	416	P911904	142	P941013	100
P868002	122	P896008	505	P907024	439	P911905	142	P941015	100
P868003	122	P897500	430	P907026	439	P911906	142	P941018	100
P868004	122	P898001	507	P908000	152	P911908	142	P941020	100
P868005	122	P898002	507	P908001	152	P912001	141	P941022	100
P868006	122	P899200	435	P908002	152	P913000	142	P941024	100
P868007	122	P899300	435	P908003	152	P913501	142	P941028	100
P868008	122	P900000	223	P908004	152	P913601	142	P942000	119
P868009	122	P901014	142	P90813	427	P913701	142	P943000	119
P870000	119	P901018	142	P908132	427	P913901	142	P944000	124
P871000	119	P902000	449	P90814	427	P914080	153	P945037	118
P872000	114	P903001	433	P908142	427	P914120	153	P945050	118
P872500	160	P903002	433	P90910	489	P914150	153	P945051	118
P873045	124	P904113	423	P90911	489	P915080	153	P946001	123
P873060	124	P904120	423	P909111	92	P916000	153	P946002	123
P873090	124	P904140	423	P909121	92	P916120	153	P946003	123
P874000	482	P904142	423	P909211	92	P917080	153	P946004	123
P876001	470	P904145	423	P909221	92	P919000	220	P947302	149
P876002	470	P904146	423	P90930	490	P919001	220	P947303	149
P876003	470	P904155	418	P909340	92	P919002	220	P947400	149
P880035	505	P904160	423	P909360	92	P919003	220	P947600	149
P880050	505	P904165	423	P909460	92	P920001	221	P947700	149
P881100	505	P904200	423	P909559	162	P920002	221	P948066	95
P882015	505	P904300	397	P910008	314	P920003	221	P948090	95

Numerical index

Índice numérico
Index numérique

REF.	PAG.	REF.	PAG.	REF.	PAG.	REF.	PAG.	REF.	PAG.
P948132	95	P968135	35	P995016	84	PC15PHC	93	TRJ	230
P949025	94	P968135	482	P995016	458	PC15PN	93	TRM	231
P949030	94	P969000	482	P995020	84	PC15SCC	93	VCBL100	217
P949035	94	P970000	116	P995026	84	PC15SN	93	VCBM100	217
P949040	94	P972053	95	P995030	84	PC16FPHC	93	VDBBM300	219
P950000	318	P972060	95	P995034	84	PC16PN	93	VDBBM50002	219
P950000	432	P972201	491	P995036	84	PC16SHC	93	VPB116	215
P951010	155	P972202	491	P995038	84	PC18FPHC	93	VPB118	215
P951015	155	P972203	491	P995040	84	PC18PCC	93	VTB300	219
P951019	155	P974000	493	P995042	84	PC18PN	93	VTB50002	219
P951024	155	P975000	131	P995050	84	PC18SCC	93	VTBWR-1	219
P952001	155	P975501	139	P995060	84	PC18SN	93	XMIX0702	302
P952002	155	P975600	139	P997014	84	PLC-1	513	XMIX0703	302
P952003	155	P975900	137	P997014	458	PLC-2	513	XMIX0704	302
P953001	155	P976200	492	P997016	84	PLC-3	513	XMIX0705	302
P953002	155	P976210	491	P997016	458	RE8505004	30		
P953003	155	P976300	492	P997028	84	RE8509007	30		
P953004	155	P979000	160	P997032	84	RE851008	35		
P953005	155	P979100	160	P997036	84	RE8514007	30		
P954013	118	P979200	160	P997040	84	RE937001	135		
P954015	118	P980000	148	P998010	458	RE937002	135		
P954020	118	P980050	148	P998012	458	RE937003	135		
P954025	118	P980200	147	P998014	458	RE940001	124		
P955010	100	P980400	147	P998035	85	RE964100	138		
P955012	100	P981500	148	P998050	85	RE964200	138		
P955015	100	P981600	148	P998070	85	RE975001	131		
P955017	100	P981650	148	P999000	85	RE975002	131		
P955020	100	P983000	500	P999012	458	RE975901	137		
P956035	501	P984100	500	P999014	458	RSCL-4	513		
P956040	501	P984500	500	PC07PCC	93	S1	511		
P956135	501	P985000	500	PC07PHC	93	SAC-SQ5-06	261		
P956140	501	P988100	495	PC07SCC	93	SAVC	261		
P958010	118	P988200	495	PC07SHC	93	SO2-23010.5	298		
P958012	118	P988300	495	PC07SN	93	SO2-23014.5	298		
P958014	118	P988400	494	PC08PCC	93	T3660	435		
P958016	118	P988500	494	PC08PN	93	T7206	152		
P958018	118	P988600	494	PC08SHC	93	TR11	230		
P959025	156	P988700	494	PC08SN	93	TR11G	232		
P959030	156	P988900	495	PC09SCC	93	TR11GG	232		
P959035	156	P990000	495	PC09SHC	93	TR11GGG	232		
P959040	156	P99001	213	PC10FPHC	93	TR11GGGG	232		
P959045	156	P99020	214	PC10PCC	93	TR11GGGGG	232		
P959050	156	P99021	214	PC10PN	93	TR12	231		
P960225	157	P99030	216	PC10SCC	93	TR12H	233		
P960230	157	P99031	216	PC10SHC	93	TR12HH	233		
P960235	157	P992040	168	PC10SN	93	TR12HHH	233		
P962002	432	P992045	168	PC11PCC	93	TR12HHHH	233		
P962003	432	P992050	168	PC11PHC	93	TR12HHHHH	233		
P963025	94	P994020	84	PC11PN	93	TR13	231		
P963030	94	P994022	84	PC11SHC	93	TR13M	233		
P963035	94	P994024	84	PC11SN	93	TR13MM	233		
P963040	94	P994026	84	PC12FPHC	93	TR13MMM	233		
P964001	138	P994030	84	PC12PCC	93	TR13MMMM	233		
P967001	481	P994032	84	PC12PHC	93	TR18	230		
P967002	481	P994034	84	PC12PN	93	TR18J	232		
P967003	481	P994036	84	PC12SCC	93	TR18JJ	232		
P967004	481	P994038	84	PC12SN	93	TR18JJJ	232		
P967005	481	P994040	84	PC13PCC	93	TR18JJJJ	232		
P967006	481	P994042							

1. GOVERNING PROVISIONS

All sales by PUJADAS – A Vollrath Company (“Seller”) are subject to these terms and conditions, and are expressly conditioned upon assent to these terms and conditions. No additional or different terms or conditions will be binding upon Seller unless specifically agreed to in writing. Seller hereby objects to any such additional or different terms, and notifies buyer that Seller is unwilling to sell on any terms other than these terms and conditions. **Each contract of sale, including these terms and conditions shall constitute the entire agreement between Seller and buyer, and shall be governed by, construed and interpreted according to the laws of Spain, without reference to Principles of Conflicts of Laws. The rights and obligations of the Parties hereunder shall not be governed by the 1980 U.N. Convention on Contracts for the International Sale of Goods; and both parties hereby expressly submit to the jurisdiction of the Courts of Barcelona (Spain), in respect of any proceedings arising out of or in connection with the present General Selling Conditions.** There are no conditions affecting the parties’ agreement which are not expressed in these terms and conditions.

2. TAXES AND OTHER CHARGES

Any manufacturer's tax, occupation tax, use tax, sales tax, excise tax, value added tax, duty, custom, inspection or testing fee, or any other tax, fee, interest or charge of any nature whatsoever imposed by any governmental authority on or measured by the transaction between Seller and buyer shall be paid by buyer in addition to the prices quoted or invoiced. In the event Seller is required to pay any such taxes or other charges, buyer shall reimburse Seller therefore on demand.

3. DELIVERY AND FREIGHT

All items are delivered FCA point of origin (Incoterms 2020). Except as provided below, orders made from the area of the Peninsula and the Balearic Islands with a value over 500 € (1,600 € in Canary Islands) shipping to one location will be shipped PREPAID by Seller. Orders with a value below 500 € will be assessed a 20 € freight charge. (60 € in Canary Islands). For ultimate destinations outside of Spain, all items are FCA Seller's loading dock (as the latter shipping term is defined in Incoterms 2020). Delivery of products to the carrier shall constitute delivery to buyer; and regardless of shipping terms or freight payment, buyer shall bear all risk of loss or damage in transit. Seller reserves the right to make delivery in multiple shipments, unless otherwise expressly stipulated herein; all such shipments to be separately invoiced and paid for when due per invoice, without regard to subsequent deliveries.

Seller reserves ownership rights over all the materials supplied until full payment of the same.

a. Minimum Order Amount and Drop Ship Orders

A 6 € minimum order charge will apply to orders less than One Hundred Euro (100 €) NET. Seller reserves the right to refuse requests to drop ship orders for the same products to one or multiple locations.

b. Quantity

The materials will be supplied in complete packaging containing the quantity indicated in our rates.

c. Custom Smallwares

Custom Smallwares orders are completed with over/under shipments, not to exceed plus or minus 10% of the original order quantity.

4. CLAIMS, DELAYS AND FORCE MAJEURE

Under no circumstances shall claims concerning the condition of the merchandise or regarding shipping mistakes be accepted once 15 workdays have elapsed since the reception thereof.

Claims for shortages or other errors in delivery must be made in writing to Seller within 15 working days after receipt of shipment; and failure to give such notice shall constitute unqualified acceptance and a waiver of all such claims by buyer. **Claims for loss of or damage to goods in transit must be made to the carrier, and not to Seller. OUR RESPONSIBILITY FOR SHIPMENT CEASES WITH ACCEPTANCE BY CARRIERS.**

All delivery dates are approximate. Delay in delivery of any shipment shall not relieve buyer of its obligations to accept remaining shipments. Further, Seller shall not be liable for any losses or damages as a result of any delay or failure to deliver due to any cause beyond Seller's reasonable control, including but not limited to any act of God, act of buyer, arrest or other governmental act, regulation or request, fire, accident, strike, slowdown, war, act of terrorism, riot, delay in transportation, or inability to obtain necessary labor, materials or manufacturing facilities. In the event of any such delay, the date of delivery shall be extended for a period equal to the time lost because of the delay. Buyer's exclusive remedy for other delays and for Seller's inability to deliver for any reason shall be rescission of its agreement to purchase.

5. CHANGES

Seller may at any time make such changes in design and construction of products, components or parts as Seller deems appropriate, without notice to buyer. Seller may furnish suitable substitutes for materials unobtainable because of priorities or regulations established by governmental authority or non-availability of materials from suppliers.

6. WARRANTIES

Seller warrants any smallwares provided hereunder to be free from nonconformity to any attached specifications, and free of defects in materials and workmanship, appearing within 60 days. Seller also warrants any equipment provided hereunder to be free from nonconformity to any attached specifications, and free of defects in materials and workmanship, appearing within 18 months from date of shipment or 12 months from date of purchase by the end user, whichever ends earlier. If within such periods any such applicable goods shall be proved to Seller's satisfaction to be defective, the affected part will be repaired or replaced free of charge, FCA buyer's original destination, or Seller will refund the purchase price of the affected part. Such repair, replacement or refund (whichever Seller determines, in its discretion, to provide) shall be Seller's sole obligation and buyer's exclusive remedy for any deficiency in goods furnished hereunder, and shall be conditioned upon buyer's return of such goods to Seller, .. DDP Seller's loading dock (as the latter shipping term is defined in Incoterms 2020). Any parts repaired or replaced under this warranty are warranted only for the balance of the warranty period on the part that was repaired or replaced. Seller gives no warranty on any goods damaged by accident, carelessness, improper installation, lack of proper setup or supervision (when required) or installed or operated in any manner contrary to the installation and operating instructions. Seller gives no warranty on any repair services performed by unauthorized personnel or unauthorized service agencies.

THE ABOVE WARRANTIES ARE EXCLUSIVE AND IN LIEU OF ALL OTHER REPRESENTATIONS AND WARRANTIES, EXPRESS OR IMPLIED; AND SELLER EXPRESSLY DISCLAIMS AND EXCLUDES ANY IMPLIED WARRANTY OF MERCHANTABILITY OR FITNESS FOR ANY PARTICULAR PURPOSE, AND ANY WARRANTIES ARISING FROM COURSE OF DEALING OR USAGE OF TRADE.

7. CANCELLATIONS AND RETURNS.

No order may be cancelled or altered by buyer except upon terms and conditions acceptable to Seller, as evidenced by Seller's written consent.

Return Authorizations must be requested for all returns. Product returned without prior authorization from Seller's Santa Coloma de Farners office **WILL BE REFUSED.** PUJADAS if free to authorize the return and can decide refuse the return by its free criterion.

a. Requests for returns of merchandise (other than defective merchandise) must be made within **90 DAYS of the PUJADAS INVOICE DATE. PURCHASE ORDER NUMBER or PUJADAS INVOICE NUMBER MUST BE PROVIDED when requesting the authorization. NO RETURN AUTHORIZATION will be issued unless Purchase Order Number or PUJADAS Invoice Number is provided.**

b. **A restocking charge applies as follows:**

1. Merchandise less than 50 € value – 10 € restocking charge.
2. **Merchandise more than 50 € value - 20% restocking charge.**

c. The returns or shipments of materials to the facilities of PUJADAS whether for payment, replacement or repair should always be made **by prepaid freight.**

d. Return Authorization Number must be marked on all returned cartons.

e. **Returns accepted only on current merchandise found in original carton and in new and saleable condition. Merchandise returned that is used, obsolete or shelf-worn will be disposed of and credit WILL NOT be issued.**

1. The return of SHELVING shall only be performed in complete & original packaging, on pallets if it is more than one packaging and properly protected.

2. The return of TROLLEYS shall be made on pallets and with complete protective packaging.

f. The following items may not be returned: (1) custom smallware, (2) Traex dishwasher racks, (3) personalized items.

Neither shall the return of materials be admitted in which PUJADAS has performed some specific adaptation to comply with the order.

8. PATENTS, TRADEMARKS AND COPYRIGHTS

Seller will, at its own expense, defend any suits that may be instituted by anyone against buyer for alleged infringement of any European Union patent, trademark or copyright relating to goods or services provided by Seller, and pay any final damage award therein, provided buyer shall have made all payments then due hereunder, shall give Seller immediate notice in writing of any such suit, shall transmit to Seller immediately upon receipt all processes and papers served upon buyer, and shall permit Seller, through its counsel, to defend or settle the same either in the name of buyer or in the name of Seller, giving Seller all needed information, assistance and authority to enable Seller to do so. Further, if the result of any such suit is a determination or acknowledgement of infringement, Seller shall, at Seller's option (a) obtain for buyer the right to continue to use the goods or products of the services purchased from Seller, or (b) replace the same with non-infringing goods or services, or (c) modify such goods or services so that they are non-infringing, or (d) remove such goods or products of services and refund to buyer the undepreciated portion of the purchase price, determined on the basis of a five-year useful life.

To the extent that any goods or services that Seller furnishes to buyer are manufactured in accordance with drawings, designs or specifications proposed or furnished by buyer, Seller shall not be liable, and buyer shall indemnify and hold harmless Seller from and against any and all losses, liabilities, damages, claims and expenses (including but not limited to Seller's reasonable attorneys' fees and other costs of defense) incurred by Seller as a result of any claim of patent, trademark, copyright or trade secret infringement, or infringement or any other proprietary rights of third parties.

9. CONSEQUENTIAL DAMAGES AND OTHER LIABILITY; INDEMNITY

Seller's liability with respect to the goods or services sold hereunder shall be limited to the warranty and indemnity provided in sections 7 and 9 of these terms and conditions of sale and, with respect to any other breaches of its contract with buyer, shall be limited to the contract price. **SELLER SHALL NOT BE SUBJECT TO ANY OTHER OBLIGATIONS OR LIABILITIES, WHETHER ARISING OUT OF BREACH OF CONTRACT, WARRANTY, TORT (INCLUDING NEGLIGENCE AND STRICT LIABILITY) OR UNDER OTHER THEORIES OF LAW OR EQUITY, WITH RESPECT TO GOODS OR SERVICES SOLD BY SELLER, OR ANY UNDERTAKINGS, ACTS OR OMISSIONS RELATING THERETO.** Without limiting the generality of the foregoing, Seller specifically disclaims any liability for property damages, penalties, special or punitive damages, damages for lost profits or revenues, down-time, lost good will, cost of capital, cost of substitute goods or services, or for any other types of loss of economic advantage, or for claims of buyer's customers or any third party for any such damages, costs or losses.

SELLER SHALL NOT BE LIABLE FOR AND DISCLAIMS ALL CONSEQUENTIAL, INCIDENTAL, INDIRECT AND CONTINGENT DAMAGES WHATSOEVER.

Buyer shall indemnify and hold harmless Seller from and against any and all losses, liabilities, damages and expenses (including but not limited to attorneys' fees and other costs of defense) that Seller may incur as a result of any claim by buyer or by buyer's customers or by any third party arising out of or in connection with the goods or services sold hereunder, , unless such losses, liabilities, damages or expenses are ultimately determined to be attributable solely to the willful misconduct of Seller.

10. PRICES

The selling prices are those specified in our rates, in reference to the merchandise in our warehouse of Santa Coloma de Farners with non-returnable cardboard packaging.

11. PHOTOS, DATA AND MEASUREMENTS

The photos, **data and measurements in the Seller's catalogue are subject to change**, without prior notice, due to technical or production requirements.

12. PERSONAL DATA PROTECTION

In accordance with the provisions of current legislation on the Protection of Personal Data, VOLLRATH PUJADAS, S.A.U informs the buyer that the personal data collected during the commercial relationship will be processed and incorporated into the seller's files, with the aim of being able to provide the services requested, as well as to keep the buyer informed of new products and services. The data provided will be kept as long as the commercial relationship is maintained and, once it has ended, to meet those requests required under tax legislation. The buyer may, at any time, exercise the rights of access, rectification or erasure, restriction of processing, data portability and opposition by means of a written request to info@pujadas.es, accompanied by a photocopy of your DNI/NIF (National Identity Document/Tax Identification Number). You can also contact the competent Control Authority to submit any complaint that you consider appropriate.

All rights reserved to make changes, without prior notice to articles that appear in this catalogue, particularly in relation to colours and/or prices.

Photographs do not form part of the contract.

1. DISPOSICIONES LEGALES

Todas las ventas realizadas por PUJADAS – Una compañía del grupo Vollrath (en adelante, “el vendedor”) están sujetas a los presentes términos y condiciones, y están expresamente condicionadas por la aceptación de los presentes términos y condiciones. Ningún otro término o condición adicional o diferente será vinculante para el vendedor a menos que se acuerde lo contrario específicamente por escrito. Por el presente el vendedor no acepta otros términos adicionales o diferentes y notifica al comprador que no está dispuesto a vender en virtud de términos diferentes de los presentes términos y condiciones. **Cada contrato de venta, incluyendo los presentes términos y condiciones, constituirá el acuerdo indivisible entre el vendedor y el comprador, y se regirá, interpretará y entenderá según las leyes de España, sin remisión a los Principios sobre Conflictos de Leyes. Los derechos y las obligaciones de las partes en virtud del presente no se regirán por la Convención de las Naciones Unidas sobre los Contratos de Compraventa Internacional de Mercaderías de 1980; y por el presente ambas partes se someten expresamente a la jurisdicción de los tribunales de Barcelona (España), para cualquier proceso judicial que surja de las presentes condiciones generales de venta o relacionado con estas.** No existe ninguna condición que afecte al acuerdo de las partes que no esté expresada en los presentes términos y condiciones.

2. IMPUESTOS Y OTROS CARGOS

Los impuestos del fabricante, impuesto por ocupación, impuesto por el uso, impuesto sobre las ventas, impuesto sobre consumos específicos, impuesto sobre el valor añadido, tasas, tarifas de personalización, inspección o prueba, o cualquier otro impuesto, tasa, interés o cargo de cualquier naturaleza impuesto por una autoridad gubernamental, en virtud de la transacción entre el comprador y el vendedor serán pagados por el comprador, además de los precios cotizados o facturados. Si el vendedor debiera pagar dichos impuestos u otros cargos, el comprador deberá reembolsarlos al vendedor.

3. ENTREGA Y FLETE

Todos los productos se entregarán bajo FCA punto de origen (Incoterms 2020). Con la excepción de lo establecido a continuación, los pedidos realizados desde la zona de la Península Ibérica y las Islas Baleares con un valor superior a 500 € (1.600 € en las Islas Canarias) con envío a un único destino se enviarán PREPAGADOS por el vendedor. Los pedidos con un valor inferior a 500 € (Base Imponible) se grabarán con un cargo por flete de 20 € (60 € en las Islas Canarias). Para destinos finales fuera de España, todos los productos estarán sujetos a FCA muelle de carga del vendedor (según la definición de este último en Incoterms 2020). La entrega de los productos al transportista se considerará entrega al comprador; e independientemente de los términos de envío o el pago del flete, el comprador asumirá todos los riesgos por pérdida o daño durante el transporte. El vendedor se reserva el derecho a hacer la entrega en múltiples envíos, a menos que se estipule lo contrario expresamente en el presente; dichos envíos se facturarán por separado y se pagarán en la fecha que indica cada factura, independientemente de las entregas posteriores. El vendedor se reserva los derechos de propiedad de todos los materiales enviados hasta el pago completo de estos.

a. Gestión por pedido mínimo

Se aplicará un cargo de 6 € por la gestión de pedidos inferiores a 100 € NETOS. El vendedor se reserva el derecho a no aceptar pedidos de envío directo para los mismos productos a uno o múltiples sitios.

b. Cantidad

Los materiales se enviarán con el embalaje completo que contenga la cantidad indicada en nuestras tarifas.

c. Utensilios de cocina a medida

Los pedidos de utensilios de cocina a medida se ejecutan con entregas parciales/sobreenvíos, sin que la diferencia suponga un 10% más o menos de la cantidad original pedida.

d. Para pedidos Urgentes para todo territorio nacional, incluyendo islas Baleares y Canarias, se les aplicará un cargo de 15€ por pedido.

El envío será por “Transporte Urgente” con compromiso de entrega en 24 horas, a excepción de las Islas Canarias y Baleares. En estos casos, el transporte será a cargo del cliente.

4. RECLAMACIONES, RETRASOS Y FUERZA MAYOR

No se aceptarán bajo ninguna circunstancia reclamaciones relativas al estado de la mercancía o a errores de envío tras 15 días laborables desde la recepción de esta.

Las reclamaciones por falta de materiales u otros errores en la entrega deben efectuarse por escrito ante el vendedor en el plazo de 15 días laborables tras la recepción del envío; y el hecho de no notificar dicha reclamación supone la aceptación absoluta y la renuncia a cualquier reclamación por parte del comprador. **Las reclamaciones por pérdidas o daños en los productos durante el transporte deben efectuarse ante el transportista y no ante el vendedor. NUESTRA RESPONSABILIDAD POR EL ENVÍO FINALIZA CON LA ACEPTACIÓN DE ESTE POR PARTE DE LOS TRANSPORTISTAS.**

Todas las fechas de entrega son aproximadas. El retraso en la entrega de cualquier envío no exime al comprador de su obligación de aceptar los envíos restantes. Además, el vendedor no será responsable por las pérdidas o los daños que resulten de los retrasos o de la falta de entrega por cualquier causa fuera del control razonable del vendedor, incluyendo sin limitación fuerza mayor, actos del comprador, embargo u otro acto, norma o petición gubernamental, incendio, accidente, huelga, parones, guerra, acto de terrorismo, disturbios, retraso en el transporte o incapacidad para conseguir la mano de obra, los materiales o las instalaciones de producción necesarios. En caso de algún retraso de este tipo, la fecha de entrega se ampliará durante un plazo igual al tiempo perdido debido al retraso. El único remedio del comprador por otros retrasos y por la incapacidad del vendedor de efectuar la entrega por cualquier motivo será la rescisión de su contrato de compra.

5. MODIFICACIONES

En cualquier momento, el vendedor podrá realizar modificaciones en el diseño y la construcción de los productos, los componentes o las partes como el vendedor lo crea apropiado, sin previo aviso al comprador. El vendedor puede ofrecer sustitutos apropiados del material no disponible debido a las prioridades o normas establecidas por la autoridad gubernamental o la falta de materiales por parte de los proveedores.

6. GARANTÍA

El vendedor garantiza que cualquier utensilio de cocina suministrado en virtud del presente está libre de disconformidad con cualquier especificación adjunta y libre de defectos en los materiales y la calidad, que aparezcan en el plazo de 60 días. El vendedor también garantiza que cualquier equipo suministrado en virtud del presente está libre de disconformidad con cualquier especificación adjunta y libre de defectos en los materiales y la calidad, que aparezcan en el plazo de 18 meses desde la fecha de envío o 12 meses desde la fecha de compra por el usuario final, lo que ocurra antes. Si en dichos plazos cualquier producto pertinente se demuestra a satisfacción del vendedor que es defectuoso, la pieza afectada será reparada o sustituida sin cargo, bajo FCA destino original del comprador, o el vendedor devolverá el precio de compra de la parte afectada. La reparación, la sustitución o la devolución (lo que el vendedor determine, a su discreción) constituirá la única obligación del vendedor y el único remedio del comprador para cualquier deficiencia en los productos suministrados en virtud del presente, y estará condicionada por la devolución de dichos productos al vendedor por parte del comprador, bajo DDP muelle de carga del vendedor (según la definición de este último en Incoterms 2020). Cualquier pieza reparada o sustituida en virtud de esta garantía se garantiza solo durante el período restante de garantía sobre la pieza que ha sido reparada o sustituida. El vendedor no garantiza productos que hayan sido dañados por accidente, imprudencia, instalación indebida, configuración o supervisión (cuando proceda) inadecuadas o que hayan sido instalados o puestos en funcionamiento de cualquier modo que sea contrario a las instrucciones de instalación y funcionamiento. El vendedor no garantiza ningún servicio de reparación efectuado por personal no autorizado o agencias de servicios no autorizadas.

LAS GARANTÍAS ANTERIORES SON EXCLUSIVAS Y SUSTITUYEN TODAS LAS OTRAS ASEVERACIONES Y GARANTÍAS, EXPRESAS O IMPLÍCITAS; Y EL VENDEDOR NO ACEPTA Y EXCLUYE EXPRESAMENTE CUALQUIER GARANTÍA IMPLÍCITA DE COMERCIALIZACIÓN O IDONEIDAD PARA CUALQUIER PROPÓSITO PARTICULAR, Y CUALQUIER GARANTÍA QUE PUEDA SURGIR DE UN ACUERDO O USO COMERCIAL.

7. CANCELACIONES Y DEVOLUCIONES

Ningún pedido podrá ser cancelado ni modificado por el comprador excepto en virtud de los términos y condiciones que pueda aceptar el vendedor, tal como lo indique el consentimiento escrito del vendedor. Se solicitará una autorización de devolución para todas las devoluciones. **SE RECHAZARÁN** las devoluciones de productos que no cuenten con la autorización previa por parte de la oficina del vendedor de Santa Coloma de Farners. PUJADAS tiene libertad para autorizar y devolver y puede decidir rechazar la devolución según su propio criterio.

- Las solicitudes de devoluciones de mercancía (que no sea mercancía defectuosa) deben efectuarse en el plazo de **90 DÍAS desde la FECHA DE LA FACTURA DE PUJADAS, DEBE INDICARSE EL NÚMERO DE ORDEN DE COMPRA o EL NÚMERO DE FACTURA DE PUJADAS al solicitar la autorización. NO SE EMITIRÁ NINGUNA AUTORIZACIÓN DE DEVOLUCIÓN a menos que se proporcione el número de orden de compra o el número de factura de Pujadas.**
- Se aplicará un cargo por reposición de existencias como se indica a continuación: Para cualquier devolución se cargará un 20% del importe, por demérito y gestión, con un mínimo de 10 €.**
- Las devoluciones o los envíos de materiales a las instalaciones de PUJADAS para su pago, sustitución o reparación deberán efectuarse **siempre por flete prepago.**
- El número de autorización de la devolución deberá marcarse en todos los embalajes de los productos que se devuelvan.
- Únicamente se aceptarán devoluciones de mercancía actual en su embalaje original, sin usar y en estado vendible. La mercancía devuelta que haya sido usada, esté obsoleta o desgastada se eliminará y NO se emitirá crédito.**
 - La devolución de ESTANTERÍAS solo se efectuará si van en su embalaje completo y original, en palés si constan de más de un bulto y correctamente protegidas.
 - La devolución de CARROS se efectuará en palés y con el embalaje protector completo.
- Los siguientes productos no pueden devolverse: (1) utensilios de cocina a medida, (2) cestas de lavado Traex (3) artículos personalizados. Tampoco se aceptará la devolución de materiales en los que PUJADAS haya efectuado alguna adaptación concreta para satisfacer el pedido.

8. PATENTES, MARCAS COMERCIALES Y COPYRIGHT

El vendedor, únicamente a su cargo, se defenderá de cualquier demanda realizada por cualquier persona contra el comprador por presunta violación de una patente de la Unión Europea, marca comercial o copyright relacionada con los productos o servicios ofrecidos por el vendedor en virtud del presente, y pagará cualquier indemnización por daños que se otorgue en firme, siempre y cuando el comprador haya realizado todos los pagos en virtud del presente y notifique por escrito al vendedor dicha demanda de inmediato, y transmita de inmediato al vendedor todas las notificaciones procesales y documentos recibidos, y permita al vendedor, a través de su abogado, defenderse de esta o resolverla, ya sea en nombre del comprador o del vendedor, y suministre toda la información, asistencia y autoridad necesarias para permitir al vendedor que así lo haga. Además, si el resultado de cualquier demanda es una resolución o un reconocimiento de infracción, el vendedor deberá, a elección del vendedor: (a) obtener para el comprador el derecho de continuar usando los bienes o productos o los servicios adquiridos del comprador, (b) sustituirlos con productos o servicios que no supongan ninguna infracción, (c), modificar dichos productos o servicios de manera que no supongan ninguna infracción, o (d) eliminar dichos bienes o productos o servicios y reembolsar al comprador la parte no devaluada del precio de compra, considerando una vida útil de cinco años.

En cuanto a los productos o servicios que el vendedor suministra al comprador fabricados partiendo de dibujos, diseños o especificaciones propuestas o suministradas por el comprador, el vendedor no será responsable y el comprador deberá indemnizar y eximir de responsabilidad al vendedor ante cualquier pérdida, responsabilidad, daño, reclamación y gasto (incluyendo sin limitación los honorarios razonables de los abogados del vendedor y otros costes de defensa) incurridos por el vendedor como resultado de una demanda por patente, marca comercial, copyright o violación del secreto comercial, o violación de otro derecho sobre la propiedad de terceros.

9. PERJUICIOS Y OTRA RESPONSABILIDAD; INDEMNIZACIÓN

La responsabilidad del vendedor respecto de los productos o servicios que se vendan en virtud del presente se limitará a la garantía y la indemnización establecidas en las secciones 7 y 9 de los presentes términos y condiciones de venta y, respecto de cualquier otro incumplimiento de su contrato con el comprador, se limitará al precio del contrato. **EL VENDEDOR NO ESTARÁ SUJETO A OTRA OBLIGACIÓN O RESPONSABILIDADES, YA SEA QUE SURJAN DE UN INCUMPLIMIENTO DE CONTRATO, GARANTÍA, ILÍCITO CIVIL (INCLUYENDO NEGLIGENCIA Y RESPONSABILIDAD POR HECHOS AJENOS) U OTRAS DOCTRINAS, RESPECTO DE LOS PRODUCTOS O LOS SERVICIOS OFRECIDOS POR EL VENDEDOR, O CUALQUIER EMPRENDIMIENTO, ACCIÓN U OMISIÓN RELACIONADA CON ESTOS.** Sin limitar el carácter general de lo antedicho, el vendedor específicamente rechaza cualquier responsabilidad por daños a la propiedad, multas, daños cuantificables o punitivos, daños por lucro cesante, inactividad, pérdida de clientela, coste de capital, coste de sustitución de productos o servicios, o cualquier otro tipo de pérdida de ventaja económica, o demandas de los clientes del comprador o de cualquier tercero por dichos daños, costes o pérdidas.

EL VENDEDOR NO SERÁ RESPONSABLE Y NO ACEPTA LA RESPONSABILIDAD POR PERJUICIOS, DAÑOS FORTUITOS, INDIRECTOS Y ACCIDENTALES DE CUALQUIER NATURALEZA.

El comprador eximirá y liberará al vendedor de cualquier pérdida, responsabilidad, daños y gastos (incluyendo sin limitación honorarios razonables de abogados y otros costes de defensa) en que pueda incurrir el vendedor como resultado de cualquier demanda del comprador, de los clientes del comprador o de cualquier tercero derivados de los productos y servicios que se vendan en virtud del presente o relacionados con estos, a menos que se determine en última instancia que dichas pérdidas, responsabilidades, daños o gastos son atribuibles únicamente a la conducta premeditada del vendedor.

10. PRECIOS

Los precios de venta son los que se especifican en nuestras tarifas, en referencia a la mercancía de nuestro almacén de Santa Coloma de Farners con embalaje de cartón no retornable.

11. FOTOGRAFÍAS, INFORMACIÓN Y MEDIDAS

Las fotografías, la información y las medidas indicadas en el catálogo del vendedor pueden sufrir cambios, sin previo aviso, debido a requisitos técnicos o de producción.

12. PROTECCIÓN DE DATOS PERSONALES

De conformidad con lo establecido en la normativa vigente en materia de protección de datos de carácter personal, VOLLRATH PUJADAS, S.A.U informa al comprador que los datos personales recogidos durante la relación comercial serán tratados e incorporados en los ficheros del vendedor, con el objetivo de poder prestar los servicios solicitados, así como también para mantenerlo informado de nuevos productos y servicios. Los datos facilitados se conservarán mientras se mantenga la relación comercial y una vez finalizada se conversarán aquellos que vengan exigidos por la legislación tributaria. En cualquier momento usted podrá ejercer los derechos de acceso, rectificación o supresión, limitación del tratamiento, portabilidad y oposición mediante una petición escrita a info@pujadas.es, acompañada de una fotocopia de su DNI/NIF. También podrá dirigirse a la Autoridad de Control competente para presentar la reclamación que considere oportuna.

Quedan reservados todos los derechos de cambio sin aviso previo, en especial colores o precios para los artículos que aparecen en este catálogo.

Fotografías no contractuales.

Conditions generales de vente

français

1. DISPOSITIONS APPLICABLES.

Toutes les ventes réalisées par PUJADAS – A Vollrath Company (“Le Vendeur”) sont soumises à ces termes et conditions générales, et sont expressément conditionnées à l’acceptation de ces termes et conditions générales. Aucune modalité ou conditions générales différentes ou supplémentaires ne s’imposeront au Vendeur, sauf accord stipulé par écrit. Le vendeur s’oppose à l’ajout de modalités et de conditions différentes et informe l’acheteur que le Vendeur n’est pas disposé à vendre ses produits sous tout autre terme que ces termes et conditions. **Chaque contrat de vente, incluant ces termes et conditions constituera l’accord intégrale entre le Vendeur et l’acheteur, et sera régi par, et interprété conformément aux lois espagnoles, sans égard à aucun principe de conflit de lois. Les droits et obligations des Parties au contrat ne seront pas régis par la Convention 1980 des Nations Unies sur les Contrats de Vente Internationale de marchandise ; et les deux parties au contrat se soumettent expressément à la juridiction des tribunaux de Barcelone (Espagne) pour toute procédure décollant ou en relation avec les présentes conditions générales de vente.** Il n’y a pas de conditions affectant l’accord entre les deux parties au contrat qui ne sont pas exprimés dans ces termes et conditions.

2. TAXES AND AUTRES FRAIS

Toute taxe de fabricant, taxe d’occupation, taxe d’utilisation, taxe de vente, taxe d’accise, taxe sur la valeur ajoutée, droit de douane, taxe d’inspection ou d’examen, ou toute autre taxe, frais, intérêts ou frais de quelque nature que ce soit imposés par une autorité gouvernementale ou mesures pour la transaction entre le Vendeur et l’acheteur doit être payé par l’acheteur en plus du prix estimé ou facturé. Dans l’éventualité où le Vendeur serait tenu de payer de telles taxes ou autres frais, l’Acheteur devra les lui rembourser sur demande.

3. LIVRAISON ET FRET

Tous les articles sont livrés FCA point d’origine (Incoterms 2020). A l’exception des dispositions ci-dessous, les commandes effectuées depuis la péninsule et depuis les Iles Baléares avec une valeur supérieure à 500 € (1,400 € pour les îles Canaries) pour d’expéditions à un unique destin seront expédiées PREPAID (PRÉPAYÉ) par le Vendeur. Les commandes d’une valeur inférieure à 500€ seront évaluées de frais de fret de 20€. (60€ aux Iles Canaries) Pour les commandes dont la destination finale est en dehors d’Espagne, les produits sont livrés FCA dock de chargement du Vendeur (ceci étant défini par les conditions d’expédition des Incoterms 2020).La livraison des produits au transporteur constituera la livraison à l’acheteur ; ce qui signifie qu’indépendamment des conditions d’expédition ou de paiement du fret, l’acheteur doit supporter tous les risques de perte ou de détérioration liés au transport. Le Vendeur se réserve le droit de procéder à la livraison en plusieurs envois, sauf si le contraire est expressément stipulé ci-inclus. Tous les envois multiples devront être facturés et payés séparément au moment de la facturation, sans tenir compte des livraisons ultérieures.

Le Vendeur se réserve le droit de propriété sur tous les produits fournis jusqu’au paiement complet de ces derniers.

a. Montant minimum de la commande et commandes Drop Ship

Des frais minimums de 6 € seront appliqués aux commandes inférieures à 100 € NET.

Le Vendeur se réserve le droit de refuser des demandes de dropshipping pour les mêmes produits à destination d’une ou plusieurs localités.

b. Quantité

Les matériaux seront fournis dans un emballage complet contenant la quantité indiqué dans nos tarifs.

c. Ustensiles personnalisés

Les commandes d’ustensiles personnalisés sont complétées avec des envois inférieurs ou supérieurs, ne dépassant pas plus ou moins 10% de la comande originale.

4. RÉCLAMATIONS, RETARDS ET FORCE MAJEURE

En aucun cas, les réclamations concernant l’état de la marchandise ou des erreurs de livraison ne seront acceptées une fois que 15 jours ouvrables se sont écoulés depuis leur réception.

Les réclamations pour manque de produits ou tout autre erreur de livraison doivent être faites par écrit au Vendeur dans les 15 jours ouvrables suivant la réception de la marchandise. L’omission de donner un tel avis constituera une acceptation sans réserve et une renonciation à toute réclamation ultérieure de l’acheteur. **Les réclamations pour perte ou détériorations sont à effectuer auprès du transporteur et non de l’acheteur. NOTRE RESPONSABILITÉ QUAND AU TRANSPORT CESSE APRÈS ACCEPTATION DU TRANSPORTEUR.**

Toutes les dates de livraison sont approximatives. Le retard d’une livraison ne libère pas l’acheteur de son obligation d’accepter les envois restants. En outre, Le Vendeur ne serait pas être tenu responsable des pertes ou des dégradations résultant d’un retard ou d’un défaut de livraison en raison de circonstances ou d’évènements indépendants de la volonté du Vendeur, incluant sans s’y limiter tout acte de Dieu, d’actes émanant de l’acheteur, d’actes gouvernementaux, de règlements ou demandes, feu, accident, grève, ralentissement, guerre, acte de terrorisme, émeute, retard dans le transport, incapacité d’un travailleur, défaillance du matériel ou des installations du fabriquant. En cas de retard, la date de livraison est prolongée pour une période égale au temps perdu en raison du retard. Le recours exclusif de l’acheteur pour d’autres retard et pour l’incapacité du Vendeur à livrer la marchandise peut être l’annulation du contrat d’achat.

5. MODIFICATIONS

Le Vendeur peut à tout moment effectuer des changements concernant la conception ou la construction des produits, des composants ou de pièces si le Vendeur les juge appropriés, sans le notifier à l’Acheteur. Le Vendeur peut fournir des substituts appropriés pour les matériaux impossibles de se procurer à cause de priorités ou de règlements imposés par une autorité gouvernementale ou en cas de non disponibilités des matériaux auprès des fournisseurs.

6. GARANTIES

Le vendeur garantit que tous les produits fournis en vertu des présentes CGV sont exempts de non-conformité aux spécifications ci-jointes, et sans défauts de fabrications apparaissant dans les 60 jours. Le vendeur garantit également que tous les équipements fournis en vertu des présentes CGV sont exempts de non-conformité aux spécifications ci-jointes, et sans défauts de fabrications apparaissant dans les 18 mois suivant le date d’envoi ou dans les 12 mois suivant la date d’achat de l’utilisateur final, qui se termine plus tôt. Si au cours de ces périodes il était prouvé au Vendeur que les produits sont défectueux, la part correspondante serait remplacée gratuitement, FCA destination initiale de l’acheteur, ou le Vendeur rembourserait le prix d’achat de la part affectée. Une telle réparation, remplacement ou remboursement (que le Vendeur détermine et accepte à son gré) représente l’unique obligation du Vendeur et le recours exclusif de l’acheteur pour de tels défaut pour des produits fournis dans le cadre de ces conditions générales de vente, et est conditionné au retour des produits par l’acheteur au Vendeur, DDP au dock d’expédition du Vendeur (ceci étant défini par les conditions d’expédition des Incoterms 2020). Toute pièce réparé ou remplacé dans le cadre de cette garantie est garantie seulement sur le solde de la période de garantie de la pièce réparée ou remplacée. Le vendeur ne garantit aucun produit endommagé par accident, négligence, mauvaise installation, manque de maintenance (le cas échéant) ou installation ou utilisation contraires aux instructions d’installation et d’utilisation. Le vendeur n’offre aucune garantie sur les services de réparation effectués par du personnel non autorisé ou des agences non autorisées.

LES GARANTIES CI-DESSUS SONT EXCLUSIVES ET EN LIEU ET PLACE DE TOUTES AUTRES REPRESENTATIONS OU GARANTIES, EXPRESSES OU IMPLICITES, ET LE VENDEUR DECLINE ET EXCLUT TOUTE GARANTIE IMPLICITE DE QUALITE MARCHANDE OU D’ADAPTATION A UN USAGE PARTICULIER, ET TOUTE GARANTIE POUVANT DECOULER DE RAPPORTS D’AFFAIRES OU DE PRATIQUES COMMERCIALES.

français

7. RÉSILIATIONS ET RENVOIS

Ningún pedido podrá ser cancelado ni modificado por el comprador. Aucune commande ne saurait être annulée ou modifiée par l’acheteur excepté dans le cadre des termes et conditions acceptables pour le Vendeur, et avec le consentement écrit de ce dernier.

Des Autorisations de Renvoi doivent être sollicitées pour tout renvoi.

Les produits renvoyer sans autorisation préalable de la part des bureaux du Vendeur à Santa Coloma de Farners **SERONT REFUSÉS.** PUJADAS est libre d’autoriser le renvoi et peut décider de refuser le renvoi sur critères propres.

a. Les demande de renvoi de marchandise (pour un motif autre que produits défectueux) doivent être faites dans les 90 JOURS suivant la DATE DE FACTURATION par PUJADAS. LE NUMÉRO DE COMANDE ou LE NUMÉRO DE LA FACTURE DOIT ÊTRE FOURNI pour une demande d’autorisation. AUCUNE AUTORISATION DE RENVOI ne sera émise si le numéro de commande ou le numéro de facture n’est pas fourni.

b. Des frais de restockage s’appliquent de la façon suivante :

1. Marchandise d’une valeur inférieure à 50€– 10 € de frais de restockage.

2. Marchandise d’une valeur supérieure à 50 € - 20% comme frais de restockage.

c. Les renvois ou les envois de produit à destination des installations de PUJADAS pour des raisons de paiement, de remplacement ou de réparation devraient toujours être effectués en fret payé d’avance.

d. Le Numéro de l’Autorisation de Retour doit être indiqué sur tous les cartons retournés.

e. Les renvois sont acceptés uniquement pour les produits actuels, trouvé dans leurs cartons d’origine, à l’état de neuf et pouvant être revendu. Les produits renvoyer, s’ils sont usés, obsolètes ou présentent des marques de manipulation seront élimés et le crédit NE SERA PAS émis.

1. Le renvoi de RAYONNAGE devra uniquement être effectué dans son emballage complet et original, sur palette s’il s’agit de plus d’un emballage, et parfaitement protégé.

2. Le renvoi de CHARIOTS doit être effectué sur palette et avec l’emballage de protection complet.

f. Les produits suivants ne peuvent pas être renvoyé : (1) Les ustensiles personnalisés, (2) casiers à vaisselle Traex, (3) produits personnalisés.

Le renvoi de produits pour lesquels PUJADAS a dû faire des adaptations pour honorer une demande, ne se pas accepté non plus.

8. BREVETS, MARQUE DÉPOSÉE ET COPYRIGHTS

Le vendeur défendra, à ses frais, tout procès qui pourrait être engagé par un tiers contre l’Acheteur pour la présumée violation d’un brevet, d’une marque déposée ou d’un copyright de l’Union Européenne en relation avec des produits ou des services fournis par le Vendeur, et il paiera toute indemnité finale en cas de dommage et intérêts, à condition que l’Acheteur ait effectué tous les paiement dus, l’acheteur devra immédiatement informer par écrit le Vendeur d’une telle poursuite, il devra de façon immédiate transmettre au Vendeur et dès leur réception les procédures et les documents qui sont notifiés à l’acheteur et devra permettre au Vendeur, via son avocat, de défendre ou régler cette affaire soit au nom de l’acheteur soit au nom du Vendeur, en donnant au Vendeur toutes les informations nécessaires, l’assistance et l’autorité pour lui permettre de le faire. En outre si le résultat d’un tel procès est une condamnation ou la reconnaissance d’une infraction, le Vendeur devra, à l’option du Vendeur (a) obtenir pour l’acheteur le droit de continuer à faire usage des produits ou des services achetés au Vendeur ou (b) remplacer ces derniers par des produits ou des services non litigieux, ou (c) modifier ces produits ou ces services de façon à ce qu’ils ne soient plus litigieux, ou (d) retirer ces produits ou services et rembourser à l’acheteur une valeur inférieure au prix d’achat déterminé en se basant sur une durée de vie utile de 5 ans.

Dans la mesure où tous les produits ou services fournis à l’acheteur par le Vendeur sont fabriqués conformément aux dessins, aux plans ou aux spécificités proposés ou fournis par l’acheteur, le Vendeur ne sera pas responsable, et l’acheteur devra indemniser et décharger le Vendeur pour et contre toute sorte de perte, d’en-cours, de dommages et intérêts, de réclamations et de dépenses (notamment, mais sans s’y limiter les honoraires engagés par le Vendeur pour sa défense et les autres coûts liés à sa défense) engagés par le Vendeur à la suite d’une réclamation pour atteinte au brevet, à la marque déposée, au copyright ou a une atteinte au secret commercial, ou pour tout autre violation du droit de propriété d’un tiers.

Conditions generales de vente

9. DOMMAGES CONSÉCUTIFS ET AUTRES RESPONSABILITÉS ; INDEMNITÉ

La responsabilité du vendeur à l’égard des produits et des services vendus en vertu des conditions présentes est limitée aux garanties et aux indemnités prévues aux articles 7 et 9 des présentes conditions générales de vente et, en ce qui concerne tout autre manquement au contrat qu’il a avec l’acheteur, l’indemnité est limitée au montant du contrat. **LE VENDEUR N’EST SOUMIS A AUCUNE AUTRES OBLIGATIONS OU RESPONSABILITES, DECOULANT D’UNE VIOLATION DU CONTRAT, DE GARANTIES, DE TORTS (INCLUANT LES NEGLIGENCES OU LES RESPONSABILITES STRICTES) OU DANS LE CADRE D’AUTRES THEORIES LEGALES, RELATIVES AUX PRODUITS ET AUX SERVICES VENDUS PAR LE VENDEUR, OU TOUT AUTRE ENGAGEMENT OU OMISSION RELATIF EN CELA.**

Sans limiter la portée de ce qui précède, le vendeur décline expressément toute responsabilité pour les dommages matériels, les pénalités, les dommages spéciaux ou punitifs, les dommages pour la perte de profits ou de revenus, les pertes de temps, la perte de survaleur, le coût du capital, le coût de produits de substitution, ou pour tout autre perte d’un avantage économique ou pour les réclamations des clients de l’acheteur ou tout autre tiers pour de tels dommages, coûts ou pertes.

LE VENDEUR NE SERA PAS RESPONSABLE ET REJETTE TOUS LES DOMMAGES CONSÉCUTIFS, ACCESSOIRES, INDIRECTS ET ÉVENTUELS.

L’acheteur devra indemniser et décharger le Vendeur pour et contre toute sorte de perte, d’en-cours, de dommages et intérêts, et de dépenses (notamment, mais sans s’y limiter les honoraires engagés par le Vendeur pour sa défense et les autres coûts liés à sa défense) que le Vendeur peut encourir à la suite d’une réclamation de l’acheteur ou d’un client de l’acheteur ou d’un tiers décollant ou en relation avec les produits ou les services vendus selon les modalités des présentes, à moins que ces pertes, en-cours, dommages et intérêts ou dépenses ne soient finalement attribué uniquement à la seule faute intentionnelle du Vendeur.

10. PRIX

Les prix de ventes sont ceux détaillés dans nos tarifs, faisant référence à la marchandise de notre entrepôt de Santa Coloma de Farners avec des emballages en carton non consignés.

11. PHOTOS, DONNÉES ET DIMENSIONS

Les photos, données et dimensions présentes dans le catalogue du Vendeur sont susceptibles d’être modifiées, sans notification préalable, en raison d’exigences techniques ou de production.

12. PROTECTION DES DONNÉES PERSONNELLES

Conformément à ce qu’établit la réglementation en vigueur en matière de protection de données à caractère personnel, VOLLRATH PUJADAS, S.A.U informe l’acheteur que les données personnelles collectées durant la relation commerciale seront traitées et stockées dans les fichiers du vendeur dans le but de pouvoir offrir les services requis ainsi que pour le tenir informé de nouveaux produits et services. Les données fournies seront conservées tant que durera la relation commerciale et, une fois celle-ci terminée, seules seront conservées celles exigées par la législation fiscale. À tout moment, vous pourrez exercer les droits d’accès, rectification ou suppression, limitation de traitement, portabilité et opposition moyennant demande par écrit adressée à info@pujadas.es, accompagnée d’une photocopie de votre numéro de pièce d’identité/ numéro d’identification fiscale. Vous pourrez aussi vous adresser à l’autorité de contrôle compétente pour présenter la réclamation que vous jugerez pertinente.

Tous les droits de modification sans avis préalable sont réservés, en particulier les couleurs ou les prix des articles figurant dans ce catalogue.

Photographies non contractuelles.

CPUJADAS2024



8 421661 616508

THE VOLLRATH COMPANY, L.L.C.

1236 North 18th street
Sheboygan, WISCONSIN 53081-3201 USA
Customer Service; 920.459.4851
Fax. 920.459. 6537
Credit: 920.459.5387

VOLLRATH PUJADASSAU

Ctra. de Castanyet, 132
17430 Santa Coloma de Farners
(GIRONA) - SPAIN
Tel. +34 972 84 32 01
info@pujadas.es

VOLLRATH SHANGHAI TRADING LIMITED

Room 906, Building A, Hongwell Plaza, No.1308
Lianhua Road, Minhang District
Shanghai, 201102 CHINA
Tel. 86-21-50589580

VOLLRATH DE MEXICO S. DER.L. DEC.V.

Periférico Sur edificio 2-C
Col. Santa María Tequepexpan
45601 Tlaquepaque, JALISCO MEXICO
Tel. (52) 333.133.6767 or (52) 333.133.6769
Fax. (52) 333.133.6768

VOLLRATH

www.vollrathfoodservice.com

©2023 The Vollrath Company, L.L.C.
An ISO 9001 Certified Company



www.stoeltingfoodservice.com



www.pujadas.es
www.pujadasgrill.com



An ISO 9001 Certified Company

